



MICROWAVE OVEN

CE745GR

SERVICE Manual

MICROWAVE OVEN

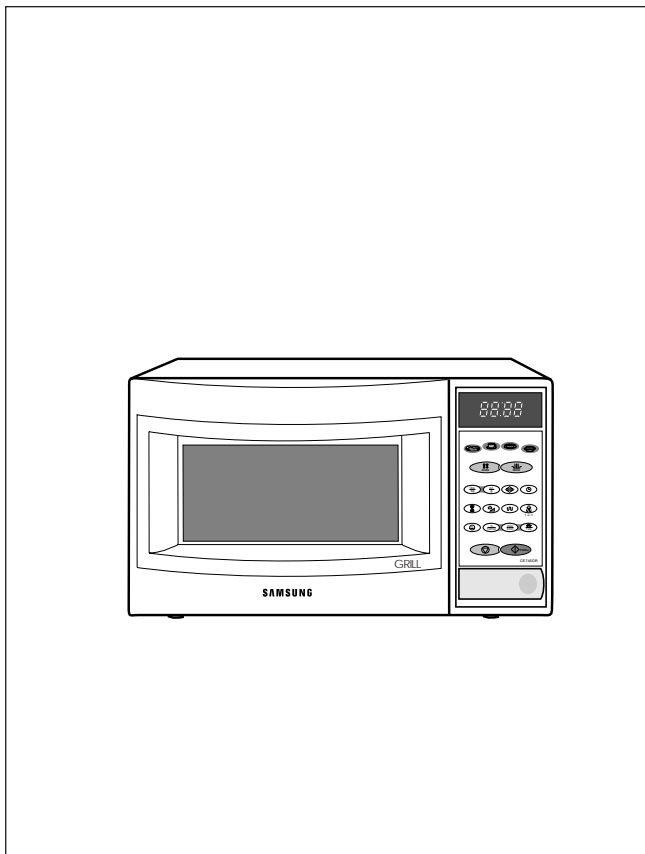

CONTENTS

1. Precaution
2. Specifications
3. Operating Instructions
4. Disassembly and Reassembly
5. Alignment and Adjustments
6. Troubleshooting
7. Exploded Views and Parts List
8. PCB Diagrams
9. Schematic Diagrams

BWT

PRECAUTIONS TO BE OBSERVED BEFORE AND DURING SERVICING TO AVOID POSSIBLE EXPOSURE TO EXCESSIVE MICROWAVE ENERGY

- (a) Do not operate or allow the oven to be operated with the door open.
- (b) Make the following safety checks on all ovens to be serviced before activating the magnetron or other microwave source, and make repairs as necessary:
 - (1) Interlock operation,
 - (2) proper door closing,
 - (3) seal and sealing surfaces (arcing, wear, and other damage),
 - (4) damage to or loosening of hinges and latches,
 - (5) evidence of dropping or abuse.
- (c) Before turning on microwave power for any service test or inspection within the microwave generating compartments, check the magnetron, wave guide or transmission line, and cavity for proper alignment, integrity, and connections.
- (d) Any defective or misadjusted components in the interlock, monitor, door seal, and microwave generation and transmission systems shall be repaired, replaced, or adjusted by procedures described in this manual before the oven is released to the owner.
- (e) A Microwave leakage check to verify compliance with the Federal performance standard should be performed on each oven prior to release to the owner.

1. Precaution

Follow these special safety precautions. Although the microwave oven is completely safe during ordinary use, repair work can be extremely hazardous due to possible exposure to microwave radiation, as well as potentially lethal high voltages and currents.

1-1 Safety precautions (⚠)

1. All repairs should be done in accordance with the procedures described in this manual. This product complies with Federal Performance Standard 21 CFR Subchapter J (DHHS).
2. Pacemaker wearers must consult a physician before attempting to service an MWO.
8. Notify the Central Service Center if the microwave leakage exceeds 5 mw/cm^2
4. Check all grounds.
5. Do not power the MWO from a "2-prong" AC cord. Be sure that all of the built-in protective devices are replaced. Restore any missing protective shields.
6. When reinstalling the chassis and its assemblies, be sure to restore all protective devices, including: nonmetallic control knobs and compartment covers.
7. Make sure that there are no cabinet openings through which people--particularly children--might insert objects and contact dangerous voltages. Examples: Lamp hole, ventilation slots.
8. In the event of suspected microwave energy leakage in excess of $5 \text{ mW/} \text{ } \ddagger \text{ } \ddagger$, please notify
**J.V.SAMSUNG SERVICE LTD.
MARSHAL ZHUKOU.,1.OFFICE 201
123308,MOSCOW,RUSSIA**
9. Service technicians should remove their watches while repairing an MWO.
10. To avoid any possible radiation hazard, replace parts in accordance with the wiring diagram. Also, use only the exact replacements for the following parts: Primary and secondary interlock switches, interlock monitor switch.
11. If the fuse is blown by the Interlock Monitor Switch: Replace all of the following at the same time: Primary and secondary switches, as well as the Interlock Monitor Switch. The correct adjustment of these switches is described elsewhere in this manual. Make sure that the fuse has the correct rating for the particular model being repaired.
12. Design Alteration Warning:
Use exact replacement parts only, i.e., only those that are specified in the drawings and parts lists of this manual. This is especially important for the Interlock switches, described above. Never alter or add to the mechanical or electrical design of the MWO. Any design changes or additions will void the manufacturer's warranty.10.Always unplug the unit's AC power cord from the AC power source before attempting to remove or reinstall any component or assembly.
13. Never defeat any of the B+ voltage interlocks. Do not apply AC power to the unit (or any of its assemblies) unless all solid-state heat sinks are correctly installed.
14. Some semiconductor ("solid state") devices are easily damaged by static electricity. Such components are called Electrostatically Sensitive Devices (ESDs). Examples include integrated circuits and field-effect transistors.

Immediately before handling any semiconductor components or assemblies, drain the electrostatic charge from your body by touching a known earth ground.
15. Always connect a test instrument's ground lead to the instrument chassis ground *before* connecting the positive lead; always remove the instrument's ground lead last.

1-2 Special Servicing Precautions (Continued)

16. When checking the continuity of the witches or transformer, always make sure that the power is OFF, and one of the lead wires is disconnected.
17. Components that are critical for safety are indicated in the circuit diagram by shading, ▲ or ▲ .
18. Use replacement components that have the same ratings, especially for flame resistance and dielectric strength specifications. A replacement part that does not have the same safety characteristics as the original might create shock, fire or other hazards.

1-3 Special High Voltage Precautions

1. High Voltage Warning
Do not attempt to measure any of the high voltages--this includes the filament voltage of the magnetron. High voltage is present during any cook cycle.

Before touching any components or wiring, always unplug the oven and discharge the high voltage capacitor (See Figure 1-1)
2. The high-voltage capacitor remains charged about 30 seconds after disconnection. Short the negative terminal of the high-voltage capacitor to the oven chassis. (Use a screwdriver.)
3. High voltage is maintained within specified limits by close-tolerance, safety-related components and adjustments. If the high voltage exceeds the specified limits, check each of the special components.

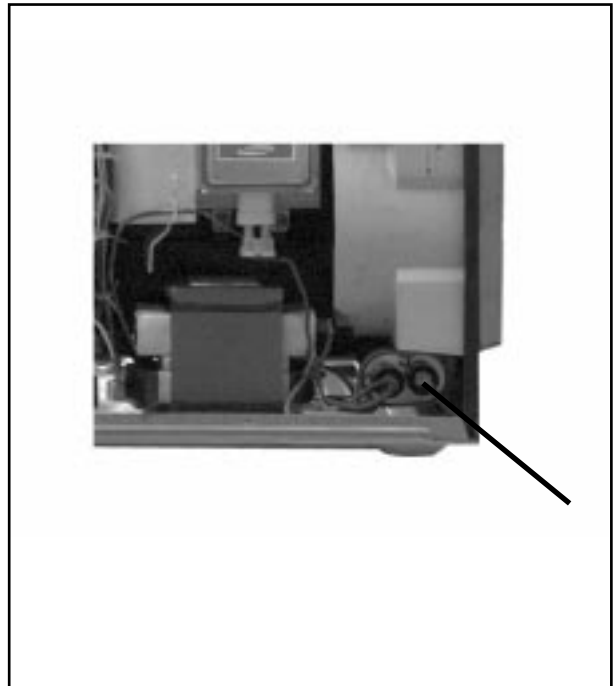

Fig. 1-1. Discharging the High Voltage Capacitor

2. Specifications

2-1 Table of Specifications

ITEM	MODEL	CE745GR
TIMER		99 MINUTES 90 SECONDS
POWER SOURCE		230V/50HZ, AC
POWER CONSUMPTION		MICROWAVE : 1,400W, GRILL : 1100W
OUTPUT POWER		FROM 85 TO 850W (10 LEVEL POWER) (IEC-705 TEST PROCEDURE)
OPERATING FREQUENCY		2,450MHz
MAGNETRON		OM75PH(31)
COOLING METHOD		COOLING FAN MOTOR
OUTSIDE DIMENSIONS		19 ¹ / ₄ "(W) x 10 ²⁷ / ₃₂ "(H) x 14 ³ / ₈ "(D)
NET WEIGHT		36.3 LBS.
SHIPPING WEIGHT		39.6 LBS.

2-2 Comparison Chart

FEATURE	MODEL	CE745GR
MORE/LESS		○
AUTO REHEAT		○
AUTO DEFROST		○
TIME COOK		○
POWER LEVEL		○
INSTANT COOK		○
MEMORY		○
BOOST		-
CHILD LOCK		○
CLOCK		○
GRILL		○
COMBI		○

3. Operating Instructions

3-1 Control Panel

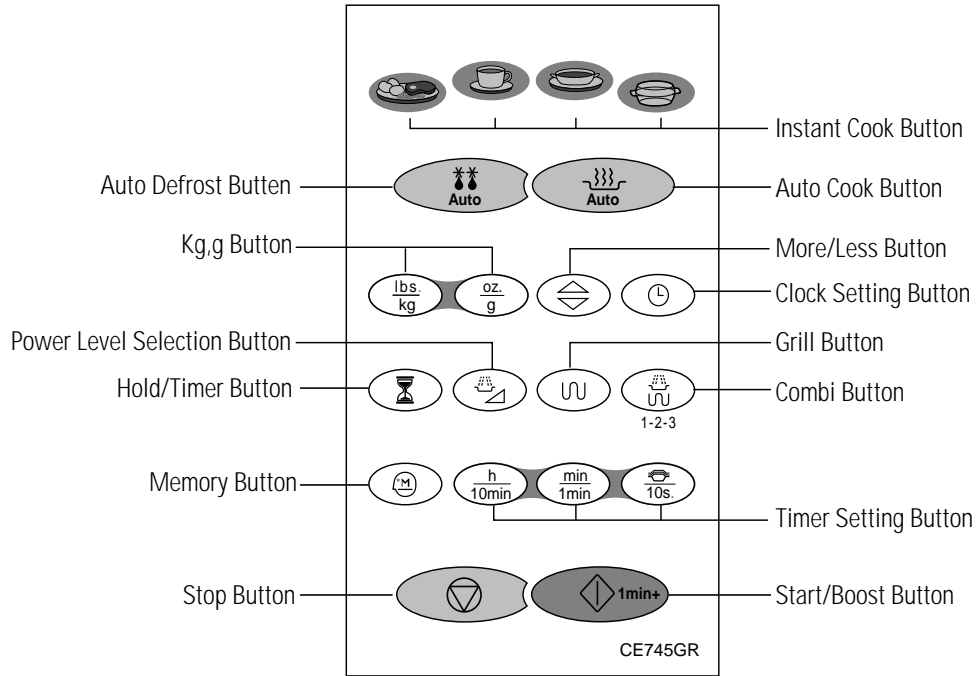

3-2 Features & External Views

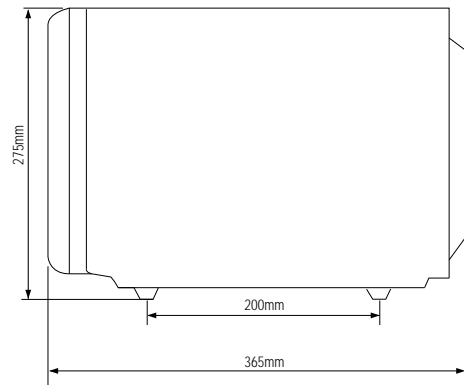
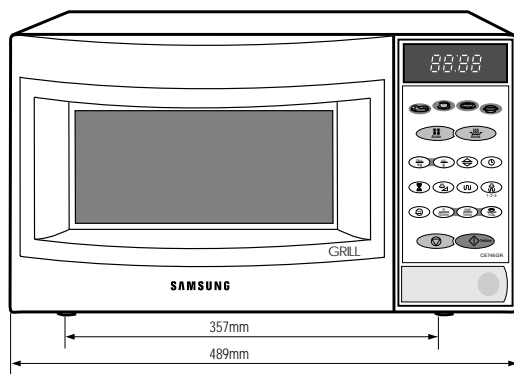
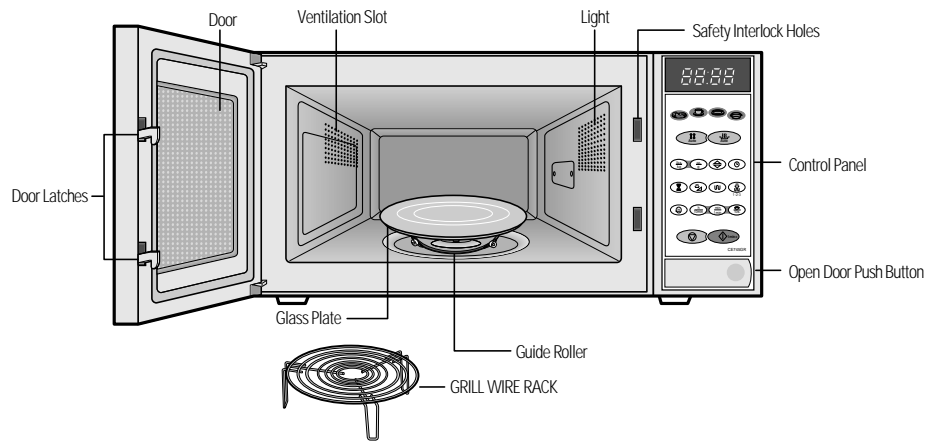

4. Disassembly and Reassembly

4-1 Replacement of Magnetron, Motor Assembly and Lamp

Remove the magnetron including the shield case, permanent magnet, choke coils and 500pF capacitors (all of which are contained in one assembly).

1. Disconnect all lead wires from the magnetron and lamp.
2. Remove the bracket mounting.
3. Remove the air cover.
4. Remove screws securing the magnetron to the wave guide.
5. Take out the magnetron very carefully.
6. Remove screws from the back panel.
7. Remove theassy noise filter.
8. Take out the fan motor.
9. Remove the oven lamp by pulling out from hole of air cover carefully.
10. NOTE1: When removing the magnetron, make sure that its antenna does not hit any adjacent parts, or it may be damaged.
11. NOTE2: When replacing the magnetron, be sure to remount the magnetron gasket in the correct position and make sure the gasket is in good condition.

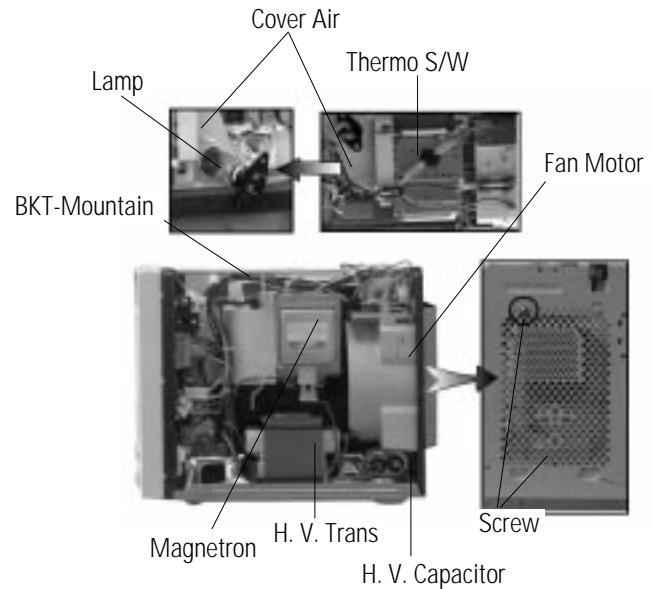

4-2 Replacement of High Voltage Transformer

1. Discharge the high voltage capacitor.
2. Disconnect all the leads.
3. Remove the mounting bolts.
4. Reconnect the leads correctly and firmly.

PRECAUTION

Servicemen should remove their watches whenever working close to or replacing the magnetron.

PRECAUTION

There exists HIGH VOLTAGE ELECTRICITY with high current capabilities in the circuits of the HIGH VOLTAGE TRANSFORMER secondary and filament terminals. It is extremely dangerous to work on or near these circuits with the oven energized. DO NOT measure the voltage in the high voltage circuit including filament voltage of magnetron.

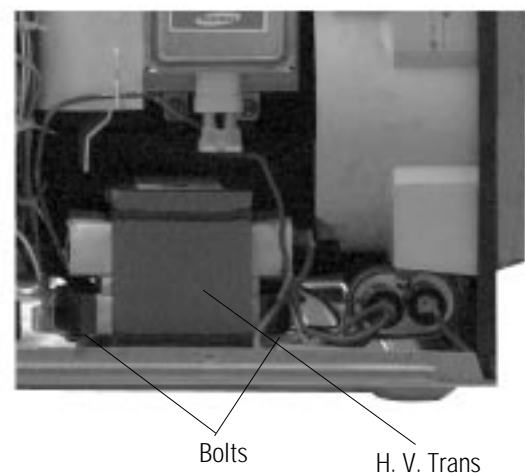

4-3 Replacement of Door Assembly

4-3-1 Removal of Door Assembly

Remove screws securing the upper hinge and lower hinge. Then remove the door assembly.

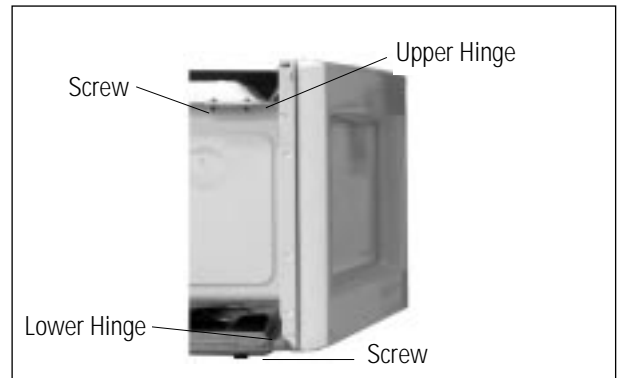

4-3-2 Removal of Door "C"

Insert flat screwdriver into the gap between Door "A" and Door "C" to remove Door "C". Be careful when handling Door "C" because it is fragile.

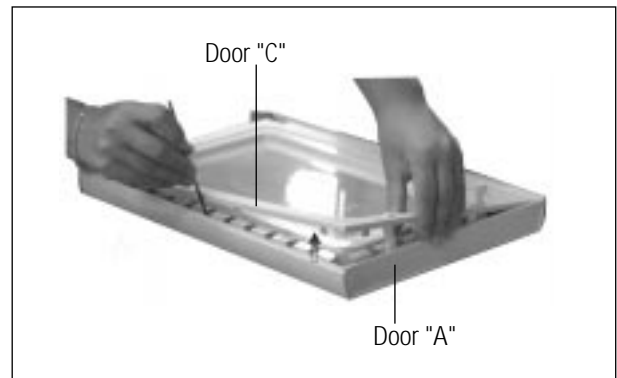

4-3-3 Removal of Door "E"

Following the procedure as shown in the figure, insert and bend a thin metal plate between Door "E" and Door "A" until you hear the 'tick' sound.

1. Insertion depth of the thin metal plate should be 0.5mm or less.

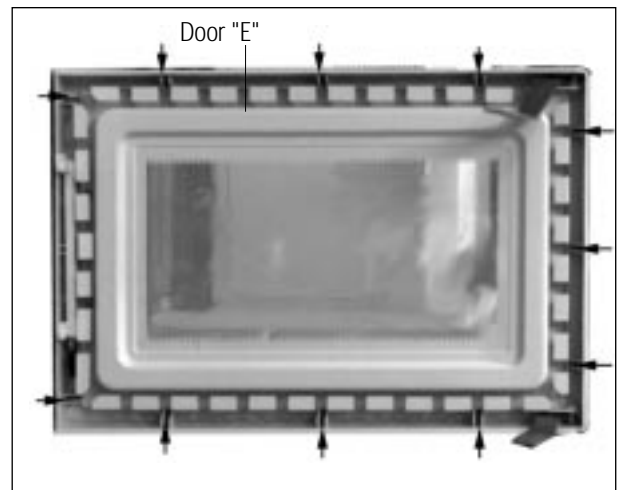

4-3-4 Removal of Key Door & Spring

1. Remove pin hinge from Door "E"
Detach spring from Door "E" and key door.
2. After replacement of the defective component parts of the door, reassemble it and follow the instructions below for proper installation and adjustment so as to prevent an excessive microwave leakage.
3. When mounting the door to the oven, be sure to adjust the door parallel to the bottom line of the oven face plate by moving the upper hinge and lower hinge in the direction necessary for proper alignment.
4. Adjust so that the door has no play between the inner door surface and oven front surface. If the door assembly is not mounted properly, microwave energy may leak from the space between the door and oven.
5. Do the microwave leakage test.

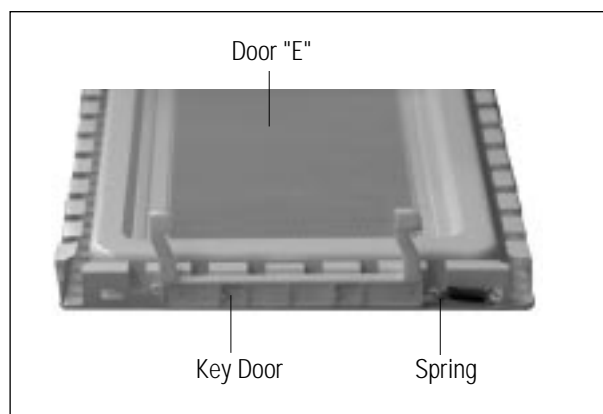

4-4 Replacement of Fuse

1. Disconnect the oven from the power source.
2. Remove the 10A fuse in the Noise filter.
3. When replacing the 10A fuse, be sure to use an exact replacement part. If new 10A fuse blows out again after replacement, check the primary interlock switch, door sensing switch and interlock monitor switch.
4. When the above three switches operate properly, check if any other part such as the control circuit board, blower motor or high voltage transformer is defective.

4-5 Replacement of Drive Motor

1. Take out the glass tray, guide roller and coupler from cavity.
2. Turn the oven upside down to replace the drive motor.
3. Remove a screw securing the drive motor cover.
4. Disconnect all the lead wires from the drive motor.
5. Remove screws securing the drive motor to the cavity.
6. Remove the drive motor.
7. When replacing the drive motor, be sure to remount it in the correct position.
8. Connect all the leads to the drive motor.
9. Screw the drive motor cover to the base plate with a screw driver.
10. Remount the coupler in the correct position.

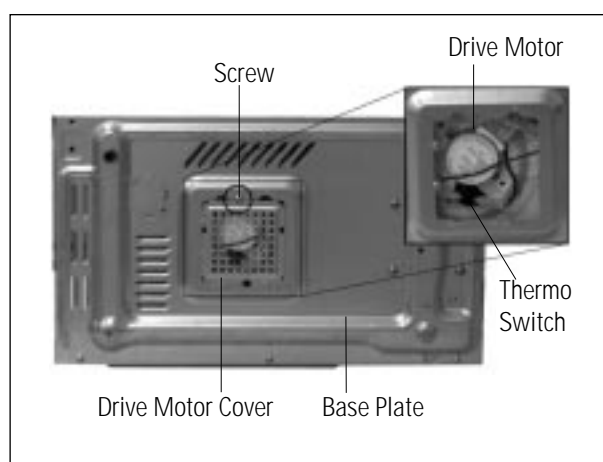

4-6 Replacement of Control Circuit Board

4-6-1 Removal of Control Box Assembly

1. Be sure to ground any static electric charge in your body and never touch the control circuit.
2. Disconnect the connectors from the control circuit board.
3. Remove screws securing the control box assembly.
4. Remove the screw securing the ground tail of the keyboard.

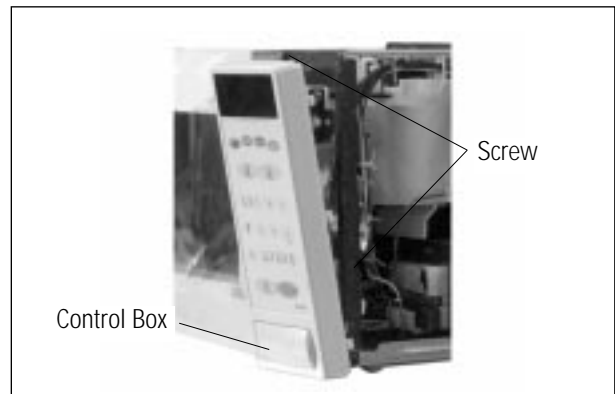

4-6-2 Removal of P.C.B Assembly

1. Pull the lever end of the plastic fastener and remove the Flexible Printed Circuit(FPC) of membrane panel.
2. Remove screws securing the control circuit board.
3. Lift up the control circuit board from the Ass'y control box.
4. When reconnecting the FPC connector, make sure that the holes on the connector are properly engaged with the hooks on the Plastic Fastener.

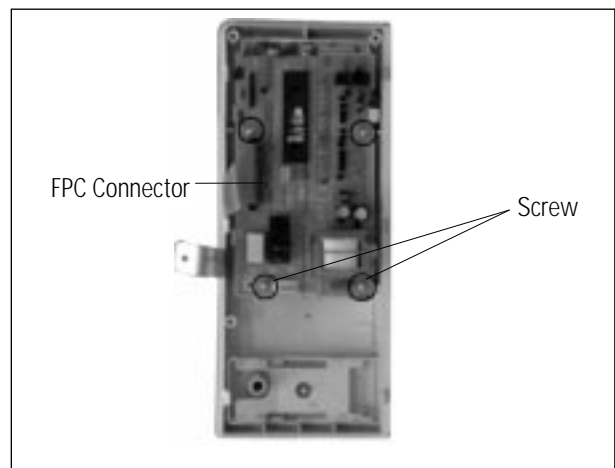

4-6-3 Removal of Window Display & Membrane Panel

1. Window display should not be disassembled as its mounting tabs will be broken. If repair work is difficult, replace with Ass'y control panel.
2. The membrane key board is attached to the escutcheon base with doublefaced adhesive tape. Therefore, applying hot air such as using of hair dryer is recommended for smoother removal.
3. When installing new membrane key board, make sure that the surface of escutcheon base is cleaned sufficiently so that any problems (shorted contacts or uneven surface) can be avoided.

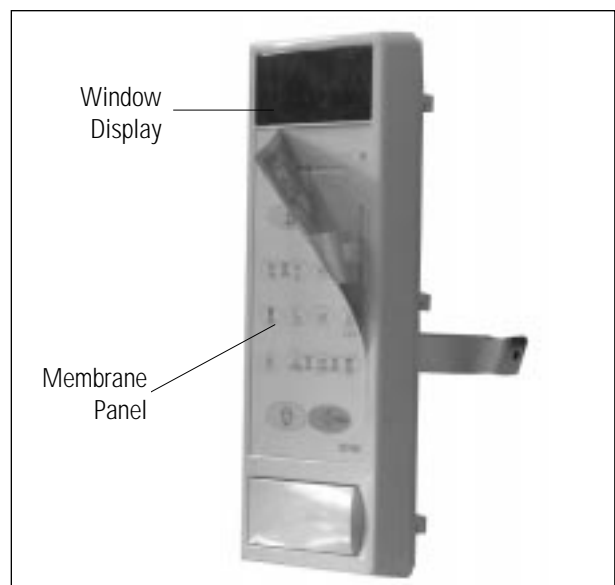

5. Alignment and Adjustments

PRECAUTION

1. High voltage is present at the high voltage terminals during any cook cycle.
2. It is neither necessary nor advisable to attempt measurement of the high voltage.
3. Before touching any oven components or wiring, always unplug the oven from its power source and discharge the high voltage capacitor.

5-1 High Voltage Transformer

1. Remove connectors from the transformer terminals and check continuity.
2. Normal resistance readings are as follows:

MODEL	CE745GR
Secondary	103.2Ω ; 10%
Filament	Shows Continuity
Primary	1.61Ω ; 10%

(Room temperature = 20°C)

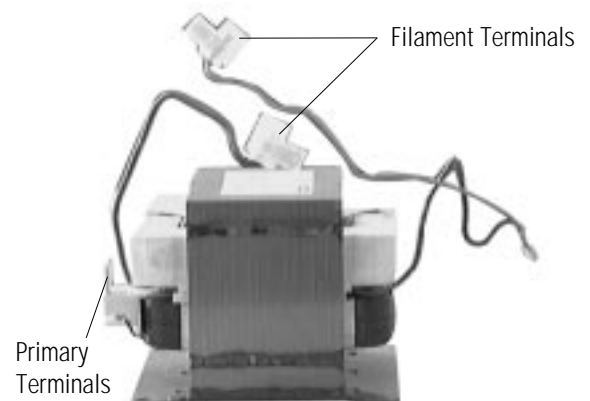

5-2 Low Voltage Transformer

1. The low voltage transformer is located on the control circuit board.
2. Remove the low voltage transformer from the PCB Ass'y and check continuity.
3. Normal resistor reading is shown in the table.

Terminals	Resistance
1-2(Input)	1149Ω
4-5(Output 17V)	12.26Ω
7-8(Output 2.9V)	2.574Ω

5-3 Magnetron

1. Continuity checks can indicate only an open filament or a shorted magnetron. To diagnose an open filament or shorted magnetron :
2. Isolate the magnetron from the circuit by disconnecting its leads.
3. A continuity check across the magnetron filament terminals should indicate one ohm or less.
4. A continuity check between each filament terminal and magnetron case should read open.

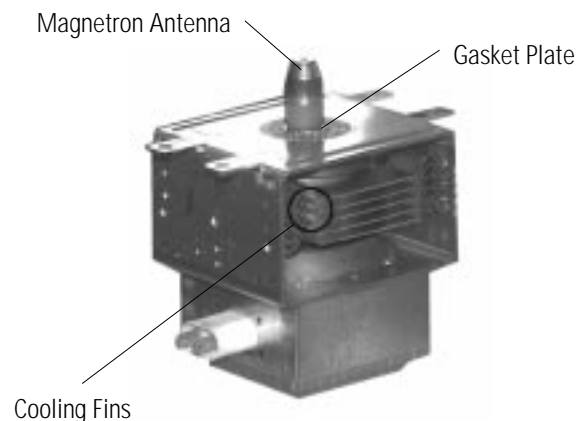

5-4 High Voltage Capacitor

1. Check continuity of the capacitor with the meter set at the highest resistance scale.
2. Once the capacitor is charged, a normal capacitor shows continuity for a short time, and then indicates 9MΩ.
3. A shorted capacitor will show continuous continuity.
4. An open capacitor will show constant 9MΩ.
5. Resistance between each terminal and chassis should read infinite.

5-5 High Voltage Diode

1. Isolate the diode from the circuit by disconnecting its leads.
2. With the ohm-meter set at the highest resistance scale, measure across the diode terminals. Reverse the meter leads and read the resistance. A meter with 6V, 9V or higher voltage batteries should be used to check the front-to back resistance of the diode (otherwise an infinite resistance may be read in both directions). The resistance of a normal diode will be infinite in one direction and several hundred KΩ in the other direction.

5-6 Main Relay and Power Control Relay

1. The relays are located on the PCB Ass'y. Isolate them from the main circuit by disconnecting the leads.
2. Operate the microwave oven with a water load in the oven. Set the power level set to high.
3. Check continuity between terminals of the relays after the start pad is pressed.

5-7 Adjustment of Primary Switch, Door Sensing Switch and Monitor Switch

Precaution

For continued protection against radiation hazard, replace parts in accordance with the wiring diagram and be sure to use the correct part number for the following switches: Primary and door sensing switches, and the interlock monitor switch (replace all together). Then follow the adjustment procedures below. After repair and adjustment, be sure to check the continuity of all interlock switches and the interlock monitor switch.

1. When mounting Primary switch and Interlock Monitor switch to Latch Body, consult the figure.
2. No specific adjustment during installation of Primary switch and Monitor switch to the latch body is necessary.
3. When mounting the Latch Body to the oven assembly, adjust the Latch Body by moving it so that the oven door will not have any play in it. Check for play in the door by pulling the door assembly. Make sure that the latch keys move smoothly after adjustment is completed. Completely tighten the screws holding the Latch Body to the oven assembly.
4. Reconnect to Monitor switch and check the continuity of the monitor circuit and all latch switches again by following the components test procedures.
5. Confirm that the gap between the switch housing and the switch actuator is no more than 0.5mm when door is closed.

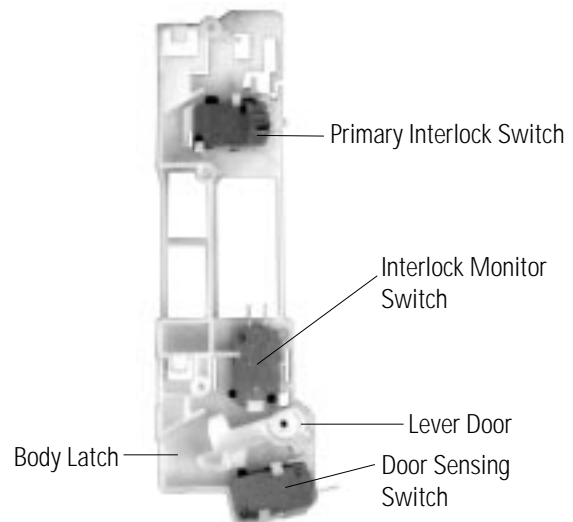

	Door Open	Door Closed
Primary switch	∞	0
Monitor switch (COM-NC)	0	∞
Door Sensing S/W	∞	0

5-8 Output Power of Magnetron

CAUTION MICROWAVE RADIATION

PERSONNEL SHOULD NOT ALLOW EXPOSURE TO MICROWAVE RADIATION FROM MICROWAVE GENERATOR OR OTHER PARTS CONDUCTING MICROWAVE ENERGY.

The output power of the magnetron can be measured by performing a water temperature rise test.

Equipment needed :

* Two 1-liter cylindrical borosilicate glass vessel (Outside diameter 190 mm)

* One glass thermometer with mercury column

NOTE: Check line voltage under load. Low voltage will lower the magnetron output. Make all temperature and time tests with accurate equipment.

1. Fill the one liter glass vessel with water.
2. Stir water in glass vessel with thermometer, and record glass vessel's temperature ("T1", 10±1°C).
3. After moving the water into another glass vessel, place it in the center of the cooking tray. Set the oven to high power and operate for 51seconds exactly. (2 seconds included as a holding time of magnetron oscillation:)
4. When heating is finished, stir the water again with the thermometer and measure the temperature ("T2").
5. Subtract T1 from T2. This will give you the water temperature rise. (ΔT)
6. The output power is obtained by the following formula;

$$\text{Output Power} = \frac{4.187 \times 1000 \times \Delta T + 0.88 \times Mc \times (T_2 - T_0)}{49.25}$$

49.25: Heating Time (sec)
4.187 : Coefficient for Water
1000 : Water (cc)
ΔT : Temperature Rise (T2-T1)
Mc : Cylindrical borosilicate glass weight
To : Room temperature.

7. Normal temperature rise for this model is 9°C to 11°C at 'HIGH'.

NOTE 1: Variations or errors in the test procedure will cause a variance in the temperature rise.

Additional power test should be made if temperature rise is marginal.

NOTE 2: Output power in watts is computed by multiplying the temperature rise (step 5) by a factor of 85 times the of centigrade temperature.

5 9 Leakage Measuring Procedure

5-9-1 Record keeping and notification after measurement

- 1) After adjustment and repair of a radiarion preventing device, make a repair record for the measured values, and keep the data.
- 2) If the radiation leakage is more than 5 mW/§† after determining that all parts are in good condition, functioning properly and the identical parts are replaced as listed in this manual notift that fact to ;

J.V.SAMSUNG SERVICE LTD.
MARSHAL ZHUKOU.,1.OFFICE 201
123308,MOSCOW,RUSSIA

5-9-2 At least once a year have the microwave energy survey meter checked for accuracy by its manufacturer.



5-10 Microwave Heat Distribution - Heat Evenness

The microwave heat distribution can be checked indirectly by measuring the water temperature rise at certain positions in the oven:

1. Prepare five beakers made of 'Pyrex', having 100 milliliters capacity each.
2. Measure exactly 100 milliliters of water load with a measuring cylinder, and pour into each beaker.
3. Measure the temperature of each water load. (Readings shall be taken to the first place of decimals.)
4. Put each beaker in place on the cooking tray as illustrated in figure below. Start heating.
5. After heating for 2 minutes, measure the water temperature in each beaker.
6. Microwave heat distribution rate can be calculated as follows:

$$\text{Heat Distribution} = \frac{\text{Minimum Temperature Rise}}{\text{Maximum Temperature Rise}} \times 100(\%)$$

The result should exceed 65%.

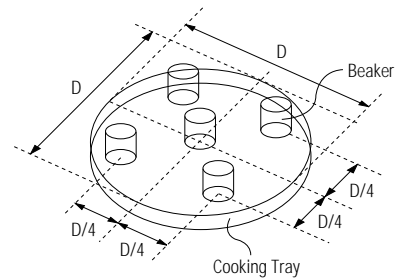

6. Troubleshooting

PRECAUTION

1. CHECK GROUNDING BEFORE CHECKING FOR TROUBLE.
2. BE CAREFUL OF THE HIGH VOLTAGE CIRCUIT.
3. DISCHARGE THE HIGH VOLTAGE CAPACITOR.
4. WHEN CHECKING THE CONTINUITY OF THE SWITCHES OR TRANSFORMER, DISCONNECT ONE LEAD WIRE FROM THESE PARTS AND THEN CHECK CONTINUITY WITHOUT THE POWER SOURCE ON. TO DO OTHERWISE MAY RESULT IN A FALSE READING OR DAMAGE TO YOUR METER.
5. DO NOT TOUCH ANY PART OF THE CIRCUIT OR THE CONTROL CIRCUIT BOARD, SINCE STATIC DISCHARGE MAY DAMAGE IT. ALWAYS TOUCH GROUND WHILE WORKING ON IT TO DISCHARGE ANY STATIC CHARGE BUILT UP.

6-1 Electrical Malfunction

SYMPTOM	CAUSE	CORRECTIONS
Oven is dead. Fuse is OK. No display and no operation at all.	<ol style="list-style-type: none"> 1. Open or loose lead wire harness 2. Open thermal cutout (Magnetron) 3. Open low voltage transformer 4. Defective Ass'y PCB 	<p>Check fan motor when thermal cutout is defective.</p> <p>Check Ass'y PCB when LVT is defective.</p>
No display and no operation at all. Fuse is blown.	<ol style="list-style-type: none"> 1. Shorted lead wire harness 2. Defective primary latch switch (NOTE 1) 3. Defective monitor switch (NOTE1) 4. Shorted HVCapacitor 5. Shorted HVTransformer (NOTE2) <p>NOTE 1: All of these switches must be replaced at the same time. (refer to adjustment instructions) Check continuity of power relay contacts and if it has continuity, replace power relay also.</p> <p>NOTE 2: When HVTransformer is replaced, check diode and magnetron also.</p>	<p>Check adjustment of primary, interlock monitor, door sensing switch.</p>
Oven does not accept key input (Program)	<ol style="list-style-type: none"> 1. Key input is not in-Sequence 2. Open or loose connection of membrane key pad to Ass'y PCB 3. Shorted or open membrane panel 4. Defective Ass'y PCB 	<p>Refer to operation procedure.</p> <p>Replace PCB main.</p>
Timer starts countdown but no microwave oscillation. (No heat while oven lamp and fan motor turn on.)	<ol style="list-style-type: none"> 1. Off-alignment of latch switches 2. Open or loose connection of high voltage circuit especially magnetron filament circuit <p>NOTE: Large contact resistance will bring lower magnetron filament voltage and cause magnetron to lower output and/or intermittent oscillation.</p> <ol style="list-style-type: none"> 3. Defective high voltage components H.V.Transformer H.V.Capacitor H.V.Diode,H.V.Fuse Magnetron 4. Open or loose wiring of power relay 5. Defective primary latch switch 6. Defective power relay or Ass'y PCB 	<p>Adjust door and latch switches.</p> <p>Check high voltage component according to component test procedure and replace if it is defective.</p> <p>Replace PCB main.</p>

6-1 Electrical Malfunction(continued)

SYMPTOM	CAUSE	CORRECTIONS
Oven lamp and fan motor turn on	<ol style="list-style-type: none"> Misadjustment or loose wiring of primary latch switch Defective primary latch switch 	Adjust door and latch switches.
Oven can program but timer does not start.	<ol style="list-style-type: none"> Open or loose wiring of secondary interlock switch Off-alignment of primary interlock Defective secondary interlock S/W 	Adjust door and interlock switches.
Microwave output is low;. Oven takes longer time to cook food.	<ol style="list-style-type: none"> Decrease in power source voltage. Open or loose wiring of magnetron filament circuit. (Intermittent oscillation)) Aging of magnetron 	Consult electrician.
Fan motor turns on when plugged in	Loose wiring of door sensing switch	Check wire of door sensing switch.
Oven does not operate and return to the plugged in mode.	Defective Ass'y PCB	Replace PCB main.
Loud buzzing noise can be heard.	<ol style="list-style-type: none"> Loose fan and fan motor Loose screws on H.V.Transformer Shorted H.V.Diode 	Tighten screws of fan motor. Tighten screws of H.V.Transformer. Replace H.V.Diode.
Turntable motor does not rotate.	<ol style="list-style-type: none"> Open or loose wiring of turntable motor. Defective turntable motor. 	Check the wire of turntable motor Replace turntable motor.
Oven stops operation during cooking	<ol style="list-style-type: none"> Open or loose wiring of primary interlock switch Operation of thermal cutout(Magnetron) 	Adjust door and latch switches.
Sparks	<ol style="list-style-type: none"> Metallic ware or cooking dishes touching on the oven wall. Ceramic ware trimmed with gold or silver powder also causes sparks. 	Inform the customer. Do not use any type of cookware with metallic trimming.
Uneven cooking	Uneven intensity of microwave due to its characteristics.	Wrap thinner parts of the food with aluminum foil. Use plastic wrap or cover with a lid. Stir once or twice while cooking foods such as soup, cocoa, or milk.
Noise from the turntable motor when it starts to operate.	Noise may result from the motor.	Replace turntable motor.

7. Exploded Views and Parts List

7-1 Exploded Views

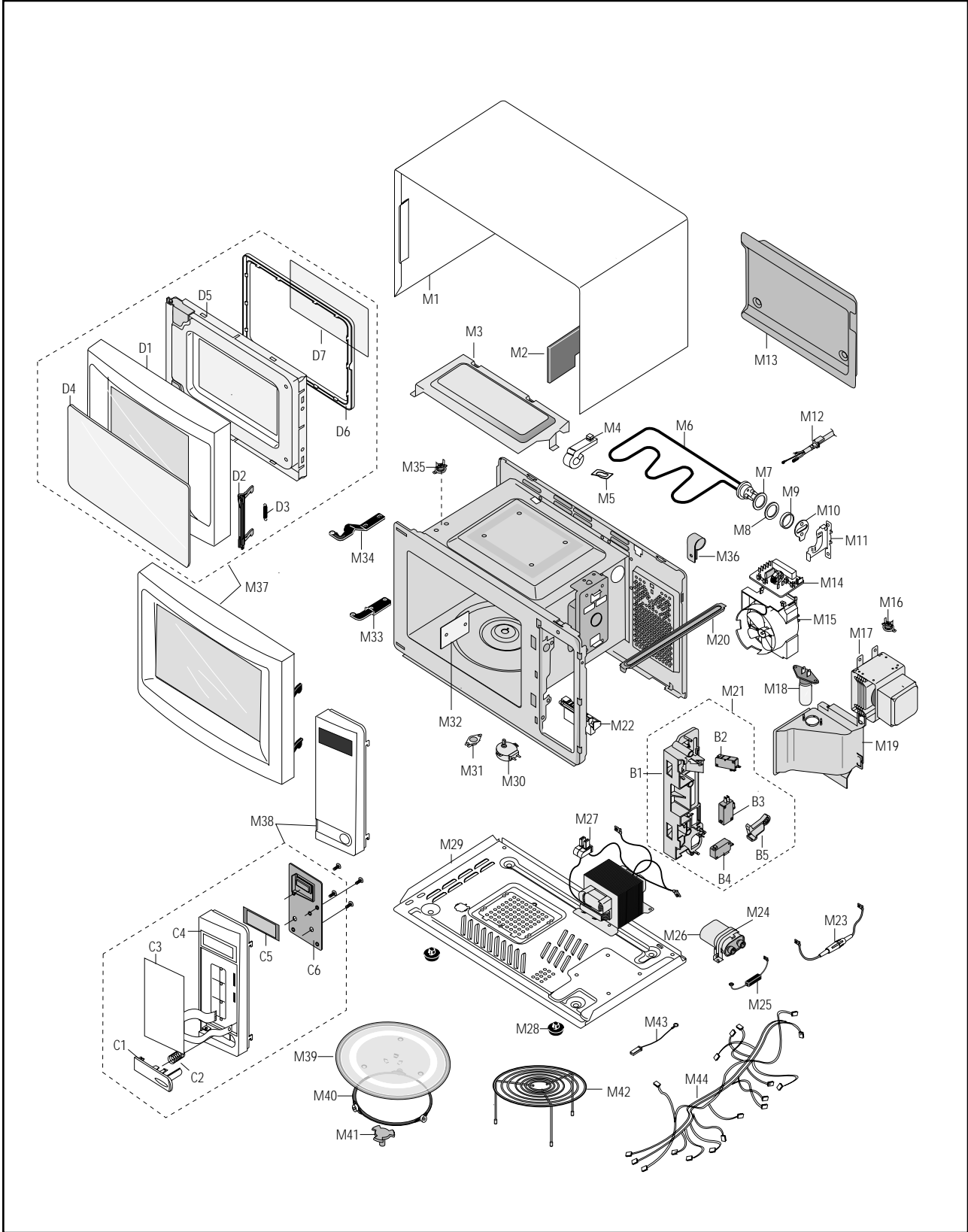

7-2 Main Parts List

Ref. No.	Parts No.	Description/Specification	Q'ty	Remarks	OLD PARTS NO.
M 1	DE70-30032X	PANEL-OUTER;T0.6 W351.2 L1010 WHT-COATIN	1	●	
M 2	DE63-90150A	CUSHION-RUBBER;DFA20 T2 W100 L140 BLK	1		
M 3	DE61-50323A	BRACKET-UPPER;ALSTAR T0.6 W385 L205 M624	1		73011-0243-00
M 4	DE61-30008A	SUPPORTER-HEATER;ALUMINA T12 CE745G	1		
M 5	DE61-70060A	SPRING-PLATE;SK-5 T0.5	1		76674-232-810
M 6	DE47-70072A	HEATER-GRILL;230V 1100W 47.OHM 6.25	1	● ▲	
M 7	DE60-40009B	WASHER-TEFLON;SLOT ID22.2 OD28 T1.2 TEFL	1		70534-0004-02
M 8	DE63-20017A	GASKET-HEATER;BRASS T1.5 OD30.5 ID22.5	1		73404-0014-00
M 9	DE61-50021A	BRACKET-FLANGE;SECC1 T0.8 32 32	1		
M 10	DE61-50027A	BRACKET-HEATER;BSS2-A T(1.0) W(51) L(55)	1		
M 11	DE61-50025A	BRACKET-EARTH;BSS2-A T1.0 CE745G	1		
M 12	DE39-20058C	ASSY POWER CORD;KKP-4819D/B232 250V16A L	1	●	
M 13	DE71-60298A	COVER-BACK;SECC T0.6 W273 L633 M6Q45	1		73312-0184-001
M 14	DE91-40095A	ASSY NOISE FILTER;SN-E10D(N) 250V 10A "2	1	●	
M 15	DE31-30031A	FAN-MOTOR;SMF745EA 230V/50HZ ASSY-FAN-MO	1	●	
M 16	DE47-20009A	THERMOSTAT;CS-7SA(160/60)187Y 250V7.5A 1	1		
M 17	DE03-30035A	MAGNETRON;OM75PH(31)ESS	1	● ▲	77059-0034-00
M 18	4713-001004	LAMP-INCANDESCENT;230V,-,40W,ORG,-,-,25x	1		
M 19	DE71-60010A	COVER-AIR;PP(TB53) T1.7 WHT 64G M745	1	●	
M 20	DE61-50129A	BRACKET-MOUNTING;SECC T0.8 W24 L316 M624	1		73013-0342-00
M 21	DE93-20001A	ASSY BODY LATCH;2ND-W1 M97G45/M9745	1		
M 22	DE66-90013A	LEVER-DOOR;POM(F20-01) NTR MW5630T	1		71533-0015-00
M 23	DE91-70061B	ASSY-H.V.FUSE;THV060T-0750-H 5KV0.75A RE	1		79163-0252-01
M 24	DE61-50106A	BRACKET-HVC;SECC T0.8 W31 L125.8	1		73013-0194-00
M 25	DE91-70065A	ASSY-HVD;BMP28 SEMA 12KV SUMI	1		79169-0153-00
M 26	2501-001014	C-OIL;HCH212105C 1.05UF,2100V 35X54X85,2	1		
M 27	DE26-10099A	TRANS-H.V;SHV-745EG1 230V 50HZ 2200V DPC	1	● ▲	
M 28	DE61-40017A	FOOT;PP(A353) BLK MW5630T	2		73004-0007-00
M 29	DE80-10003A	BASE-PLATE;SGCC1-Z T0.8 W340 L550 M745	1		
M 30	DE31-10154A	MOTOR-DRIVE;M2HJ49ZR02,ST-16 21V 5/6	1		
M 31	DE47-20008A	THERMOSTAT;CS-7S(100/60)187Y 250V7.5A 10	1		
M 32	DE71-60013A	COVER-CEILING;MICA T0.5 W52 L118 CE745G	1		
M 33	DE61-80004A	HINGE-LOWER;SCP1 T2.3 ZN-COATING BLK	1		
M 34	DE61-80005A	HINGE-UPPER;SCP1 T2.3 BLK ZN-COATING	1		
M 35	DE47-20174A	THERMOSTAT;NT-101NA 8XH 120 110 23.8MM	1		
M 36	DE65-20014A	CABLE CLAMP;DA-6N NY-66	1		76449-0003-00
M 37		ASSY DOOR;PUSH WHT CE745GR	1	● ▲	
M 38		ASSY CONTROL-BOX;230V-50HZ CE745GR(CIS)	1	● ▲	
M 39	DE74-20102B	TRAY-COOKING;GLASS T5.0 PI288 780G M745	1		
M 40	DE92-90436A	ASSY-GUIDE ROLLER;MW4370W	1		
M 41	DE67-60002A	COUPLER;PPS 5GR BRN M97G45	1		
M 42	DE74-70071A	RACK-WIRE;MSWR3 PI3 PI230 HI80 SNC2	1		
M 43	DE39-40409A	ASSY WIRE HARNESS-E;230V50HZ M9G45 CTW	1		79204-0381-00
M 44	DE39-40568A	ASSY WIRE HARNESS-A;230V50HZ CE745G/CE94	1	●	

● : Option Parts

▲ : Warning

▲ :Electrostatically Sensitive Devices

7-3 Door Parts List

Ref. No.	Parts No.	Description/Specification	Q'ty	Remarks	Old Parts No.
D 1	DE64-40007A	DOOR-A;ABS(VH-080) T3.0 WHT	1	●	72724-0040-00
D 2	DE64-40006A	DOOR-KEY;POM(TC3005) T2.0 12GR BLK CE9	1	●	
D 3	DE61-70033A	SPRING-KEY;ES HSWR10 PI0.6 D6.0 L22.3 BL	1		
D 4	DE67-20004D	SCREEN-DOOR;PC T1.5 W173.6 L373.5 WHT CE	1	● ▲	
D 5	DE92-50126B	ASSY DOOR-E;COATING BLK CE745G	1	●	
D 6	DE64-40008B	DOOR-C;PP T1.5 W L G BLK CE745G	1	●	
D 7	DE01-00003B	FILM-DOOR;PC T0.2 W143 L265 TRP CE745G	1	●	

7-4 Control Parts List

Ref. No.	Parts No.	Description/Specification	Q'ty	Remarks	Old Parts No.
C 1	DE66-20006A	BUTTON-PUSH;RESIN-ABS(HR-0370U) P/WHT M9	1	●	76674-239-310
C 2	DE61-70076A	SPRING-BUTTON;HSWR PI0.6	1		
C 3	DE34-10007C	SWITCH-MEMBRANE;PET 230V50HZ W89.7 L161.	1	● ▲	
C 4	DE72-70003A	CONTROL-PANEL;ABS(VH-080) WHT	1	●	
C 5	DE67-40002A	WINDOW-DISPLAY;RESIN-ACRYLIC T2.3 M945(I	1	●	
C 6	DE91-10377A	ASSY P.C.B-MAIN;230V50HZ NS V.F.D CE945G	1	● ▲	

7-5 Body Latch Parts List

Ref. No.	Parts No.	Description/Specification	Q'ty	Remarks	Old Parts No.
B 1	DE66-40001A	LATCH-BODY;POM(F20-02) 40GR NTR	1	●	73579-203-207
B 2	3405-000178	SWITCH-MICRO;VP-533A-OF-PS(T85) 250V,15A	1		
B 3	3405-000175	SWITCH-MICRO;VP-531A-OF(T85) 250V,15A,20	1		
B 4	3405-000178	SWITCH-MICRO;VP-533A-OF-PS(T85) 250V,15A	1		
B 5	DE66-90001A	LEVER-SWITCH;P.O.M(F20-02) 2 6 NTR 2ND-W	1	●	

7-6 Standard Parts List

Parts No.	Description / Specification	Q'ty	Remarks	Old Parts No.
DE60-10012A	SCREW-TAP TITE;TH + 3 M4 L10 SWR10 ZPC2	1	NO-FIL	70504-0002-00
DE60-10012A	SCREW-TAP TITE;TH + 3 M4 L10 SWR10 ZPC2	1	P-CO-E	70504-0002-00
DE60-10012A	SCREW-TAP TITE;TH + 3 M4 L10 SWR10 ZPC2	2	HI-UPP	70504-0002-00
DE60-10122A	SCREW-TAP TH;TAP TH 2-4X8 FE FN	2	C-CEIL	77128-240-085
DE60-10122A	SCREW-TAP TH;TAP TH 2-4X8 FE FN	2	B/HEAT	77128-240-085
DE60-10098A	SCREW-ASSY TAPTITE;PH TC M4X8 SWRCH18A Z	2	MO/DRI	A0103-0010
DE60-10082I	SCREW-A;2S-4X12 FEFZY	4	OUT-PN	77154-203-8201
DE60-10082I	SCREW-A;2S-4X12 FEFZY	4	B-PLTE	77154-203-8201
DE60-10080A	SCREW-WASHER;M5 L12 2S	4	MGT	77154-202-910
DE60-10080A	SCREW-WASHER;M5 L12 2S	4	HVT	77154-202-910
DE60-10069A	SCREW-TAP TH;TH M4 L10 FRFZY	1	CV/AIR	77128-540-101
DE02-00029A	TAPE-SCOTCHPAR;POLYESTER 3M-893 W50	1	TR-CUS	70859-800-311
DE60-10069A	SCREW-TAP TH;TH M4 L10 FRFZY	3	B/UPP	77128-540-101
DE60-10012A	SCREW-TAP TITE;TH + 3 M4 L10 SWR10 ZPC2	2	HI-LOW	70504-0002-00
DE60-10098A	SCREW-ASSY TAPTITE;PH TC M4X8 SWRCH18A Z	1	MEM-PN	A0103-0010
DE60-10098A	SCREW-ASSY TAPTITE;PH TC M4X8 SWRCH18A Z	1	CV-TCO	A0103-0010
DE60-10082J	SCREW-TAPPING;TH 2S-4X8 MSWR3 ZPC YEL WS	1	B/HVC	77154-203-8401
DE60-10082I	SCREW-A;2S-4X12 FEFZY	2	BD-LAT	77154-203-8201
DE60-10082I	SCREW-A;2S-4X12 FEFZY	2	CON-PA	77154-203-8201
DE60-10012A	SCREW-TAP TITE;TH + 3 M4 L10 SWR10 ZPC2	1	C/GE-M	70504-0002-00
DE60-10098A	SCREW-ASSY TAPTITE;PH TC M4X8 SWRCH18A Z	2	MGT-TC	A0103-0010
DE60-10052A	SCREW-TAP PH;PH M4 L8 FEFZY	2	GR-TCO	77108-540-081
DE60-10018A	SCREW-ASSY MACHINE;PH M4X0.7P 8 MSWR10 S	2	B/EATH	70504-0019-00
DE60-10013A	SCREW-ASSY TAP;TH 2S 4 L12 MSWR3 ZPC3 FI	2	CV/BLW	70504-0004-00

8. P.C.B Diagrams

8-1 P.C.B Diagrams

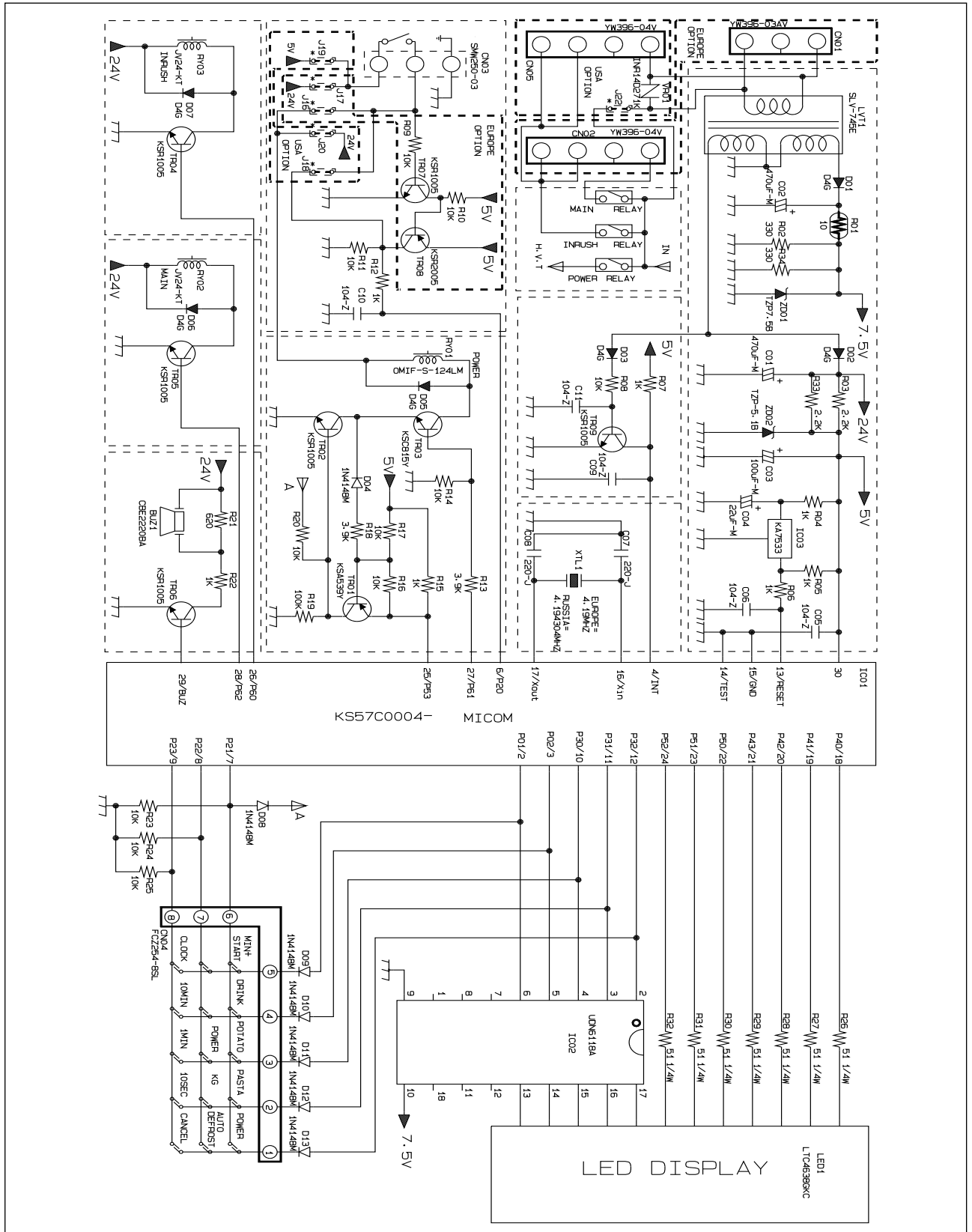

8-2 P.C.B Parts List

Parts No.	Description / Specification	Q'ty	Remarks
0401-001002	DIODE-SWITCHING;1N4148M,100V,200mA,500mW	16	D5-20
0402-000559	DIODE-RECTIFIER;D4G,400V,1A,T-1	3	D01,2,4
0501-000283	TR-SMALL SIGNAL;KSA539-Y,PNP,400mW,TO-92	1	TR01
0501-000388	TR-SMALL SIGNAL;KSC815-Y,NPN,400mW,TO-92	1	TR03
2001-000003	R-CARBON;330ohm,5%,1/8W,AA,TP,1.8x3.2mm	2	R03,04
2001-000037	R-CARBON(S);330ohm,5%,1/2W,AA,TP,2.4x6.4	1	R02
2001-000273	R-CARBON;100Kohm,5%,1/8W,AA,TP,1.8x3.2m	1	R12
2001-000290	R-CARBON;10Kohm,5%,1/8W,AA,TP,1.8x3.2mm	6	R9,10,14,15,16,43
2001-000429	R-CARBON;1Kohm,5%,1/8W,AA,TP,1.8x3.2mm	7	R05-08,17-19
2001-000613	R-CARBON;3.9Kohm,5%,1/8W,AA,TP,1.8x3.2m	1	R11,13,20,21,22,23,42
2001-000776	R-CARBON;470ohm,5%,1/2W,AA,TP,3.3x9mm	1	R01
2001-000786	R-CARBON;47Kohm,5%,1/8W,AA,TP,1.8x3.2mm	12	R30-41
2011-001043	R-NETWORK;47Kohm,5%,1/8W,A,SIP,8P,BK	1	AR01
2202-000780	C-CERAMIC,MLC-AXIAL;UP050F104Z 100NF,+80	6	C6,9,10,11,12,15
2401-000247	C-AL;1SA1ANB107MAN 100UF,20%,10V,GP 6.3X	1	C04
2401-000353	C-AL;1SA1HWB101M 100UF,20%,50V,GP 10X16X	1	C02
2401-000914	C-AL;CESSL1C220M0511AA 22UF,20%,16V,GP 5	1	C05
2401-001412	C-AL;1SG1VFB477MAN 470UF,20%,35V,GP 10X1	1	C01
3501-001014	RELAY-POWER;OM1F-S-124LM 24V,21.8MA,17A	1	RY01
3501-001015	RELAY-POWER;OZF-S-124LM1P 24V,21.8MA,16A	1	RY04
3501-001016	RELAY-MINIATURE;JV24-KT 24V,12.5MA,5A 1F	2	RY02,03
3708-000528	CONNECTOR-FPC/FC/PIC;FCZ254-13SL,BLK 13P	1	CN02
3711-000203	CONNECTOR-HEADER;YW396-03AV WHT STRAIGHT	1	CN01
3711-000881	CONNECTOR-HEADER;SMW250-03,WHT BOX,3P,1R	1	CN03
A1018-0067	R-NETWORK;RN 1/8 X 6P 473-J T MHR5A473J	1	AR02
A1100-1049	C-CERAMIC;CC OA CH 50V T 220-J 3.5X1.9 U	6	C7,8,16-19
A4060-0008	TR-W/RESISTOR;KSR1005 300MW 100MA 50V EB	5	TR2,4-8
A4060-0009	TR-W/RESISTOR;KSR2005 300MW -100MA -50V	1	TR09
A4106-0154	DIODE-ZENER;TZP5.1B 5.1/5.7V 40MA T 1W	3	ZD1,2,3
A6010-0461	CONNECTOR-WAFER;YW396-04V WHT	1	CN04
B1283-0030	RESONATOR-CERAMIC;4.19MHZ 4.19MSTAR 2/CN	1	X-TAL
DE07-10081A	V.F.DISPLAY;SVM-4SM03 GRN/RSHORG 4 51 81	1	VFD
DE09-30479A	IC-MCU;KS56C671-43 DIP CE945G/CE745G	1	IC01 
DE13-20009A	IC;KA7533 DIP	1	IC02 
DE26-20141A	TRANS-L.V;SLV-945E 230V 50HZ AC17/2.9V	1	LVT1
DE30-20016A	BUZZER;CBE2220BA STICK	1	BUZ1
DE39-60001A	WIRE-SO COPPER;PI0.6 SN T 52MM	26	J01-26
DE60-60012A	PIN-EYELET;ID2.1 OD2.5 L3.0 SN BSP T0.25	8	E1-8
DE61-90004A	HOLDER-DIGITRON;NYLON#66 1.5 85 36 8GR B	1	

9. Schematic Diagrams

9-1 Schematic Diagrams

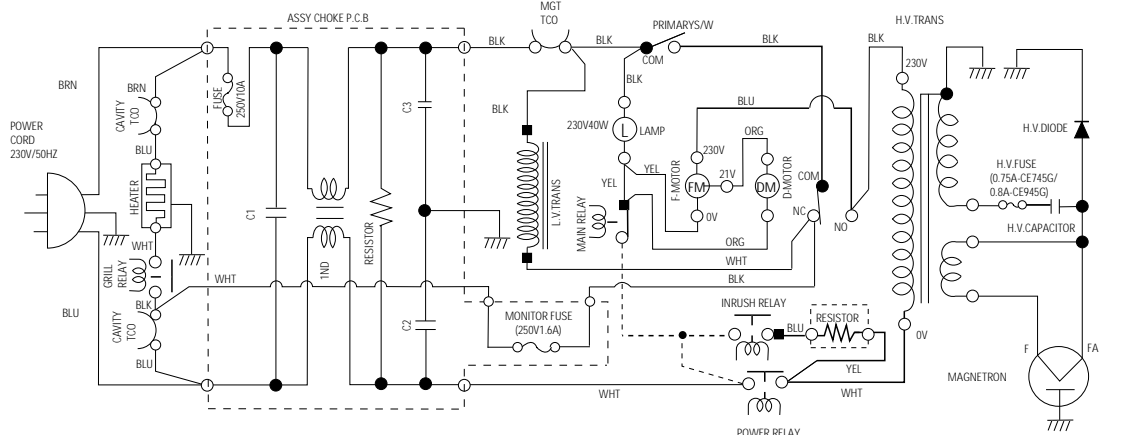

CONDITION OF OVEN

DOOR IS OPENED
COOK OFF

WIRING COLOR

BRN : BROWN BLU : BLUE
WHT : WHITE ORG : ORANGE
RED : RED YEL : YELLOW
BLK : BLACK
Y/G : YELLOW GREEN

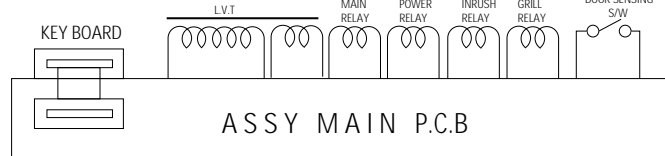

1. INPUT : 230V
2. DOOR : OPEN
3. LAMP : ON
4. --- : P.C.B PATTERN
5. ■ : P.C.B IN/OUT POINT

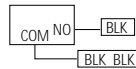

PRIMARY LATCH SWITCH

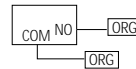

DOOR SENSING SWITCH

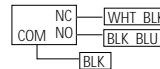

MONITOR SWITCH

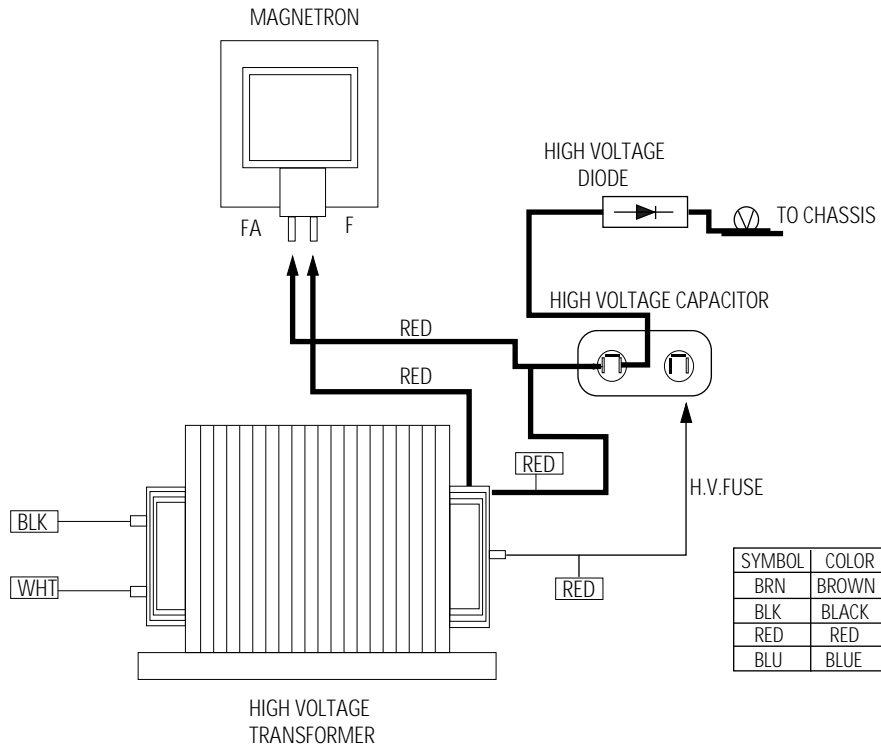

SYMBOL	COLOR
BRN	BROWN
BLK	BLACK
RED	RED
BLU	BLUE

Free Manuals Download Website

<http://myh66.com>

<http://usermanuals.us>

<http://www.somanuals.com>

<http://www.4manuals.cc>

<http://www.manual-lib.com>

<http://www.404manual.com>

<http://www.luxmanual.com>

<http://aubethermostatmanual.com>

Golf course search by state

<http://golfingnear.com>

Email search by domain

<http://emailbydomain.com>

Auto manuals search

<http://auto.somanuals.com>

TV manuals search

<http://tv.somanuals.com>