



Commercial Microwave Oven Owner's Manual

CM1029B (1000Watts)



Code No. : DE68-01223A-1

PRECAUTIONS TO AVOID POSSIBLE EXPOSURE TO EXCESSIVE MICROWAVE ENERGY:



- (a) Do not attempt to operate this oven with the door open since open-door operation can result in harmful exposure to microwave energy.
It is important not to defeat or tamper with the safety interlocks.
- (b) Do not place any object between the oven front face and the door or allow soil or cleaner residue to accumulate on sealing surfaces.
- (c) Do not operate the oven if it is damaged. It is particularly important that the oven door close properly and that there is no damage to the:
 - (1) Door (bent)
 - (2) Hinges and latches (broken or loosened)
 - (3) Door seals and sealing surfaces
- (d) The oven should not be adjusted or repaired by anyone except properly qualified service personnel.



WARRANTY AND SERVICE INFORMATION

To help us better serve you, please complete the enclosed registration card and promptly return it by mail. If the registration card is missing, you can call Samsung Electronics America, Inc., at 1-800-SAMSUNG (800-726-7864), or register on-line at WWW.SAMSUNGUSA.COM

When contacting Samsung, please provide the specific model and serial number information which is usually located on the back or bottom of the product. Please record these numbers below, along with the other requested information. Keep this information in a safe place as a permanent record of your purchase to aid in identification in case of theft or loss, and a copy of your sales receipt as a proof of purchase if warranty service is needed.

MODEL NUMBER _____

SERIAL NUMBER _____

DATE PURCHASED _____

PURCHASED FROM _____

Warranty service can only be performed by a Samsung Authorized Service Center. If you should require warranty service, provide the above information with a copy of your sales receipt to the Samsung Authorized Service Center. For service assistance and the location of the nearest service center, please call 1-800-SAMSUNG (800-726-7864), or go on-line to WWW.SAMSGUNSUPPORT.COM



Press



Important



Note

Thank You for Choosing Samsung

Thank you for choosing Samsung! Your new oven represents the very latest in microwave cooking technology. This oven is a full-featured, easy-to-use appliance built to strict quality standards set by Samsung — the highest in the industry. We're proud to offer you a product that will provide convenient, dependable service for years to come.

IMPORTANT SAFETY INSTRUCTIONS When Using Any Electrical Appliance

- When using any electrical appliance, basic safety precautions should be followed, including the following:



WARNING : To reduce the risk of burns, electric shock, fire, injury to persons or exposure to excessive microwave energy:

- Read all safety instructions before using the appliance.
- Read and follow the specific "PRECAUTIONS TO AVOID POSSIBLE EXPOSURE TO EXCESSIVE MICROWAVE ENERGY" inside the front cover of this manual.
- This appliance must be grounded. Connect only to properly grounded outlets. See "Grounding Instructions" on page 3.
- Install or locate this appliance only in accordance with the provided installation instructions.
- Some products, such as whole eggs and sealed containers, may explode and should not be heated in this oven.
- Use this appliance only for its intended use as described in the manual. Do not use corrosive chemicals or vapors in this appliance. This type of oven is specifically designed to heat, cook, or dry food. It is not designed for laboratory use.
- As with any appliance, close supervision is necessary when used by children.
- Do not operate this appliance if it has a damaged cord or plug, if it is not working properly, or if it has been damaged or dropped.
- This appliance should be serviced only by qualified service personnel. Contact the nearest authorized service facility for examination, repair, or adjustment.
- Do not cover or block any of the openings on the appliance.
- Do not store this appliance outdoors. Do not use this product near water – for example, near a kitchen sink, in a wet basement, or near a swimming pool, and the like.
- Keep the inside of oven clean. Food particles or spattered oils stuck to the oven walls or floor can cause reduce the efficiency of the oven.

SAVE THESE INSTRUCTIONS

When Using Any Electrical Appliance (cont.)

- Do not immerse cord or plug in water.
- Keep cord away from heated surfaces.
- Do not let cord hang over edge of table or counter.
- When cleaning door and oven surfaces, use only mild, non-abrasive soaps or detergents applied with a sponge or soft cloth.
- To reduce the risk of fire in the oven cavity:
 - a. Do not overcook food. Carefully attend appliance if paper, plastic, or other combustible materials are placed inside the oven to facilitate cooking.
 - b. Remove wire twist-ties from plastic cooking bags before placing bags in oven.
 - c. If materials inside the oven ignite, keep the oven door closed, turn the oven off, disconnect the power cord, or shut off the power at the fuse or circuit breaker panel.
 - d. Do not use the oven compartment for storage purposes. Do not leave paper products, cooking utensils, or food in the oven when not in use.
- Do not try to preheat oven or operate while empty.
- Do not cook without the plate tray in place on the oven floor as food will not cook properly.
- Do not cover the rear ventilation slots with cloths or paper.
- Dishes and containers can become hot. Handle with care.
- Carefully remove utensil coverings, directing steam away from hands and face.
- Do not defrost frozen beverages in narrow-necked bottles. The container may break.
- Remove lids from baby food before heating. After heating stir well and test temperature before serving to baby.

SAVE THESE INSTRUCTIONS

GROUNDING INSTRUCTIONS

This appliance must be grounded. In the event of an electrical short circuit, grounding reduces the risk of electric shock by providing an escape wire for the electric current. This appliance is equipped with a cord having a grounding wire with a grounding plug. The plug must be plugged into an outlet that is properly installed and grounded.



WARNING: Improper use of grounding can result in risk of electric shock. Consult a qualified electrician or serviceperson if the grounding instructions are not completely understood, or if doubt exists as to whether the appliance is properly grounded.

Use of Extension Cords

A short power-supply cord is provided to reduce the risks resulting from becoming entangled in or tripping over a longer cord.

Longer cord sets or extension cords are available and may be used if care is exercised in their use.

If a long cord or extension cord is used-

1. The marked electrical rating of the cord set or extension cord should be at least as great as the electrical rating of the appliance.
2. The extension cord must be a grounding-type 3-wire cord and it must be plugged into a 3-slot outlet.
3. The longer cord should be arranged so that it will not drape over the counter top or tabletop where it can be pulled on by children or tripped over unintentionally.

If you use an extension cord, the interior light may flicker and the blower may vary when the microwave oven is on. Cooking times may be longer, too.



WARNING: Do not cut or remove the third (ground) prong from the power cord under any circumstances.

Preferred method of grounding

Plug the three-prong power cord into a properly grounded outlet of standard AC 120 voltage, 60 Hz. Your oven should be the only appliance on this circuit.

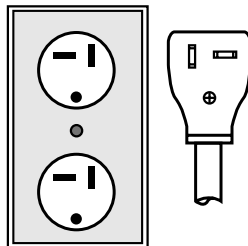

NEMA 5-20
125V-20AMP

SAVE THESE INSTRUCTIONS



*You have just purchased a
SAMSUNG microwave oven.*

*Your Owner's Instructions contain valuable
information on cooking with your
microwave oven. Take the time to read them
as they will help you take full advantage of
the microwave oven features.*

Contents

◆ Oven Features	
■ Oven	5
■ Control Panel	6
◆ Installing and Preparing Your Microwave Oven	
■ Placement of Your Microwave Oven	7
■ Cleaning Your Microwave Oven	8
■ Storing and Repairing Your Microwave Oven	8
■ Cookware Guide.....	9
◆ Cooking with Your Microwave Oven	
■ Cooking/Reheating	10
■ Power Levels and Time Variations	11
■ Repeat Feature	11
■ Using Start/30sec+ pad	12
■ Using the Defrost Feature	12
■ Memory Pads Programming.....	13
■ How to Operate Memory Cooking.....	14
■ Stopping the Cooking	14
■ Double Quantity Pad Programming	15
■ How to Operate Double Quantity Pad.....	16
■ Programming Air Filter Clean Time	17
■ Controlling Beep Tone	17
■ Error Codes	18
■ Before Calling for Service	18
■ Hidden Keys	19
◆ Recommendations for Use	
■ Care of Your Microwave Oven	20
■ Replacement of Lamp	21
■ Cooking Guide.....	22
■ Cooking Guide.....	23
■ Technical Specifications	24
◆ Warranty Info	Inside Back Cover

Oven

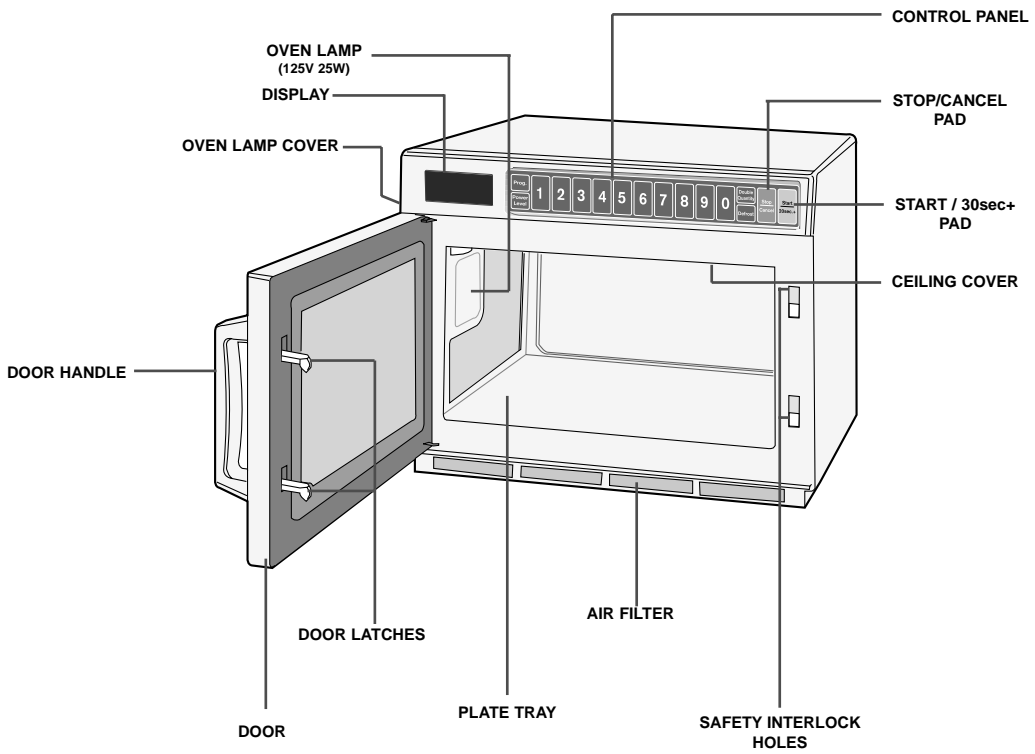

Control Panel

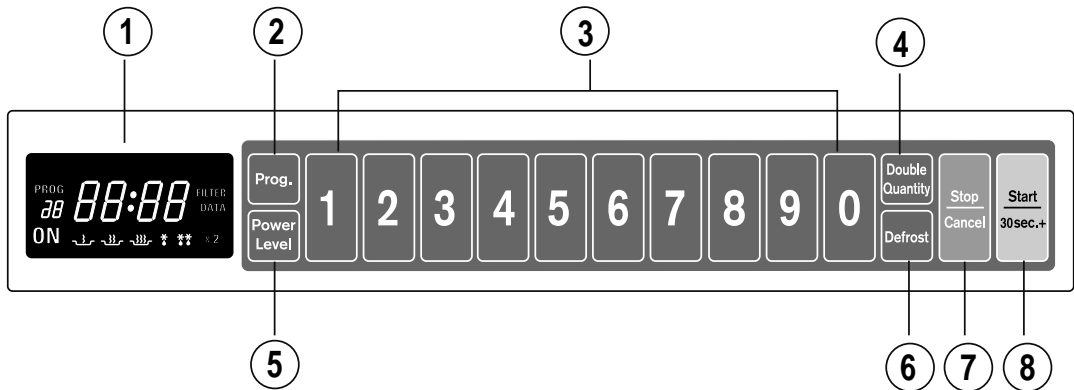

1. DISPLAY
2. PROGRAM PAD
3. NUMBER PADS(Time, Memory Programming)
4. DOUBLE QUANTITY PAD
5. POWER LEVEL SELECTOR PAD
6. DEFROST SELECTOR PAD
7. STOP/CANCEL PAD
8. START/30sec+ PAD (One Touch Cook Pad)

DISPLAY

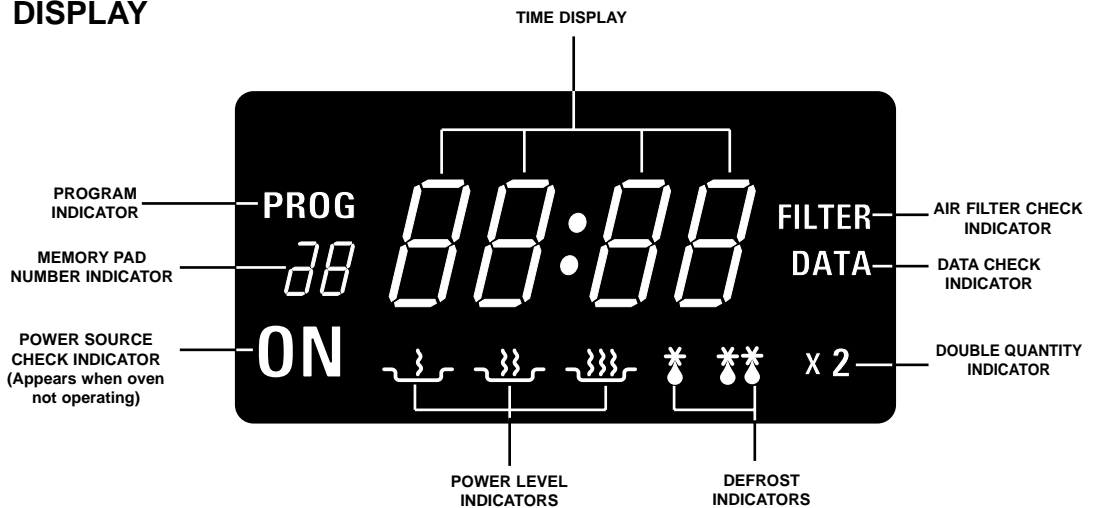

Placement of your Microwave Oven

This microwave oven can be placed almost anywhere (kitchen work surface or shelf, movable trolley, table).

- 1** Install the oven on a flat, level, stable surface. Make sure there is adequate ventilation for your oven by leaving at least 10cm(four inches) of space behind and on the sides of the oven and 20cm(eight inches) above. (For stacking see page 21.)
- 2** Never block the air vents as the oven may overheat and automatically switch itself off. It will remain inoperable until it has cooled sufficiently.
- 3** Remove all packing materials inside the oven.
- 4** Plug the cable into a 3-pin, grounded socket. If the power cable of this appliance is damaged, it must be replaced by a special cable as supplied from an authorized Samsung Service Center.



Be sure to remove the protective film from outer case. The protective film is on the outer case to prevent scratches. When installing or before using, be sure to remove it.

Outdoor Use

This microwave oven is not designed for outdoor use.

You should use it indoors only.

Cooling Fan

Do not unplug the oven during the first minute that the fan is operating.

Recommendations

DO NOT install the microwave oven in hot or damp surroundings.

Example: Next to a traditional oven or radiator.

The power supply specifications of the oven must be respected and any extension cable used must be of the same standard as the power cable supplied with the oven.

Wipe the interior and the door seal with a damp cloth before using your microwave oven for the first time.

Cleaning Your Microwave Oven

Recommendations

DO NOT spill water in the vents.

NEVER use any abrasive products or chemical solvents.

Take particular care when cleaning the door seals to ensure that no particles:

- ◆ Accumulate
- ◆ Prevent the door from closing correctly

The following parts of your microwave oven should be cleaned regularly to prevent grease and food particles from building up:

- ◆ *Inside and outside surfaces*
- ◆ *Door and door seals*
- ◆ *Plate tray*



ALWAYS ensure that the door seals are clean and the door closes properly.

- 1 Clean the outside surfaces with a soft cloth and warm, soapy water. Rinse and dry.
- 2 Remove any splashes or stains on the inside surfaces with a soapy cloth. Rinse and dry.
- 3 To loosen hardened food particles and remove smells, place a cup of diluted lemon juice on the plate tray and heat for three minutes at maximum power.

Storing and Repairing Your Microwave Oven

A few simple precautions should be taken when storing or having your microwave oven serviced.

The oven must not be used if the door or door seals are damaged:

- ◆ *Broken hinge*
- ◆ *Deteriorated seals*
- ◆ *Distorted or bent oven casing*

Only a qualified microwave service technician should perform repairs.



NEVER remove the outer casing from the oven. If the oven is faulty and needs servicing or you are in doubt about its condition:

- ◆ Unplug it from the wall socket
- ◆ Contact the nearest Samsung Authorized Service Center

Cookware Guide

To cook food in the microwave oven, the microwaves must be able to penetrate the food, without being reflected or absorbed by the dish used.

Care must therefore be taken when choosing the cookware. If the cookware is marked microwave-safe, you do not need to worry.

The following table lists various types of cookware and indicates whether and how they should be used in a microwave oven.

Cookware	Microwave-Safe	Comments
Aluminium foil	✓ X	Can be used in small quantities to protect areas against overcooking. Arcing can occur if the foil is too close to the oven wall or if too much foil is used.
Browning plate	✓	Do not preheat for more than three minutes.
China and earthenware	✓	Porcelain, pottery, glazed earthenware and bone china are usually suitable, unless decorated with a metal trim.
Disposable polyester cardboard dishes	✓	Some frozen foods are packaged in these dishes.
Fast-food packaging		
• Polystyrene cups and containers	✓	Can be used to warm food. Overheating may cause the polystyrene to melt.
• Paper bags or newspaper	X	May catch fire.
• Recycled paper or metal trims	X	May cause arcing.
Glassware		
• Oven-to-tableware	✓	Can be used, unless decorated with a metal trim.
• Fine glassware	✓	Can be used to warm foods or liquids. Delicate glass may break or crack if heated suddenly.
• Glass jars	✓	Must remove the lid. Suitable for warming only.
Metal		
• Dishes	X	May cause arcing or fire.
• Freezer bag twist ties	X	
Paper		
• Plates, cups, napkins and kitchen paper	✓	For short cooking times and warming. Also to absorb excess moisture.
• Recycled paper	X	May cause arcing.
Plastic		
• Containers	✓	Particularly if heat-resistant thermoplastic. Some other plastics may warp or discolour at high temperatures. Do not use Melamine plastic.
• Cling film	✓	Can be used to retain moisture. Should not touch the food. Take care when removing the film as hot steam will escape.
• Freezer bags	✓ X	Only if boilable or oven-proof. Should not be airtight. Prick with a fork, if necessary.
Wax or grease-proof paper	✓	Can be used to retain moisture and prevent spattering.

✓ = recommended ✓ X = use caution X = unsafe

Cooking/Reheating

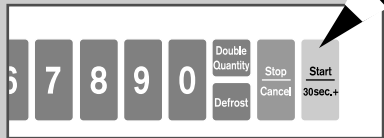
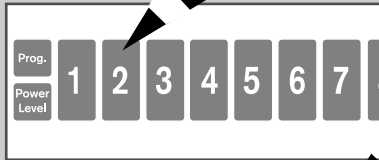
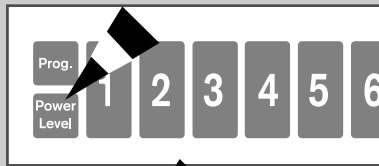

- When you first plug in the power cord, the oven beeps once and all the indicators are displayed in the display window for 5 sec.
- When heating cycle is completed and you open the door, the oven lamp and the cooling fan automatically turn on and goes off 1 min later.
- When you open the door during a heating cycle, the oven stops operating and the oven lamp as well as the cooling fan automatically turns on for 1 min and goes off 1 min later. If you leave the oven door open for more than 1 min, the oven beeps once every minute and after 5 min the power source check indicator 'ON' appears in the display window.

This oven is preset at the factory for automatic operation.

- 1 Make sure the oven is plugged into a properly grounded electrical outlet and "ON" appears in the display window.

- 2 Open the door.
The oven lamp will be turned on.



- 3 Put the food into a suitable container, place it in the centre of the oven and then close the door securely.

Result: The oven lamp will go off.

- 4 Select the desired power level by pressing the Power Level Selector pad.

Result: The selected power level will be displayed in the display window.



- 5 Set the desired heating time by pressing the Number pads.

Result: The selected time is displayed in the display window.



- 6 Press Start pad:

Result: The oven lamp and cooling fan will be turned on.
Heating will start.
The time on digital display will count down.

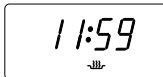

- 7 When all time has elapsed, the end of cycle Beep Tone will sound 4 times and all heating will stop. The oven lamp will go off. For 1 min, the display shows '0' and the cooling fan will keep working in order to cool down the interior parts. During the time, the fan will not stop even when you open the door. 1 min later it will stop and "ON" appears again. Food may be removed from oven while the fan is still running.







- 8 Open the door and take the food out.

- 9 Close the door. The oven lamp will go off.





➤ While in a heating cycle, one press on Stop/Cancel pad stops the oven. At this time, the Power Check Indicator "ON" starts blinking and goes off when the Stop/Cancel pad or Start pad is pressed again. You can restart it by pressing the Start pad or a second press on Stop/Cancel pad will cancel the selected program. While NOT in a heating cycle, one tap on Stop/Cancel pad cancels the selected program. You can press Start/30sec.+ pad one or more times in order to add the cooking time by 30 seconds. But you can not exceed the maximum time per power level allowed for power level selected.

Power Levels and Time Variations

The power level function enables you to adapt the amount of energy dissipated and thus the time required to cook or reheat your food, according to its type and quantity. You can choose between the power levels below.

Power Level	Percentage	Output
HIGH()	100%	1000 W
MEDIUM()	70%	700 W
LOW()	50%	500 W
HIGH DEFROST()	30%	300 W
LOW DEFROST()	18%	180 W

The cooking times given in recipes and in this booklet correspond to the specific power level indicated.

Power Level	Max. Time
HIGH()	25 min.
MEDIUM()	40 min.
LOW()	40 min.
HIGH DEFROST()	50 min.
LOW DEFROST()	50 min.

Power levels may be changed during the cooking/reheating cycle by pressing the power level pad or defrost selector pad. The oven doesn't need to be stopped to do this.

Repeat Feature

- 1 You can repeat the previous cooking setting (regardless of manual or automatic memory heating) by pressing the START pad. The oven starts with exactly the same heating time and power level that were used in the last operation.
 - Repeat feature is available for display show "0".
(You can use repeat feature for 1 hr only after latest operation.)
- 2 The repeat feature will be cancelled once the power source is cut off.

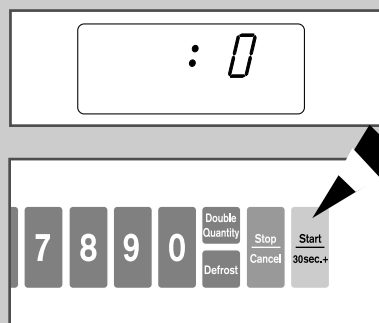

Using Start/30sec.+ Pad

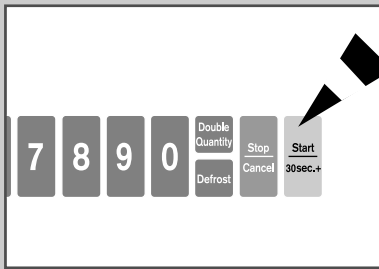

This is a ONE TOUCH COOK pad.

By touching the pad once, you can start heating instantly.

You can increase the cooking time by pressing the Start/30sec.+ pad while heating is being done.

A cooking time can be increased by 30 seconds by pressing the Start/30sec.+ pad. But it can not exceed the maximum time.

Like traditional cooking, you may find that, depending on the food's characteristics or your tastes, you have to adjust the cooking times slightly. You can:

- ◆ Check how cooking is progressing at any time simply by opening the door
- ◆ Close the door
- ◆ Increase the remaining cooking time

Before operating the oven, times can be increased/decreased using either the time pads or Start/30sec.+ pad. During operation, time may only be added by using the Start/30sec.+ pad.

Using the Defrost Feature

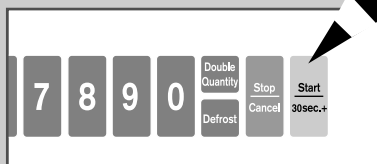
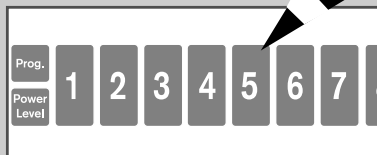
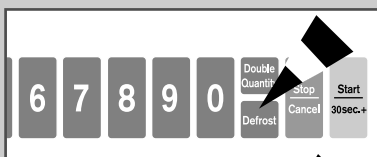

➤ When the oven operates for longer than 25 min under Defrosting cycle, you can NOT change the power level from Defrosting to Heating (Cooking/Reheating) mode.



The Defrost feature enables you to defrost meat, poultry or fish.



Use only containers that are microwave-safe.

- 1 Open the door.
- 2 Place the frozen food in the center of the plate tray.
- 3 Close the door.
- 4 Press the Defrost selector pad to set DEFROST HIGH () or DEFROST LOW () as you wish.
Result: The selected DEFROST indicator appears in the display.

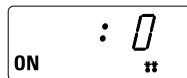

- 5 Press the Number pads to set the defrosting time. (Max. 50 min)



- 6 Press Start pad.
Result: Defrosting begins.

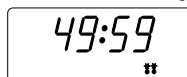

➤ It is not possible to set a defrosting time for longer than 50min. The defrost indicator will flash and it is advisable to press Stop/Cancel and enter a new defrost level and time.

Memory Pads Programming

- 1 Press PROGRAM pad(hold for more than 2 seconds).

Result: PROG indicator appears in the digital display.

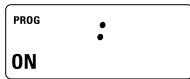

- 2 Press appropriate NUMBER pad for the desired memory number.
Result: Selected memory program code appears below the PROGRAM indicator.

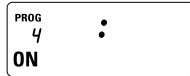

- 3 Select power level by pressing the POWER LEVEL or DEFROST pad.
Result: Default power level HIGH appears in the display at first press of the POWER LEVEL pad.

➤ Press the POWER LEVEL or DEFROST pad one or more times until you get the desired power level.

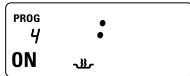

- 4 Press NUMBER pads to set the cooking time.
➤ The maximum time according to each cooking power level can be referred to in the title "Power Levels and Time Variations" on page 11. The NUMBER pads will not operate or respond when you press a cooking time exceeding the maximum value.
It is not possible to set a cooking time for longer than the maximum time allowed on the chosen program. The power level indicator will flash and it is advisable to press Stop/Cancel and to enter a new power level and cooking time.

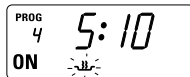

- 5 Press PROGRAM pad(hold for more than 2 seconds)
Result: PROG indicator and memory number indicator blink 3 times in the digital display with a beep sound. And then the display goes blank.
Caution: Be sure to press the pads firmly in the right position.



- 6 When you want to program more, repeat the procedures above again.
➤ Memory programs are available for up to 20 items. Make sure the unit is properly programmed.
After programming is finished, all you have to do for memory cooking is to press the NUMBER pad. Then the selected memory program automatically starts cooking.

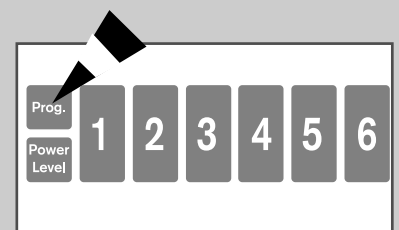
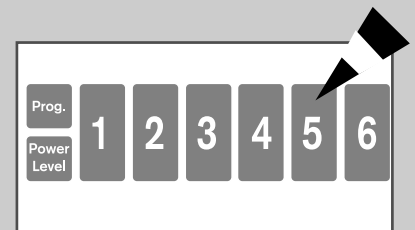
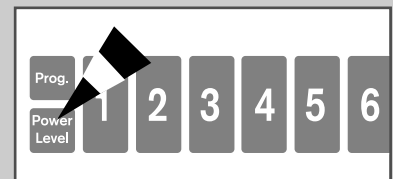
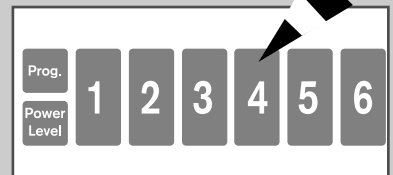
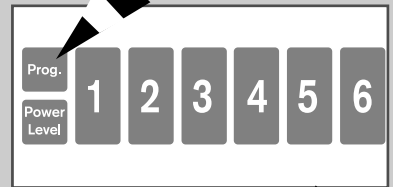

How to Operate Memory Cooking

After having finished memory programming, just press the NUMBER pad of the memory number you want to select. The oven will automatically start heating according to the pre-programmed cooking time and power level.

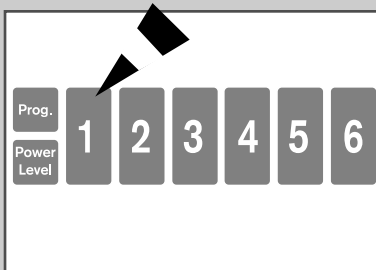

1 Make sure the oven is plugged into a properly grounded electrical outlet and "ON" appears in the display window.

2 Open the door.
The oven lamp will be turned on.



3 Put the food into a suitable container, place it in the centre of the oven and then close the door securely.
Result: The oven lamp will go off.

4 Press NUMBER pad.
Result: After 2 seconds, the selected memory program automatically starts heating.

Stopping the Cooking

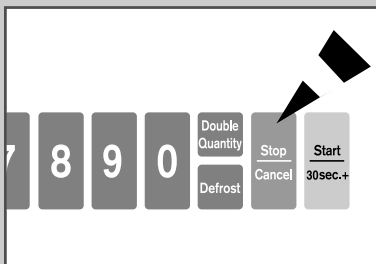

You can stop cooking at any time so that you can:

- ◆ *Check the food*
- ◆ *Turn the food over or stir it*
- ◆ *Leave it to stand*

To stop the cooking...

Then...

Temporarily

- ◆ Open the door or press Stop/Cancel pad once.

Result: Cooking stops.

To resume cooking, close the door and press Start again.

Completely

Press the Stop/Cancel pad twice.

Result: The cooking settings are cancelled.

If you want to cancel any cooking settings before starting cooking, simply press Stop/Cancel once.

Double Quantity Pad Programming

- 1 Hold down Stop/Cancel and then press DOUBLE QUANTITY pad. Hold together for 2 seconds.
- 2 Select desired program code by using NUMBER pads.
- 3 Press NUMBER pads to set the magnification factor within the range from 1.00 to 9.99.
 - Default factor is 1.65 preset from the manufacturer for increasing the cooking time.
 - Make sure that you set a correct factor between 1.00 and 9.99 for each memory code number.
- 4 Press Start pad.
- 5 Press Stop/Cancel pad to exit the programming mode.
 - Though you can successfully set a double quantity factor whose setting might result in excess of the maximum time allowed for each power level, the oven does not operate exceeding the maximum time.

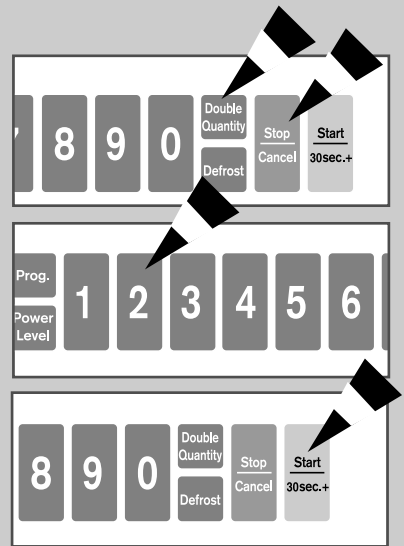

Double Quantity Factor Editing

Feature	Key Entry	Display	Remark
Double Quantity Factor Edit	1 Hold down Stop/Cancel and then Double Quantity pad.		Hold down for 2 sec.
	2 Select desired memory number		If you press pad 1, default value shows in the display window after 1sec.
	3 Input desired factor value by pressing NUMBER pad.		1.00 ~ 9.99 available (Change the factor if required.)
	4 Start/20sec.+		Reach completion
	If you want to continue to edit new memory number, follow the above procedures (2~4)		
5 Stop/Cancel		(Mode cancel)	This exits the editing mode.

How to Operate Double Quantity Pad

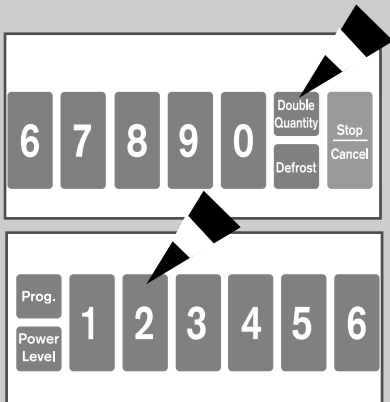

1 Press the Double Quantity pad.

2 Press the desired memory number pad.

Result: Cooking time which was multiplied by the preset factor appears in the display and cooking starts with time digits counting down.

➤ You don't need to press Start pad to start heating.

Programming Air Filter Clean Time

When the air filter check indicator (FILTER) appears in the display window after a certain time of use, you should clean the air filter according to the instructions "Cleaning the Air Filter" on page 20 in this booklet. Then follow the procedure as below if you want to change the air filter clean time.

- 1 Hold down Stop/Cancel and then press NUMBER 3 pad.
Result: The display will show the length of time in hours between cleaning the air filter you have programmed in or the original time preset by the manufacturer.
ex: 500 hours.
- 2 Press NUMBER pads to set the desired clean time.
➤ You can set up to 999 hours.
- 3 Press Stop/Cancel pad in order to save the new value.
This completes the programming of the air filter clean time.
- 4 Press Stop/Cancel pad to return to cooking mode.
➤ After the clean time has expired, you should clean the air filter. See page 20.

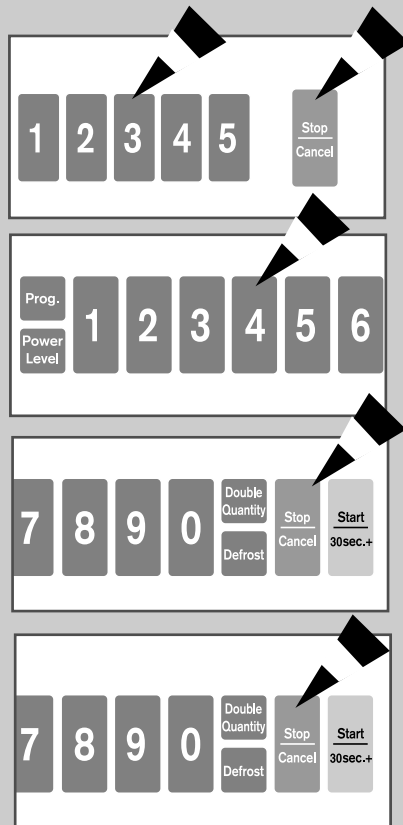

Controlling Beep Tone

You can select the beep tone you require. There are 4 sound levels available.

- 1 Hold down Stop/Cancel and then press NUMBER 0 pad. Hold together for 2 seconds.
Result: Beep tone is changed to one level higher than current one.
➤ Beep tone 0 does not make beep sound.

Settings are circulating whenever you press the hidden keys in the following order.
Snd 0 → Snd 1 → Snd 2 → Snd 3 → Snd 0 (No sound)
➤ Default tone is Snd 2.

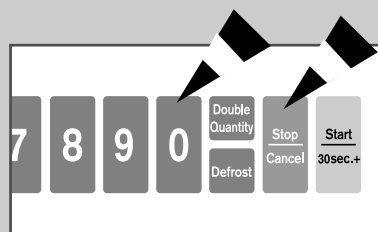

Error Codes

Error Items	Code	Error Beep	Cause/Remedy
Power frequency Error(50/60Hz)	E1	One long beep for 2 sec	<p><u>Cause:</u> Power frequency is other than 60 Hz.</p> <p><u>Remedy:</u></p> <ul style="list-style-type: none"> • Unplug the power cord plug and check if the power frequency is 60 Hz. • Plug the power cord in 60 Hz power source and see if "E1" appears. If the error code is displayed again even after the correct power source is provided, contact the nearest service center.
EEPROM Error	E5	One long beep for 2 sec	<p><u>Cause:</u> Memory IC (EEPROM IC) is not working correctly. In this case, other features except for memory function work properly. (You can operate the oven manually)</p> <p><u>Remedy:</u> Press CANCEL pad one or more times and try to start a memory function program. If the error code "E5" persists, contact your nearest service center.</p>

Before Calling for Service

Warning

To avoid electrical shock which can cause severe personal injury, do not remove outer case at any time.

Only authorized servicer should remove outer case.

If oven does not operate:

- Confirm oven is plugged into dedicated circuit.
- Confirm oven is on grounded and polarized circuit.
(Contact electrician to confirm)
- Check fuse or circuit breaker.

If oven light does not work:

- Confirm light bulb is screwed in tightly.
- Confirm light bulb is not defective.

If oven operates intermittently:

- Check inlet and discharge areas for obstructions.

If oven does not accept entries when pad is pressed:











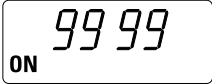

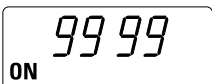
- Open and close oven door. Press pad again.

If oven malfunctions:

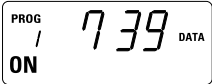
- Unplug oven, wait for 1 minute, and plug in oven.

Hidden Keys

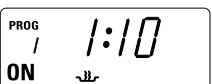
Note: Press Key 1 and then the next one. Hold for 2 secs.

Definiens	Key Entry		Display	Remark
	Key 1	Next		
Total power source supply time		1		Unit: 10 hrs. (ex: 99,990 time)
Total used time		2		Unit: 1 hr. (ex: 9,999 time)
Number of times of use by memory program code				Hold together for 2 sec.
	Program Code.			
	(Data display after 2 sec.)			739 times of use
	(New code can be set after data display)			
			(Mode Cancel)	
Heating time per memory program code (Automatic sequential display)				
			(Sequentially displays for 3 sec from 1 to 30)	
			(Mode Cancel)	

Care of Your Microwave Oven

Cleaning the Microwave Oven

- 1 Unplug the oven from the electrical socket before cleaning.
- 2 Clean the inside of the oven. Wipe up all spills with a damp cloth. Kitchen detergent solution may be used if the oven gets too dirty. Do not use harsh detergents or abrasives.
 - If food particles or spilled liquids stick to the oven walls, or between door seal and door surface, they will absorb microwaves possibly resulting in arcing or sparks.
- 3 Clean the outside of the oven with soap and water, then dry with a soft cloth.
Caution: Make sure that water does not get into the back ventilation or control panel opening.
- 4 When you clean the window of the door, be sure to use a soft cloth after washing with very mild soap and water. Do not use window cleaner as the front door can be scratched by harsh soap or cleaners.

Cleaning the Ceiling Cover

- 1 Hold side stoppers of ceiling cover with both hands and pull them in and down. Then take the ceiling cover out of the oven cavity.
- 2 Rinse ceiling cover in soapy water or Food Sanitizer Solution.
- 3 Be sure to replace the ceiling cover before using the oven.

CAUTION Ceiling cover must be in place securely when you use the oven.

When you removed the Ceiling Cover for the purpose of cleaning, be sure to be extremely careful about the exposed inside components on the top of the oven cavity. If any of them are deformed, abnormal symptoms can happen such as arcing or sparks during operation. In case of such problems, contact the nearest Samsung Authorized Service Center.

Cleaning the Air Filter

Clean the Air Filter regularly according to the following instructions. The oven may have problems when the Air Filter becomes clogged with dust.

- 1 Remove the bolt at both ends of the Air Filter.
- 2 Lift the Air Filter off the post carefully.
- 3 Wash this filter in warm soapy water.
- 4 Be sure to replace the Air Filter before using the oven.
 - If the Air Filter becomes clogged with debris, this will cause an overheating problem in the oven.
 - If the want to change the air filter clean time, refer to "Programming Air Filter Clean Time" in page 17.

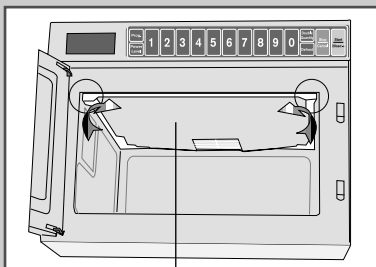

Ceiling Cover

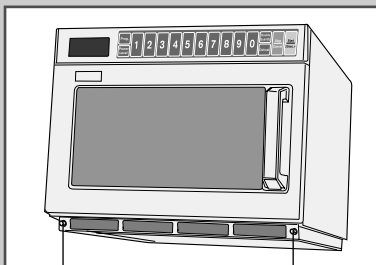

Bolt

Replacement of Lamp

Important

- 1 Remove the screw securing the lamp cover.
 - You don't need to remove outer panel to replace lamp.
- 2 Remove the lamp by rotating it counter-clockwise.
- 3 Replace with a new lamp by rotating it clockwise.

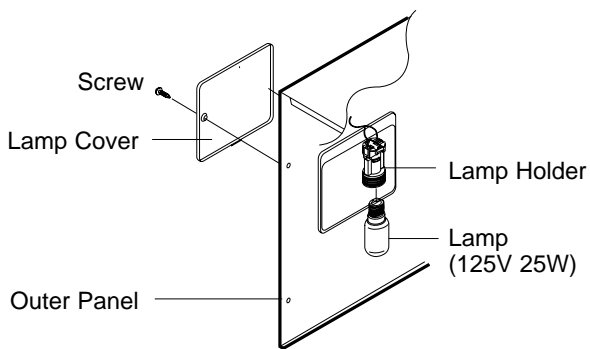

Cooking Guide

Food	Weight	Start Temp.	Method	Power Level	Time
To Cook					
Popcorn					
Regular	3.5 oz.	Room	Center bag on plate tray	High	2'25"
Light	3.0 oz.	Room	Center bag on plate tray	High	2'25"
Fresh Vegetables					
Corn on cob	1 ea	Room	Wrap in plastic wrap	High	1'55"
Corn on cob	2 ea	Room	Wrap in plastic wrap	High	3'50"
Corn on cob	4 ea	Room	Wrap in plastic wrap	High	7'00"
Cut-up Broccoli	8 oz.	Room	Add no water-cover	High	2'10"
Green Beans	8 oz.	Room	2 Tbsp. water-cover	High	2'40"
Green Beans	32 oz.	Room	2 Tbsp. water-cover	High	6'05"
Sliced Carrots	8 oz.	Room	2 Tbsp. water-cover	High	2'35"
Sliced Carrots	16 oz.	Room	2 Tbsp. water-cover	High	3'45"
Cauliflower Florets	8 oz.	Room	2 Tbsp. water-cover	High	2'10"
Cauliflower-Whole	1 lb. 4 oz.	Room	2 Tbsp. water-cover	High	7'10"
Potato- 1	8 oz.	Room	Prick-turn over 1/2 time	High	3'30"
Potatoes - 2	15 3/4 oz.	Room	Prick-turn over 1/2 time	High	5'50"
Potatoes - 4	30 oz.	Room	Prick-turn over 1/2 time	High	13'40"
Bacon					
Bacon	2 slices	Chilled	Cook between paper towels	High	1'20"
Bacon	4 slices	Chilled	Cook between paper towels	High	3'05"
Bacon	6 slices	Chilled	Cook between paper towels	High	4'00"
Hotdogs					
Hotdog - 1	2 oz.	Chilled	Add bun last 10"cook time	Med.- 70%	1'20"
Hotdogs - 2	4 oz.	Chilled	Add bun last 10"cook time	Med.- 70%	2'00"
Hotdogs - 4	8 oz.	Chilled	Add buns last 20"cook time	Med.- 70%	3'20"
Frozen Vegetables					
Frozen Vegetables	8 oz.	Frozen	Add 2 Tbsp. water, cover	High	2'10"
Frozen Vegetables	16 oz.	Frozen	Add 2 Tbsp. water, cover	High	4'00"
Frozen Vegetables	32 oz.	Frozen	Add 2 Tbsp. water, cover	High	7'00"
TO REHEAT:					
Hamburgers					
Hamburger - 1	4 oz.	Chilled	Add bun last 10" cook time	Med. - 70%	1'00"
Hamburgers - 2	8 oz.	Chilled	Add bun last 10" cook time	Med. - 70%	1'55"
Hamburgers - 4	16 oz.	Chilled	Add buns last 20"cook time	Med. - 70%	3'20"

Cooking Guide

To cook:	Weight	Start Temp.	Method	Power Level	Time
Pizza					
1 slice	4 oz.	Chilled	Place on paper towel	Med. - 70%	50"
2 slices	8 1/4 oz.	Chilled	Place on paper towel	Med. - 70%	2'05"
4 slices	15 oz.	Chilled	Place on paper towel	Med. - 70%	3'20"
Fruit Pie					
1 slice	5 1/2 oz.	Chilled	Place on plate- no cover	100%	55"
2 slices	10 oz.	Chilled	Place on plate- no cover	100%	1'45"
4 slices	24 oz.	Chilled	Place on plate- no cover	100%	3'15"
Muffins					
1 muffin	2 3/4 oz.	Room	Place on paper towel	100%	10"
2 muffins	5 oz.	Room	Place on paper towel	100%	18"
4 muffins	11 oz.	Room	Place on paper towel	100%	32"
Dinner Plate					
Dinner Plate	Small*	Chilled	Cover with wax paper	Med. - 70%	4'20"
Dinner Plate	Large*	Chilled	Cover with wax paper	Med. - 70%	4'50"
Casserole					
Macaroni & Cheese	8 oz.	Chilled	Cover; stir halfway	Med. - 70%	3'15"
Macaroni & Cheese	16 oz.	Chilled	Cover; stir halfway	Med. - 70%	5'45"
Spaghetti & Meatballs	32 oz.	Chilled	Cover; stir halfway	Med. - 70%	9'00"

* Small dinner has 3-6 oz. meat, 1/2 cup potatoes, 1/2 cup vegetable"

* Large dinner has 7-10 oz. meat, 2/3 cup potatoes/starch, 2/3 cup vegetable"

Technical Specifications

SAMSUNG strives continually to improve its products. Both the design specifications and these user instructions are thus subject to change without notice.

Model	CM1029B
Power source	120 VAC , 60 Hz
Oven Cavity	0.9 cu.ft
Power consumption Microwave	1, 800 W
Output power	1, 000 W (IEC-705)
Operating frequency	2, 450 MHz
Dimensions (W x H x D) Outside	18 ⁹ / ₃₂ " (W) X 14 ⁷ / ₈ " (H) X 20 ¹⁵ / ₃₂ " (D)
Oven cavity	14 ⁹ / ₁₆ " (W) X 7 ¹⁵ / ₃₂ " (H) X 14 ⁹ / ₁₆ " (D)
Net Weight	58.4 lbs
Gross Weight	63.9 lbs

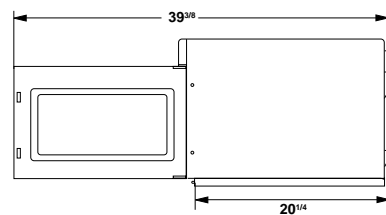
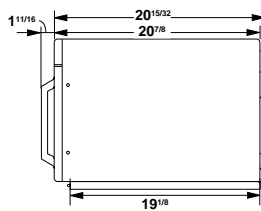
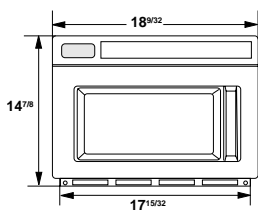

Memo

SAMSUNG LIGHT-DUTY COMMERCIAL MICROWAVE OVEN (1000 WATT) LIMITED WARRANTY TO ORIGINAL PURCHASER

This SAMSUNG brand product, as supplied and distributed by SAMSUNG ELECTRONICS AMERICA, INC. (SAMSUNG) and delivered new, in the original carton to the original consumer purchaser, is warranted by SAMSUNG against manufacturing defects in materials and workmanship for a limited warranty period of:

One (1) Year Parts and Labor

This limited warranty begins on the original date of purchase, and is valid only on products purchased and used in the United States. To receive warranty service, the purchaser must contact SAMSUNG for problem determination and service procedures. Warranty service can only be performed by a SAMSUNG authorized service center. The original dated bill of sale must be presented upon request as proof of purchase to SAMSUNG or SAMSUNG's authorized service center.

SAMSUNG will repair or replace this product, at our option and at no charge as stipulated herein, with new or reconditioned parts or products if found to be defective during the limited warranty period specified above. All replaced parts and products become the property of SAMSUNG and must be returned to SAMSUNG. Replacement parts and products assume the remaining original warranty, or ninety (90) days, whichever is longer.

On-site Service: During the one (1) year warranty labor period, on-site service will be provided subject to availability within the contiguous United States. On-site service is not available in all areas. To receive service, the product must be unobstructed and accessible to service personnel. If during on-site service repair can not be completed, it may be necessary to remove, repair and return the product. If on-site service is unavailable, SAMSUNG may elect, at our option, to provide for transportation of our choice to and from a SAMSUNG authorized service center. Otherwise, transportation to and from the SAMSUNG authorized service center is the responsibility of the purchaser.

This limited warranty covers manufacturing defects in materials and workmanship encountered in normal commercial use of this product and shall not apply to the following, including, but not limited to: damage which occurs in shipment; delivery and installation; applications and uses for which this product was not intended; altered product or serial numbers; cosmetic damage or interior and exterior finish; accidents, abuse, neglect, fire, water, lightning or other acts of nature; use of products, equipment, systems, utilities, services, parts, supplies, accessories, applications, installations, repairs, external wiring or connectors not supplied or authorized by SAMSUNG which damage this product or result in service problems; incorrect electrical line voltage, fluctuations and surges; customer adjustments and failure to follow operating instructions, cleaning, maintenance and environmental instructions that are covered and prescribed in the instruction book; problems caused by pest infestations, and overheating or overcooking by user; glass turntable or ceramic tray; consumables, such as light bulbs; reduced magnetron power output related to normal aging. SAMSUNG does not warrant uninterrupted or error-free operation of the product.

THERE ARE NO EXPRESS WARRANTIES OTHER THAN THOSE LISTED AND DESCRIBED ABOVE, AND NO WARRANTIES WHETHER EXPRESS OR IMPLIED, INCLUDING, BUT NOT LIMITED TO, ANY IMPLIED WARRANTIES OF MERCHANTABILITY OR FITNESS FOR A PARTICULAR PURPOSE, SHALL APPLY AFTER THE EXPRESS WARRANTY PERIODS STATED ABOVE, AND NO OTHER EXPRESS WARRANTY OR GUARANTY GIVEN BY ANY PERSON, FIRM OR CORPORATION WITH RESPECT TO THIS PRODUCT SHALL BE BINDING ON SAMSUNG. SAMSUNG SHALL NOT BE LIABLE FOR LOSS OF REVENUE OR PROFITS, FAILURE TO REALIZE SAVINGS OR OTHER BENEFITS, OR ANY OTHER SPECIAL, INCIDENTAL OR CONSEQUENTIAL DAMAGES CAUSED BY THE USE, MISUSE OR INABILITY TO USE THIS PRODUCT, REGARDLESS OF THE LEGAL THEORY ON WHICH THE CLAIM IS BASED, AND EVEN IF SAMSUNG HAS BEEN ADVISED OF THE POSSIBILITY OF SUCH DAMAGES. NOR SHALL RECOVERY OF ANY KIND AGAINST SAMSUNG BE GREATER IN AMOUNT THAN THE PURCHASE PRICE OF THE PRODUCT SOLD BY SAMSUNG AND CAUSING THE ALLEGED DAMAGE. WITHOUT LIMITING THE FOREGOING, PURCHASER ASSUMES ALL RISK AND LIABILITY FOR LOSS, DAMAGE OR INJURY TO PURCHASER AND PURCHASER'S PROPERTY AND TO OTHERS AND THEIR PROPERTY ARISING OUT OF THE USE, MISUSE OR INABILITY TO USE THIS PRODUCT SOLD BY SAMSUNG NOT CAUSED DIRECTLY BY THE NEGLIGENCE OF SAMSUNG. THIS LIMITED WARRANTY SHALL NOT EXTEND TO ANYONE OTHER THAN THE ORIGINAL PURCHASER OF THIS PRODUCT, IS NONTRANSFERABLE AND STATES YOUR EXCLUSIVE REMEDY.

Some states do not allow limitations on how long an implied warranty lasts, or the exclusion or limitation of incidental or consequential damages, so the above limitations or exclusions may not apply to you. This warranty gives you specific legal rights, and you may also have other rights which vary from state to state.

To obtain warranty service, please contact: **SAMSUNG ELECTRONICS AMERICA, INC. - WWW.SAMSUNGUSA.COM**

**SAMSUNG CUSTOMER SERVICE
1 SAMSUNG PLACE, LEDGEWOOD, NJ 07852
Tel: 973-691-6200, Fax: 973-691-6201
1-800-SAMSUNG (1-800-726-7864)
WWW.SAMSGUNSUPPORT.COM**

Warranty Info

Please complete the enclosed registration card and promptly return it by mail. If the registration card is missing, call Samsung Electronics at 1-800-SAMSUNG (1-800-726-7864) within the USA.

When contacting Samsung Electronics, please provide the product information, which is located on the serial tag usually found at the rear of the unit. Please keep a copy of the sales receipt for future reference or in case warranty service is required.

Warranty service can only be performed by an Authorized Samsung Service Center. To locate a Service Center in your area, please call Samsung Electronics at 1-800-SAMSUNG (1-800-726-7864) within the USA.



Printed in Korea

Free Manuals Download Website

<http://myh66.com>

<http://usermanuals.us>

<http://www.somanuals.com>

<http://www.4manuals.cc>

<http://www.manual-lib.com>

<http://www.404manual.com>

<http://www.luxmanual.com>

<http://aubethermostatmanual.com>

Golf course search by state

<http://golfingnear.com>

Email search by domain

<http://emailbydomain.com>

Auto manuals search

<http://auto.somanuals.com>

TV manuals search

<http://tv.somanuals.com>