

**SAMSUNG**

# MICROWAVE OVEN

**(COMMERCIAL)**

## Owner's Instructions and Cooking Guide

**CM1919 (1850 Watt)**

**CM1619 (1600 Watt)**

**CM1319 (1300 Watt)**



Oven .....	2
Using this Instruction Booklet.....	2
Safety Precautions .....	3
Installing Your Microwave Oven.....	4
Cooking / Reheating.....	5
Power Levels and Time Variations.....	6
Stopping the Cooking.....	6
Using +20sec Pad .....	6
Adjusting the Cooking Time .....	7
Using the Defrost Feature .....	7
Error Codes .....	8
Care of Your Microwave Oven.....	9
Installation Instructions for Stacking.....	10
Replacement of Lamp .....	10
Cookware Guide.....	11
Cooking Guide.....	12
Cleaning Your Microwave Oven.....	14
Storing and Repairing Your Microwave Oven.....	15
Technical Specifications.....	15

# Oven

GB

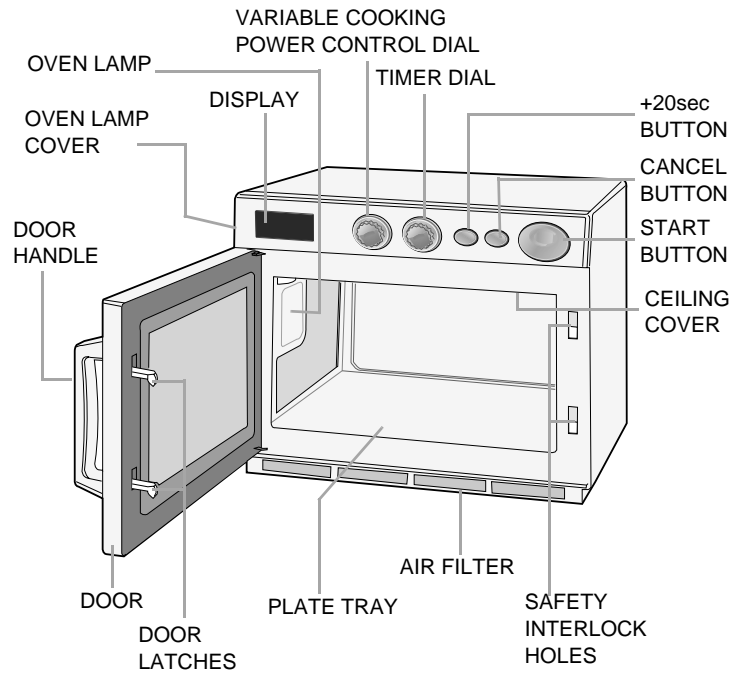

## DISPLAY

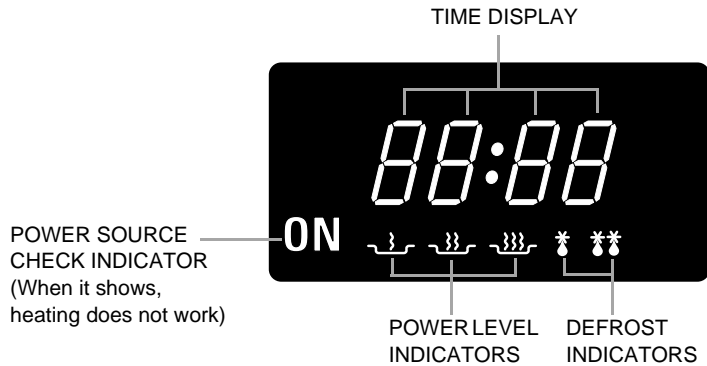

# Using this Instruction Booklet

You have just purchased a SAMSUNG microwave oven. Your Owner's Instructions contain valuable information on cooking with your microwave oven:

- Safety precautions
- Suitable accessories and cookware
- Useful cooking tips

At the front of the booklet you will find illustrations of the oven, and more importantly the control panel, so that you can find the buttons more easily.

The step-by-step procedures use two different symbols.



Important



Note

## PRECAUTIONS TO AVOID POSSIBLE EXPOSURE TO EXCESSIVE MICROWAVE ENERGY

Failure to observe the following safety precautions may result in harmful exposure to microwave energy.

- (a) Under no circumstances should any attempt be made to operate the oven with the door open or to tamper with the safety interlocks (door latches) or to insert anything into the safety interlock holes.
- (b) Do not place any object between the oven door and front face or allow food or cleaner residues to accumulate on sealing surfaces. Ensure that the door and door sealing surfaces are kept clean by wiping after use first with a damp cloth and then with a soft dry cloth.
- (c) Do not operate the oven if it is damaged until it has been repaired by a qualified microwave service technician trained by the manufacturer. It is particularly important that the oven door closes properly and that there is no damage to the:
  - (1) Door, door seals and sealing surfaces
  - (2) Door hinges (broken or loose)
  - (3) Power cable
- (d) The oven should not be adjusted or repaired by anyone other than a properly qualified microwave service technician trained by the manufacturer.

## Safety Precauciones

GB

*Before cooking food or liquids in your microwave oven, please check that the following safety precautions are taken.*

1. **DO NOT** use any metallic cookware in the microwave oven:

- Metallic containers
- Dinnerware with gold or silver trimmings
- Skewers, forks, etc.

**Reason:** Electric arcing or sparking may occur and may damage the oven.

2. **DO NOT** heat:

- Airtight or vacuum-sealed bottles, jars, containers  
Ex) Baby food jars
- Airtight food.  
Ex) Eggs, nuts in shells, tomatoes

**Reason:** The increase in pressure may cause them to explode.

**Tip:** Remove lids and pierce skins, bags, etc.

3. **DO NOT** operate the microwave oven when it is empty.

**Reason:** The oven walls may be damaged.

**Tip:** Leave a glass of water inside the oven at all times. The water will absorb the microwaves if you accidentally set the oven going when it is empty.

4. **DO NOT** cover the rear ventilation slots with cloths or paper.

**Reason:** The cloths or paper may catch fire as hot air is evacuated from the oven.

5. **ALWAYS** use oven gloves when removing a dish from the oven.

**Reason:** Some dishes absorb microwaves and heat is always transferred from the food to the dish. The dishes are therefore hot.

6. **DO NOT** touch heating elements or interior oven walls.

**Reason:** These walls may be hot enough to burn even after cooking has finished, even though they do not appear to be so. Do not allow inflammable materials to come into contact with any interior area of the oven. Let the oven cool down first.

7. To reduce the risk of fire in the oven cavity:

- Do not store flammable materials in the oven
- Remove wire twist ties from paper or plastic bags
- Do not use your microwave oven to dry newspapers.
- If smoke is observed, keep the oven door closed and switch off or disconnect the oven from the power supply

8. Take particular care when heating liquids and baby foods.

- ALWAYS allow a standing time of at least 20 seconds after the oven has been switched off so that the temperature can equalize.
- Stir during heating, if necessary, and ALWAYS stir after heating.
- Take care when handling the container after heating. You may burn yourself, if the container is too hot.
- A risk of delayed eruptive boiling exists.
- To prevent delayed boiling and possible scalding, you should put a plastic spoon or glass stick into the beverages and stir before, during and after heating.

**Reason:** During the heating of liquids the boiling point can be delayed; this means that eruptive boiling can start after the container is removed from the oven. You may scald yourself.

• In the event of scalding, follow these FIRST AID instructions:

- \* Immerse the scalded area in cold water for at least 10 minutes.
- \* Cover with a clean, dry dressing.
- \* Do not apply any creams, oils or lotions.

• **NEVER** fill the container to the top and choose a container that is wider at the top than at the bottom to prevent the liquid from boiling over. Bottles with narrow necks may also explode if overheated.

• **ALWAYS** check the temperature of baby food or milk before giving it to the baby.

• **NEVER** heat a baby's bottle with the teat on, as the bottle may explode if overheated. Tenga cuidado de no estropear el cable de alimentación.

9. Be careful not to damage the power cable.

- Do not immerse the power cable or plug in water and keep the power cable away from heated surfaces.
- Do not operate this appliance if it has a damaged power cable or plug.

10. Stand at arm's length from the oven when opening the door.

**Reason:** The hot air or steam released may cause scalding.

11. Keep the inside of the oven clean.

**Reason:** Food particles or spattered oils stuck to oven walls or floor can cause paint damage and reduce the efficiency of the oven.

12. You may notice a "Clicking" sound during operation (especially when the oven is in defrosting).

**Reason:** This sound is normal when the electrical power output is changing.

13. When the microwave oven is operating without any load, the power will be cut off automatically for safety. You can operate the oven normally after letting it stand for over 30 minutes.

## Safety Precautions (continued)

GB

### IMPORTANT SAFETY INSTRUCTIONS

During cooking, you should look into the oven from time to time when food is being heated or cooked in disposable containers of plastic, paper or other combustible materials.

### IMPORTANT

Young children should NEVER be allowed to use or play with the microwave oven. Nor should they be left unattended near the microwave oven when it is in use. Items of interest to children should not be stored or hidden just above the oven

## Installing Your Microwave Oven

*This microwave oven can be placed almost anywhere (kitchen work surface or shelf, movable trolley, table).*



For your personal safety, this appliance must be:

- Properly earthed (3-pin plug)
- Plugged into a standard 230 Volt, 50 Hz, AC earthed socket

1. Install the oven on a flat, level, stable surface. Make sure there is adequate ventilation for your oven by leaving at least 10cm (four inches) of space behind, on the sides of the oven and 20cm (eight inches) of above. (For stacking see page 9.)
2. Never block the air vents as the oven may overheat and automatically switch itself off. It will remain inoperable until it has cooled sufficiently.
3. Remove all packing materials inside the oven.
4. Plug the cable into a 3-pin, earthed socket. If the power cable of this appliance is damaged, it must be replaced by a special cable as supplied from service center.



Be sure to remove the protective film from outer case. The protective film is on the outer case to prevent scratches. When installing or before using, be sure to remove it.

### Outdoor Use

This microwave oven is not designed for outdoor use. You should use it indoors only.

### During Air Cooling

Do not turn power off while the cooling fan is automatically air-cooling for 1 min.

### Recommendations



DO NOT install the microwave oven in hot or damp surroundings. Example: Next to a traditional oven or radiator.



The power supply specifications of the oven must be respected and any extension cable used must be of the same standard as the power cable supplied with the oven.



Wipe the interior and the door seal with a damp cloth before using your microwave oven for the first time.

## Cooking / Reheating

**Make sure the oven is plugged into a properly earthed electrical outlet and "ON" appears in the display window.**

**Open the door (The oven lamp will be turned on.).**

**Put the food into a suitable container, place it in the centre of the oven and then close the door securely (The oven lamp will go off.).**

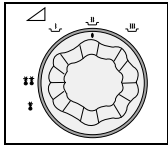

1. Select the desired power level by rotating the **COOKING POWER CONTROL DIAL**.

**Result :** The selected power level will be displayed in the display window.

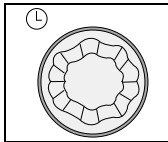

2. Set the desired heating time by rotating the **TIMER DIAL**.

**Result :** "ON" blinks and the selected time is displayed in the display window.

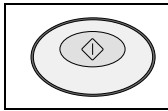

3. Press button:  
**Result :** The oven lamp and cooling fan will be turned on. Heating will start.  
The time on digital display will count down.

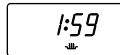

- When all time is elapsed, the end of cycle Beep Tone will sound 4 times and all heating will stop. The oven lamp will go off. For 1 min, the display shows '0' and the cooling fan will keep working in order to cool down the interior parts. During the time, the fan will not stop even when you open the door. 1 min later it will stop and "ON" appears again. Food may be removed from oven whilst the fan is still running.

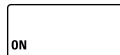

4. Open the door and take the food out. Close the door. The oven lamp will go off.

- Whilst heating, one press on pad stops the oven. You can restart it by pressing the pad or a second press on pad will cancel the selected program. When it is NOT in a heating cycle, one tap on pad cancels the selected program. You can set the power level first and then the cooking time next, or vice versa. You can press +20sec button one or more times in order to add the cooking time by 20 seconds.

- When heating cycle is completed and you open the door, the oven lamp automatically turns on and goes off 1 min later.

- When you open the door whilst in a heating cycle, the oven stops operating and the oven lamp automatically turns on for 1 min and goes off 1 min later. If you leave the oven door open for more than 1 min, the oven beeps once every minute and after 5 min the power source check indicator 'ON' appears in the display window.

- When in a heating cycle, you can not change the power level or heating time. But you can add 20 sec increments using the +20sec pad. The dial may be rotated but this does not affect the current operation and the display remains the same. It becomes effective next time you set the oven manually after you finish the current heating. If you want to change the current setting, firstly stop the heating by using CANCEL pad and set desired power level and cooking time again.

But when you are NOT in a heating cycle, you can change the power level and heating time. Changed values are promptly shown in the display.

- The oven is designed not to work when power level is set to "0" mode between the heating mode and the defrosting mode.

- When you first plug in the power cord, the oven beeps once and all the indicators show for 5 sec in the display window.

## Power Levels and Time Variations

The power level function enables you to adapt the amount of energy dissipated and thus the time required to cook or reheat your food, according to its type and quantity. You can choose between the power levels below.

Power Level	CM1919		CM1619		CM1319	
	Percentage	Output	Percentage	Output	Percentage	Output
HIGH (HIGH)	100 %	1850 W	100 %	1600 W	100 %	1300 W
MEDIUM (MEDIUM)	70 %	1295 W	70 %	1120 W	70 %	910 W
LOW (LOW)	50 %	925 W	50 %	800 W	50 %	650 W
HIGH DEFROST (HIGH DEFROST)	20 %	370 W	25 %	400 W	30 %	390 W
LOW DEFROST (LOW DEFROST)	10 %	185 W	13 %	208 W	15 %	195 W

The cooking times given in recipes and in this booklet correspond to the specific power level indicated.

Power Level	Max. Time
HIGH (HIGH)	25 min.
MEDIUM (MEDIUM)	40 min.
LOW (LOW)	40 min.
HIGH DEFROST (HIGH DEFROST)	50 min.
LOW DEFROST (LOW DEFROST)	50 min.

- ☒ The maximum time available per power level is shown in the table above.  
A defrosting time can be set up to 50 min. But the time is reduced to 25 min (for HIGH) or 40 min (for MEDIUM or LOW) the moment you change the current power level (DEFROST) to other level such as HIGH, MEDIUM or LOW.



Example: If you set a defrosting time to 45min with the heating mode at DEFROST and if you change the power level to HIGH, the time will be automatically reduced to 25min.

- ☒ You can set the power level first and the cooking time next, and vice versa.

## Stopping the Cooking

You can stop cooking at any time so that you can:

- Check the food
- Turn the food over or stir it
- Leave it to stand

To stop the cooking...	Then...
Temporarily	Open the door or press  pad once. <b>Result :</b> Cooking stops.
Completely	Press the  pad twice. <b>Result :</b> The cooking settings are cancelled.

☒ If you want to cancel any cooking settings before starting cooking, simply press **CANCEL**() once.

## Using +20sec Pad

This is a **ONE TOUCH COOK** button.

By touching the button once, you can start heating instantly.

You can increase the cooking time by pressing the +20sec button when in a heating cycle.

The cooking time increases by 20 seconds at each press on +20sec button. But it can not exceed the maximum time allowed for the power level selected.

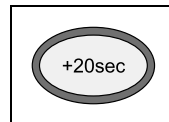

Before operating the oven, times can be increased using the **+20sec** button. During the operating, time may only be added by using the **+20sec** button.

## Adjusting the Cooking Time

Like traditional cooking, you may find that, depending on the food's characteristics or your tastes, you have to adjust the cooking times slightly. You can:

- Check how cooking is progressing at any time simply by opening the door
- Close the door
- Increase the remaining cooking time

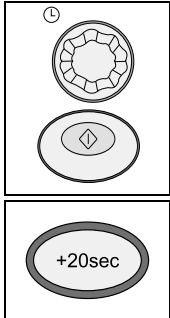

Before operating the oven, times can be increased/decreased using either the **TIMER** dial or **+20sec** button. During the operating, time may only be added by using the **+20sec** button.

## Using the Defrost Feature

The Defrost feature enables you to defrost meat, poultry or fish.

☞ Only use containers that are microwave-safe.

Open the door. Place the frozen food in the centre of the plate tray. Close the door.

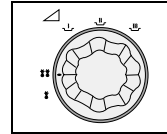

1. Press the Variable Cooking Power Control dial to the **DEFROST HIGH (☼☼)** or **DEFROST LOW (☼)** as you wish.

Result : The DEFROST indicator appears in the display.

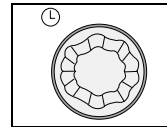
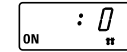

2. Rotate the **TIMER** dial to set the defrosting time.

☒ The Maximum time that can be set under defrosting mode is 50min.

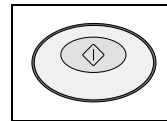

3. Press **◇** button.

Result : Defrosting begins.

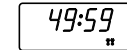

## Error Codes

GB

Erroe Items	Code	Error Beep	Cause	Remedy
<b>Power frequency Error (50/60Hz)</b>	E1	One long beep for 2 sec	Power frequency is other than 50 Hz.	Unplug the power cord plug and check if the power frequency is 50 Hz.  Plug the power cord in 50 Hz power source and see if "E1" appears. If the error code is displayed again even after the correct power source is provided, contact the nearest service centre.
<b>Thermistor Open Error</b>	E21	One long beep for 2 sec	Thermistor Sensor which is supposed to sense the temperature of the cavity inside does not work properly. (Thermistor Sensor open)	Unplug the power cord and wait for more than 10 seconds. Plug the power cord again. If the symptom persists, contact the nearest service centre.
<b>Thermistor Short Error</b>	E22	One long beep for 2 sec	Thermistor Sensor which is supposed to sense the temperature of the cavity inside does not work properly. (Thermistor Sensor short)	Unplug the power cord and wait for more than 10 seconds. Plug the power cord again. If the symptom persists, contact the nearest service centre.
<b>Temperature of exhaust air too High Error</b>	E3	One long beep for 2 sec	The oven cavity gets too hot due to excessive operation with no load or small load, or due to some blocking materials around the Air Filter or Air Exhaust at the back of the oven.	Open the oven door and check if 1) the oven has been operating with no load or too small load, 2) the air filter is placed in a wrong position, or 3) any blocking materials exist around the Air Exhaust. Cool down the oven (for approx. 30 min) under the normal temperature. The oven is back to normal when the error code "E3" disappears and "ON" appears again in the display window.  Unplug the power cord, remove the blocking materials around the ventilation openings, cool down the oven (for approx. 30 min) sufficiently, plug the power cord in again and check if the error code appears again.  If the symptom persists even when the oven is cooled down sufficiently, contact the nearest service centre.
<b>HVT-I Power Error</b>	E41	One long beep for 2 sec	The circuitry inside the oven is not working correctly.	Unplug the power cord and wait for 10 seconds. Plug the power cord in again and check if the error code "E41" appears again. If the symptom persists, contact the nearest service centre.
<b>HVT-II Power Error</b>	E42	One long beep for 2 sec	The circuitry inside the oven is not working correctly.	Unplug the power cord and wait for 10 seconds. Plug the power cord in again and check if the error code "E42" appears again. If the symptom persists, contact the nearest service centre.



# Care of Your Microwave Oven

## Cleaning the Microwave Oven

1. Unplug the oven from the electrical socket before cleaning.
2. Clean the inside of the oven. Wipe up all spills with a damp cloth. Kitchen detergent solution may be used if the oven gets too dirty. Do not use harsh detergents or abrasives.
  - ☒ If food remnant or spilled liquids stick to the oven walls, or between door seal and door surface, they will absorb microwaves possibly resulting in arcing or sparks.
3. Clean the outside of the oven with soap and water, then dry with a soft cloth.  
**Caution:** Make sure that water does not get into the back ventilation or control panel opening.
4. When you clean the window of the door, be sure to use a soft cloth after washing with very mild soap and water. Do not use window cleaner as the front door can be scratched by harsh soap or cleaners.

## Cleaning the Ceiling Cover

1. Hold side stoppers of ceiling cover with both hands and pull them in and down. Then take the ceiling cover out of the oven cavity.
2. Rinse ceiling cover in soapy water or Food Sanitizer Solution.
3. Be sure to replace the ceiling cover before using the oven.

**Caution :** Ceiling cover must be in place securely when you use the oven. When you removed the Ceiling Cover for the purpose of cleaning, be sure to be extremely careful about the exposed inside components on the top of the oven cavity. If any of them are deformed, abnormal symptom can happen such as arcing or sparks during operation. In case of such problem, contact the nearest after-sales service centre.

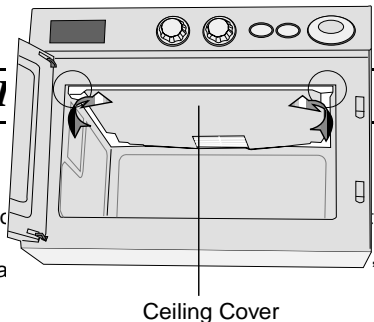

## Installation

### Important

1. Disconnect the power before attempting installation.
2. For stacking installation with this unit, which is enclosed

## Cleaning the Air Filter

**Clean the Air Filter regularly according to the following instructions. The oven may have problems when the Air Filter becomes clogged with dust.**

1. Remove the bolt at both ends of the Air Filter.
2. Lift the Air Filter off the post carefully.
3. Wash this filter in warm soapy water.
4. Be sure to replace the Air Filter before using the oven.

☒ If the Air Filter becomes clogged with debris, this will cause an overheating problem on the oven.

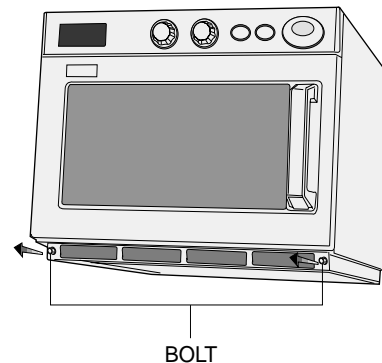

3. The maximum stacking height is two units.
  - ☒ Stacking the two units is limited to the following models.**CAUTION: Be sure the oven cavity is empty.**

## Installation

1. Stack two units together.

2. Remove 6 screws as shown in the figure.
3. Place the Bracket-plate to join the two units.
- GB** 4. Attach and tighten 6 screws as shown in the figure here.
5. Ensure the top oven is at a safe and workable height.

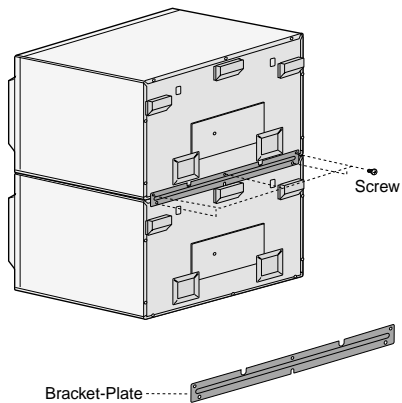

---

## Replacement of Lamp

---

### Important

1. Remove a screw securing the lamp cover.
  - ✘ You don't need to remove outer panel to replace lamp.
2. Remove the lamp by rotating it clockwise.
3. Replace with a new lamp by rotating it counter-clockwise.

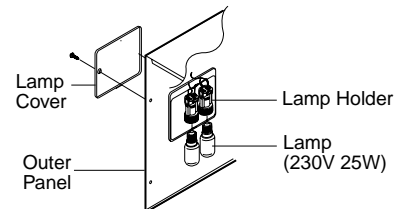

## Cookware Guide

To cook food in the microwave oven, the microwaves must be able to penetrate the food, without being reflected or absorbed by the dish used.

Care must therefore be taken when choosing the cookware. If the cookware is marked microwave-safe, you do not need to worry.

The following table lists various types of cookware and indicates whether and how they should be used in a microwave oven.

Cookware	Microwave-Safe	Comments
<b>Aluminium foil</b>	✓ X	Can be used in small quantities to protect areas against overcooking. Arcing can occur if the foil is too close to the oven wall or if too much foil is used.
<b>China and earthenware</b>	✓	Porcelain, pottery, glazed earthenware and bone china are usually suitable, unless deco-rated with a metal trim.
<b>Disposable polyester cardboard dishes</b>	✓	Some frozen foods are packaged in these dishes.
<b>Fast-food packaging</b>		
• Polystyrene cups containers	✓	Can be used to warm food. Overheating may cause the polystyrene to melt.
• Paper bags or newspaper	X	May catch fire.
• Recycled paper or metal trims	X	May cause arcing.
<b>Glassware</b>		
• Oven-to-table ware	✓	Can be used, unless decorated with a metal trim.
• Fine glassware	✓	Can be used to warm foods or liquids. Delicate glass may break or crack if heated suddenly.
• Glass jars	✓	Must remove the lid. Suitable for warming only.
<b>Metal</b>		
• Dishes	X	May cause arcing or fire.
• Freezer bag twist ties	X	

### Paper

- |   |   |  |
|---|---|--|
| • Plates, cups, napkins and Kitchen paper | ✓ | For short cooking times and warming. Also to absorb excess moisture. |
| • Recycled paper                          | X | May cause arcing.  |

### Plastic

- |                |     |  |
|----------------|-----|--|
| • Containers   | ✓   | Particularly if heat-resistant thermoplastic. Some other plastics may warp or discolour at high temperatures. Do not use Melamine plastic. |
| • Cling film   | ✓   | Can be used to retain moisture. Should not touch the food. Take care when removing the film as hot steam will escape.                      |
| • Freezer bags | ✓ X | Only if boilable or oven-proof. Should not be airtight. Prick with a fork, if necessary.   |

### Wax or grease-proof paper

✓

Can be used to retain moisture and prevent spattering.

✓ : Recommended

✓ X : Use Caution

X : Unsafe

# Cooking Guide

GB

F : Frozen

C : Chilled

Recipe	Method	Power Level	Timing			Stand Time
			1850W	1600W	1300W	
<b>BREAD &amp; PASTRIES</b>						
<b>To Defrost</b>						
Vienna Baton 9" F		DEFROST 1(★★)	0'45"	0'50"	0'50"	5 mins
Vienna Baton 9" X 2 F		DEFROST 1(★★)	1'10"	1'15"	1'20"	5 mins
Gateaux, ind. Slice F	Place on plate	DEFROST 2(★)	2'30"	2'40"	2'50"	5 mins
<b>To warm</b>						
Quiche 11" sliced 136g	Place on plate	DEFROST 1(★★) HIGH	3'00"	3'00"	3'00"	1 min
Mince pies ind. X 2 F	Remove from tin foil Place on plate	HIGH	0'10"	0'15"	0'15"	1 min
Fruit pie F	Place on plate	HIGH	0'40"	0'45"	0'45"	1 min
Croissant X 2 F	Place on plate	HIGH	0'05"	0'10"	0'10"	1 min
Pastry, baked 227g C	Place on plate	HIGH	0'45"	0'55"	1'00"	1 min
Chicken & mushroom pie X 2 C	Remove foil. Place on plate	HIGH	0'45"	0'55"	1'00"	1 min
Chicken & mushroom pie C	Place on plate, remove foil	HIGH	0'30"	0'40"	0'45"	1 min
<b>SNACK &amp; STARTERS</b>						
<b>To cook</b>						
Bacon, rasher C	Place on rack	HIGH	1'30"	1'40"	1'50"	1 min
Eggs, poached X 2 C	Place in ramekins	HIGH	0'30"	0'40"	0'45"	1 min
Eggs, scrambled X2 C	Beat eggs and place in bowl	HIGH	25"-30"	30"-40"	35"-45"	1 min
Sausages X 2 Thick C	Pierce	MED	1'00"	1'10"	1'20"	2 mins

Recipe	Method	Power Level	Timing			Stand Time
			1850W	1600W	1300W	
<b>SNACK &amp; STARTERS</b>						
<b>To Reheat</b>						
Sausages Cumberland F	Place on plate	MED	2'00"	2'10"	2'20"	2 mins
Full breakfast C	Cover	MED	2'30"	2'40"	2'50"	1 min
Beefburgers F		HIGH	0'55"	1'05"	1'10"	1 min
Chickenburger F		HIGH	0'55"	1'05"	1'10"	1 min
Donner kebab 162g F		HIGH	1'00"	1'10"	1'20"	1 min
Hot Dog F		HIGH	1'00"	1'10"	1'20"	1 min
Pizza 190g F	Place on plate	LOW	2'30"	2'45"	3'00"	2 mins
Chargrilled ribs 200g F	Place on plate	MED	3'30"	3'45"	4'00"	1 min
Wings of fire X 6 F	Arrange on plate, thin parts to center	HIGH	2'00"	2'15"	2'30"	1 min
Baked Beans 500g	Cover and Stir half way	HIGH	2'00"	2'10"	2'20"	2 mins
Baked Beans 250g	Cover and Stir half way	HIGH	1'00"	1'05"	1'10"	2 mins
<b>DESSERTS</b>						
<b>To warm</b>						
Apple Crumble 200g F	Cover in dish	HIGH	1'20"	1'30"	1'40"	2 mins
Christmas Pudding 150g C	Place in bowl	HIGH	0'20"	0'25"	0'30"	2 mins
Jam Roly Poly 80g F	On a plate	HIGH	1'00"	1'05"	1'10"	2 mins
Crepes Suzette 2 F	Pierce film	HIGH	0'50"	1'00"	1'10"	1 min
Suet Sponge pudding F	X 2 X 1	HIGH HIGH	0'35" 0'40"	1'05" 0'50"	1'30" 1'00"	2 mins 2 mins
Sponge pudding F	X 2 X 1	HIGH HIGH	0'35" 0'40"	1'05" 0'45"	1'30" 0'45"	2 mins 2 mins

Printed in Korea

## Cooking Guide (continued)

F : Frozen

C : Chilled

Recipe	Method	Power Level	Timing			Stand Time
			1850W	1600W	1300W	
<b>RECIPES DISH ENTREES</b>						
<b>To Reheat</b>						
Amorini & Stilton bake C	Place in microwave safe dish	HIGH	3'30"	3'40"	3'50"	1 min
Chicken Tikka masala F	Pierce film	HIGH	3'20"	3'30"	3'40"	2 mins
Thai Green Chicken curry F	Pierce film	HIGH	3'00"	3'15"	3'30"	2 mins
Chilli con Carne F	Pierce film	HIGH	3'30"	3'45"	4'00"	2 mins
Chicken cooked 1/2 Chilled	Place in m/w in pierced bag	MED	4'30"	5'00"	5'30"	2 mins
Lasagne 192g	Place in microwave safe dish	MED	4'00"	4'15"	4'30"	2 mins
Moules Marinieres 466g F	Pierce bag	HIGH	2'30"	2'45"	3'00"	2 mins
Salmon & Avacodo Paupiette C	Pierce bag	HIGH	2'30"	2'45"	3'00"	2 mins
Shepherd's pie 300g C	Place in oven and cover	MED	3'00"	3'15"	3'30"	2 mins
Suet puddings chilled	Cover - place upright on microwave safe plate	LOW	4'00"	4'20"	4'40"	2 mins
Supreme of chicken in red pesto 312g F	Pierce bag place on plate	DEFROST	5'00"	5'00"	5'00"	1 min
		HIGH	3'30"	3'45"	4'00"	
Tagliatelle carbonara C	Pierce film, place on plate	HIGH	1'40"	2'00"	2'20"	1 min
Tortellini formaggio C	Place in dish and cover	HIGH	2'00"	2'15"	2'30"	1 min
Vegetable Cumberland Pie C	Place in microwave safe dish	HIGH	3'20"	3'35"	3'50"	1 min
Plated Meal 350g C	Covered	HIGH	2'00"	2'15"	2'30"	1 min
Plated Meal 700g C	Covered	HIGH	3'00"	3'15"	3'30"	1 min

GB

Recipe	Method	Power Level	Timing			Stand Time
			1850W	1600W	1300W	
<b>FRESH VEGETABLES</b>						
<b>To cook 500g</b>						
Beans, green sliced	60ml/4tbsps water cover	HIGH	3'00"	3'15"	3'30"	2 mins
Broccoli, florets	60ml/4tbsps water cover	HIGH	3'00"	3'15"	3'30"	2 mins
Cabbage, shredded	10tbsps water cover	HIGH	5'00"	5'30"	6'00"	2 mins
Carrots, sliced	60ml/4tbsps water cover	HIGH	3'30"	3'45"	4'00"	2 mins
Cauliflower, florets	60ml/4tbsps water cover	HIGH	3'30"	3'45"	4'00"	2 mins
Whole Green beans	60ml/4tbsps water cover	HIGH	3'30"	3'45"	4'00"	2 mins
Potatoes, jacket	Turn half way	HIGH	10'00"	11'00"	12'00"	5 mins
Sprouts	60ml/4tbsps water cover	HIGH	4'30"	4'45"	5'00"	2 mins
Beans, green sliced	Cover, stir half way through cooking	HIGH	3'00"	3'15"	3'30"	2 mins
Beans, whole	Cover, stir half way	HIGH	4'00"	4'15"	4'30"	2 mins
Broccoli Florets	Cover, stir half way	HIGH	4'00"	4'15"	4'30"	2 mins
Cabbage, shredded	Cover, stir half way	HIGH	4'00"	4'15"	4'30"	2 mins
Carrot batons	Cover, stir half way	HIGH	4'00"	4'15"	4'30"	2 mins
Cauliflower, florets	Cover, stir half way	HIGH	4'00"	4'15"	4'30"	2 mins
Corn on the Cob	Cover	HIGH	4'00"	4'30"	5'00"	2 mins
Corn, whole baby	Cover, stir half way	HIGH	5'00"	5'15"	5'30"	2 mins
Mushrooms, whole	Cover, stir half way	HIGH	3'00"	3'15"	3'30"	2 mins

## Cooking Guide (continued)

GB

F : Frozen

C : Chilled

Recipe	Method	Power Level	Timing			Stand Time
			1850W	1600W	1300W	
<b>FRESH VEGETABLES</b>						
<b>To cook 500g</b>						
Potatoes, jacket 230~290g X 1		HIGH	3'00"	4'00"	4'30"	2 mins
Potatoes, Mashed X 2		HIGH	6'00"	6'30"	7'00"	2 mins
Potatoes, Mashed X 4		HIGH	10'00"	11'15"	12'30"	2 mins
Ratatouille 500g		HIGH	3'30"	4'00"	4'30"	2 mins
Sprouts	Cover, stir half way	HIGH	3'00"	3'30"	4'00"	2 mins
<b>RICE, 500g</b>						
<b>To Reheat</b>						
Rice, boiled F	Cover, stir half way	HIGH	3'00"	3'15"	3'30"	2 mins
Rice, Pilau F	Cover, stir half way	HIGH	3'00"	3'15"	3'30"	2 mins

## Cleaning Your Microwave Oven

The following parts of your microwave oven should be cleaned regularly to prevent grease and food particles from building up:

- **Inside and outside surfaces**
- **Door and door seals**
- **Plate tray**



**ALWAYS** ensure that the door seals are clean and the door closes properly.

1. Clean the outside surfaces with a soft cloth and warm, soapy water. Rinse and dry.
2. Remove any splashes or stains on the inside surfaces with a soapy cloth. Rinse and dry.
3. To loosen hardened food particles and remove smells, place a cup of diluted lemon juice on the plate tray and heat for three minutes at maximum power.



**DO NOT** spill water in the vents.



**NEVER** use any abrasive products or chemical solvents.



Take particular care when cleaning the door seals to ensure that no particles:

- Accumulate
- Prevent the door from closing correctly



**Clean the** microwave oven cavity right after each use with a mild detergent solution, but let the microwave oven cool down before cleaning in order to avoid injury .

## Storing and Repairing Your Microwave Oven

A few simple precautions should be taken when storing or having your microwave oven serviced.

The oven must not be used if the door or door seals are damaged:

- Broken hinge
- Deteriorated seals
- Distorted or bent oven casing

Only a qualified microwave service technician should perform repairs.

- ✎ **NEVER** remove the outer casing from the oven. If the oven is faulty and needs servicing or you are in doubt about its condition:
  - Unplug it from the wall socket
  - Contact the nearest after-sales service centre

## Technical Specifications

SAMSUNG strives to improve its products at all times. Both the design specifications and these user instructions are thus subject to change without notice.

GB

Model	CM1919	CM1619	CM1319
Power source	230 V ~ 50 Hz		
Power consumption Microwave	3200 W	3000 W	2600 W
Output power	1850 W (IEC-705) <b>240 V: 1850 W</b> <b>230 V: 1780 W</b>	1600W (IEC-705) <b>240 V: 1600 W</b> <b>230 V: 1540 W</b>	1300W (IEC-705) <b>240 V: 1300 W</b> <b>230 V: 1250 W</b>
Operating frequency	2, 450 MHz		
Dimensions (W x H x D) Outside	464 x 368 x 557 mm		
Oven cavity	370 x 190 x 370 mm		
Volume	26 litre		
Weight Net	32 Kg approx.		

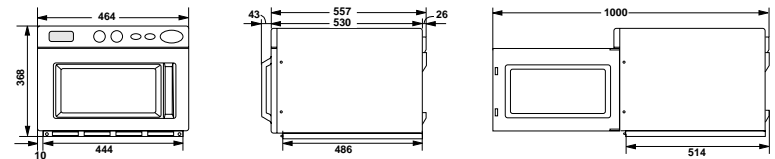





## Free Manuals Download Website

<http://myh66.com>

<http://usermanuals.us>

<http://www.somanuals.com>

<http://www.4manuals.cc>

<http://www.manual-lib.com>

<http://www.404manual.com>

<http://www.luxmanual.com>

<http://aubethermostatmanual.com>

Golf course search by state

<http://golfingnear.com>

Email search by domain

<http://emailbydomain.com>

Auto manuals search

<http://auto.somanuals.com>

TV manuals search

<http://tv.somanuals.com>