

SAMSUNG

Microwave Oven

Owner's Manual

**M198SCE
M1D8SCE**



Code No. : DE68-01537A

Download from www.Somanuals.com. All Manuals Search And Download.

PRECAUTIONS TO AVOID POSSIBLE EXPOSURE TO EXCESSIVE MICROWAVE ENERGY

Failure to observe the following safety precautions may result in harmful exposure to microwave energy.

- (a) Under no circumstances should any attempt be made to operate the oven with the door open or to tamper with the safety interlocks (door latches) or to insert anything into the safety interlock holes.
- (b) Do not place any object between the oven door and front face or allow food or cleaner residues to accumulate on sealing surfaces. Ensure that the door and door sealing surfaces are kept clean by wiping after use first with a damp cloth and then with a soft dry cloth.
- (c) Do not operate the oven if it is damaged until it has been repaired by a qualified microwave service technician trained by the manufacturer.
It is particularly important that the oven door closes properly and that there is no damage to the:
 - (1) Door, door seals and sealing surfaces
 - (2) Door hinges (broken or loosened)
 - (3) Power cable
- (d) The oven should not be adjusted or repaired by anyone other than a properly qualified microwave service technician trained by the manufacturer.

Before cooking food or liquids in your microwave oven, please check that the following safety precautions are taken.

1. Utensils should be checked to ensure that they are suitable for use in microwave ovens as below.
DO NOT use any metallic cookware in the microwave oven :
 - ◆ Metallic containers
 - ◆ Dinnerware with gold or silver trimmings
 - ◆ Skewers, forks, etc.**Reason :** Electric arcing or sparking may occur and may damage the oven.
2. **DO NOT** heat:
 - ◆ Airtight or vacuum-sealed bottles, jars, containers
Ex) Baby food jars
 - ◆ Airtight food.
Ex) Eggs, nuts in shells, tomatoes**Reason :** The increase in pressure may cause them to explode.
Tip : Remove lids and pierce skins, bags, etc.
3. **DO NOT** operate the microwave oven when it is empty.
Reason : The oven walls may be damaged.
Tip : Leave a glass of water inside the oven at all times. The water will absorb the microwaves if you accidentally set the oven going when it is empty.
4. **DO NOT** cover the rear ventilation slots with cloths or paper.
Reason : The cloths or paper may catch fire as hot air is evacuated from the oven.
5. **ALWAYS** use oven gloves when removing a dish from the oven.
Reason : Some dishes absorb microwaves and heat is always transferred from the food to the dish. The dishes are therefore hot.
6. **DO NOT** touch heating elements or interior oven walls.
Reason : These walls may be hot enough to burn even after cooking has finished, although they do not appear to be so. Do not allow inflammable materials to come into contact with any interior area of the oven.
Let the oven cool down first.

SAFETY PRECAUTIONS (continued)

7. To reduce the risk of fire in the oven cavity:
 - ◆ Do not store flammable materials in the oven
 - ◆ Remove wire twist ties from paper or plastic bags
 - ◆ Do not use your microwave oven to dry newspapers
 - ◆ If smoke is observed, keep the oven door closed and switch off or disconnect the oven from the power supply
8. Take particular care when heating liquids and baby foods.
 - ◆ ALWAYS allow a standing time of at least 20 seconds after the oven has been switched off so that the temperature can equalize.
 - ◆ Stir during heating, if necessary, and ALWAYS stir after heating.
 - ◆ Take care when handling the container after heating. You may burn yourself, if the container is too hot.
 - ◆ A risk of delayed eruptive boiling exists.
 - ◆ To prevent delayed boiling and possible scalding, you should put a plastic spoon or glass stick into the beverages and stir before, during and after heating.

Reason : During the heating of liquids the boiling point can be delayed; this means that eruptive boiling can start after the container is removed from the oven. You may scald yourself.
 - ◆ In the event of scalding, follow these FIRST AID instructions:
 - Immerse the scalded area in cold water for at least 10 minutes.
 - Cover with a clean, dry dressing.
 - Do not apply any creams, oils or lotions.
 - ◆ NEVER fill the container to the top and choose a container that is wider at the top than at the bottom to prevent the liquid from boiling over. Bottles with narrow necks may also explode if overheated.
 - ◆ ALWAYS check the temperature of baby food or milk before giving it to the baby.
 - ◆ NEVER heat a baby's bottle with the teat on, as the bottle may explode if overheated.
9. Be careful not to damage the power cable.
 - ◆ Do not immerse the power cable or plug in water and keep the power cable away from heated surfaces.
 - ◆ Do not operate this appliance if it has a damaged power cable or plug.
10. Stand at arm's length from the oven when opening the door.

Reason : The hot air or steam released may cause scalding.

11. Keep the inside of the oven clean.

Reason : Food particles or spattered oils stuck to oven walls or floor can cause paint damage and reduce the efficiency of the oven.
12. "Clicking" sound might be noticed while operating, especially at defrosting mode.

Reason : When the electrical power output is changing, you may hear that sound. This is normal.
13. When the microwave oven is operating without any load, the power will be cut off automatically for safety. You can operate normally after letting it stand for over 30 minutes.

IMPORTANT SAFETY INSTRUCTIONS

During cooking, you should look into the oven from time to time when food is being heated or cooked in disposable containers of plastic, paper or other combustible materials.

IMPORTANT

Young children should NEVER be allowed to use or play with the microwave oven. Nor should they be left unattended near the microwave oven when it is in use. Items of interest to children should not be stored or hidden just above the oven.

WARNING:

If the door or door seals are damaged, the oven must not be operated until it has been repaired by a competent person.

WARNING:

It is hazardous for anyone other than a competent person to carry out any service or repair operation which involves the removal of a cover which gives protection against exposure to microwave energy.

WARNING:

Liquids and other foods must not be heated in sealed containers since they are liable to explode.

WARNING:

Only allow children to use the oven without supervision when adequate instructions have been given so that the child is able to use the oven in a safe way and understands the hazards of improper use.

Please recycle or dispose of the packaging material for this product in an environmentally responsible manner.

INSTALLING YOUR MICROWAVE OVEN

Place the oven on a flat, level surface strong enough to safely bear the weight of the oven.

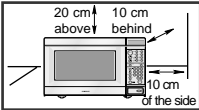

- 1 When you install your oven, Make sure there is adequate ventilation for your oven by leaving at least 10 cm (4 inches) of space behind, on the sides of the oven and 20 cm (8 inches) of above.

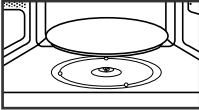

- 2 Remove all packing materials inside the oven.
Install the roller ring and turntable.
Check that the turntable rotates freely.

- * **Never** block the air vents as the oven may overheat and automatically switch itself off. It will remain inoperable until it has cooled sufficiently.
- * For your personal safety, plug the cable into a 3-pin, 240 Volt, 50Hz, AC earthed socket. If the power cable of this appliance is damaged, it must be replaced by a special cable KDK(KKP-550A). Contact your local dealer to have it replaced.
- * **Do not** install the microwave oven in hot or damp surroundings like next to a traditional oven or radiator. The power supply specifications of the oven must be respected and any extension cable used must be of the same standard as the power cable supplied with the oven. Wipe the interior and the door seal with a damp cloth before using your microwave oven for the first time.

Cooking Principle

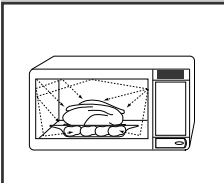

- 1 The microwaves generated by the magnetron are distributed uniformly as the food rotates on the turntable. The food is thus cooked evenly.
- 2 The microwaves are absorbed by the food up to a depth of about 1 inch (2.5 cm). Cooking then continues as the heat is dissipated within the food.
- 3 Cooking times vary according to the recipient used and the properties of the food:
 - ◆ Quantity and density
 - ◆ Water content
 - ◆ Initial temperature (refrigerated or not)



As the centre of the food is cooked by heat dissipation, cooking continues even when you have taken the food out of the oven. Standing times specified in recipes and in this booklet must therefore be respected to ensure:

- ◆ Even cooking of the food right to the centre
- ◆ The same temperature throughout the food

CONTENTS

Your New Microwave Oven	6	Cooking Instructions	16
Checking Parts	6	Cooking Utensils	16
Setting Up Your Microwave Oven . . .	6	Testing Utensils	16
Control Panel Buttons	7	Cooking Techniques	17
Operation	8	General Tips	17
Turning on the Power and Selecting a Display Language	8	Auto Sensor Cook	18
Setting the Clock	8	Utensils & Cover For Sensor Cooking	18
Using the Pause/Cancel Button	8	Important	18
Using the Help System	9	Cooking Guides	19-20
Using the Sensor Cook Buttons	9	Sensor Cooking Guide	21-22
Using the One Minute+ Button . . .	10	Sensor Reheat Guide	22
Using the Gentle Cook Button	10	Sensor Recipes	23-24
Sensor Reheat	10	Appendix	25
Defrosting Automatically	11	Troubleshooting Guide	25
Defrosting Guide	12	Care and Cleaning	25
Setting Cooking Times & Power Levels	13	Specifications	26
One-stage Cooking	13		
Multi-stage Cooking	13		
Using the More/Less Button	14		
Adjusting the Volume	14		
Using the Kitchen Timer	15		
Setting the Child Protection Lock . .	15		
Demonstration Mode	15		

YOUR NEW MICROWAVE OVEN

Checking Parts

Unpack your microwave oven and check to make sure that you have all the parts shown here. If any part is missing or broken, call your dealer.

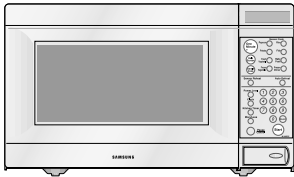

microwave oven



glass tray



instruction manual



roller guide ring



warranty card

Thank You for Choosing Samsung

Your new oven represents the latest in microwave cooking technology. This oven is a full-featured, easy-to-use appliance built to strict quality standards set by Samsung — the highest in the industry. We're proud to offer you a product that will provide convenient, dependable service for years to come.

Please record the serial number from the back of your Samsung microwave oven and the date of purchase in the space provided below. We recommend that you keep your purchase receipt with this manual for easy warranty service.

Model Number _____

Serial Number _____

Date Purchased _____

Dealer _____

Setting Up Your Microwave Oven

- 1 Place the oven on a flat, sturdy surface and plug the cord into a grounded outlet. Once plugged in, the display on your oven will show:

SAMSUNG 50 SIMPLE

- 2 Open the oven door by pressing the button below the control panel.
- 3 Wipe the inside of the oven with a damp cloth.
- 4 Place the pre-assembled ring in the indentation in the center of the oven.

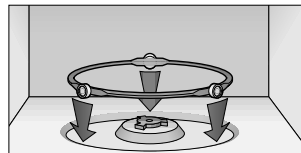

- 5 Place the glass tray on top of the ring so that the three glass tabs in the center of the tray fit securely into the tabs on the floor of the oven.

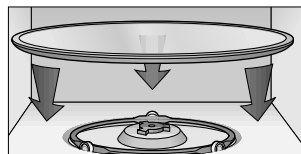

Control Panel Buttons

One Minute+ p. 10
Press once for every minute of cooking at High power.

Sensor Cook Buttons p. 9
Sensor settings to cook popular foods.

Help Screen p. 9
Press to see help information about the feature you are using.

Gentle Cook p. 10
Press to set gentler cooking with reduced power

Sensor Reheat p. 10

Auto Defrost p. 11
Sets weight of food to be defrosted.

Power Level p. 13
Sets power to level other than high.

Clock p. 8
Sets current time.

Number Buttons
Sets cooking times or amounts and power levels other than high.

Kitchen Timer p. 15

More/Less Button p. 14
Increases or decreases cooking time.

Sound Button p. 14

Pause/Cancel p. 8
Press to pause oven or correct a mistake.

Start
Press to start cooking.

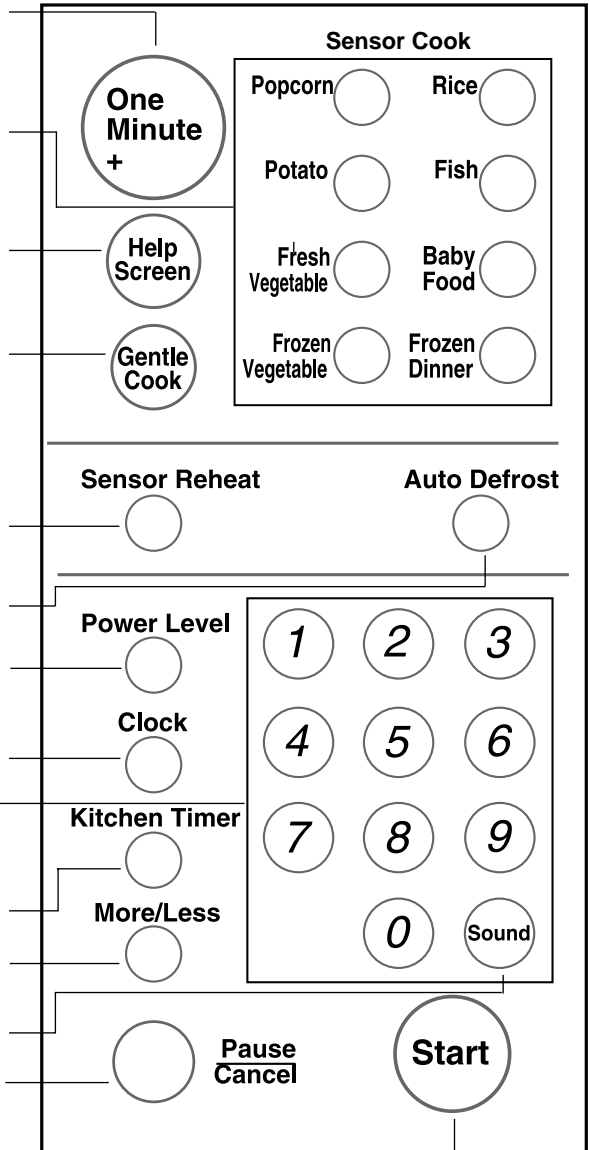

Turning on the Power and Selecting a Display Language

The first time you plug the power cord into an outlet, or after there has been an interruption in power, the display shows "SAMSUNG SO SIMPLE." At this point, you can select a language and weight system for the display. You can choose from English, French, Spanish and Portuguese and between pounds (LBS) or kilograms (KG). To do so,

- 1 Press **START** immediately after plugging in your Microwave. The display shows "ENGLISH/LBS". If the display does not show "ENGLISH/LBS", you will need to unplug the Microwave and then plug it in again to change the language.

ENG/LBS HELP

- 2 Press **START** repeatedly to select the language and weight system you wish to use:

- ENGLISH/LBS,
- ENGLISH/KG,
- FRENCH/KG,
- SPANISH/LBS, or SPANISH/KG
- PORTUGUESE/KG.

If you continue to press **START**, the settings will cycle in the order shown here.

ENG/KG HELP

FRN/KG HELP

SPN/LBS HELP

SPN/KG HELP

POR/KG HELP

When you have selected the language and weight system you want to use, press the **PAUSE/CANCEL** button to end this procedure, or press **CLOCK** to set the clock.

Setting the Clock

- 1 Press the **Clock** button. The display will show:

SET CURRENT TIME

- 2 Use the number buttons to enter the current time. You must press at least three numbers to set the clock. If the current time is 5:00 enter, 5,0,0.

500

- 3 Press **Clock** again. A colon will appear, indicating that the time is set.

If there is a power interruption, you will need to reset the clock.

*You can check the current time while cooking is in progress by pressing the **Clock** button.*

Using the Pause/Cancel Button

The **Pause/Cancel** button allows you to clear instructions you have entered. It also allows you to pause the oven's cooking cycle, so that you can check the food.

- To pause the oven during cooking: press **Pause/Cancel** once. To restart, press **Start**.
- To stop cooking, erase instructions, and return the oven display to the time of day: press **Pause/Cancel** twice.
- To correct a mistake you have just entered: press **Pause/Cancel** once, then re-enter the instructions.
- To cancel a timer setting: press **Pause/Cancel** once.

Using the Help system

Your microwave offers helpful instructions for many procedures.

- 1 When you need feature information and helpful hints, press the **Help Screen** button and then press the button that you want to get information on. Help information is available in 4 languages (English, French, Spanish and Portuguese).

Using the Sensor Cook Buttons

By actually sensing the steam that escapes as food heat, this feature automatically adjusts the oven's heating time for various types and amounts of pre-cooked food.

- 1 Press the **Sensor** button corresponding to the food you are cooking (**Popcorn**, for example). The display shows "POPCORN" and your microwave oven will begin cooking automatically.



Serving sizes available for each button:

POPCORN 100 -115 g	POTATO 1-6 ea (200 g each)
FRESH VEGETABLE 1 - 4 CUPS	FROZEN DINNER (Frozen Entree, Frozen Dinner) 200-500g
RICE 100-300 g rice	BABY FOOD 100-200 g
FROZEN VEGETABLE 1-4 cups	FISH 250-750 g

When cooking popcorn, wait at least five minutes between each bag to avoid overheating the glass tray. If you want to adjust the cooking time, you can use the MORE/LESS button. See page 14 for more information. If you want to check the current time while cooking is in progress, press the CLOCK button.

Using the One Minute+ Button

This button offers a convenient way to heat food in one-minute increments at the High power level.

- 1 Press the **One Minute+** button once for each minute you wish to cook the food. *For example, press it twice for two minutes.* The time will display, and the oven starts automatically.

*Add minutes to a program in progress by pressing the **One Minute+** button for each minute you want to add.*

Using the Gentle Cook Button

This button is for slower, gentler cooking with reduced power. It is ideal for heat sensitive foods such as those containing egg yolks, sour cream and mayonnaise and for simmering stews, etc.

- 1 Use the **Number** button to set a cooking time. *For example, to set 10 minutes, enter 1,0,0,0.*



- 2 Press the **Gentle Cook** button. The time will display and the oven will start automatically.



Sensor Reheat

Heating leftovers and precooked foods is easy with your new microwave. By actually sensing the steam that escapes as food heat, this feature automatically adjusts the oven's heating time for various types and amounts of precooked food. All food should be precooked and at refrigerator temperature. To use sensor reheating:

- 1 Press **SENSOR REHEAT**. The display will show "REHEAT" and the oven will start automatically.



If you want to adjust the heating time, use the **MORE/LESS** button. See page 14.

If you want to check the current time while reheating, press the **CLOCK** button

Defrosting Automatically

To thaw frozen food, set the weight of the food and the microwave automatically sets the defrosting time, power level and standing time.

- 1 Press the **Auto Defrost** button. The display shows "0.5 LB." (0.2Kg if you have set your oven for metric measure).



- 2 To set the weight of your food, press the **Auto Defrost** button repeatedly. This increases the weight by 0.5 lb increments, up to 6.0 lbs.

You can also use the number buttons to enter the weight of the food directly.

The oven calculates the defrosting time and starts automatically. Twice during defrosting, the oven will beep and the display will show "TURN THE FOOD OVER."



Although you don't turn the food over, auto-defrosting is done by preset time.

- 3 Press the **Pause/Cancel** button, open the oven door, and turn the food over.
- 4 After closing the door. Press the **Start** button to resume defrosting.

- **See next page for the Auto Defrosting Guide**

Defrosting Guide

Follow the instructions below when defrosting different types of food.

Type of food: Roast beef, pork
 Amount: 1.2-2.5 kg
 Procedure: Start with the food placed fat side down. After each stage, turn the food over and shield any warm portions with narrow strips of aluminum foil.

Type of food: Steaks, chops, fish
 Amount: 0.2-1.2 kg
 Procedure: After each stage, rearrange the food. If there are any warm or thawed portions of food, shield them with narrow strips of aluminum foil. Remove any pieces of food that are nearly defrosted. Let stand, covered, for 5-10 minutes.

Type of food: Ground meat
 Amount: 0.2-1.2 kg
 Procedure: After each stage, remove any pieces of food that are nearly defrosted. Let stand, covered with foil, for 5-10 minutes.

Type of food: Chicken, whole
 Amount: 1.2-2.4 kg
 Procedure: Remove giblets before freezing poultry. Start defrosting with the breast side down. After the first stage, turn the chicken over and shield any warm portions with narrow strips of aluminum foil. After the second stage, again shield any warm portions with narrow strips of aluminum foil. When defrost cycle is over, let stand, covered, for 30-60 minutes in the refrigerator.

Type of food: Chicken, pieces
 Amount: 0.2-1.2 kg
 Procedure: After each stage, rearrange or remove any pieces of food that are nearly defrosted. Let stand for 10-20 minutes.

Notes

Check foods when the oven signals. After the final stage, small sections may still be icy; let them stand to continue thawing. Do not cook until all ice crystals have thawed.

Shielding roasts and steaks prevents the edges from cooking before the center of the food has defrosted. Use narrow, flat, smooth strips of aluminum foil to cover the edges and thinner sections of the food.

Setting Cooking Times & Power Levels

Your microwave allows you to set up to three different stages of cooking, each with its own time length and power level. The power level lets you control the heating intensity from Warm (1) to High (0).

One-stage Cooking

For simple one-stage cooking, you only need to set a cooking time. The power level is automatically set at High. If you want the power set at any other level, you must set it using the **Power Level** button.

- 1 Use the number buttons to set a cooking time. You can set a time from one second to 99 minutes, 99 seconds. To set a time over one minute, enter the seconds too. *For example, to set 20 minutes, enter 2, 0, 0, 0.*
- 2 If you want to set the power level to something other than High, press the **Power Level** button, then use the number buttons to enter a power level.

Power Levels:

1 = warm	6 = simmer
2 = low	7 = medium high
3 = defrost	8 = reheat
4 = medium low	9 = sauté
5 = medium	0 = high

The display shows "PRESS START OR ENTER NEXT STAGE COOKING TIME"

PRESS START OR ENTER NEXT STAGE COOKING TIME

- 3 Press the **Start** button to begin cooking. If you want to change the power level, press **Pause/Cancel** before you press **Start**, and reenter all of the instructions.

Setting Cooking Times, continued

Some recipes require different stages of cooking at different temperatures. You can set multiple stages of cooking with your microwave.

Multi-stage Cooking

- 1 Follow steps 1 and 2 in the "One-Stage Cooking" section on this page. The display shows "PRESS START OR ENTER NEXT STAGE COOKING TIME."

PRESS START OR ENTER NEXT STAGE COOKING TIME

*When entering more than one cooking stage, the **Power Level** button must be pressed before the second cooking stage can be entered.*

*To set the power level at High for a stage of cooking, press the **Power Level** button twice.*

- 2 Use the **Number** buttons to set a second cooking time.
- 3 Press the **Power Level** button, then use the number buttons to set the power level of the second stage of cooking. The display shows the power level you have set and then "PRESS START OR ENTER NEXT STAGE COOKING TIME."

PRESS START OR ENTER NEXT STAGE COOKING TIME

- 4 Press **Start** to begin cooking, or repeat steps 2 and 3 to set a cooking time and power level for a third stage of cooking. When finished, press **Start**.

Using the More/Less Button

The **More/Less** button allows you to adjust pre-set cooking times. It only works with the **Sensor Reheat**, and **Sensor-cooking** buttons. Use the **More/Less** button only after you have already begun cooking with one of these procedures. The **More/Less** key cannot be used with the **Baby Food** key.

- 1 To ADD more time to an automatic cooking procedure: Press the **More/Less** button once. The word "MORE" will appear in the display.



MORE

- 2 To REDUCE the time of an automatic cooking procedure: Press the **More/Less** button twice. The word "LESS" will appear in the display.



LESS

- 3 To return to the NORMAL time set for an automatic cooking procedure: Press the **More/Less** button until the word "NORMAL" appears in the display.



NORMAL

Adjusting the Volume

The **Sound** button on the microwave allows you to adjust the volume of the microwave's chime sound. The sound is initially set to its highest setting. To change the volume:

- 1 Press the **Sound** button. The display shows "0-OFF 1-LOW 2-MED 3-HIGH"

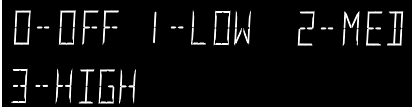

0-OFF 1-LOW 2-MED
3-HIGH

- 2 Press "0" to turn the volume off, "1" for low volume, "2" for medium volume, or "3" for high volume.

The display will show the volume you have chosen, then shows "PRESS START"



PRESS START

- 3 Press **Start**

Using the Kitchen Timer

- 1 Use the **Number** buttons to set the length of time you want the timer to run.
- 2 Press the **Kitchen Timer** button.
- 3 The display counts down and the oven beeps when the time has elapsed.

Setting the Child Protection Lock

You can lock your microwave oven so it can't be used by unsupervised children.

- 1 Press the **"0"** button. The display shows "PRESS 1-DEMO 2- CHILD LOCK."

- 2 Press the **"2"** button. The display shows "PRESS START."

- 3 Press the **Start** button. The display shows "LOCK" then returns to the time of day.

At this point, the microwave oven cannot be used until it is unlocked. To unlock it, repeat steps 1–3 above.

Demonstration Mode

You can use the Demonstration Mode to see how your microwave oven operates without the oven heating.

- 1 Press the **"0"** button. The display shows "PRESS 1-DEMO 2- CHILD LOCK."

- 2 Press the **"1"** button. The display shows "PRESS START".

- 3 Press the **Start** button. The display shows "DEMO MODE ON".

To turn demo mode off, repeat steps 1–3 above.

NOTE ; Do not use Demonstration Mode for sensor cooking. E1 error will be displayed when you use the demo mode for sensor cook pads except pop-corn, baby food.

Cooking Utensils

Recommended Use

- **Glass and glass-ceramic bowls and dishes** — Use for heating or cooking.
- **Microwave browning dish** — Use to brown the exterior of small items such as steaks, chops, or pancakes. Follow the directions provided with your browning dish.
- **Microwavable plastic wrap** — Use to retain steam. Leave a small opening for some steam to escape and avoid placing it directly on the food.
- **Wax paper** — Use as a cover to prevent spattering.
- **Paper towels and napkins** — Use for short-term heating and covering; they absorb excess moisture and prevent spattering. Do not use recycled paper towels, which may contain metal and can catch fire.
- **Paper plates and cups** — Use for short-term heating at low temperatures. Do not use recycled paper, which may contain metal and can catch fire.
- **Thermometers** — Use only those labeled “Microwave Safe” and follow all directions. Check the food in several places. Conventional thermometers may be used once the food has been removed from the oven.

Limited Use

- **Aluminum foil** — Use narrow strips of foil to prevent overcooking of exposed areas. Using too much foil can damage your oven, so be careful.
- **Ceramic, porcelain, and stoneware** — Use these if they are labeled “Microwave Safe.” If they are not labeled, test them to make sure they can be used safely. Never use dishes with metallic trim.
- **Plastic** — Use only if labeled “Microwave Safe.” Other plastics can melt.
- **Straw, wicker, and wood** — Use only for short-term heating, as they can be flammable.

Not Recommended

- **Glass jars and bottles** — Regular glass is too thin to be used in a microwave, and can shatter.
- **Paper bags** — These are a fire hazard, except for popcorn bags that are designed for microwave use.
- **Styrofoam plates and cups** — These can melt and leave an unhealthy residue on food.
- **Plastic storage and food containers** — Containers such as margarine tubs can melt in the microwave.
- **Metal utensils** — These can damage your oven. Remove all metal before cooking.

Testing Utensils

If you are not sure whether a dish is microwave-safe or not, you can perform this test:

- 1 Fill a 1 cup glass measuring cup with water and put it inside your oven, next to the dish you want to test.

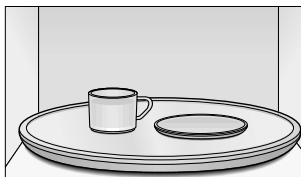

- 2 Press the **One Minute+** button once to heat them for one minute at High power.

The water should be warm and the dish you are testing should be cool. If the dish is warm, then it is absorbing microwave energy and is not acceptable for use in the microwave.

Cooking Techniques

Stirring

Stir foods such as casseroles and vegetables while cooking to distribute heat evenly. Food at the outside of the dish absorbs more energy and heats more quickly, so stir from the outside to the center. The oven will turn off when you open the door to stir your food.

Arrangement

Arrange unevenly shaped foods, such as chicken pieces or chops, with the thicker, meatier parts toward the outside of the turntable where they receive more microwave energy. To prevent overcooking, place thin or delicate parts toward the center of the turntable.

Shielding

Shield food with narrow strips of aluminum foil to prevent overcooking. Areas that need shielding include poultry wing-tips, the ends of poultry legs, and corners of square baking dishes. Use only small amounts of aluminum foil. Larger amounts can damage your oven.

Turning

Turn foods over midway through cooking to expose all parts to microwave energy. This is especially important with large items such as roasts.

Standing

Foods cooked in the microwave build up internal heat and continue to cook for a few minutes after the oven stops. Let foods stand to complete cooking, especially foods such as roasts and whole vegetables. Roasts need this time to complete cooking in the center without overcooking the outer areas. All liquids, such as soup or hot chocolate, should be shaken or stirred when cooking is complete. Let liquids stand a moment before serving. When heating baby food, stir well and test the temperature before serving.

Adding Moisture

Microwave energy is attracted to water molecules. Food that is uneven in moisture content should be covered or allowed to stand so that the heat disperses evenly. Add a small amount of water to dry food to help it cook.

General Tips

- Dense foods, such as potatoes, take longer to heat than lighter foods. Foods with a delicate texture should be heated at a low power level to avoid becoming tough.
- Altitude and the type of cookware you are using can affect cooking time. When using a new recipe, use the minimum cooking time and check the food occasionally to prevent overcooking.
- Foods with a non-porous skin or shell, such as potatoes, eggs, or hot dogs, should be pierced to prevent bursting.
- Frying with heating oil or fat is not recommended. Fat and oil can suddenly boil over and cause severe burns.
- Some ingredients heat faster than others. For example, the jelly inside a jelly doughnut will be hotter than the dough. Keep this in mind to avoid burns.
- Home canning in the microwave oven is not recommended because all harmful bacteria may not be destroyed by the microwave heating process.
- Although microwaves do not heat the cookware, the heat is often transferred to the cookware. Always use pot holders when removing food from the microwave and instruct children to do the same.

Auto Sensor Cook

The Auto Sensor allows you to cook your food automatically by detecting the amount of gases generated from the food while cooking.

- When cooking food, many kinds of gases are generated. The Auto Sensor determines the proper time and power level by detecting these gases from the food, eliminating the need to set the cooking time and power level.
- When you cover a container with its lid or plastic wrap during Sensor Cooking, the Auto Sensor will detect the gases generated after the container has been saturated with steam.
- Shortly before cooking ends, the remaining cooking time will begin its count down. This will be a good time for you to rotate or stir the food for even cooking if it is necessary.
- Before auto sensor cooking food may be seasoned with herbs, spices or browning sauces. A word of caution though, salt or sugar may cause burn spots on food so these ingredients should be added after cooking.
- The MORE/LESS function pad is used to increase or decrease cooking time. You should use this function to adjust the degree of cooking to suit your personal taste.

Utensils & Cover For Sensor Cooking

- To obtain good cooking results with this function, follow the directions for selecting appropriate containers and covers in the charts in this book.
- Always use microwave-safe containers and cover them with their lids or with plastic wrap. When using plastic wrap, turn back one corner to allow steam to escape at the proper rate.
- Always cover with the lid intended for the utensil being used. If the utensil does not have its own lid, use plastic wrap.
- Fill containers at least half full.
- Foods that require stirring or rotating should be stirred or turned toward the end of the Sensor Cook cycle, after the time has started to count down on the display.

Important

- After installing the oven and plugging into an electrical outlet, do not unplug the power cord. The gas sensor needs time to stabilize in order to cook satisfactorily.
- If its not advisable to use the auto sensor cooking feature on a continuous cooking operation, i.e. one cooking operation immediately after another.
- Install the oven in a well ventilated location for proper cooling and airflow and to ensure the sensor will operate accurately.
- To avoid poor results, do not use the Auto sensor when the room ambient temperature is too high or too low.
- Do not use volatile detergent to clean your oven. Gas resulting from this detergent may affect the sensor.
- Avoid placing the oven near high moisture or gas emitting appliances, since this will interfere with the proper performance of the Auto Sensor.
- Always keep the inside of the oven clean. Wipe all spills with a damp cloth.

This oven is designed for household use only.

COOKING INSTRUCTIONS

GUIDE for Cooking Meat in Your Microwave

- Place meat on a microwave-safe roasting rack in a microwave-safe dish.
- Start meat fat-side down. Use narrow strips of aluminum foil to shield any bone tips or thin meat areas.
- Check the temperature in several places before letting the meat stand the recommended time.
- The following temperatures are removal temperatures. The temperature of the food will rise during the standing time.

Food	Cook Time /Power Level	Directions
Roast Beef Boneless Up to 1.8 kg	<i>Cooking Time:</i> 15-20 min. / kg for 46° C - Rare 17-27 min. / kg for 49° C - Medium 19-31 min. / kg for 63° C - Well Done <i>Power Level:</i> High(0) for first 5 min., then Medium(5).	Place roast fat-side down on roasting rack. Cover with wax paper. Turn over when cooking time is half up. Let stand 10 min.
Pork Boneless or bone-in Up to 1.8 kg	<i>Cooking Time:</i> 22-23 min. / kg for 71° C Well Done <i>Power Level:</i> High(0) for first 5 min., then Medium(5).	Place roast fat-side down on roasting rack. Cover with vented plastic wrap. Turn over when cooking time is half up. Let stand 10 min.
Bacon 2-6 slices	<i>Cooking Time:</i> 2 slices: 1- 13/4 min. 4 slices: 3- 31/2 min. 6 slices: 4 1/2-5 1/2 min. <i>Power Level:</i> High(0).	Arrange slices on roasting rack or a dish lined with paper-towel. Cover with paper towel. Microwave until crisp.

GUIDE for Cooking Poultry in Your Microwave

- Place poultry on a microwave-safe roasting rack in a microwave-safe dish.
- Cover poultry with wax paper to prevent spattering.
- Use aluminum foil to shield bone tips, thin meat areas, or areas that start to overcook.
- Check the temperature in several places before letting the poultry stand the recommended time.

Food	Cook Time /Power Level	Directions
Whole Chicken Up to 1.8 kg	<i>Cooking Time:</i> 13-20 min. / kg 76° -82°C <i>Power Level:</i> Medium High(7).	Place chicken breast-side down on roasting rack. Cover with wax paper. Turn over when the cooking time is half up. Cook until juices run clear and meat near the bone is no longer pink. Let stand 5-10 min.
Chicken Pieces Up to 1.0 kg	<i>Cooking Time:</i> 13-20 min. / kg 76° C dark meat 82° C light meat <i>Power Level:</i> Medium High(7).	Place chicken bone-side down on dish, with the thickest portions towards the outside of the dish. Cover with wax paper. Turn over when the cooking time is half up. Cook until juices run clear and meat near the bone is no longer pink. Let stand 5-10 min.

GUIDE for Cooking Seafood in Your Microwave

- Cook fish until it flakes easily with a fork.
- Place fish on a microwave-safe roasting rack in a microwave-safe dish.
- Use a tight cover to steam fish. A lighter cover of wax paper or paper towel provides less steaming.
- Do not overcook fish; check it at minimum cooking time.

Food	Cook Time /Power Level	Directions
Steaks Up to 700 g	<i>Cooking Time:</i> 13-22 min. / kg <i>Power Level:</i> Medium High(7).	Arrange steaks on roasting rack with meaty portions towards the outside of rack. Cover with wax paper. Turn over and rearrange when cooking time is half up. Cook until fish flakes easily with a fork. Let stand 3-5 min.
Fillets Up to 700 g	<i>Cooking Time:</i> 6-16 min. / kg <i>Power Level:</i> Medium High(7).	Arrange fillets in a baking dish, turning any thin pieces under. Cover with wax paper. If over 1/2 inch thick, turn over and rearrange when cooking time is half up. Cook until fish flakes easily with a fork. Let stand 2-3 min.
Shrimp Up to 700 g	<i>Cooking Time:</i> 6-12 min. / kg <i>Power Level:</i> Medium High(7).	Arrange shrimp in a baking dish without overlapping or layering. Cover with wax paper. Cook until firm and opaque, stirring 2 or 3 times. Let stand 5 min.

GUIDE for Cooking Eggs in Your Microwave

- Never cook eggs in the shell, and never warm hard-cooked eggs in the shell; they can explode.
- Always pierce whole eggs to keep them from bursting.
- Cook eggs just until set; they become tough if overcooked.

GUIDE for Cooking Vegetables in Your Microwave

- Vegetables should be washed just before cooking. Often, no extra water is needed. If dense vegetables such as potatoes, carrots and green beans are being cooked, add about 1/4 cup water.
- Small vegetables (sliced carrots, peas, lima beans, etc.) will cook faster than larger ones.
- Whole vegetables, such as potatoes, acorn squash or corn on the cob, should be arranged in a circle on the turntable before cooking. They will cook more evenly if turned over after half the cooking time.
- Always place vegetables like asparagus and broccoli with the stem ends pointing towards the edge of the dish and the tips toward the center.
- When cooking cut vegetables, always cover the dish with a lid or vented microwavable plastic wrap.
- Whole, unpeeled vegetables such as potatoes, squash, eggplant, etc., should have their skin pricked in several spots before cooking to prevent them from bursting.
- For more even cooking, stir or rearrange whole vegetables halfway through the cooking time.
- Generally, the denser the food, the longer the standing time. (Standing time refers to the time necessary for dense, large foods and vegetables to finish cooking after they come out of the oven.) A baked potato can stand on the counter for five minutes before cooking is completed, while a dish of peas can be served immediately.

SENSOR COOKING GUIDE

- Follow the instructions below when sensor cooking different types of food.

Food	Amount	Procedure
Popcorn	<i>1 package (100-115 g)</i>	Use one microwave-only bag of popcorn. Pop only one bag at a time. Use caution when removing and opening hot bag from oven.
Frozen Vegetable	<i>1 to 4 cups</i>	Remove from package. Place the vegetables into a casserole and add a small amount of water (2-4 Tbsp). Cover during cooking and stir before standing. Let vegetables stand 3 minutes before serving. Let oven cool for at least 5 minutes before using again.
Potato	<i>1 to 6 EA.</i>	Prick each potato several times with fork. Place on turntable in spoke-like fashion. Let stand 3 -5 min. Let oven cool for at least 5 minutes before using again.
Fresh Vegetable	<i>1 to 4 cups</i>	Arrange fresh vegetables in microwave-safe ceramic, glass or plastic dish and combine with 2 Tbs. water. For even cooking, stir or turn vegetables according to instructions. Let vegetables stand 3 minutes before serving. Let oven cool for at least 5 minutes before using again.
Frozen Dinner	<i>200-500 g</i>	Remove packing from outer wrapping and follow box instructions for covering and standing. Let oven cool for at least 5 minutes before using again.

COOKING INSTRUCTIONS

SENSOR COOKING GUIDE(Continued)

Food	Amount	Procedure
Rice	<i>100-300 g rice 300-500 ml water</i>	Put rice and water in 2 to 3 qt. round glass casserole. Cover and place casserole in center of glass tray. To get best result, use the microwave-safe rice cooker. After cooking, let stand 5-10 min..
Baby Food	<i>100-200 g</i>	Remove lid from baby food and heat(heating time is very short). Check temperature and stir well before serving. The More/Less key cannot be used with the baby food key.
Fish	<i>250-750 g</i>	Arrange fish in dish with thickest portions to the outside. Overlap thin areas in center of dish. Turn thin ends under. Cover with vented plastic wrap. Let oven cool for at least 5 minutes before using again.

SENSOR REHEAT GUIDE

- Follow the instructions below when sensor reheating different types of food.

Plate of food	<i>1 serving (1 plate)</i>	Use only pre-cooked, refrigerated foods. Cover plate with vented plastic wrap or wax paper. If food is not as hot as you prefer after heating with SENSOR REHEAT, continue heating using time and power. <ul style="list-style-type: none"> • Contents <ul style="list-style-type: none"> - 85-110 g meat, poultry or fish(up to 170 g with bone) - 1/2 cup starch (potatoes, pasta, rice, etc.) - 1/2 cup vegetables (about 85-110 g)
Casseroles Soups/Sauces	<i>1 to 4 servings</i>	Use only refrigerated foods. Cover plate with lid or vented plastic wrap. If food is not as hot as you prefer after heating with SENSOR REHEAT, continue heating using time and power. Stir foods once before serving.

Recipes

French Onion Soup (4 servings)

- 3 tablespoons butter or margarine
- 3 cups (about 3 medium) sliced onions
- 3 cups beef broth
- 1 cup water
- 1 teaspoon Worcestershire sauce
- Salt, pepper, croutons, grated parmesan cheese to taste
- 2 tablespoons brandy (optional)

- 1 Combine butter and onions in 3-quart casserole. Cover with lid. Microwave at HIGH (0) for 8 to 9 minutes or use Sensor Fresh Vegetable.
- 2 Stir in broth, water, Worcestershire sauce, salt and pepper ; cover. Microwave at HIGH (0) for 5 minutes, and at MEDIUM (5) for 5 minutes or use Sensor Reheat. Stir in brandy. Let stand, covered, for 5 minutes before serving. Serve with croutons and cheese.

Snap Crackle Popcorn Balls (10 to 15 balls)

- 30 square caramel candies
- 1 1/2 tablespoons water
- 1 teaspoon butter or margarine
- 1 pkg.(115 g) microwave popcorn

- 1 Combine caramel, water and butter in 4 cup glass bowl. Microwave at HIGH (0) for 2 to 3 minutes until melted. Stir until smooth. Set aside.
- 2 Place popcorn on turntable. Microwave at HIGH (0) for 2 to 3 minutes or use Sensor Popcorn.
- 3 Place popcorn in bowl. Pour caramel mixture over popcorn ; toss until completely coated and cool enough to handle. Using buttered hands, form into 3-inch balls.
- 4 Cool on waxed paper. Serve immediately.

Peas With Lettuce (4 servings)

- 2 cups fresh shelled green peas
- 1/3 cup thinly sliced celery
- 2 tablespoons water
- 3 cups shredded head lettuce
- 1 tablespoon butter or margarine
- 1 tablespoon all-purpose flour
- 1/2 teaspoon sugar
- 1/4 teaspoon salt
- 1/4 cup whipping cream
- Dash pepper to taste

- 1 In 1 1/2 -quart casserole combine peas, celery and water ; cover. Microwave at HIGH (0) for 5 to 7 1/2 minutes or use Sensor Fresh Vegetable. Stir in lettuce ; re-cover.
- 2 In small dish combine butter, flour, sugar, salt and pepper. Blend in cream. Microwave at HIGH (0) for 1 to 2 minutes or use Sensor Reheat. Stir until smooth.
- 3 Drain vegetables. Add sauce to vegetables ; toss to coat.

Stuffed Potatoes (4 servings)

- 4 medium potatoes, scrubbed
- 1/2 cup dairy sour cream
- 1/3 cup milk
- 2 tablespoons grated parmesan cheese
- 1 teaspoon chopped chives or parsley flakes
- Salt, pepper, paprika to taste

- 1 Prick potatoes twice with a fork. Arrange potatoes at least 1 inch apart on paper towel placed on turntable. Microwave at HIGH (0) for 10 to 12 minutes or use Sensor Potato. Let stand 5 minutes.
- 2 Slice top from each potato ; scoop out center. Mash with sour cream, milk, cheese, chives, salt and pepper. Spoon into shells.
- 3 Sprinkle with paprika. Place on plate or on paper towel in oven. Microwave at HIGH (0) for 2 to 4 minutes or use Sensor Reheat.

COOKING INSTRUCTIONS

Vegetable Medley (4 to 6 servings)

1 1/2 cups broccoli flowerets, 3/4 to 1 inch in diameter

1 1/2 cups cauliflower flowerets, 3/4 to 1 inch in diameter

1 medium yellow squash, cut into 1/4 inch diagonal slices

1 medium zucchini, cut into 1/4 inch diagonal slices

1 medium carrot, cut into 1/8 inch diagonal slices

1/2 small red pepper, slivered

6-7 pitted ripe olives, sliced

2-3 tablespoons butter or margarine

1/2 teaspoon dried oregano

1 teaspoon fresh lemon juice

parmesan cheese, optional to taste

- 1 Arrange broccoli and cauliflower alternately around the edge of a 10 to 12 inch glass dish with rim. Alternately place yellow squash and zucchini in circle inside broccoli and cauliflower, place carrots slices in center and arrange red pepper slivers over top. Sprinkle with 2 tablespoons water. Cover with vented microwave plastic wrap.
- 2 Microwave at HIGH (0) for 7 to 9 minutes or use Sensor Fresh Vegetable. Remove wrap immediately, scatter olive slices attractively over all.
- 3 Place butter or margarine in 1 cup glass measure and Microwave at HIGH (0) for 30 seconds to 1 minute to melt. Add oregano and lemon juice. Pour over vegetables. Sprinkle with parmesan cheese and serve.

Franks And Beans Casserole (4 to 6 servings)

1/2 cup chopped onions

2 tablespoons butter or margarine

1 pkg.(340-450 g) frankfurters, cut in quarters

1 can (450 g) baked beans

1 can (420-450 g) cannellini (white kidney) beans,drained

1 can (420-450 g) red kidney beans,drained

1/3 cup brown sugar

1/4 cup catsup

1 teaspoon yellow mustard

Salt, pepper and garlic powder to taste

- 1 Combine onions and butter in 3-quart casserole. Microwave at HIGH(0) for 1 to 2 minutes or until onions are soft.
- 2 Stir in all remaining ingredients, pushing frankfurters to the bottom of dish so they are covered with the beans.
- 3 Cover and microwave at HIGH (0) for 11 to 13 minutes or use Sensor Reheat. Stir until smooth.

Troubleshooting Guide

Before you call a repair person for your oven, check this list of possible problems and solutions.

Neither the oven's display nor the oven operate.

- Properly insert the plug into a grounded outlet.
- If the outlet is controlled by a wall switch, make sure the wall switch is turned on.
- Remove the plug from the outlet, wait ten seconds, then plug it in again.
- Reset the circuit breaker or replace any blown fuse.
- Plug another appliance into the outlet; if the other appliance doesn't work, have a qualified electrician repair the outlet.
- Plug the oven into a different outlet.

The oven's display works, but the power won't come on.

- Make sure the door is closed securely.
- Check to see if packing material or other material is stuck to the door seal.
- Check for door damage.
- Press Cancel twice and re-enter all cooking instructions.

The power goes off before the set time has elapsed.

- If there has not been a power outage, remove the plug from the outlet, wait ten seconds, then plug it in again. If there was a power outage, the time indicator will display "SAMSUNG SO SIMPLE" Reset the clock and any cooking instructions.
- Reset the circuit breaker or replace any blown fuse.

You see sparks or arcing.

- Remove any metallic utensils, cookware, or metal ties. If using foil, use only narrow strips and allow at least one inch between the foil and interior oven walls.

The turntable makes noises or sticks.

- Clean the turntable, roller ring and oven floor.
- Make sure the turntable and roller ring are positioned correctly.

Using your microwave causes TV or radio interference.

- This is similar to the interference caused by other small appliances, such as hair dryers. Move your microwave further away from other appliances, like your TV or radio.

Care and Cleaning

Follow these instructions to clean and care for your oven.

- Keep the inside of the oven clean. Food particles and spilled liquids can stick to the oven walls, causing the oven to work less efficiently.
- Wipe up spills immediately. Use a damp cloth and mild soap. Do not use harsh detergents or abrasives.
- To help loosen baked on food particles or liquids, heat two cups of water (add the juice of one lemon if you desire to keep the oven fresh) in a four-cup measuring glass at High power for five minutes or until boiling. Let stand in the oven for one or two minutes.
- Remove the glass tray from the oven when cleaning the oven or tray. To prevent the tray from breaking, handle it carefully and do not put it in water immediately after cooking. Wash the tray carefully in warm sudsy water or in the dishwasher.
- Clean the outside surface of the oven with soap and a damp cloth. Dry with a soft cloth. To prevent damage to the operating parts of the oven, don't let water seep into the openings.
- Wash the door window with very mild soap and water. Be sure to use a soft cloth to avoid scratching.
- If steam accumulates inside or outside the oven door, wipe with a soft cloth. Steam can accumulate when operating the oven in high humidity and in no way indicates microwave leakage.
- Never operate the oven without food in it; this can damage the magnetron tube or glass tray. You may wish to leave a cup of water in the oven when it is not in use to prevent damage if the oven is accidentally turned on.

**If you have a problem you cannot solve,
Contact your local dealer or SAMSUNG
after-sales service.**

Technical Specifications

Model	M198SCE	M1D8SCE
Power Source	240 V ~ 50 Hz	240 V ~ 50 Hz
Power Consumption Microwave	1450 W	1450 W
Outer Power	100 W / 1000 W (IEC-705)	100 W / 1000 W (IEC-705)
Operating Frequency	2450 MHz	2450 MHz
Magnetron	OM75P(31)	OM75P(31)
Cooling Method	Cooling Fan Motor	Cooling Fan Motor
Dimensions (W x H x D)		
Outside	517 x 297 x 379 mm	556 x 313 x 423 mm
Oven Cavity	336 x 241 x 349 mm	375 x 251 x 392 mm
Volume	28 Liter	37 Liter
Weight		
Net	16 kg approx	18.5 kg approx



Free Manuals Download Website

<http://myh66.com>

<http://usermanuals.us>

<http://www.somanuals.com>

<http://www.4manuals.cc>

<http://www.manual-lib.com>

<http://www.404manual.com>

<http://www.luxmanual.com>

<http://aubethermostatmanual.com>

Golf course search by state

<http://golfingnear.com>

Email search by domain

<http://emailbydomain.com>

Auto manuals search

<http://auto.somanuals.com>

TV manuals search

<http://tv.somanuals.com>