

# Microwave Oven

---

User manual

MC12J8035CT

---



**SAMSUNG**

# Contents

---

<b>Important safety instructions</b>	<b>3</b>
<hr/>	
<b>Installation</b>	<b>11</b>
<hr/>	
What's included	11
Accessories	11
Turntable	12
<hr/>	
<b>Maintenance</b>	<b>12</b>
<hr/>	
Cleaning	12
Replacement (repair)	13
Care during an extended period of disuse	13
<hr/>	
<b>Before you start</b>	<b>13</b>
<hr/>	
Clock	13
Sound On/Off	14
About microwave energy	14
Cookware for microwave mode	15
<hr/>	
<b>Operations</b>	<b>16</b>
<hr/>	
Control panel	16
Manual mode	17
Auto mode	21
Special functions	23
<hr/>	
<b>Cooking Smart</b>	<b>24</b>
<hr/>	
Auto cooking	24
Manual cooking	28
Quick & Easy	36

---

<b>Troubleshooting</b>	<b>37</b>
<hr/>	
Checkpoints	37
Information codes	40
<hr/>	
<b>Technical specifications</b>	<b>40</b>
<hr/>	
<b>Warranty</b>	<b>41</b>
<hr/>	

## Important safety instructions

Congratulations on your new Samsung microwave oven. This manual contains important information on the installation, use and care of your appliance. Please take time to read this manual to take full advantage of your microwave oven's many benefits and features.

## WHAT YOU NEED TO KNOW ABOUT SAFETY INSTRUCTIONS

Warnings and Important Safety Instructions in this manual do not cover all possible conditions and situations that may occur. It is your responsibility to use common sense, caution, and care when installing, maintaining, and operating your microwave oven.

## PRECAUTIONS TO AVOID POSSIBLE EXPOSURE TO EXCESSIVE MICROWAVE ENERGY

- A. Do not attempt to operate this oven with the door open since open-door operation can result in harmful exposure to microwave energy. It is important not to defeat or tamper with the safety interlocks.
- B. Do not place any object between the oven front face and the door or allow soil or cleaner residue to accumulate on the sealing surface.
- C. Do not operate the oven if it is damaged. It is particularly important that the oven door close properly and that there is no damage to the:
  - 1) Door (bent),
  - 2) Hinges and latches, (broken or loosened),
  - 3) Door seals and sealing surface.
- D. The oven should not be adjusted or repaired by anyone except properly qualified service personnel.

## IMPORTANT SAFETY SYMBOLS AND PRECAUTIONS

What the icons and signs in this user manual mean:

### WARNING

Hazards or unsafe practices that may result in **severe personal injury or death**.

### CAUTION

Hazards or unsafe practices that may result in **minor personal injury or property damage**.

### CAUTION

To reduce the risk of fire, explosion, electric shock, or personal injury when using your microwave oven, follow these basic safety precautions.



Do NOT attempt.



Do NOT disassemble.



Do NOT touch.



Follow directions explicitly.



Unplug the power plug from the wall socket.



Make sure the machine is grounded to prevent electric shock.



Call the service center for help.



Note

**These warning signs are here to prevent injury to you and others. Please follow them explicitly. After reading this section, keep it in a safe place for future reference.**

## SAVE THESE INSTRUCTIONS

## Important safety instructions

# STATE OF CALIFORNIA PROPOSITION 65 WARNING (US ONLY)

WARNING : This product contains chemicals known to the State of California to cause cancer and birth defects or other reproductive harm.

When using any electrical appliance, basic safety precautions should be followed, including the following:

## WARNING

To reduce risk of burns, electric shock, fire, personal injury or exposure to excessive microwave energy:

1. Read all safety instructions before using the appliance.
2. Read and follow the specific "Precautions to avoid possible exposure to excessive microwave energy" on page 3.
3. This appliance must be grounded. Connect only to properly grounded outlets. See Important "Grounding instructions" on page 7 of this manual.
4. Install or locate this appliance only in accordance with the provided installation instructions.
5. Some products such as whole eggs and sealed containers (for example, closed glass jars) can explode if heated rapidly. Never heat them in a microwave oven.
6. Use this appliance only for its intended use as described in the manual. Do not put corrosive chemicals or vapors in or on this appliance. This type of oven is specifically designed to heat, cook, or dry food. It is not designed for industrial or laboratory use.
7. As with any appliance, close supervision is necessary when it is used by children. Keep children away from the door when opening or closing it as they may bump themselves on the door or catch their fingers in the door.
8. Do not operate this appliance if it has a damaged cord or plug, if it is not working properly, or if it has been damaged or dropped.

## SAVE THESE INSTRUCTIONS

9. This appliance should be repaired or serviced only by qualified service personnel. Contact the nearest authorized service facility for examination, repair, or adjustment.
10. Do not cover or block any openings on the appliance.
11. Do not tamper with or make any adjustments or repairs to the door.
12. Do not store this appliance outdoors. Do not use this product near water, for example, near a kitchen sink, in a wet basement, near a swimming pool, or similar locations.
13. Do not immerse the cord or plug in water.
14. Keep the cord away from heated surfaces. (including the back of the oven).
15. Do not let the cord hang over edge of table or counter.
16. When cleaning surfaces of the door and oven that come together when the door closes, use only mild, nonabrasive soaps, or detergents applied with a sponge or soft cloth. Unplug the plug before cleaning.
17. To reduce the risk of fire in the oven cavity:
18. Do not overcook food. Carefully attend appliance when paper, plastic, or other combustible materials are placed inside the oven to facilitate cooking.
19. Remove wire twist-ties from paper or plastic bags before placing the bags in the oven.
20. If materials inside the oven ignite, keep the oven door closed, turn the oven off, and disconnect the power cord, or shut off the power at the fuse or circuit breaker panel. If the door is opened, the fire may spread.
21. Do not use the cavity for storage purposes. Do not leave paper products, cooking utensils, or food in the cavity when not in use.
22. Liquids, such as water, milk, coffee, or tea can be overheated beyond the boiling point without appearing to be boiling. Visible bubbling or boiling when the container is removed from the microwave oven is not always present. THIS COULD RESULT IN VERY HOT LIQUIDS SUDDENLY BOILING OVER WHEN THE CONTAINER IS DISTURBED OR A SPOON OR OTHER UTENSIL IS INSERTED INTO THE LIQUID. To reduce the risk of injury:
23. Do not overheat liquid.
24. Stir liquid both before and halfway through heating it.
25. Do not use straight-sided containers with narrow necks.

26. After heating, allow the container to stand in the microwave oven for a short time before removing the container.
27. Use extreme care when inserting a spoon or other utensil into the container.
28. Oversized foods or oversized metal utensils should not be inserted in microwave / toaster oven as they may create a fire or electric shock.
29. Do not clean with metal scouring pads. Pieces can burn off the pad and touch electrical parts involving a risk of electric shock.
30. Do not use paper products when appliance is operated in the toaster mode.
31. Do not store any materials, other than manufacturer's recommended accessories, in this oven when not in use.
32. Do not cover racks or any other part of the oven with metal foil. This will cause overheating of the oven.

## CAUTION

1. Over the range model only
  - Clean ventilating hoods frequently - Grease should not be allowed to accumulate on the hood of the filter.
  - When flaming foods under the hood, turn the fan on.
  - Use care when cleaning the vent-hood filter. Corrosive cleaning agents, such as lye-based oven cleaner, may damage the filter.
2. Push button type model only
  - Pre-caution for safe use to avoid possible exposure to excessive microwave energy : Do not attempt to pull any part of the door by hand to open the door. Open the door only utilizing the push button located at front-right-bottom side.

## GROUNDING INSTRUCTIONS

This appliance must be grounded. In the event of an electrical short circuit, grounding reduces the risk of electric shock by providing an escape wire for the electrical current. This appliance is equipped with a cord that includes a grounding wire and a grounding plug. The plug must be plugged into an outlet that is properly installed and grounded.

## WARNING

Improper use of the grounding plug can result in a risk of electric shock.

- Plug into a grounded 3 prong outlet. Do not remove the third (grounding) prong. Do not use an adaptor or otherwise defeat the grounding plug.
- Consult a qualified electrician or service person if you do not understand the grounding instructions or if you are not sure if the appliance is properly grounded.
- We do not recommend using an extension cord with this appliance. If the power-supply cord is too short, have a qualified electrician or serviceman install an outlet near the appliance. However, if it is necessary to use an extension cord, read and follow the "Use of Extension Cords" section below.

## USE OF EXTENSION CORDS

A short power-supply cord is provided to reduce the risk of your becoming entangled in or tripping over a longer cord. Longer cord sets or extension cords are available and you can use them if you exercise care. If you use a long cord or extension cord:



1. The marked electrical rating of the cord set or extension cord should be at least as great as the electrical rating of the appliance.
2. The extension cord must be a grounding-type 3-wire cord and it must be plugged into a 3-slot outlet.
3. The longer cord should be arranged so that it will not drape over the counter top or tabletop where it can be pulled on by children or tripped over accidentally. If you use an extension cord, the interior light may flicker and the speed of the blower may vary when the microwave oven is on. Cooking times may be longer too.

## SAVE THESE INSTRUCTIONS

## Important safety instructions



### **CRITICAL INSTALLATION WARNINGS**

-  The installation of this appliance must be performed by a qualified technician or service company.
  - Failing to have a qualified technician install the oven may result in electric shock, fire, an explosion, problems with the product, or injury. Unpack the oven, remove all packaging material and examine the oven for any damage such as dents on the interior or exterior of the oven, broken door latches, cracks in the door, or a door that is not lined up correctly. If there is any damage, do not operate the oven and notify your dealer immediately.
- Make sure to install your oven in a location with adequate space. Remove all foreign substances such as dust or water from the power plug terminals and contact points using a dry cloth on a regular basis.
  - Unplug the power plug and clean it with a dry cloth.
  - Failing to do so may result in electric shock or fire.
- Plug the power cord into a properly grounded 3 pronged outlet. Your oven should be the only appliance connected to this circuit.
  - Sharing a wall socket with other appliances, using a power strip, or extending the power cord may result in electric shock or fire.
  - Do not use an electric transformer. It may result in electric shock or fire.
  - Ensure that the voltage, frequency and current provided match the product's specifications. Failing to do so may result in electric shock or fire.
- Keep all packaging materials out of the reach of children. Children may use them for play.

-  This appliance must be properly grounded. Read and follow the specific "Grounding instructions" found in the beginning of this Section. Do not ground the appliance to a gas pipe, plastic water pipe, or telephone line.
  - This may result in electric shock, fire, an explosion, or problems with the product.
  - Never plug the power cord into a socket that is not grounded correctly and make sure that it is grounded in accordance with local and national codes.
- Do not cut or remove the third (ground) prong from the power cord under any circumstances. Connect the oven to a 20A circuit. If you connect the oven to a 15A circuit, make sure that the circuit breaker is operable.
-  Do not install this appliance in a humid, oily, or dusty location, or in a location exposed to direct sunlight or water (rain drops).
  - This may result in electric shock or fire.
- Plug the power plug into the wall socket firmly. Do not use a damaged power plug, damaged power cord, or loose wall socket.
  - This may result in electric shock or fire.
- Do not mount over a sink.
- Do not pull or excessively bend the power cord.
- Do not twist or tie the power cord.
- Do not hook the power cord over a metal object, place a heavy object on the power cord, insert the power cord between objects, or push the power cord into the space behind the appliance.
  - This may result in electric shock or fire.
- Do not pull the power cord when you unplug the oven.
  - Unplug the oven by pulling the plug only.
  - Failing to do so may result in electric shock or fire.
-  When the power plug or power cord is damaged, contact your nearest service center for a replacement or repair.

## SAVE THESE INSTRUCTIONS

## INSTALLATION CAUTIONS

-  Position the oven so that the plug is easily accessible.
  - Failing to do so may result in electric shock or fire due to electric leakage.
-  Unplug the oven when it is not being used for long periods of time or during a thunder/lightning storm.
  - Failing to do so may result in electric shock or fire.

## CRITICAL USAGE WARNINGS

-  If the microwave appliance is flooded, please contact your nearest service center. Failing to do so may result in electric shock or fire. Read and follow the specific “Precautions to Avoid Possible Exposure to Excessive Microwave Energy”, found in the beginning of this Safety Information Section.
 

If the microwave generates a strange noise, a burning smell or smoke, unplug it immediately and contact your nearest service center.

  - Failing to do so may result in electric shock or fire.

In the event of a gas leak (propane gas, LP gas, etc.), ventilate the room immediately. Do not touch the microwave, power cord, or plug.

  - Do not use a ventilating fan.
  - A spark may result in an explosion or fire.



Take care that the door or any of the other parts do not come into contact with your body while cooking or just after cooking.

  - Failing to do so may result in burns.

In the event of a grease fire on the surface units below the oven, smother the flaming pan on the surface unit by covering the pan completely with a lid, a cookie sheet, or a flat tray.

-  Never leave surface units beneath your oven unattended at high heat settings. Boil overs cause smoking and greasy spillovers that may ignite and spread if the vent fan is operating. To minimize automatic fan operation, use adequate sized cookware and use high heat on surface units only when necessary.
 

If materials inside the oven should ignite, keep the oven door closed, turn the oven off and disconnect the power cord, or shut off power at the fuse or circuit breaker panel. If the door is opened, the fire may spread.

  - Always observe Safety Precautions when using your oven. Never try to repair the oven on your own. There is dangerous voltage inside. If the oven needs to be repaired, contact an authorized service center near you.
-  Do not attempt to repair, disassemble, or modify the appliance yourself.
  - Because a high voltage current enters the product chassis during operation, opening the chassis can result in electric shock or fire.
  - You may be exposed to electromagnetic waves.
  - When the oven requires repair, contact your nearest service center.
-  If any foreign substance such as water enters the microwave, unplug it and contact your nearest service center.
  - Failing to do so may result in electric shock or fire.
-  Do not touch the power plug with wet hands.
  - This may result in electric shock.

Do not turn the appliance off by unplugging the power plug while the appliance is in operation.

  - Plugging the power plug into the wall socket again may cause a spark and result in electric shock or fire.

Keep all packaging materials well out of the reach of children. Packaging materials can be dangerous to children.

  - If a child places a bag over its head, the child can suffocate.

# SAVE THESE INSTRUCTIONS

## Important safety instructions

---

- ❑ Do not let children or any person with reduced physical, sensory or mental capabilities use this appliance unsupervised. Make sure that the appliance is out of the reach of children.
  - Failing to do so may result in electric shock, burns or injury.
- Do not touch the inside of the appliance immediately after cooking. The inside of the appliance will be hot.
- The heat on the inside of the oven can cause burns.  
Do not put aluminum foil (except as specifically directed in this manual), metal objects (such as containers, forks, etc.) or containers with golden or silver rims into the microwave.
  - These objects can cause sparks or a fire.
- Do not use or place flammable sprays or objects near the oven.
- Heat from the microwave can cause flammable sprays to explode or burn.
- Failing to do so may result in electric shock or injury.
- Do not tamper with or make any adjustments or repairs to the door. Under no circumstances should you remove the outer cabinet.
- Do not store or use the oven outdoors.

## USAGE CAUTIONS

---

- ★ If the surface of the microwave is cracked, turn it off.
  - Failing to do so may result in electric shock.Dishes and containers can become hot. Handle with care. Hot foods and steam can cause burns. Carefully remove container coverings, directing steam away from your hands and face. Remove lids from baby food before heating. After heating baby food, stir well to distribute the heat evenly. Always test the temperature by tasting before feeding the baby. The glass jar or surface of the food may appear to be cooler than the food in the interior, which can be so hot that it will burn the infant's mouth. Make sure all cookware used in the oven is suitable for microwaving. Use microwavable cookware in strict compliance with such manufacturer's recommendations.
- ❑ Do not stand on top of the microwave or place objects (such as laundry, oven covers, lighted candles, lighted cigarettes, dishes, chemicals, metal objects, etc.) on the appliance.
  - Items, such as a cloth, may get caught in the door.
  - This may result in electric shock, fire, problems with the product, or injury.Do not operate the appliance with wet hands.
  - This may result in electric shock.Do not spray volatile material such as insecticide onto the surface of the appliance.
  - As well as being harmful to humans, it may also result in electric shock, fire or problems with the product.Do not place the appliance over a fragile object such as a sink or glass object.
  - This may result in damage to the sink or glass object.

## SAVE THESE INSTRUCTIONS



- 
- ☒ Do not put your face or body close to the appliance while cooking or when opening the door just after cooking.
- Take care that children do not come too close to the appliance.
  - Failing to do so may result in children burning themselves.
- Do not place food or heavy objects over the door when opening the door.
- The food or object may fall and this may result in burns or injury.
- Do not abruptly cool the door, the inside of the appliance, or the dish by pouring water over it during or just after cooking.
- This may result in damage to the appliance. The steam or water spray may result in burns or injury.
- Do not cook without the glass tray in place on the oven floor. Food will not cook properly without the tray.
- Do not defrost frozen beverages in narrow-necked bottles. The containers can break.
- Do not scratch the glass of the oven door with a sharp object.
- This may result in the glass being damaged or broken.
- Do not store anything directly on top of the appliance when it is in operation.
- Do not use sealed containers. Remove seals and lids before use. Sealed containers can explode due to buildup of pressure even after the oven has been turned off.

---

## **⚠ CRITICAL CLEANING INSTRUCTIONS**

---

- Do not clean the appliance by spraying water directly onto it.  
Do not use benzene, thinner, or alcohol to clean the appliance.
- This may result in discoloration, deformation, damage, electric shock, or fire.
- Before cleaning or performing maintenance, unplug the appliance from the wall socket and remove food waste from the door and cooking compartment.
- Failing to do so may result in electric shock or fire.
- Take care not to hurt yourself when cleaning the appliance. (external/internal)
- You may hurt yourself on the sharp edges of the appliance.
- Do not clean the appliance with a steam cleaner.
- This may result in corrosion.
- Keep the inside of the oven clean. Food particles or spattered oils stuck to the oven walls or floor can cause paint damage and reduce the efficiency of the oven.

**SAVE THESE INSTRUCTIONS**

## Important safety instructions

# INSTALLING YOUR MICROWAVE OVEN

Place the oven on a flat level surface 33.5 inches (85 cm) above the floor. The surface should be strong enough to safely bear the weight of the oven.

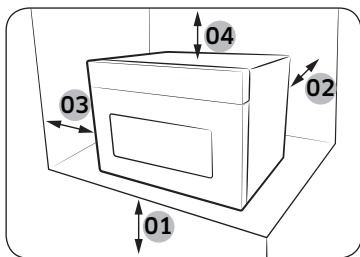

- **NOT FOR BUILT-IN INSTALLATION**
- 1. When you install your oven, make sure there is adequate ventilation for your oven by leaving at least 4 inches (10 cm) of space behind and, on the sides of the oven and 7.875 inches (20 cm) of space above.
- 2. Remove all packing materials inside the oven.
- 3. Install the roller ring and turntable. Check that the turntable rotates freely. (Turntable type model only)

- 01** 33.5 inches (85 cm) from the floor
- 02** 4 inches (10 cm) from the rear wall
- 03** 4 inches (10 cm) from the side
- 04** 7.875 inches (20 cm) from above

4. This microwave oven has to be positioned so that plug is accessible.
- If the supply cord is damaged, it must be replaced by the manufacturer, its service agent or similarly qualified persons in order to avoid a hazard. For your personal safety, plug the cable into a proper AC earthed socket.
  - Do not install the microwave oven in hot or damp surroundings like next to a traditional oven or radiator. The power supply specifications of the oven must be respected and any extension cable used must be of the same standard as the power cable supplied with the oven. Wipe the interior and the door seal with a damp cloth before using your microwave oven for the first time.

# CLEANING THE TURNTABLE AND ROLLER RINGS

Clean the roller rings periodically and wash the turntable as required. You can wash the turntable safely in your dishwasher.

# STORING AND REPAIRING YOUR MICROWAVE OVEN

If you need to store your microwave oven for a short or extended period of time, choose a dust-free, dry location. Dust and dampness may adversely affect the microwave parts.



- Do not repair, replace or service any part of your microwave oven yourself. Allow only a qualified service technician to perform repairs. If the oven is faulty and needs servicing, or you are in doubt about its condition, unplug the oven from the power outlet and contact your nearest service center.
- Do not use the oven if it is damaged, in particular, if the door or door seals are damaged. Door damage includes a broken hinge, a worn out seal, or distorted/bent casing.
- Do not remove the oven from its casing.
- This microwave oven is for home use only and is not intended for commercial use.

## SAVE THESE INSTRUCTIONS

# Installation

## What's included

Make sure all parts and accessories listed on this page and the next page are included in the product package. If you have a problem with the oven or accessories, contact a local Samsung customer center or the retailer.

### Oven at a glance

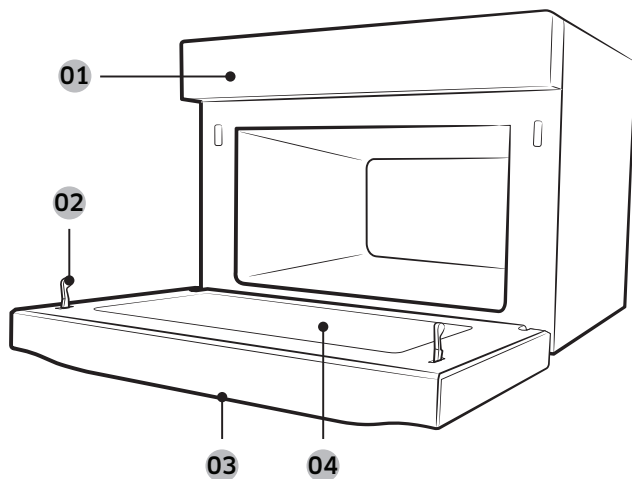

- 01 Control panel      02 Safety Door Lock      03 Door Handle  
04 Door

## Accessories

The oven comes with different accessories that help you prepare different types of food.

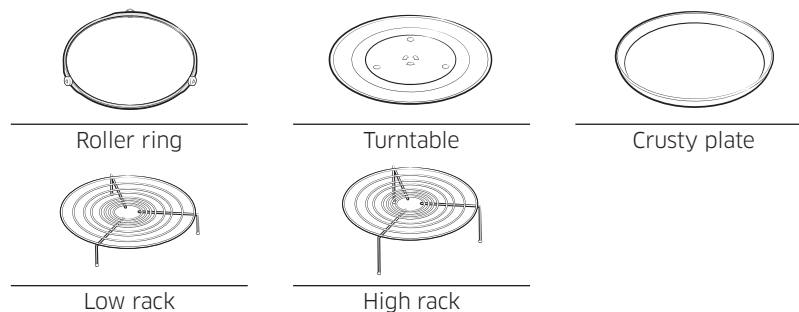

* Roller ring	Put in the center of the base. It supports the turntable.
* Turntable	Put on the roller ring with the center fitting the coupler. It serves as a cooking base.
* Racks	Use one of these racks as appropriate to cook two dishes simultaneously. A smaller dish on the turntable, and the other on the selected rack. You can use these racks with Grill Convection or Combination Cooking. <b>NOTE</b> Do not use wire racks with Microwave mode.
* Crusty plate	Put on the turntable. Use this to brown food, or to keep pastries or pizza crisp.

### IMPORTANT

DO NOT operate the oven without the turntable on the roller ring.

### NOTE

If you need an accessory marked with an \* (asterisk), please contact the Samsung Call Center using the phone number listed on the last page of this manual or visit our on-line parts web site at [www.samsungparts.com](http://www.samsungparts.com).

## Turntable

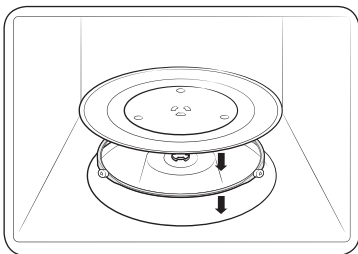

Remove all packing materials inside the oven. Install the roller ring and turntable. Check that the turntable rotates freely.

## Maintenance

### Cleaning

Clean the oven regularly to prevent impurities from building up on or inside the oven. Also pay special attention to the door, door seal, and turntable and roller ring (applicable models only).

If the door won't open or close smoothly, first check if the door seals have built up impurities. Use a soft cloth in soapy water to clean both the inner and outer sides of the oven. Rinse and dry well.

#### To remove stubborn impurities from inside the oven

1. With an empty oven, put a cup of diluted lemon juice on the center of the turntable.
2. Heat the oven for 10 minutes at max power.
3. When the cycle is complete, wait until the oven cools down. Then, open the door and clean the cooking cavity.

#### To clean inside swing-heater models

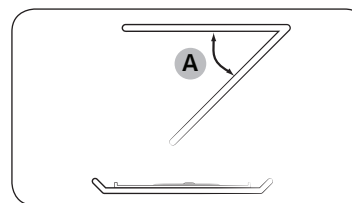

To clean the upper area of the cooking cavity lower the top heating element by 45° (A) as shown. This will help clean the upper area. When done, reposition the top heating element.

#### CAUTION

- Keep the door and door seal, clean and ensure the door opens and closes smoothly. Otherwise, the oven's lifecycle may be shortened.
- Take caution not to spill water into the oven vents.
- Do not use any abrasive or chemical substances for cleaning.
- After each use of the oven, use a mild detergent to clean the cooking cavity after waiting for the oven to cool down.

## Replacement (repair)

### ⚠ WARNING

This oven has no user-removable parts inside. Do not try to replace or repair the oven yourself.

- If you encounter a problem with hinges, seal and/or the door, contact a qualified technician or a local Samsung service center for technical assistance.
- If you want to replace the light bulb, contact a local Samsung service center. Do not replace it yourself.
- If you encounter a problem with the outer housing of the oven, first unplug the power cord from the power source, and then contact a local Samsung service center.

## Care during an extended period of disuse

If you don't use the oven for an extended period of time, unplug the power cord and move the oven to a dry, dust-free location. Dust and moisture that builds up inside the oven may affect the performance of the oven.

## Before you start

There are two microwave components that you should know about before going directly to a recipe. Before or during any cooking mode, you can set/change the clock or the kitchen timer to your needs.

### Clock

It is important to set the correct clock time to ensure correct automatic operations.

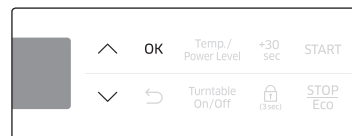
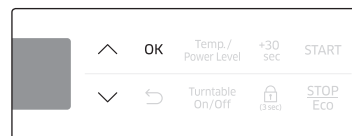

1. Turn on the oven and wait for several seconds for it to enter the Standby state. The hour element blinks.
2. Use the arrow buttons to set the hour, and then press **OK**. The minute element blinks.
3. Use the arrow buttons to set the minute, and then press **OK**.

### 📖 NOTE

- To change the current time later, hold down the up arrow (^) for 3 seconds, and then follow the above steps.
- The clock time cannot be changed during operations.

# Before you start

## Sound On/Off

You can turn on or off the key tone, beep, or alarm. This setting is available only in the Standby state (when the current time is displayed).

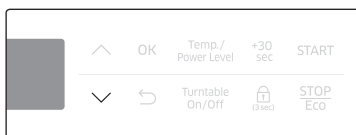

To mute the sound, hold down **V** for 3 seconds. **"OFF"** appears on the display.

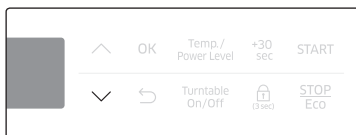

To unmute the sound, hold down **V** again for 3 seconds. **"ON"** appears on the display.

## About microwave energy

Microwaves are high-frequency electromagnetic waves. The oven uses its built-in magnetron to generate microwaves which cook or reheat food without deforming or discolouring the food.

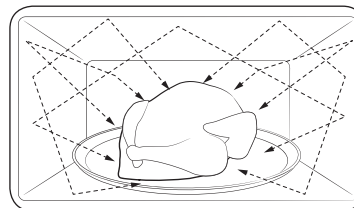

1. The microwaves generated by the magnetron are distributed uniformly by the whirling distribution system. This is why the food is cooked evenly.
2. The microwaves are absorbed into the food up to a depth of approximately 1 inch (2.5 cm). Then, the microwaves are dissipated inside the food as cooking continues.
3. The cooking time is affected by the following conditions of the food:
  - Quantity and density
  - Moisture content
  - Initial temperature (especially, when frozen)

### NOTE

The cooked food keeps heat in its core after cooking is complete. This is why you must observe the standing times specified in this manual, which ensure that the food is cooked evenly down to the core.

## Cookware for microwave mode

Cookware used for Microwave Mode must allow microwaves to pass through and penetrate food. Metals such as stainless steel, aluminum, and copper reflect microwaves. Therefore, do not use cookware made of metallic materials. Cookware marked microwave - safe is always safe for use. For additional information on appropriate cookware, refer to the following guide.

### Requirements:

- Flat bottom and straight sides
- Tight-fitting lid
- Well-balanced pan with handles that weigh less than the main pan

Material	Microwave-safe	Description
Aluminium foil	△	Use for a small serving size to protect against overcooking. Arcing can occur if the foil is near the oven wall or if using an excessive amount of foil.
Crusty plate	○	Do not use for preheating for more than 8 minutes.
Bone china or earthenware	○	Porcelain, pottery, glazed earthenware and bone china are usually microwave-safe, unless decorated with a metal trim.
Disposable polyester cardboard dishes	○	Some frozen foods are packaged in these dishes.
Fast-food packaging	○	Overheating may cause these to melt.
	×	These may catch fire.
	×	These may cause arcing

Material	Microwave-safe	Description
Glassware	○	Microwave-safe unless decorated with metal trims.
	○	Delicate glassware may break or crack if heated rapidly.
	○	Appropriate for warming only. Remove the lid before cooking.
Metal	×	These may cause arcing or fire.
	×	
Paper	○	Use to cook for a short time. These absorb excess moisture.
	×	Causes arcing.
Plastic	○	Use thermoplastic containers only. Some plastics may warp or discolour at high temperatures.
	○	Use to maintain moisture after cooking.
	△	Use boilable or ovenproof bags only.
Wax or grease-proof paper	○	Use to maintain moisture and prevent spattering.

○ : Microwave safe

△ : Use caution

× : Microwave unsafe

# Operations

## Control panel

The front panel comes in a wide range of materials and colors. For improved quality, the actual appearance of the oven is subject to change without notice.

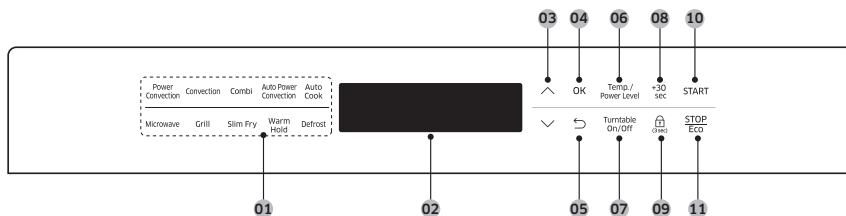

<b>01</b> Feature panel	Press to select a desired cooking mode or function.
<b>02</b> Display	Shows necessary information for selected function or settings.
<b>03</b> Up/Down	Use to adjust the setting value for your selection.
<b>04</b> OK	Press to confirm your settings.
<b>05</b> Back	Press to return to the default setting.
<b>06</b> Temperature/ Power Level	Use to change the temperature or power level.
<b>07</b> Turntable	Press to toggle on and off the turntable.
<b>08</b> +30 sec	Press to add operation time during Microwave mode.
<b>09</b> Child Lock	Press and hold for 3 seconds to activate or deactivate. Child Lock is available only in the Standby state.
<b>10</b> Start	Press to start cooking. This button is also used to fast preheat the oven at the maximum power level.
<b>11</b> Stop/Eco	Press to stop operation. This button is also used to cancel the current mode.

## NOTE

**Standby state:** After 5 minutes of inactivity on the control panel, the oven enters the Standby state where only the current time is displayed. After 25 more minutes of inactivity, the oven enters the Stop state.

## Feature overview

Feature		Temp./ Power range	Default Temp./ Power	Max. time	
Manual mode	Power Convection	300-450 °F	400 °F	60 min.	
		Power Convection is similar to Convection mode. However, the heating elements generate stronger heat and distribute stronger air current inside the oven. This is designed to cook food faster while keeping or improving the taste.			
	Convection	100-450 °F	350 °F	60 min.	
		The heating elements generate heat, which is evenly distributed inside the oven by the convection fan. Use this mode for frozen food or baking.			
	Combi	Cb-1, Grill Combi	10-70 %	70 %	60 min.
			The heating elements generate heat, which is reinforced by microwave energy.		
Combi	Cb-2, Convection Combi	100-400 °F 10-70 %	350 °F 70 %	60 min.	
		The heating elements generate heat and the convection fan distributes the heat inside the oven, which is reinforced by microwave energy.			



Feature		Temp./ Power range	Default Temp./ Power	Max. time
Manual mode	Microwave	10-100 %	100 %	90 min.
	The microwave energy enables food to be cooked or reheated without changing either the form or the color.			
Manual mode	Grill	-	-	60 min.
	Use this for grilling food such as meat.			
Auto mode	Auto Power Convection	To accommodate first-time users of Power Convection mode, the oven offers 14 auto programs.		
	Auto Cook	For cooking beginners, the oven offers a total of 23 auto cooking programs.		
	Defrost	The oven offers 4 defrosting programs for your convenience.		
	Slim Fry	You don't need to set either cooking time or power level. You can adjust the slim fry cook category as shown in this manual (see page 27). You will use less oil compared to frying with an oil fryer and feel much more healthy as you reduce the use of oil.		
Special functions	Warm Hold	125-175 °F	150 °F	3 hrs.
		Use this only for keeping food you have just cooked warm.		

## Manual mode

### Step 1. Select mode

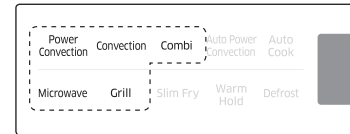

On the feature panel, select a **Manual mode**, for example, **Convection**. The default temperature (or power level) blinks. If you press Combi mode, one of these indicators is displayed:

- Cb-1 (Microwave+Grill)
- Cb-2 (Microwave+Convection)

### Step 2. Set temperature or Power level

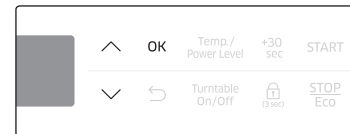

Use the  $\wedge$  /  $\vee$  buttons to adjust the default temperature (or power level). When done, press **OK** to move to the time elements.

#### NOTE

The power level, unless otherwise mentioned, is adjusted according to the set temperature. If the power level or temperature is not specified within 5 seconds, the oven moves to the cooking time.

### Step 3. Set cooking time

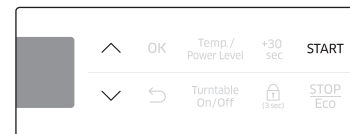

Use the  $\wedge$  /  $\vee$  buttons to set the cooking time. When done, press **START**.

#### NOTE

You can set cooking time after preheating.

### Step 4. Preheat

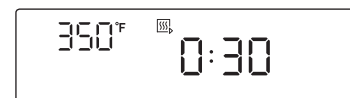

The oven starts preheating until it reaches the set temperature. When complete, the oven beeps and the indicator disappears.

# Operations

## ⚠ CAUTION

- Always use oven gloves while taking out food.
- The microwave fan may continue to operate for 5 minutes after cooking if the temperature in the oven cavity is too hot. ✱ will be displayed.

### To change the cooking time during cooking

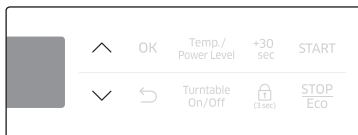

Use the  $\wedge$  /  $\vee$  buttons to adjust the cooking time. Your changes will be applied instantly, and the oven will resume cooking with the new settings.

### To change the temperature or power level during cooking

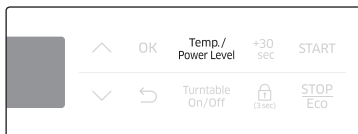

1. Press **Temp./Power Level**. The temperature (or power level) element blinks.

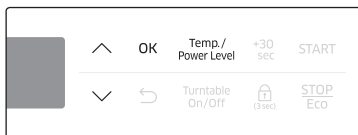

2. Use the  $\wedge$  /  $\vee$  buttons to adjust the temperature (or power level), and then press **OK** or **Temp./Power Level** to confirm the changes.

### To stop operation

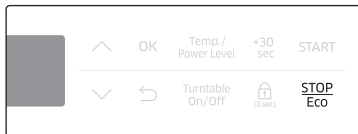

Press **STOP/Eco** once to stop operation, or twice to cancel the current mode and enter the Standby state.

## Power Convection

Power Convection is similar to the Convection mode. However, the heating elements generate higher temperature heat and the fan generates stronger air currents inside the oven. This mode is designed to cook faster while keeping or improving the taste. You can use the Low rack or a combination of the Low rack and Crusty plate on the turntable.

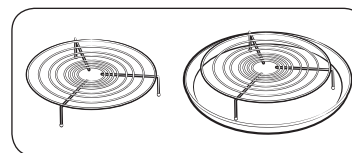
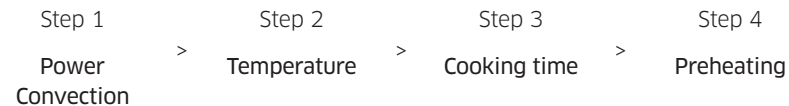

1. Put the Low rack or the combination of the Low rack and Crusty plate on the turntable.

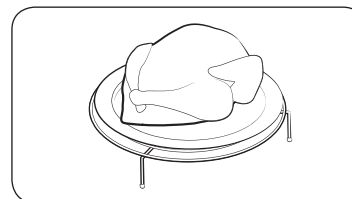

2. Put food in suitable cookware, then put the cookware on the rack and close the door.
3. Follow steps 1-4 in **Manual** mode on page 17.
4. When cooking is complete, "0:00" blinks. Use oven gloves to take out food.

## ⚠ CAUTION

Do not use this mode for baking breads, or cooking confectionery. The stronger heat can burn the tops of food.

## 📖 NOTE

When you push the **START** after setting the temperature, Preheating will start.

## Convection

The heating elements generate heat, which is evenly distributed inside the oven by the convection fan. You can use the Low rack or a combination of the Low rack and Crusty plate on the turntable. Use this mode for biscuits, individual scones, rolls, and cakes as well as fruit cakes, choux pastries, and soufflés.

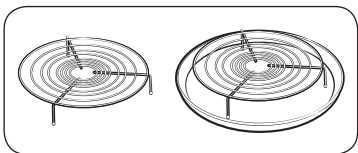
- | Step 1     | Step 2      | Step 3       | Step 4     |
|------------|-------------|--------------|------------|
| Convection | Temperature | Cooking time | Preheating |
- 

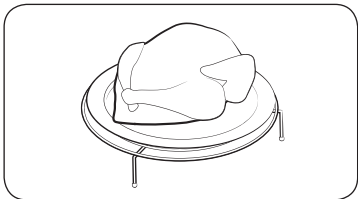
1. Put the Low rack or the combination of the Low rack and Crusty plate on the turntable.
  - 

2. Put food in suitable cookware, then put the cookware on the rack and close the door.
  3. Follow steps 1-4 in **Manual mode** on page 17.
  4. When cooking is complete, "0:00" blinks. Use oven gloves to take out food.

### NOTE

When you push the **START** after setting the temperature, Preheating will start.

## Combi - Grill Combi

The heating elements generate heat, which is reinforced by the microwave energy. Use only microwave-safe cookware, such as glass or ceramic cookware.

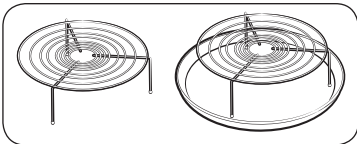
- | Step 1 | Step 2      | Step 3      | Step 4       | Step 5 |
|--------|-------------|-------------|--------------|--------|
| Combo  | Mode (Cb-1) | Power Level | Cooking Time | -      |
- 

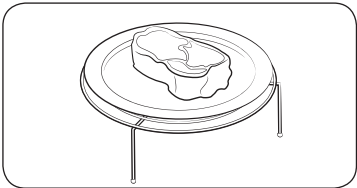
1. Put the High rack or the combination of High rack and Crusty plate on the turntable.
  - 

2. Put food in suitable cookware, then put the cookware on the rack and close the door.
  3. Follow steps 1-3 in **Manual mode** on page 17.
  4. When cooking is complete, "0:00" blinks. Use oven gloves to take out food.

# Operations

## Combi - Convection Combi

This combination mode combines microwave energy with hot air, resulting in reduced cooking time and producing a brown, crispy surface on the food. Use this mode for all kinds of meat and poultry as well as casseroles and gratin dishes, sponge cakes and light fruit cakes, pies and crumbles, roast vegetables, scones, and breads.

Step 1 Combo	>	Step 2 Mode (Cb-2)	>	Step 3 Temperature and Power Level	>	Step 4 Cooking Time	>	Step 5 Preheating
-----------------	---	--------------------------	---	--	---	---------------------------	---	----------------------

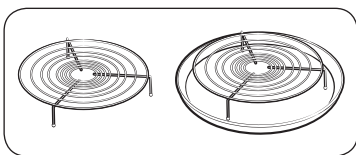

1. Put the Low rack or the combination of the Low rack and Crusty plate on the turntable.

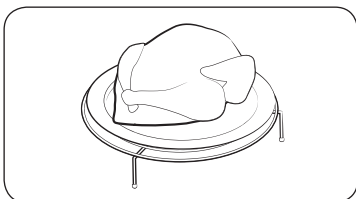

2. Put food in suitable cookware, then put the cookware on the rack and close the door.
3. Follow steps 1-4 in **Manual mode** on page 17.
4. When cooking is complete, "0:00" blinks. Use oven gloves to take out food.

### ⚠ CAUTION

Use only ovenproof cookware, such as cookware made out of glass, pottery, or bone china without metal trim.

## Microwave

Microwaves are high-frequency electromagnetic waves. The microwave energy cooks or reheats food without changing either the form or the color.

- Use only microwave-safe cookware.

Step 1 Microwave	>	Step 2 Power level	>	Step 3 Cooking time	>	Step 4 -
---------------------	---	-----------------------	---	------------------------	---	-------------

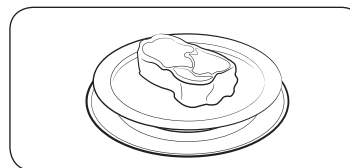

1. Put food in a microwave-safe container, and then place the container in the center of the turntable. Close the door.
2. Follow steps 1-3 in **Manual mode** on page 17.
3. When cooking is complete, "0:00" blinks. Use oven gloves to take out food.

### Simple start

To simply heat food for a short period of time at maximum power, select Microwave, and then press **START** (START).

### Power level

100 %	(High)	50 %	(Medium)
90 %	(Sauté)	40 %	(Medium low)
80 %	(Reheat)	30 %	(Low)
70 %	(Medium high)	20 %	(Defrost)
60 %	(Simmer)	10 %	(Warm)

## Grill

The heating elements generate heat. Make sure they are in the horizontal position.

Step 1 > Step 2 > Step 3 > Step 4  
Grill - Cooking time -

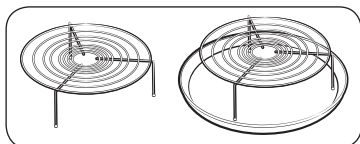

1. Put the High rack or the combination of High rack and Crusty plate on the turntable.

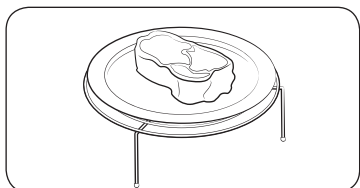

2. Put food in suitable cookware, then put the cookware on the rack and close the door.
3. Follow steps 1 and 3 in **Manual mode** on page 17.
4. When cooking is complete, "0:00" blinks. Use oven gloves to take out food.

## Auto mode

The oven offers 4 different auto modes for your convenience: **Auto Power Convection**, **Auto Cook**, **Slim Fry**, and **Defrost**. Select one that best fits your needs.

### Step 1. Select mode



On the feature panel, press an **auto mode** button, for example, **Auto Power Convection**. The default program number blinks.

### Step 2. Select program

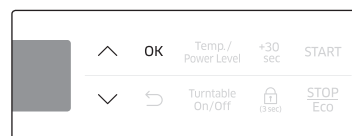

Use the  $\wedge$  /  $\vee$  buttons to select a preferred program, and then press **OK**. The default weight for the program blinks.

### Step 3. Set serving size or weight

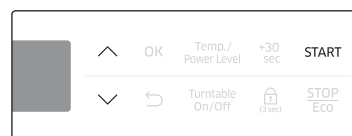

Use the  $\wedge$  /  $\vee$  buttons to set the serving size (or weight). When done, press **START**.

### ⚠ CAUTION

Always use oven gloves when taking out food.

### 📖 NOTE

The cooking time is pre-programmed according to the auto mode and cannot be changed.

# Operations

## Auto Power Convection

Power Convection is similar to the Convection mode. However, the heating elements generate higher temperature heat and the fan generates stronger air currents inside the oven. This mode is designed to cook faster while keeping or improving flavor.

To accommodate first-time users of the Power Convection mode, the oven offers 14 auto programmes.

Step 1 > Step 2 > Step 3  
Auto Power Convection 1 to 14 Serving Size/Weight

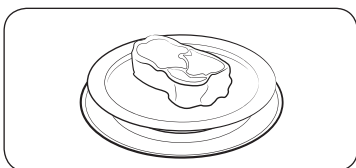

1. Put food in suitable cookware, then put the cookware on the turntable and close the door.
2. Follow steps 1-3 in **Auto mode** on page 21.
3. When cooking is complete, "0:00" blinks. Use oven gloves to take out food.

### ⚠ CAUTION

Do not use this mode for baking breads or cooking confectionery. The higher temperature heat can burn the tops of food.

## Auto Cook

For cooking beginners, the oven offers a total of 23 auto cooking programs. Take advantage of this feature to save time or shorten your learning curve. The cooking time and temperature will be adjusted according to the selected recipe.

Step 1 > Step 2 > Step 3  
Auto 1 to 23 Serving Size/Weight

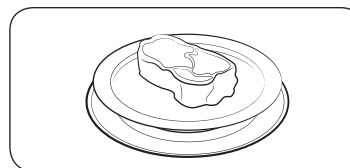

1. Put food in suitable cookware, then put the cookware on the turntable and close the door.
2. Follow steps 1-3 in **Auto mode** on page 21.
3. When cooking is complete, "0:00" blinks. Use oven gloves to take out food.

## Slim Fry

The 8 slim fry cook features include/provide pre-programmed cooking times. You do not need to set either the cooking time or the power level.

You can adjust the slim fry cook category by press the slim fry cook button.

Step 1 > Step 2 > Step 3  
Slim Fry 1 to 8 Serving Size/Weight

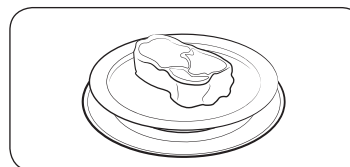

1. Put food in suitable cookware, then put the cookware on the turntable and close the door.
2. Follow steps 1-3 in **Auto mode** on page 21.
3. When cooking is complete, "0:00" blinks. Use oven gloves to take out food.

## Defrost

The oven offers 4 defrosting programs for your convenience. The time and power levels are automatically adjusted according to the selected program.

Step 1 > Step 2 > Step 3  
**Defrost** 1 to 4 weight

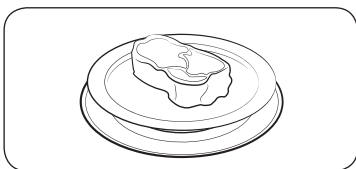

1. Put food in suitable cookware, then put the cookware on the turntable and close the door.
2. Follow steps 1-3 in **Auto mode** on page 21.
3. When defrosting is complete, "0:00" blinks. Use oven gloves to take out food.

## Special functions

### Warm Hold

With this function, only the convection heating element operates, and it cycles on and off to keep food warm.

When cooking is complete,

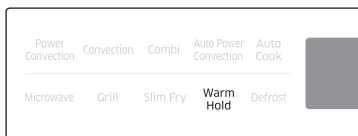

1. On the feature panel, press **Warm Hold**. The default temperature (150 °F) blinks.

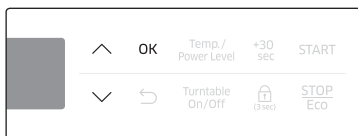

2. Use the  $\wedge$  /  $\vee$  buttons to adjust the temperature, and then press **OK** to move to the time element.

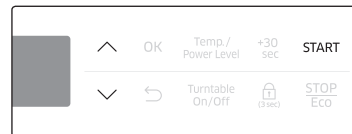

3. Use the  $\wedge$  /  $\vee$  buttons to set the time, and then press **START**. The oven starts warming.

### CAUTION

- Always use oven gloves while taking out food.
- Do not use this function to reheat cold foods. Use this only to keep food that has been cooked warm.
- Do not run this function for more than 3 hour. Otherwise, this may affect food quality.
- To keep food crispy, do not cover the food.

### NOTE

To change the temperature during the cycle, press **Temp./Power Level**, and repeat step 2 above.

See the table on the next page for Keep Warm temperature settings.

### Warm Hold guide

Food	Temperature (°F)	Standing time (min.)	Directions
Meals	175	30	For keeping meat, chicken, gratin, pizza, potatoes, and plated meals warm.
Drinks	175	30	For keeping water, milk, and coffee warm.
Breads/Pastries	150	30	For keeping bread, toast, rolls, muffins, and cake warm.
Dishes/Crockery	150	30	For preheating dishes and crockery. Arrange the dishes over the turntable. Do not overload. (Maximum load: 15 lbs. / 7 kg)

# Cooking Smart

## Auto cooking

### Auto Power Convection guide

Cook No.	Food	Amount	Directions
P1	Bone-In Chicken Pieces	2 servings (18 oz.) 4 servings (36 oz.)	Brush the chicken pieces with oil and seasonings. Place the pieces skin side down on the high rack. When the microwave beeps, turn over Bone-In Chicken Pieces and press start to continue.
P2	Hamburger	2 each (4 oz./each) 4 each (4 oz./each)	Place the hamburgers on the high rack. When the microwave beeps, turn the hamburgers over and press start to continue.
P3	Salmon Fillets	1 serving (1 pieces, 4 oz.) 2 servings (2 pieces, 8 oz.) (1 serving = 1 pc, each pieces = 4 oz.)	Place the salmon fillets on the high rack. As your taste, Brush the Salmon fillets with oil and seasonings.
P4	Sirloin Steak (Medium)	1 inch, 1 lbs.	Place the steak on the high rack. When the microwave beeps, turn over the steak and press start to continue. Let the steak rest for 5 minutes before slicing. As your taste, Brush the Steaks with oil and seasonings.

Cook No.	Food	Amount	Directions
P5	Sirloin Steak (Well Done)	1 inch, 1 lbs.	Place the steak on the high rack. When the microwave beeps, turn over the steak and press start to continue. Let the steak rest for 5 minutes before slicing. As your taste, Brush the Steaks with oil and seasonings.
P6	Boneless Pork Chops	2 servings (2 ea.) 4 servings (4 ea.) (1 serving = 4-5 oz./each)	Place the pork chops on the high rack. When the microwave beeps, turn over the pork chops and press start to continue. As your taste, Brush the Pork chops with oil and seasonings.
P7	Frozen Pizza (6 inch)	6 inch	Place the pizza on the high rack.
P8	Frozen Pizza (12 inch)	12 inch	Place the pizza on the high rack.
P9	Pan Pizza (Deep Dish Style)	22-25 oz.	Place the pizza on the high rack.
P10	Frozen Cheese Sticks	1 : 2 servings 2 : 4 servings (4 sticks per serving)	Place the cheese sticks on the crusty plate, then place the plate on the high rack.
P11	Frozen Chicken Wings	1 serving (6 ea.) 2 servings (12 ea.) (3 ea. per serving)	Place the chicken wings on the crusty plate, then place the plate on the high rack.
P12	Frozen Onion Rings	2 servings (6 ea.) 4 servings (12 ea.) (3 rings per serving)	Place the onion rings on the crusty plate, then place the plate on the high rack.



Cook No.	Food	Amount	Directions
P13	Frozen Oven Chips	2 servings (8 oz.) 4 servings (16 oz.)	Place frozen oven chips on the crusty plate, then place the plate on the high rack.
P14	Frozen Gratin	13-15 oz.	Put into a suitable sized glass Pyrex dish or leave in the original packaging (take care that this is suitable for microwaves and oven heat). Put frozen gratin on the low rack. After cooking stand for 2-3 minutes.

#### Auto cook guide

Cook No.	Food	Amount	Directions
A1	Soup	1 to 4 servings (8 oz./serving)	Pour the refrigerated soup into a microwave safe bowl. Cover with a lid or vented plastic wrap. Stir well before serving.
A2	Pasta	1 to 4 servings (8 oz./serving)	Place the refrigerated pasta on a microwave safe plate or bowl. Cover with a lid or vented plastic wrap. Stir well before serving.
A3	Casserole	1 to 4 servings (8 oz./serving)	Place the refrigerated casserole on a microwave safe plate or bowl. Cover with a lid or vented plastic wrap. Stir well before serving.
A4	Dinner Plate	1 serving	Place the pre-cooked, refrigerated food on a microwave safe plate. Cover the plate with vented plastic wrap or wax paper.

Cook No.	Food	Amount	Directions
A5	Beverage	1 serving : 1/2 cup 2 servings : 1 cup 3 servings : 2 cups	Place the beverage in a microwave safe container.
A6	Pizza Reheat	1 serving : 2 slices 2 servings : 4 slices (3-4 oz./each)	Place the pizza on a microwave safe plate. Do not overlap the slices or cover. Let stand 1-2 minutes before serving.
A7	Frozen Dinner	8-10 oz. (227-283 g) 11-14 oz. (312-397 g) 15-18 oz. (425-510 g)	Remove the outer wrapping and follow the package directions for covering. Let stand 1-3 minutes before serving.
A8	Frozen Breakfast	4-6 oz. (113-170 g) 7-8 oz. (198-227 g)	Remove the outer wrapping and follow the package directions for covering. When microwave beeps, stir and press start to continue. Let stand 1-3 minutes before serving.
A9	Bacon	1 serving : 2 slices 2 servings : 4 slices 3 servings : 6 slices	Layer 2 paper towels on a microwave safe plate and arrange the bacon on the towels. Do not overlap bacon. Cover with an additional paper towel. Remove the paper towel immediately after cooking.
A10	Hot Dogs	1 serving : 2 each 2 servings : 4 each	Pierce the hot dogs 3 times with a fork and place on a microwave safe plate. When the microwave beeps, add the buns and press start to continue.

# Cooking Smart

Cook No.	Food	Amount	Directions
A11	Oatmeal	1 pack 2 packs	Follow the package directions for the recommended amount of water needed. Stir well before and afterwards.
A12	Brownie Mix	1 package	Pour the batter into an 8x8 inch microwave safe pan, then place the pan on the low rack.
A13	Cookie Dough	8 ea.	Place 8 cookies on the crusty plate, then place the tray on the low rack. When the microwave beeps, put the cookies.
A14	Nachos	1 serving	Arrange the tortilla chips uniformly on a microwave safe plate, then place the plate on the high rack. Sprinkle evenly with cheese. Contents : - 2 cups tortilla chips - ½ cup grated cheese
A15	Frozen Soft Pretzels	1 serving : 2 ea. 2 servings : 4 ea.	Place the pretzels on the crusty plate, then place the plate on the high rack.
A16	Popcorn	3.5 oz. 3.0 oz. 1.5 oz.	Heat only one microwave popcorn bag at a time. Be careful when removing the heated bag from the microwave and opening the bag as the steam can easily burn.

Cook No.	Food	Amount	Directions
A17	Melt Butter	1 stick (¼ lbs.) 2 sticks (½ lbs.)	Unwrap the butter and cut the butter stick. Place the butter on a microwave safe dish and cover with wax paper. Stir well afterwards.
A18	Soften Butter	1 stick (¼ lbs.) 2 sticks (½ lbs.)	Remove the butter from the packaging and place on a microwave safe dish.
A19	Melt Chocolate	1 cup chips	Place the chocolate chips in a microwave safe dish. When the microwave beeps, stir well and press start to continue. Unless stirred, the chocolate chips will keep their shape even when the heating time is over.
A20	Soften Ice Cream	1 serving : 1 pint 2 servings : ½ gallon	Remove the lid of the carton. Place the carton in the center of the microwave.
A21	Soften Cream Cheese	1 package (8 oz.)	Unwrap the cream cheese and place on a microwave safe dish
A22	Melt Cheese	1 cup	Place the cheese in a microwave safe bowl and cover with wax paper. Stir well afterwards.
A23	Melt Marshmallows	10 oz.	Place the marshmallows in a large microwave safe dish. Stir well afterwards.

 **NOTE**

The turntable is not rotating while fermenting yogurt.

### Slim Fry guide

Cook No.	Food	Amount	Directions
F1	Frozen Prawns	2 servings (8 oz.) 4 servings (16 oz.)	Place frozen prawns on the crusty plate, then place the plate on the high rack.
F2	Frozen Chicken Nuggets	2 servings (10 ea.) 4 servings (20 ea.) (5 ea. per serving)	Place frozen chicken nuggets on the crusty plate, then place the plate on the high rack.
F3	Frozen Mini Spring Rolls	1 serving (8 oz.) 2 servings (16 oz.)	Place frozen mini spring rolls on the crusty plate, then place the plate on the high rack.
F4	Homemade French Fries	2 servings (8 oz.) 4 servings (12 oz.)	Peel potatoes and cut into sticks with a thickness of 10×10mm. Soak in cold water for 30-40 minutes (Put some salt in the cold water for the osmotic pressure.) Dry them with a towel then brush with 5 g oil. (Have to remove the moisture completely. Otherwise, potatoes may get scorched and stick to the bottom of the tray.) Place them on the crusty plate, then place the plate on the high rack.
F5	Frozen Potato Wedges	2 servings (8 oz.) 4 servings (16 oz.)	Place frozen potato wedges on the crusty plate, then place the plate on the high rack.
F6	Frozen Potato Croquettes	2 servings (8 oz.) 4 servings (16 oz.)	Place frozen potato croquettes on the crusty plate, then place the plate on the high rack.

Cook No.	Food	Amount	Directions
F7	Drumsticks	1 serving (12 oz.) 2 servings (24 oz.) (4 pcs per serving)	Rinse drumsticks and place them on the high rack directly. When the microwave beeps, turn over drumsticks and press start to continue.
F8	Roasted Vegetables	2 servings (8 oz.) 4 servings (16 oz.)	Cut courgettes, carrots, zucchini and brush them with 5 g oil. Place sliced vegetables on the crusty plate, then place the plate on the high rack.

# Cooking Smart

## Defrost guide

Cook No.	Food	Amount	Directions
d1	Meat	0.1-3.5 lbs.	Shield the edges with aluminium foil. Turn the meat over when the oven beeps. This program is suitable for lamb, pork, steaks, chops, and ground meat. For ground meat, place the meat directly on the turntable tray on wax paper. Do not use an extra tray. Let stand, covered with foil, for 5-10 minutes.
d2	Poultry	0.1-3.5 lbs.	Shield the leg and wing tips with aluminium foil. Turn the poultry over when the oven beeps. This program is suitable for whole chicken as well as for chicken portions.
d3	Fish	0.1-3.5 lbs.	Shield the tail of a whole fish with aluminium foil. Turn the fish over when the oven beeps. This program is suitable for whole fish as well as for fish fillets.
d4	Bread/Cake	0.1-2.0 lbs.	Put bread on a piece of paper towel. Turn over as soon as the oven beeps. Place cake on a ceramic plate and if possible, turn over as soon as the oven beeps. (The oven keeps operating and stops only when you open the door.) This program is suitable for all kinds of bread, sliced or whole, as well as for bread rolls and baguettes. Arrange bread rolls in a circle.

## Manual cooking

### Microwave cooking guide

- Do not use metal containers with Microwave mode. Always put food containers on the turntable.
- It is recommended to cover the food for best results.
- After cooking is complete, let the food settle in its own steam.

### Frozen vegetables

- Use a glass Pyrex container with a lid.
- Stir vegetables twice during cooking, and once after cooking.
- Add seasoning after cooking.

Food	Amount	Power	Cooking time (min.)	Standing time (min.)
Spinach	0.3 lb.	60 %	5-6	2-3
	Add 15 ml (1 tbsp.) of cold water.			
Broccoli	0.7 lb.	60 %	8-9	2-3
	Add 30 ml (2 tbsp.) of cold water.			
Peas	0.7 lb.	60 %	7-8	2-3
	Add 15 ml (1 tbsp.) of cold water.			
Green Beans	0.7 lb.	60 %	7½-8½	2-3
	Add 30 ml (2 tbsp.) of cold water.			
Mixed Vegetables (Carrots, Peas, Corn)	0.7 lb.	60 %	7-8	2-3
	Add 15 ml (1 tbsp.) of cold water.			
Mixed Vegetables (Chinese Style)	0.7 lb.	60 %	7½-8½	2-3
	Add 15 ml (1 tbsp.) of cold water.			

### Fresh vegetables

- Use a glass Pyrex container with a lid.
- Add 30-45 ml of cold water (2-3 tbsp.) for every 0.6 lbs..
- Stir once during cooking, and once after cooking.
- Add seasoning after cooking.
- For faster cooking, it is recommended to cut into smaller, even sizes.
- Cook all fresh vegetables using full microwave power (900 W).

Food	Amount	Power	Cooking time (min.)	Standing time (min.)
Broccoli	0.6 lb.	100 %	3-4	3
	1.0 lbs.		5-6	
Prepare even sized florets. Arrange the stems so they point to the center.				
Brussels Sprouts	1.0 lbs.	100 %	4½-5	3
	Let stand 60-75 ml (5-6 tbsp.) water.			
Carrots	1.0 lbs.	100 %	6-7	3
	Cut carrots into even sized slices.			
Cauliflower	0.6 lb.	100 %	3½-4	3
	1.0 lbs.		6-7	
Prepare even sized florets. Cut big florets in half. Arrange stems so they point to the center.				
Zucchini	0.6 lb.	100 %	4-5	3
	Cut zucchini into slices. Add 30 ml (2 tbsp.) water or a knob of butter. Cook until just tender.			
Eggplant	0.6 lb.	100 %	2½-3	3
	Cut eggplant into small slices and sprinkle with 1 tbsp. lemon juice.			
Leeks	0.6 lb.	100 %	3½-4	3
	Cut leeks into thick slices.			

Food	Amount	Power	Cooking time (min.)	Standing time (min.)
Mushrooms	0.25 lb.	100 %	1½-2	3
	0.6 lb.		2½-3	
Prepare small whole or sliced mushrooms. Do not add any water. Sprinkle with lemon juice. Spice with salt and pepper. Drain before serving.				
Onions	0.6 lb.	100 %	5-5½	3
	Cut onions into slices or halves. Add only 15 ml (1 tbsp.) water.			
Pepper	0.6 lb.	100 %	4½-5	3
	Cut pepper into small slices.			
Potatoes	0.6 lb.	100 %	5-6	3
	1.0 lbs.		8-9	
Weigh the peeled potatoes and cut them into similar sized halves or quarters.				
Turnip Cabbage	0.6 lb.	100 %	5½-6	3
	Cut turnip into small cubes.			

# Cooking Smart

## Rice and Pasta

Stir from time to time during and after cooking.

Cook uncovered, and close the lid during settling. Then, drain water thoroughly.

- **Rice:** Use a large glass Pyrex container with a lid against the rice doubling in volume.
- **Pasta:** Use a large glass Pyrex container.

Food	Amount	Power	Cooking time (min.)	Standing time (min.)
White Rice (Parboiled)	1 cup	60 %	19-21	5
	Add 2 cups of cold water for 1 cup of rice.			
	1½ cups	60 %	21-23	5
Add 3 cups of cold water for 1½ cups of rice.				
Brown Rice (Parboiled)	1 cup	60 %	22-24	5
	Add 2 cups of cold water for 1 cup of rice.			
	1½ cups	60 %	24-26	5
Add 3 cups of cold water for 1½ cups of rice.				
Mixed Rice (Rice + Wild Rice)	1 cup	80 %	16-17	5
	Add 2 cups of cold water for 1 cup of rice/wild rice mix.			
Mixed Corn (Rice + Grain)	1 cup	80 %	17-18	5
	Add 1¾ cups of cold water to 1 cup of mixed rice/grain.			
Pasta	1 cup	80 %	10-11	5
	Add 4¼ cups of water.			

## Reheating

- Do not reheat large-sized foods such as joints of meat, which easily overcook.
- It is safer to reheat foods at lower power levels.
- Stir well or turn over during and after cooking.
- Use caution for liquids or baby foods. Stir well before, during, and after cooking with a plastic spoon or glass stirring stick to prevent eruptive boiling and scalding. Keep them inside the oven during the standing time. Allow a longer reheating time than other food types.
- Recommended standing time after reheating is 2-4 minutes. See the table below for reference.

## Liquids

Food	Amount	Power	Cooking time (min.)	Standing time (min.)
Drinks (Coffee, Tea, Water)	150 ml (1 cup)	100 %	1-1½	1-2
	300 ml (2 cups)		2-2½	
450 ml (3 cups)	3-3½			
600 ml (4 cups)	4-4½			
Pour into cups and reheat uncovered: 1 cup in the center, 2 cups opposite of each other, 3 cups in a circle. Keep in microwave oven during standing time and stir well.				
Soup (Chilled)	0.6 lb.	70 %	3½-4	2-3
	0.8 lb.		4½-5	
	1.0 lbs.		6-6½	
	1.2 lbs.		7-7½	
Pour into a deep ceramic plate or deep ceramic bowl. Cover with a plastic lid. Stir well after reheating. Stir again before serving.				
Stew (Chilled)	0.8 lb.	70 %	4½-5½	2-3
	Put stew in a deep ceramic plate. Cover with a plastic lid. Stir occasionally during reheating and again before standing and serving.			

Food	Amount	Power	Cooking time (min.)	Standing time (min.)
Pasta With Sauce (Chilled)	0.8 lb.	70 %	3½-4½	3
	Put pasta (e.g. spaghetti or egg noodles) on a flat ceramic plate. Cover with microwave cling film. Stir before serving.			
Filled Pasta With Sauce (Chilled)	0.8 lb.	70 %	4-5	3
	Put filled pasta (e.g. ravioli, tortellini) in a deep ceramic plate. Cover with a plastic lid. Stir occasionally during reheating and again before standing and serving.			
Plated Meal (Chilled)	0.8 lb.	60 %	4½-5½	3
	1.0 lbs.		5½-6½	
	1.2 lbs.		6½-7½	
Plate a meal of 2-3 chilled components on a ceramic dish. Cover with microwave cling-film.				
Cheese Fondue Ready-to-Serve (Chilled)	0.8 lb.	60 %	6-7	1-2
	Put the ready-to-serve cheese fondue in a suitable sized glass Pyrex bowl with lid. Stir occasionally during and after reheating. Stir well before serving.			

#### Baby foods & Milk

Food	Amount	Power	Cooking time (sec.)	Standing time (min.)
Baby Food (Vegetables + Meat)	0.4 lb.	70 %	30	2-3
	Empty into ceramic deep plate. Cook covered. Stir after cooking time. Before serving, stir well and check the temperature carefully.			
Baby Porridge (Grain + Milk + Fruit)	0.4 lb.	70 %	20	2-3
	Empty into ceramic deep plate. Cook covered. Stir after cooking time. Before serving, stir well and check the temperature carefully.			
Baby Milk	100 ml	30 %	30-40	2-3
	200 ml		60-70	
Stir or shake well and pour into a sterilized glass bottle. Place in the center of turntable. Cook uncovered. Shake well and let stand for at least 3 minutes. Before serving, shake well and check the temperature carefully.				

# Cooking Smart

## Defrost

Put frozen food in a microwave-safe container without a cover. Turn over during defrosting, and drain off liquid and remove giblets after defrosting. For faster defrosting, cut the food into small pieces, and wrap them with aluminum foil before defrosting. When the outer surface of frozen foods begins to melt, stop defrosting and let stand as instructed in the table below. Do not change the default power level (20 %) for defrosting.

Food		Amount	Power	Defrosting time (min.)	Standing time (min.)
Meat	Minced Beef	0.6 lb. 1.1 lbs.	20 %	6-7 8-13	15-30
	Pork Steaks	0.6 lb.		7-8	
	Place the meat on the turntable. Shield thinner edges with aluminium foil. Turn over after half of defrosting time!				
Poultry	Chicken Pieces	1.1 lbs. (2 pcs)	20 %	14-15	15-60
	Whole Chicken	2.7 lbs.		32-34	
First, put chicken pieces first skin-side down, whole chicken first breast-side-down on a flat ceramic plate. Shield the thinner parts like wings and ends with aluminium foil. Turn over after half of defrosting time!					
Fish	Fish Fillets	0.4 lb.	20 %	6-7	10-25
	Whole Fish	0.9 lb.		11-13	
Put frozen fish in the middle of a flat ceramic plate. Arrange the thinner parts under the thicker parts. Shield narrow ends of fillets and tail of whole fish with aluminium foil. Turn over after half of defrosting time!					
Fruit	Berries	0.7 lb.	20 %	6-7	5-10
	Spread fruit on a flat, round glass dish (with a large diameter).				

Food		Amount	Power	Defrosting time (min.)	Standing time (min.)
Bread	Bread Rolls (each ca. 50 g)	2 pcs 4 pcs	20 %	1-1½ 2½-3	5-20
	Toast/Sandwich	0.6 lb.		4-4½	
	German Bread (Wheat + Rye Flour)	1.1 lbs.		7-9	
Arrange rolls in a circle or bread horizontally on kitchen paper in the middle of turntable. Turn over after half of defrosting time!					

## Grilling guide

The grill-heating elements are located on the ceiling of the cooking chamber. These elements operate only when the door is closed and the turntable is rotating. When grilling food, put the food on the high rack unless otherwise instructed. Preheat the grill for 3 minutes with Grill mode, and, unless otherwise instructed below, grill food on the high rack. When grilling is complete, use oven gloves to take out the food.

## Cookware

**Grill:** Use flameproof containers, which may include metal parts. Do not use plastic cookware of any kind.

**Microwave+Grill:** Do not use cookware that is made of metal or plastic substances.

## Food type

Chops, sausages, steaks, hamburgers, bacon and gammon rashers, thin fish portions, sandwiches, and all kinds of toast with toppings.



## Grilling

Food	Amount	Mode	Cooking time	
			1 <sup>st</sup> side (min.)	2 <sup>nd</sup> side (min.)
Toast Slices	4 pcs (each 25 g)	Grill only	5½-6½	-
	Put toast slices side by side on the high rack.			
Grilled Tomatoes	2 pcs (0.9 lb.)	30 % + Grill	7-8	-
	Cut tomatoes into halves. Put some cheese on top. Arrange in a circle in a flat glass Pyrex dish. Place it on the high rack. Stand for 2-3 minutes.			
Tomato + Cheese Toast	4 pcs (0.7 lb.)	20 % + Grill	5-6	-
	Toast the bread slices first. Put the toast with topping on the high rack. Stand for 2-3 minutes			
Toast Hawaii	4 pcs (1.1 lbs.)	30 % + Grill	5-6	-
	Toast the bread slices first. Put the toast with topping on the high rack. Stand for 2-3 minutes.			
Baked Potatoes	1.1 lbs.	50 % + Grill	15-17	-
	Cut potatoes into halves. Brush potatoes with oil and parsley. Put them in a circle on the high rack with the cut side to the grill.			
Baked Apples	2 apples	30 % + Grill	6-7	-
	Core the apples and fill them with raisins and jam. Put some almond slices on top. Put apples on a flat glass Pyrex dish. Place the dish directly on the low rack.			
Chicken Pieces	1.1 lbs. (2 pcs)	30 % + Grill	12-14	9-11
	Brush chicken pieces with oil and spices. Put them in a circle on the high rack. After grilling stand for 2-3 minutes.			

Food	Amount	Mode	Cooking time	
			1 <sup>st</sup> side (min.)	2 <sup>nd</sup> side (min.)
Beef Steaks (Medium)	0.9 lb. (2 pcs)	Grill only	8-10	6-8
	Brush the beef steaks with oil. Lay them in a circle on the high rack. After grilling stand for 2-3 minutes.			
Roast Fish	0.9-1.1 lbs.	30 % + Grill	9-11	5-7
	Brush skin of whole fish with oil and add herbs and spices. Put two fish side by side (head to tail) on the high rack. After grilling stand for 2-3 minutes.			

# Cooking Smart

## Crusty plate

We recommend you to preheat the crusty plate while it's on the turntable for 3-4 minutes.

Food	Amount	Preheat		Cooking	
		Mode	Time (min.)	Mode	Time (min.)
Bacon	0.2 lb. (4-6 slices)	60 % + Grill	3	60 % + Grill	3-4
	Preheat crusty plate. Put slices side by side on crusty plate. Put plate on high rack.				
Potato Wedges	0.6 lb.	60 % + Grill	4	50 % + Grill	9-11
	Rinse and clean potatoes. Cut into wedges or cubes. Brush with olive oil, herbs and spices. Distribute cubes evenly on plate. Put plate on high rack. Turn over after 5-7 minutes.				
Frozen Chicken Nuggets	0.7 lb.	60 % + Grill	4	60 % + Grill	6-8
	Preheat crusty plate. Brush plate with 1 tbsp. oil. Put chicken nuggets on crusty plate. Put plate on the high rack. Turn over after 4-5 minutes.				

## Power Convection guide

Cooking with Power Convection is a powerful combination of the inner grill heater and the convection ring heater with fan at side. The hot air blows from the top of the cavity through holes into the oven. The heating element at top and side and the fan at the side-wall, keeps the hot air circulating evenly.

Use this mode for biscuits, individual scones, rolls, and cakes as well as fruit cakes, choux, and soufflés. Before cooking, preheat with guided temperatures.

All conventional ovenproof cookware, baking tins and sheets – anything you would normally use in a traditional convection oven – can be used.

Food	Amount	Temperature	Cooking time (min.)
Frozen Mini Tartes/ Pizza Snacks	0.6 lb.	400 °F	9-12
	Put pizza snacks on the crusty plate. Put plate on low rack.		
Frozen Oven Chips	0.7 lb.	400 °F	14-16
	Distribute frozen oven chips on crusty plate. Put plate on high rack.		
Frozen Chicken Nuggets	0.7 lb.	400 °F	7-9
	Put frozen nuggets on crusty plate. Put plate on the high rack.		
Frozen Pizza	0.7 lb.	400 °F	11-13
	Put frozen Pizza on the low rack.		
Homemade Lasagna/ Pasta Gratin	1.1 lbs.	350 °F	25-30
	Put pasta in ovenproof dish. Put dish on low rack.		
Roast Vegetables	0.7 lb.	400 °F	10-12
	Rinse and prepare vegetables in slices (e.g. courgette, egg plants, pepper, pumpkin). Brush with olive oil and add spices. Put on crusty plate on high rack.		

## Convection guide

### Convection

In Convection mode, both the heating element and the side-wall fan operate together to circulate the heat inside the cooking chamber. Use this mode for biscuits, individual scones, rolls, and cakes as well as fruit cakes, choux, and soufflés. All conventional ovenproof cookware, baking tins and sheets - anything you would normally use in a traditional convection oven - can be used.

### Microwaves+Convection

This combination mode combines the microwave energy with hot air, resulting in reduced cooking time and producing a brown, crispy surface of the food. The oven offers 5 different combination modes for your convenience. Use this for all kinds of meat and poultry as well as casseroles and gratin dishes, sponge cakes and light fruit cakes, pies and crumbles, roast vegetables, scones, and breads. Use only ovenproof cookware, such as glasses, potteries, or bone china without metal trim.

Before cooking, preheat with guided temperatures, and wait until the cycle is complete. Set the power level and cooking time as instructed below. Use oven gloves when taking out food.

Food		Amount	Power		Cooking time	
			1 <sup>st</sup> Step	2 <sup>nd</sup> Step	1 <sup>st</sup> Step (min.)	2 <sup>nd</sup> Step (min.)
Pizza	Frozen Pizza (Ready Baked)	0.7-0.9 lb.	30 % + 400 °F	Conv. 350 °F	9-11	4-6
		Place the pizza on the low rack. After baking, let stand for 2-3 minutes.				
Pasta	Frozen Lasagne	0.9 lb.	30 % + 400 °F	Conv. 400 °F	16-18	3-4
		Put into a suitable sized glass pyrex dish or leave in the original packaging (take care that this is suitable for microwaves and oven heat). Put frozen pasta gratin on the low rack. After cooking, let stand for 2-3 minutes.				

Food		Amount	Power		Cooking time	
			1 <sup>st</sup> Step	2 <sup>nd</sup> Step	1 <sup>st</sup> Step (min.)	2 <sup>nd</sup> Step (min.)
Meat	Roast Beef/ Lamb (Medium)	2.7-2.9 lbs.	30 % + 350 °F		22-25	14-16
	Brush beef/lamb with oil and spice it with pepper, salt and paprika. Put it on the low rack, first with the fat side down. After cooking, wrap in aluminium foil and let stand for 10-15 minutes.					
	Roast Chicken	2.6-2.8 lbs.	30 % + 400 °F	30 % + 400 °F	24-26	23-25
	Brush chicken with oil and spices. For the first step, put the chicken breast side down on the low rack. For the second step, turn the chicken breast side up. Let stand for 5 minutes.					
Bread	Frozen Bread Rolls	0.8 lb. (6 pcs)	30 % + 350 °F		7-9	-
	Put bread rolls in a circle on the crusty plate, then on the low rack. Let stand for 2-3 minutes.					
	Garlic Bread (Chilled, Prebaked)	0.45 lb. (1 pc)	30 % + 400 °F		7-9	-
	Put the chilled baguette on baking paper on the low rack. After baking, let stand for 2-3 minutes.					
Cake	Marble Cake (Fresh Dough)	1.1 lbs.	Only 350 °F		38-43	-
	Put the fresh dough in a small rectangular black metal baking dish (length 25 cm). Put the cake on the low rack. After baking, let stand for 5-10 minutes.					
	Small Cakes (Fresh Dough)	12 x 0.06 lb.	Only 325 °F		25-28	-
Fill the fresh dough evenly in paper cups and set on crusty plate on the low rack. After baking, let stand for 5 minutes.						
	Cookies (Fresh Dough)	0.45-0.6 lb.	Only 400 °F		13-17	-
	Put the chilled croissants on baking paper on the low rack.					

# Cooking Smart

---

## Quick & Easy

---

### Melting butter

Put about 3 tbsp. butter into a small deep glass dish. Cover with plastic lid. Heat for 30-40 seconds using 90 %, until butter is melted.

### Melting chocolate

Put about a half cup (¼ lb.) chocolate into a small deep glass dish. Heat for 3-5 minutes, using 50 % until chocolate is melted. Stir once or twice during melting. Use oven gloves while taking out!

### Melting crystallized honey

Put ¾ oz. (20 g) crystallized honey into a small deep glass dish. Heat for 20-30 seconds using 30 %, until honey is melted.

### Melting gelatine

Lay dry gelatine sheets ½ oz. (10 g) for 5 minutes in cold water. Put drained gelatine into a small glass Pyrex bowl. Heat for 1 minute using 30 %. Stir after melting.

### Cooking glaze/icing (for cake and gateaux)

Mix instant glaze (approximately 3 tbsp.) with 2⅓ tbsp. (40 g) sugar and 1 cup (250 ml) cold water. Cook uncovered in a glass Pyrex bowl for 3½ to 4½ minutes using 90 %, until glaze/icing is transparent. Stir twice during cooking.

### Cooking jam

Put 21 oz. of fruit (600 g or about 2½ cups) (for example mixed berries) in a suitable sized glass Pyrex bowl with lid. Add 1½ cups (300 g) preserving sugar and stir well. Cook covered for 10-12 minutes using 90 %. Stir several times during cooking. Empty directly into small jam glasses with twist-off lids. Let stand with the lid on for 5 minutes.

### Cooking pudding

Mix the pudding mix with milk following the manufacturer's instructions. Add sugar if instructed. Stir well. Use a suitable sized glass Pyrex bowl with lid. Cook covered for 6½ to 7½ minutes using 90 %. Stir several times well during cooking.

### Browning almond slices

Spread about 1 oz. (30 g) of sliced almonds evenly on a medium sized ceramic plate. Stir several times during browning for 3½ to 4½ minutes using 60 %. Let it stand for 2-3 minutes in the oven. Use oven gloves when taking out!

# Troubleshooting

If you encounter a problem using your microwave, first check the table below and try the recommendations. If a problem persists, or if an information code keeps appearing on the display, contact a local Samsung service center.

## Checkpoints

Problem	Cause	Action
General		
The buttons cannot be pressed properly.	Foreign matter may be caught between the buttons.	Remove the foreign matter and try again.
	For touch models: Moisture is on the exterior.	Wipe the moisture from the exterior.
	Child lock is activated.	Deactivate Child lock.
The time is not displayed.	The Eco (power-saving) function is set.	Turn off the Eco function.
The oven does not work.	Power is not supplied.	Make sure power is supplied.
	The door is open.	Close the door and try again.
	The door open safety mechanisms are covered in foreign matter.	Remove the foreign matter and try again.
The oven stops while in operation.	The user has opened the door to turn food over.	After turning over the food, press the Start button again to start operation.

Problem	Cause	Action
The power turns off during operation.	The oven has been cooking for an extended period of time.	After cooking for an extended period of time, let the oven cool.
	The cooling fan is not working.	Listen for the sound of the cooling fan.
	Trying to operate the oven without food inside.	Put food in the oven.
	There is not sufficient ventilation space for the oven.	There are intake/exhaust outlets on the front and rear of the oven for ventilation. Keep the gaps specified in the product installation guide.
	Several power plugs are being used in the same socket.	Designate only one socket to be used for the oven.
There is a popping sound during operation, and the oven doesn't work.	Cooking sealed food or using a container with a lid may causes popping sounds.	Do not use sealed containers as they may burst during cooking due to expansion of the contents.
The oven exterior is too hot during operation.	There is not sufficient ventilation space for the oven.	There are intake/exhaust outlets on the front and rear of the oven for ventilation. Keep the gaps specified in the product installation guide.
	Objects are on top of the oven.	Remove all objects on the top of the oven.
The door cannot be opened properly.	Food residue is stuck between the door and oven interior.	Clean the oven and then open the door.

# Troubleshooting

Problem	Cause	Action
Heating including the Warm function does not work properly.	The oven may not work, too much food is being cooked, or improper cookware is being used.	Put one cup of water in a microwave-safe container and run the microwave for 1-2 minutes to check whether the water is heated. Reduce the amount of food and start the function again. Use a cooking container with a flat bottom.
The thaw function does not work.	Too much food is being cooked.	Reduce the amount of food and start the function again.
The interior light is dim or does not turn on.	The door has been left open for a long time.	The interior light may automatically turn off when the Eco function operates. Close and reopen the door or press the Cancel button.
	The interior light is covered by foreign matter.	Clean the inside of the oven and check again.
A beeping sound occurs during cooking.	If the Auto Cook function is being used, this beeping sound means it's time to turn over the food during thawing.	After turning over the food, press the Start button again to restart operation.
The oven is not level.	The oven is installed on an uneven surface.	Make sure the oven is installed on flat, stable surface.
There are sparks during cooking.	Metal containers are used during the oven/thawing functions.	Do not use metal containers.
When power is connected, the oven immediately starts to work.	The door is not properly closed.	Close the door and check again.

Problem	Cause	Action
There is electricity coming from the oven.	The power or power socket is not properly grounded.	Make sure the power and power socket are properly grounded.
<ol style="list-style-type: none"> <li>1. Water drips.</li> <li>2. Steam emits through a door crack.</li> <li>3. Water remains in the oven.</li> </ol>	There may be water or steam in some cases depending on the food. This is not an oven malfunction.	Let the oven cool and then wipe with a dry dish towel.
The brightness inside the oven varies.	Brightness changes depending on power output changes according to function.	Power output changes during cooking are not malfunctions. This is not an oven malfunction.
Cooking is finished, but the cooling fan is still running.	To ventilate the oven, the cooling fan continues to run for about 3 minutes after cooking is complete.	This is not an oven malfunction.
<b>Turntable</b>		
While turning, the turntable comes out of place or stops turning.	There is no roller ring, or the roller ring is not properly in place.	Install the roller ring and then try again.
The turn table drags while turning.	The roller ring is not properly in place, there is too much food, or the container is too large and touches the inside of the microwave.	Adjust the amount of food and do not use containers that are too large.
The turn table rattles while turning and is noisy.	Food residue is stuck to the bottom of the oven.	Remove any food residue stuck to the bottom of the oven.

Problem	Cause	Action
<b>Grill</b>		
<b>Smoke comes out during operation.</b>	During initial operation, smoke may come from the heating elements when you first use the oven.	This is not a malfunction, and if you run the oven 2-3 times, it should stop.
	Food is on the heating elements.	Let the oven cool and then remove the food from the heating elements.
	Food is too close to the grill.	Put the food a suitable distance away while cooking.
	Food is not properly prepared and/or arranged.	Make sure food is properly prepared and arranged.
<b>Oven</b>		
<b>The oven does not heat.</b>	The door is open.	Close the door and try again.
<b>Smoke comes out during preheating.</b>	During initial operation, smoke may come from the heating elements when you first use the oven.	This is not a malfunction, and if you run the oven 2-3 times, it should stop.
	Food is on the heating elements.	Let the oven cool and then remove the food from the heating elements.
<b>There is a burning or plastic smell when using the oven.</b>	Plastic or non heat-resistant cookware is used.	Use glass cookware suitable for high temperatures.

Problem	Cause	Action
<b>There is a bad smell coming from inside the oven.</b>	Food residue or plastic has melted and stuck to the interior.	Use the steam function and then wipe with a dry cloth. You can put a lemon slice inside and run the oven to remove the odour more quickly.
<b>The oven does not cook properly.</b>	The oven door is frequently opened during cooking.	If you open the door often, the interior temperature will be lowered and this may affect the results of your cooking.
	The oven controls are not correctly set.	Correctly set the oven controls and try again.
	The grill or other accessories are not correctly inserted.	Correctly insert the accessories.
	The wrong type or size of cookware is used.	Use suitable cookware with flat bottoms.

## Information codes

If the oven fails to operate, you may see an information code on the display. Check the table below and try the suggestions.

Code	Description	Action
C-20	The temperature sensor is open.	Unplug the power cord of the oven, and contact a local Samsung service center.
	The temperature sensor is shorted.	
C-A1	The oven has failed to sense the opening or closing of the damper for 1 minute.	
C-F0	The microwave has sensed an internal communications failure.	
C-21	Temperature sensor has detected a temperature that exceeds the allowable temperature for an operation.	Turn off the microwave oven, unplug it, and let it cool, then try the setting again. If this code re-appears, call your local Samsung service center.
C-F2	The touch key malfunction.	Press <b>Stop</b> to try again.
C-d0		Turn off the microwave oven, unplug it, and let it cool. Clean the button and area around the button. If this code re-appears, call your local Samsung service center.

## Technical specifications

SAMSUNG strives to improve its products at all times. Both the design specifications and the user instructions are thus subject to change without notice.

Power Source		120 V ~ 60 Hz
Power Consumption	Maximum Power	1650 W
	Microwave	1600 W
	Grill	1600 W
	Convection	1650 W
	Power Convection	1650 W
Output Power		100 W / 900 W (IEC - 705)
Operating Frequency		2450 MHz
Magnetron		OM75P (20)
Cooling Method		Cooling fan motor
Dimensions (W x H x D)	Main Unit (Include Handle)	20.78 x 16 x 18.5 in (528 x 404 x 470 mm)
	Cooking Chamber	15.75 x 8.62 x 15.61 in (400 x 219 x 396.5 mm)
Volume		9 gallons (35 liters)
Weight	Net	Approx. 62.83 lb. (28.5 kg)



# Warranty

---

## Samsung microwave oven

---

### Limited warranty to original purchaser

This SAMSUNG brand product, as supplied and distributed by Samsung Electronics America, Inc. (SAMSUNG) and delivered new, in the original carton to the original consumer purchaser, is warranted by SAMSUNG against manufacturing defects in materials and workmanship for a limited warranty period of:

### **ONE (1) YEAR PARTS AND LABOR, TEN (10) YEARS PARTS WARRANTY FOR MAGNETRON**

Samsung will charge a repair fee for replacing an accessory or repairing a cosmetic defect if the damage to the unit and/or damage to or loss of the accessory was caused by the customer. Items this stipulation covers include:

- A Dented, Scratched, or Broken Door, Handle, Out-Panel, or Control Panel
- A Broken or missing Tray, Guide Roller, Coupler, Filter, or Wire Rack

User Replaceable Parts may be sent to the customer for unit repair. If necessary, a Service Engineer can be dispatched to perform service.

This limited warranty begins on the original date of purchase, and is valid only on products purchased and used in the United States. To receive warranty service, the purchaser must contact SAMSUNG for problem determination and service procedures. Warranty service can only be performed by a SAMSUNG authorized service center. The original dated bill of sale must be presented upon request as proof of purchase to SAMSUNG or SAMSUNG's authorized service center.

SAMSUNG will repair this product or replace it if cannot repair it, at our option and at no charge as stipulated herein, with new or reconditioned parts or products if found to be defective during the limited warranty period specified above. All replaced parts and products become the property of SAMSUNG and must be returned to SAMSUNG. Replacement parts and products assume the remaining original warranty, or ninety (90) days, whichever is longer.

In-home service will be provided during the warranty labor period subject to availability within the contiguous United States. Inhome service is not available in all areas. To receive in-home service, the product must be unobstructed and accessible to service personnel. If during in-home service repair can not be completed, it may be necessary to remove, repair and return the product. If in-home service is unavailable, SAMSUNG may elect, at our option, to provide for transportation of our choice to and from a SAMSUNG authorized service center. Otherwise, transportation to and from the SAMSUNG authorized service center is the responsibility of the purchaser.

This limited warranty covers manufacturing defects in materials and workmanship encountered in normal, noncommercial use of this product and shall not apply to the following, including, but not limited to: damage which occurs in shipment; delivery and installation; applications and uses for which this product was not intended; altered product or serial numbers; cosmetic damage or exterior finish; accidents, abuse, neglect, fire, water, lightning or other acts of nature; use of products, equipment, systems, utilities, services, parts, supplies, accessories, applications, installations, repairs, external wiring or connectors not supplied or authorized by SAMSUNG which damage this product or result in service problems; incorrect electrical line voltage, fluctuations and surges; customer adjustments and failure to follow operating instructions, cleaning, maintenance and environmental instructions that are covered and prescribed in the instruction book; problems caused by pest infestations, and overheating or overcooking by user; glass tray or turntable; reduced magnetron power output related to normal aging. SAMSUNG does not warrant uninterrupted or error-free operation of the product.

# Warranty

---

THERE ARE NO EXPRESS WARRANTIES OTHER THAN THOSE LISTED AND DESCRIBED ABOVE, AND NO WARRANTIES WHETHER EXPRESS OR IMPLIED, INCLUDING, BUT NOT LIMITED TO, ANY IMPLIED WARRANTIES OF MERCHANTABILITY OR FITNESS FOR A PARTICULAR PURPOSE, SHALL APPLY AFTER THE EXPRESS WARRANTY PERIODS STATED ABOVE, AND NO OTHER EXPRESS WARRANTY OR GUARANTY GIVEN BY ANY PERSON, FIRM OR CORPORATION WITH RESPECT TO THIS PRODUCT SHALL BE BINDING ON SAMSUNG. SAMSUNG SHALL NOT BE LIABLE FOR LOSS OF REVENUE OR PROFITS, FAILURE TO REALIZE SAVINGS OR OTHER BENEFITS, OR ANY OTHER SPECIAL, INCIDENTAL OR CONSEQUENTIAL DAMAGES CAUSED BY THE USE, MISUSE OR INABILITY TO USE THIS PRODUCT, REGARDLESS OF THE LEGAL THEORY ON WHICH THE CLAIM IS BASED, AND EVEN IF SAMSUNG HAS BEEN ADVISED OF THE POSSIBILITY OF SUCH DAMAGES. NOR SHALL RECOVERY OF ANY KIND AGAINST SAMSUNG BE GREATER IN AMOUNT THAN THE PURCHASE PRICE OF THE PRODUCT SOLD BY SAMSUNG AND CAUSING THE ALLEGED DAMAGE. WITHOUT LIMITING THE FOREGOING, PURCHASER ASSUMES ALL RISK AND LIABILITY FOR LOSS, DAMAGE OR INJURY TO PURCHASER AND PURCHASER'S PROPERTY AND TO OTHERS AND THEIR PROPERTY ARISING OUT OF THE USE, MISUSE OR INABILITY TO USE THIS PRODUCT SOLD BY SAMSUNG NOT CAUSED DIRECTLY BY THE NEGLIGENCE OF SAMSUNG. THIS LIMITED WARRANTY SHALL NOT EXTEND TO ANYONE OTHER THAN THE ORIGINAL PURCHASER OF THIS PRODUCT, IS NONTRANSFERABLE AND STATES YOUR EXCLUSIVE REMEDY.

Some states do not allow limitations on how long an implied warranty lasts, or the exclusion or limitation of incidental or consequential damages, so the above limitations or exclusions may not apply to you. This warranty gives you specific legal rights, and you may also have other rights which vary from state to state. To obtain warranty service, please contact SAMSUNG at:

**1-800-SAMSUNG (726-7864) or [www.samsung.com/us/support](http://www.samsung.com/us/support)**

# Memo

---



Scan this with your smartphone

Scan the QR code\* or visit  
[www.samsung.com/spsn](http://www.samsung.com/spsn)  
to view our helpful  
How-to Videos and Live Shows

\*Requires reader to be installed on your  
smartphone

Please be advised that the Samsung warranty does NOT cover service calls to explain product operation, correct improper installation, or perform normal cleaning or maintenance.

QUESTIONS OR COMMENTS?

COUNTRY	CALL	OR VISIT US ONLINE AT
U.S.A Consumer Electronics	1-800-SAMSUNG (726-7864)	<a href="http://www.samsung.com/us/support">www.samsung.com/us/support</a>
CANADA	1-800-SAMSUNG (726-7864)	<a href="http://www.samsung.com/ca/support">www.samsung.com/ca/support</a> (English) <a href="http://www.samsung.com/ca_fr/support">www.samsung.com/ca_fr/support</a> (French)

## Free Manuals Download Website

<http://myh66.com>

<http://usermanuals.us>

<http://www.somanuals.com>

<http://www.4manuals.cc>

<http://www.manual-lib.com>

<http://www.404manual.com>

<http://www.luxmanual.com>

<http://aubethermostatmanual.com>

Golf course search by state

<http://golfingnear.com>

Email search by domain

<http://emailbydomain.com>

Auto manuals search

<http://auto.somanuals.com>

TV manuals search

<http://tv.somanuals.com>