

SAMSUNG

Microwave Oven

Owner's Manual

MD800

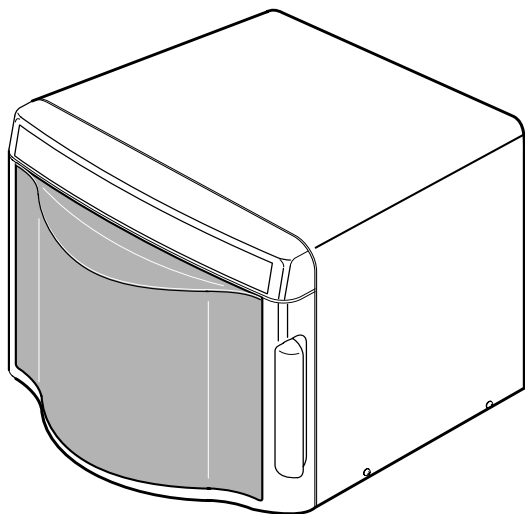

Safety	2
Your New Microwave oven	5
Checking Parts	5
Warranty and Service Information	5
Setting Up Your Microwave Oven	6
Control Panel Buttons.....	6
Operation	7
Setting the Clock	7
Using the Pause/Cancel Button.....	7
Using the One Minute+ Button	8
Defrosting	8
Using the Instant Cook Buttons	9
Instant Cook Chart	9
Cooking Instructions	10
Time Cooking	10
Cooking Utensils.....	11
Testing Utensils	11
Cooking Techniques.....	12
Cooking Guide.....	13
Recipes.....	16
Appendix	18
Troubleshooting Guide	18
Care and Cleaning.....	18
Specifications	19
Warranty	19
Quick Reference	20

PRECAUTIONS TO AVOID POSSIBLE EXPOSURE TO EXCESSIVE MICROWAVE ENERGY:

- (a) Do not attempt to operate this oven with the door open since open-door operation can result in harmful exposure to microwave energy. It is important not to defeat or tamper with the safety interlocks.
- (b) Do not place any object between the oven front face and the door or allow soil or cleaner residue to accumulate on sealing surfaces.
- (c) Do not operate the oven if it is damaged. It is particularly important that the oven door close properly and that there is no damage to the
 - 1) Door (bent or dented),
 - 2) Hinges and latches (broken or loosened),
 - 3) Door seals and sealing surfaces.
- (d) The oven should not be adjusted or repaired by anyone except properly qualified service personnel.

WARNING

Always observe Safety Precautions when using your oven. Never try to repair the oven on your own – there is dangerous voltage inside. If the oven needs to be repaired, call 1-800-SAMSUNG for the name of an authorized service center near you.

IMPORTANT SAFETY INSTRUCTIONS

When using any electrical appliance, basic safety precautions should be followed, including the following:

WARNING

- To reduce risk of burns, electric shock, fire, personal injury or exposure to excessive microwave energy:
 - Read all safety instructions before using the appliance.
 - Read and follow the specific “**PRECAUTIONS TO AVOID POSSIBLE EXPOSURE TO EXCESSIVE MICROWAVE ENERGY**” on this page.
 - This appliance must be grounded. Connect only to properly grounded outlets. See “**IMPORTANT GROUNDING INSTRUCTIONS**” on page 3 of this manual.
 - Install or place this appliance only in accordance with the installation instructions provided.
- Some items, like whole eggs and food in sealed containers, may explode if heated in this oven.
- Use this appliance only for its intended use as described in the manual. Do not use corrosive chemicals or vapors in this appliance. This type of oven is specifically designed to heat, cook, or dry food. It is not designed for industrial or laboratory use.
- As with any appliance, close supervision is necessary when used by children.
- Do not operate this appliance if it has a damaged cord or plug, if it is not working properly, or if it has been damaged.
- This appliance should be serviced only by qualified service personnel. Contact the nearest authorized service facility for examination, repair, or adjustment.
- Do not cover or block any of the openings on this appliance.
- Do not store this appliance outdoors. Do not use near water – for example, near a kitchen sink, in a wet basement, or near a swimming pool, etc.

SAVE THESE INSTRUCTIONS

Safety

Important Safety Instructions, continued

- Keep the inside of the oven clean. Food particles or spattered oils stuck to the oven walls or floor can cause paint damage and reduce the efficiency of the oven.
- Do not immerse cord or plug in water.
- Keep cord away from heated surfaces.
- Do not let cord hang over edge of table or counter.
- When cleaning door and oven surfaces, use only mild, nonabrasive soaps or detergents applied with a sponge or soft cloth.
- To reduce the risk of fire in the oven:
 - a. Do not overcook food. Watch appliance carefully if paper, plastic, or other combustible materials are inside.
 - b. Remove wire twist-ties from plastic cooking bags before placing bags in oven.
 - c. If materials inside the oven ignite, keep the oven door closed, turn the oven off, disconnect the power cord, or shut off the power at the fuse or circuit breaker panel.
 - d. Do not use the oven compartment for storage purposes. Do not leave paper products, cooking utensils, or food in the oven when not in use.
- Do not try to preheat oven or operate while empty.
- Do not cook without the glass tray in place on the oven floor. Food will not cook properly without the tray.
- Do not defrost frozen beverages in narrow-necked bottles. The containers can break.
- Dishes and containers can become hot. Handle with care.
- Carefully remove container coverings, directing steam away from hands and face.
- Remove lids from baby food before heating. After heating baby food, stir well and test temperature by tasting before serving.
- A short power-supply cord is provided to reduce the risk of becoming entangled in or tripping over a longer cord. Longer cord sets or extension cords are available and may be used with caution.
- Do not operate any other heating or cooking appliance beneath this appliance.
- Do not mount unit over or near any portion of a heating or cooking appliance.
- Do not mount over a sink.

IMPORTANT GROUNDING INSTRUCTIONS

This appliance must be grounded. In the event of an electrical short circuit, grounding reduces the risk of electric shock by providing an escape wire for the electrical current. This appliance is equipped with a cord that includes a grounding wire and a grounding plug. The plug must be plugged into an outlet that is properly installed and grounded. Plug the three-prong power cord into a properly grounded outlet of standard 115-120 voltage, 60 Hz. Your oven should be the only appliance on this circuit.

SAVE THESE INSTRUCTIONS

Safety



WARNING

Improper use of the grounding plug can result in a risk of electric shock. Consult a qualified electrician or servicer if you do not understand the grounding instructions or if you are not sure if the appliance is properly grounded.

Use of Extension Cords

A short power-supply cord is provided to reduce the risk of becoming entangled in or tripping over a longer cord. Longer cord sets or extension cords are available and may be used if care is exercised in their use. If a long cord or extension cord is used:

1. The marked electrical rating of the cord set or extension cord should be at least as great as the electrical rating of the appliance.
2. The extension cord must be a grounding-type 3-wire cord and it must be plugged into a 3-slot outlet.
3. The longer cord should be arranged so that it will not drape over the counter top or tabletop where it can be pulled on by children or tripped over accidentally. If you use an extension cord, the interior light may flicker and the blower may vary when the microwave oven is on. Cooking times may be longer, too.



WARNING

Do not cut or remove the third (ground) prong from the power cord under any circumstances.

Note

Connect the oven to a 20A circuit.
When connecting the oven to 15A circuit, make sure that circuit breaker is operable.

- Liquids, such as water, coffee, or tea are able to be overheated beyond the boiling point without appearing to be boiling. Visible bubbling or boiling when the container is removed from the microwave oven is not always present. **THIS COULD RESULT IN VERY HOT LIQUIDS SUDDENLY BOILING OVER WHEN THE CONTAINER IS DISTURBED OR A SPOON OR OTHER UTENSIL IS INSERTED INTO THE LIQUID.**
-

To reduce the risk of injury to persons:

1. Do not overheat the liquid.
2. Stir the liquid both before and halfway through heating it.
3. Do not use straight-sided containers with narrow necks.
4. After heating, allow the container to stand in the microwave oven for a short time before removing the container.
5. Use extreme care when inserting a spoon or other utensil into the container.

SAVE THESE INSTRUCTIONS

Your New Microwave oven

Checking Parts

Unpack your microwave oven and check to make sure that you have all the parts shown here. If any part is missing or broken, call your dealer.



Microwave oven



Roller guide ring



Glass tray



Registration card



Instruction manual

Warranty and Service Information

To help us better serve you, please complete the enclosed registration card and promptly return it by mail. If the registration card is missing, you can call Samsung Electronics America, Inc., at 1-800-SAMSUNG(1-800-726-7864), or register on-line at WWW.SAMSUNGCANADA.COM

When contacting Samsung, please provide the specific model and serial number information which is usually located on the back or bottom of the product. Please record these numbers below, along with the other requested information. Keep this information in a safe place as a permanent record of your purchase to aid in identification in case of theft or loss, and a copy of your sales receipt as a proof of purchase if warranty service is needed.

MODEL NUMBER _____

SERIAL NUMBER _____

DATE PURCHASED _____

PURCHASED FROM _____

- Warranty service can only be performed by a Samsung Authorized Service Center. If you should require warranty service, provide the above information with a copy of your sales receipt to the Samsung Authorized Service Center.

For service assistance and the location of the nearest service center, please call 1-800-SAMSUNG (1-800-726-7864).

Your New Microwave oven

Setting Up Your Microwave Oven

- 1 Place the oven on a flat, sturdy surface and plug the cord into a grounded outlet. Once plugged in, the display on your oven will show:



Make sure there is adequate ventilation for your oven by leaving at least four inches of space behind, above, and to the sides of the oven.

- 2 Open the oven door by pulling the handle on the right side of the door.
- 3 Wipe the inside of the oven with a damp cloth.
- 4 Place the pre-assembled ring in the indentation in the center of the oven.

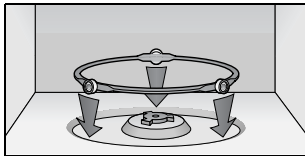

- 5 Place the glass tray on top of the ring so that the three glass tabs in the center of the tray fit securely into the tabs on the floor of the oven.

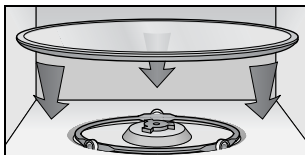

Control Panel Buttons

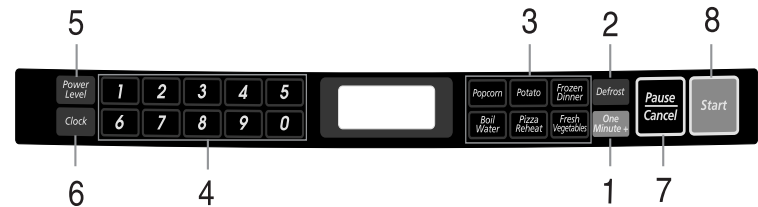

1. **One Minute+** p.8
Press once for every minute of cooking at High power.
2. **Defrost** p.8
Press to set the defrosting time of the food to be defrosted.
3. **Instant Cook Buttons** p.9
Instant settings to cook popular foods.
4. **Number buttons**
Sets cooking times.
5. **Power Level** p.10
Sets power to level other than high.
6. **Clock** p.7
Sets current time.
7. **Pause/Cancel** p.7
Press to pause oven or correct a mistake.
8. **Start**
Press to start cooking.

Operation

Setting the Clock

1 Press the **Clock** button. The display will show:



2 Use the **Number** buttons to enter the current time. You must press at least three numbers to set the clock. If the current time is 5:00 enter, 5,0,0:



3 Press **Clock** again. A colon will appear, indicating that the time is set.

If there is a power interruption, you will need to reset the clock.

*You can check the current time while cooking is in progress by pressing the **Clock** button.*

Using the Pause/Cancel Button

The **Pause/Cancel** button allows you to clear instructions you have entered. It also allows you to pause the oven's cooking cycle, so that you can check the food.

- To pause the oven during cooking: press **Pause/Cancel** once. To restart, press **Start**.
- To stop cooking, erase instructions, and return the oven display to the time of day: press **Pause/Cancel** twice.
- To Correct a mistake you have just entered: press **Pause/Cancel** once, then re-enter the instructions.

Operation

Using the One Minute+ Button

This button offers a convenient way to heat food in one-minute increments at the High power level.

- 1 Press the **One Minute+** button once for each minute you wish to cook the food. For example, press it twice for two minutes. The time will display, and the oven starts automatically.

*Add minutes to a program in progress by pressing the **One Minute+** button for each minute you want to add. You can only adjust the time during cooking when the time cook mode is selected.*

Defrosting

The defrost setting is designed for speedy thawing of frozen food and is one of the great advantages of the microwave oven. (Power level of 30% is automatically set for defrosting)

- 1 Press the **Defrost** button. The display shows "0".



- 2 Press the **Number** buttons to enter the desired defrosting time.
- 3 Press the **Start** button to begin defrosting.

- **See page 15 for the Defrosting Guide.**

Operation

Using the Instant Cook Buttons

- 1 Press the **Instant Cook** button corresponding to the food you are cooking (**Popcorn**, for example). The display shows the first serving size:



- 2 Press the button repeatedly to select the serving size you want. The display will cycle through all available serving sizes. Once you select the correct serving size, the microwave will begin cooking automatically.



Instant Cook Chart

Item	Weight	Remarks
Popcorn	3.5 oz 3.0-3.5 oz	<ul style="list-style-type: none">• Use one microwave-only bag of popcorn.• Use caution when removing and opening hot bag from oven• If it gets stuck, open the door and reposition the bag in the center of the oven, close the door and press start.
Potato	1 EA 2 EA 3 EA 4 EA	<ul style="list-style-type: none">• Prick each potato several times with a fork.• Place on turntable in spoke-like fashion.• Remove from oven, wrap in foil and let stand 3-5 min.• Once during cooking, the oven will beep to let you know to turn the food over. Turn the food over and then press start.
Frozen Dinner	8-10 oz 10-12 oz 12-14 oz	<ul style="list-style-type: none">• Remove package from outer wrapping and follow package instructions for covering and standing. After cooking, let stand 1-3 min.
Boil Water	½ cup 1 cup 2 cups	<ul style="list-style-type: none">• Measure liquid; pour into microwave-safe container that is 2 times larger than amount of liquid. Example: For 1 cup liquid use a 2 cup or larger dish.• Stir well before and after heating to prevent erupting.
Pizza Reheat	1 Slice 2 Slices 3 Slices 4 Slices	<ul style="list-style-type: none">• Put the pizza on a microwave-safe plate with wide end of slice towards the outside edge of the plate.• Do not let slices overlap. Do not cover.• Before serving, let stand 1-2 min.
Fresh Vegetables	1 cup 2 cups 3 cups 4 cups	<ul style="list-style-type: none">• Place the vegetable into a casserole bowl and add some water (2-4 Tbsp).• Cover during cooking and stir before standing.

Note

The cooking time of 3.0 oz. microwave-popcorn depends on the contents of butter and brands. Cooking time is adjustable for desired taste with numeric pads following package instructions.

Cooking Instructions

Time Cooking

One Stage Programming

The power level lets you control the heating intensity from Warm to High with the **Power Level** button.



- 1 Press the **Power Level** button. The power level is automatically set to high. If you want to set the power level to something other than High, press the **Power Level** button repeatedly.

Pad	Touch	Display	Output
Power Level	Once	PL:Hi	800W
	Twice	PL:90	720W
	3 Times	PL:80	640W
	4 Times	PL:70	560W
	5 Times	PL:60	480W
	6 Times	PL:50	400W
	7 Times	PL:40	320W
	8 Times	PL:30	240W
	9 Times	PL:20	160W
	10 Times	PL:10	80W

- 2 Press the **Number** buttons to enter the desired cooking time.
- 3 Press the **Start** button to begin cooking. If you want to change the power level, press Pause/Cancel before you press **Start**, and re-enter all of the instructions.

*You can check the Power Level while cooking is in progress by pressing the **Power Level** button.*

Two Stage Programming

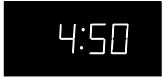
- 1 Touch **Defrost**.
Display window shows "0".

- 2 Enter defrosting time (up to 99 min. 99 sec.) by touching the number pads. For example, to set 3 minutes 50 seconds, touch 3, 5 and 0 in sequence. Display window shows "3:50".

- 3 Touch **Power Level**. For example, to set PL:Hi, touch the **Power Level** pad once. Display window shows "PL:Hi".

- 4 Enter cooking time (up to 99 min. 99 sec.) by touching the number pads.
For example, to set 4 minutes 50 seconds, touch 4, 5 and 0 in sequence. Display window shows "4:50".

- 5 Touch **Start**.
The first stage defrosting time appears in the display window and counts down. As soon as the defrosting finishes, the second stage cooking time appears automatically and counts down.

Cooking Instructions

Cooking Utensils

Recommended Use

- **Glass and glass-ceramic bowls and dishes** — Use for heating or cooking.
- **Microwave browning dish** — Use to brown the exterior of small items such as steaks, chops, or pancakes. Follow the directions provided with your browning dish.
- **Microwavable plastic wrap** — Use to brown the exterior of small opening for some steam to escape and avoid placing it directly on the food.
- **Wax paper** — Use as a cover to prevent spattering.
- **Paper towels and napkins** — Use for short-term heating and covering; they absorb excess moisture and prevent spattering. Do not use recycled paper towels, which may contain metal and can catch fire.
- **Paper plates and cups** — Use for short-term heating at low temperatures. Do not use recycled paper, which may contain metal and can catch fire.
- **Thermometers** — Use only those labeled "Microwave Safe" and follow all directions. Check the food in several places. Conventional thermometers may be used once the food has been removed from the oven.

Limited Use

- **Aluminum foil** — Use narrow strips of foil to prevent overcooking of exposed areas. Using too much foil can damage your oven, so be careful.
- **Ceramic, porcelain, and stoneware** — Use these if they are labeled "Microwave Safe." If they are not labeled, test them to make sure they can be used safely. Never use dishes with metallic trim.
- **Plastic** — Use only if labeled "Microwave Safe." Other plastics can melt.
- **Straw, wicker, and wood** — Use only for short-term heating, as they can be flammable.

Not Recommended

- **Glass jars and bottles** — Regular glass is too thin to be used in a microwave, and can shatter.
- **Paper bags** — These are a fire hazard, except for popcorn bags that are designed for microwave use.
- **Styrofoam plates and cups** — These can melt and leave an unhealthy residue on food.
- **Plastic storage and food containers** — Containers such as margarine tubs can melt in the microwave.
- **Metal utensils** — These can damage your oven. Remove all metal before cooking.

Testing Utensils

If you are not sure whether a dish is microwave-safe or not, you can perform this test:

- 1 Fill one measuring cup with water and put it inside your oven, next to the dish you want to test.

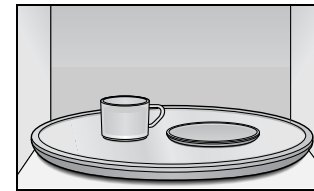

- 2 Press the **One Minute+** button once to heat them for one minute at High power.

The water should be warm and the dish you are testing should be cool. If the dish is warm, then it is absorbing microwave energy and is not acceptable for use in the microwave.

Cooking Instructions

Cooking Techniques

Stirring

Stir foods such as casseroles and vegetables while cooking to distribute heat evenly. Food at the outside of the dish absorbs more energy and heats more quickly, so stir from the outside to the center. The oven will turn off when you open the door to stir your food.

Arrangement

Arrange unevenly shaped foods, such as chicken pieces or chops, with the thicker, meatier parts toward the outside of the turntable where they receive more microwave energy. To prevent overcooking, place thin or delicate parts toward the center of the turntable.

Shielding

Shield food with narrow strips of aluminum foil to prevent overcooking. Areas that need shielding include poultry wing-tips, the ends of poultry legs, and corners of square baking dishes. Use only small amounts of aluminum foil. Larger amounts can damage your oven.

Turning

Turn foods over midway through cooking to expose all parts to microwave energy. This is especially important with large items such as roasts.

Standing

Foods cooked in the microwave build up internal heat and continue to cook for a few minutes after the oven stops. Let foods stand to complete cooking, especially foods such as roasts and whole vegetables. Roasts need this time to complete cooking in the center without overcooking the outer areas. All liquids, such as soup or hot chocolate, should be shaken or stirred when cooking is complete. Let liquids stand a moment before serving. When heating baby food, stir well and test the temperature before serving.

Adding Moisture

Microwave energy is attracted to water molecules. Food that is uneven in moisture content should be covered or allowed to stand so that the heat disperses evenly. Add a small amount of water to dry food to help it cook.

General Tips

- Dense foods, such as potatoes, take longer to heat than lighter foods. Foods with a delicate texture should be heated at a low power level to avoid becoming tough.
- Altitude and the type of cookware you are using can affect cooking time. When using a new recipe, use the minimum cooking time and check the food occasionally to prevent overcooking.
- Foods with a non-porous skin or shell, such as potatoes, eggs, or hot dogs, should be pierced to prevent bursting.
- Frying with heating oil or fat is not recommended. Fat and oil can suddenly boil over and cause severe burns.
- Some ingredients heat faster than others. For example, the jelly inside a jelly doughnut will be hotter than the dough. Keep this in mind to avoid burns.
- Home canning in the microwave oven is not recommended because all harmful bacteria may not be destroyed by the microwave heating process.
- Although microwaves do not heat the cookware, the heat is often transferred to the cookware. Always use pot holders when removing food from the microwave and instruct children to do the same.

Cooking Instructions

Cooking Guide

Guide for Cooking Meat in Your Microwave

- Place meat on a microwave-safe roasting rack in a microwave-safe dish.
- Start meat fat-side down. Use narrow strips of aluminum foil to shield any bone tips or thin meat areas.
- Check the temperature in several places before letting the meat stand the recommended time.
- The following temperatures are removal temperatures. The temperature of the food will rise during the standing time.

Food	Cook Time/Power Level	Directions
Roast Beef Boneless Up to 4 lbs.	Cooking Time: 5-8 min. / lb. for 115° F - Rare 6-9 min. / lb. for 120° F - Medium 7-12 min. / lb. for 145° F - Well Done <i>Power Level:</i> High(Hi) for first 5 min., then Medium(50).	Place roast fat-side down on roasting rack. Cover with wax paper. Turn over when cooking time is half up. Let stand 10 min.
Pork Boneless or bone-in Up to 4 lbs.	Cooking Time: 6-10 min. / lb. for 160° F - Well Done <i>Power Level:</i> High(Hi) for first 5 min., then Medium(50).	Place roast fat-side down on roasting rack. Cover with vented plastic wrap. Turn over when cooking time is half up. Let stand 10 min.
Bacon 2-6 slices	Cooking Time: 2 slices: 1½ - 2 min. 4 slices: 3 - 4 min. 6 slices: 4½ - 6min. <i>Power Level:</i> High(Hi).	Arrange slices on roasting rack or a dish lined with paper-towel. Cover with paper towel. Microwave until crisp.

Guide for Cooking Poultry in Your Microwave

- Place poultry on a microwave-safe roasting rack in a microwave-safe dish.
- Cover poultry with wax paper to prevent spattering.
- Use aluminum foil to shield bone tips, thin meat areas, or areas that start to overcook.
- Check the temperature in several places before letting the poultry stand the recommended time.

Food	Cook Time/Power Level	Directions
Whole Chicken Up to 4 lbs.	Cooking Time: 6-9 min. / lb. for 170° -180°F <i>Power Level:</i> High(Hi).	Place chicken breast-side down on roasting rack. Cover with wax paper. Turn over when cooking time is half up. Cook until juices run clear and meat near the bone is no longer pink. Let stand 5-10 min.
Chicken Pieces Up to 2 lbs.	Cooking Time: 4-7 min. / lb. for 180°F dark meat 170°F light meat <i>Power Level:</i> High(Hi).	Place chicken bone-side down on dish, with the thickest portions towards the outside of the dish. Cover with wax paper. Turn over when the cooking time is half up. Cook until juices run clear and meat near the bone is no longer pink. Let stand 5-10 min.

Cooking Instructions

Guide for Cooking Seafood in Your Microwave

- Cook fish until it flakes easily with a fork.
- Place fish on a microwave-safe roasting rack in a microwave-safe dish.
- Use a tight cover to steam fish. A lighter cover of wax paper or paper towel provides less steaming.
- Do not overcook fish; check it at minimum cooking time.

Food	Cook Time/Power Level	Directions
Steaks Up to 1.5 lbs.	Cooking Time: 4-7 min. / lb. <i>Power Level:</i> Medium-High(70).	Arrange steaks on roasting rack with meaty portions towards the outside of rack. Cover with wax paper. Turn over and rearrange when cooking time is half up. Cook until fish flakes easily with a fork. Let stand 3-5 min.
Fillets Up to 1.5 lbs.	Cooking Time: 2-5 min. / lb. <i>Power Level:</i> High(Hi).	Arrange fillets in a baking dish, turning any thin pieces under. Cover with wax paper. If over 1/2 inch thick, turn over and rearrange when cooking time is half up. Cook until fish flakes easily with a fork. Let stand 2-3 min.
Shrimp Up to 1.5 lbs.	Cooking Time: 3-5 min. / lb. <i>Power Level:</i> High(Hi).	Arrange shrimp in a baking dish without overlapping or layering. Cover with wax paper. Cook until firm and opaque, stirring 2 or 3 times. Let stand 5 min.

Guide for Cooking Eggs in Your Microwave

- Never cook eggs in the shell, and never warm hard-cooked eggs in the shell; they can explode.
- Always pierce whole eggs to keep them from bursting.
- Cook eggs just until set; they become tough if overcooked.

Guide for Cooking Vegetables in Your Microwave

- Vegetables should be washed just before cooking. Often, no extra water is needed. If dense vegetables such as potatoes, carrots and green beans are being cooked, add about ¼ cup water.
- Small vegetables (sliced carrots, peas, lima beans, etc.) will cook faster than larger ones.
- Whole vegetables, such as potatoes, a corn squash or corn on the cob, should be arranged in a circle on the turntable before cooking. They will cook more evenly if turned over after half the cooking time.
- Always place vegetables like asparagus and broccoli with the stem ends pointing towards the edge of the dish and the tips toward the center.
- When cooking cut vegetables, always cover the dish with a lid or vented microwavable plastic wrap.
- Whole, unpeeled vegetables such as potatoes, squash, eggplant, etc., should have their skin pricked in several spots before cooking to prevent them from bursting.
- For more even cooking, stir or rearrange whole vegetables halfway through the cooking time.
- Generally, the denser the food, the longer the standing time. (Standing time refers to the time necessary for dense, large foods and vegetables to finish cooking after they come out of the oven.) A baked potato can stand on the counter for five minutes before cooking is completed, while a dish of peas can be served immediately.

Cooking Instructions

Defrosting Guide

- Unwrap food. Place food on microwave-safe rack, plate or shallow dish.
- After first half of defrosting time: remove any remaining wrap, break food apart or separate pieces if possible, remove any thawed food, if possible, shield tips, thin meat or warm areas of food with foil.
- When defrosted, food should be cool, but softened in all areas. If still slightly icy, return to microwave oven very briefly, or let stand a few minutes.
- Poultry and fish may be placed under running cool water until defrosted.

Food	Microwave Time at Defrost Level	Directions
Beef		
Chuck Roast up to 5 lbs	Microwave Time: 7-9 min / lb Let Stand: 5-10 min.	Place on plate or rack. Microwave until a wooden pick can be easily inserted in center. Turn over twice.
Steaks up to 5 lbs	Microwave Time: 6-9 min / lb Let Stand: 5-10 min	Place on plate or rack. Microwave until pliable, then separate steaks and rearrange. Turn over twice.
Ground Beef up to 3 lbs	Microwave Time: 8-10 min / lb Let Stand: 5-10 min.	Place on plate or rack. Microwave until pliable, then break apart and remove defrosted portions at half time. Turn over twice.
Pork		
Spareribs up to 3 lbs	Microwave Time: 6-8 min / lb Let Stand: 5-10 min.	Place on plate or rack. Microwave until pliable, then separate and rearrange. Turn over twice.
Pork Chops up to 3 lbs	Microwave Time: 6-8 min / lb Let Stand: 5-10 min.	Place on plate or rack. Microwave until pliable, then separate and rearrange. Turn over twice.

Food	Microwave Time at Defrost Level	Directions
Poultry		
Whole Chicken up to 5 lbs	Microwave Time: 7-9 min / lb Let Stand: 5-10 min.	Place on plate or rack. Microwave until pliable, then break apart and rearrange portions at half time. Rinse cavity with cool water. Remove giblets.
Pieces up to 2 lbs	Microwave Time: 9-11 min / lb Let Stand: 5-10 min.	Place on plate or rack. Microwave until pliable, then break apart and rearrange portions at half time.
Seafood		
Steaks up to 3-5 lbs	Microwave Time: 6-9 min / lb Let Stand: 5-10 min.	Place on plate or rack. Microwave until a wooden pick can be easily inserted in center, break apart and rearrange at half time.
Fillets up to 3-5 lbs	Microwave Time: 4-7 min / lb Let Stand: 5-10 min.	Place on plate or rack. Microwave until a wooden pick can be easily inserted in center, break apart and rearrange at half time.
Shrimp up to 3 lbs	Microwave Time: 4-7 min / lb Let Stand: 5-10 min.	Place on plate or rack. Microwave until pliable, then separate and rearrange at half time.

Cooking Instructions

Recipes

Beef and Barley Stew

1½ lbs. beef stew cubes, cut into ½-inch pieces

½ cup chopped onion

2 Tbs. all-purpose flour

1 Tbs Worcestershire sauce

1 can (13.75-14.5 oz.) beef broth

2 medium carrots, cut into ½-inch slices (about 1 cup)

½ cup barley

1 bay leaf

¼ tsp. pepper

1 pkg. (9-10 oz.) frozen peas, thawed

1. In a 2-quart casserole, combine beef, onion, flour, and Worcestershire; mix well. Cover with lid. Cook at High for 6 to 8 minutes until beef is no longer pink, stirring once.
2. Stir in beef broth, carrots, barley, bay leaf, and pepper. Cover with lid. Cook at Medium for 45 to 50 minutes until carrots and beef are tender, stirring 2 to 3 times.
3. Stir in peas. Cover with lid. Cook at Medium for 10 minutes. Let stand for 10 minutes. Remove bay leaf before serving.

Makes 6 servings.

Broccoli and Cheese Casserole

¼ cup butter or margarine

¼ cup chopped onion

1½ Tbs. flour

½ tsp. salt

¼ tsp. dry mustard

⅛ tsp. pepper

1½ cups milk

- ¼ cup chopped red pepper

8 oz. (2 cups) cheddar cheese, shredded

1 pkg. (9-10 oz.) frozen chopped broccoli, thawed

4 cups cooked spiral shaped pasta (8 oz. dry)

1. In a 2-quart casserole, cook butter and onion at High for 2 to 3 minutes until onion is soft, stirring once.
2. Add flour, salt, mustard, and pepper; mix well. Cook at High for 60 to 90 seconds until mixture boils. Stir in milk until smooth.
3. Stir in red pepper. Cook at High for 2 to 3 minutes until mixture boils and thickens slightly, stirring twice. Stir in cheese until melted.
- 4. Add broccoli and pasta, mix well. Cover with lid. Cook at High for 4 to 6 minutes until heated through, stirring once. Stir before serving.

Makes 6 servings.

Cooking Instructions

Warm Potato Salad

2 lbs. small red potatoes, cut into ½-inch pieces
4 slices bacon (uncooked), cut into ½-inch pieces
¼ cup chopped onion
2 tsp. sugar
1 tsp. salt
1 tsp. flour
½ tsp. celery seed
⅛ tsp. pepper
2½ Tbs. apple cider vinegar

1. In a 2-quart casserole, combine potatoes and ¼ cup water. Cover with lid. Cook at High until potatoes are tender (10-12 min.); stir twice. Drain and set aside to cool slightly.
2. In a medium bowl, cook bacon at High until crisp (3-5 min.); stir once. Place bacon on a paper towel. Reserve 1 Tbs. drippings.
3. Combine drippings and onion. Cover with plastic wrap; turn back a corner to vent steam. Cook at High until tender (3-4 min.); stir once.
4. Stir in sugar, salt, flour, celery seed, and pepper. Cook at High until mixture boils (30-40 sec.). Stir in vinegar and ½ cup water. Cook at High until liquid boils and thickens slightly (1-2 min.); stir once. Add bacon to dressing. Pour dressing over potatoes. Stir well.

Makes 6 servings.

Black Bean Soup

1 cup chopped onion
1 clove garlic, minced
2 cans (15 oz. each) black beans, drained
1 can (14-16 oz.) stewed tomatoes, chopped
1 can (13.75-14.5 oz.) chicken broth
1 can (7-8.5 oz.) corn
1 can (4 oz.) chopped green chilies
• 1-2 tsp. ground cumin, or to taste

1. Place onion and garlic in a 3-quart casserole. Cover with lid. Cook at High for 3 to 5 minutes until tender.
2. Add one can of beans, mash beans with a fork. Add remaining ingredients; mix well.
3. Cook uncovered, at High for 10 minutes; stir. Reduce power to Medium and cook for 5 minutes. Stir before serving.

Makes about 2 quarts.

Appendix

Troubleshooting Guide

Before you call a repair person for your oven, check this list of possible problems and solutions.

Neither the oven's display nor the oven operate.

- Properly insert the plug into a grounded outlet.
- If the outlet is controlled by a wall switch, make sure the wall switch is turned on.
- Remove the plug from the outlet, wait ten seconds, then plug it in again.
- Reset the circuit breaker or replace any blown fuse.
- Plug another appliance into the outlet; if the other appliance doesn't work, have a qualified electrician repair the outlet.
- Plug the oven into a different outlet.

The oven's display works, but the power won't come on.

- Make sure the door is closed securely.
- Check to see if packing material or other material is stuck to the door seal.
- Check for door damage.
- Press Cancel twice and re-enter all cooking instructions.

The power goes off before the set time has elapsed.

- If there has not been a power outage, remove the plug from the outlet, wait ten seconds, then plug it in again. If there was a power outage, the time indicator will display "00:00". Reset the clock and any cooking instructions.
- Reset the circuit breaker or replace any blown fuse.

The food is cooking too slowly.

- Make sure the oven is on its own 15 amp circuit line. Operating another appliance on the same circuit can cause a voltage drop. If necessary, move the oven to its own circuit.

You see sparks or arcing.

- Remove any metallic utensils, cookware, or metal ties. If using foil, use only narrow strips and allow at least one inch between the foil and interior oven walls.

The turntable makes noises or sticks.

- Clean the turntable, roller ring and oven floor.
- Make sure the turntable and roller ring are positioned correctly.

Using your microwave causes TV or radio interference.

- This is similar to the interference caused by other small appliances, such as hair dryers. Move your microwave further away from other appliances, like your TV or radio.

Note :

If the oven is set more than 25 minutes at 80, 90 or 100 percent power level, after the first 25 minutes the power level will automatically adjust itself to 70 percent power approximately to avoid overcooking.

Care and Cleaning

Follow these instructions to clean and care for your oven.

- Keep the inside of the oven clean. Food particles and spilled liquids can stick to the oven walls, causing the oven to work less efficiently.
- Wipe up spills immediately. Use a damp cloth and mild soap. Do not use harsh detergents or abrasives.
- To help loosen baked on food particles or liquids, heat two cups of water (add the juice of one lemon if you desire to keep the oven fresh) in a four-cup measuring glass at High power for five minutes or until boiling. Let stand in the oven for one or two minutes.
- Remove the glass tray from the oven when cleaning the oven or tray. To prevent the tray from breaking, handle it carefully and do not put it in water immediately after cooking. Wash the tray carefully in warm sudsy water or in the dishwasher.
- Clean the outside surface of the oven with soap and a damp cloth. Dry with a soft cloth. To prevent damage to the operating parts of the oven, don't let water seep into the openings.
- Wash the door window with very mild soap and water. Be sure to use a soft cloth to avoid scratching.
- If steam accumulates inside or outside the oven door, wipe with a soft cloth. Steam can accumulate when operating the oven in high humidity and in no way indicates microwave leakage.
- Never operate the oven without food in it, this can damage the magnetron tube or glass tray. You may wish to leave a cup of water in the oven when it is not in use to prevent damage if the oven is accidentally turned on.

**If you have a problem you cannot solve,
please call our service line:**

1-800-SAMSUNG (1-800-726-7864)

Appendix

Specifications

Model Number	MD800
Controls	10 power levels, including defrost
Timer	99 minutes, 99 seconds
Power Source	120 VAC, 60 Hz
Power Output	800 Watts (ICE-705 TEST PROCEDURE)
Outside Dimensions	16 ^{19/32"} (W) X 17 ^{11/64"} (H) X 12 ^{37/64"} (D)
Oven Cavity Dimensions	12 ^{61/64"} (W) X 12 ^{11/64"} (H) X 7 ^{53/64"} (D)
Net/Gross Weight	30.1 lbs /33.3 lbs

Warranty Information

Limited Warranty for Original Purchaser

This Samsung product is warranted by Samsung Electronics Canada, Inc. (hereafter referred to as SECA) against manufacturing defects in material or workmanship for the following periods:

Labor: 1 year (carry-in)

Parts: 1 year

Magnetron: 5 years

SECA further warrants that if this product fails to operate properly within the specified warranty period and the failure is due to improper workmanship or defective material, SECA will repair or replace the product at its option.

All warranty repairs or part replacements must be performed by a SECA Authorized Service Center. (To find the nearest SECA Service Center, call 1-800-SAMSUNG.)

Obligation to the Original Owner

The original dated sales receipt must be retained by the customer and is the only acceptable proof of purchase. It must be presented to an SECA Authorized Service Center at the time service is requested before warranty services are rendered. On all carry-in models, transportation to and from the Authorized Service Center is the responsibility of the customer.

Exclusions of the Warranty

This warranty does not cover damage due to accident, fire, flood, and/or other Acts of God: misuse, incorrect line voltage, improper installation, improper or unauthorized repairs, commercial use, or damage that occurs during shipping. Customer adjustments which are explained in this owner's manual are not covered under the terms of this warranty.

This warranty will automatically be voided for any unit found with a missing or altered serial number. This warranty is valid only on products purchased and used in the Canada.

SAMSUNG ELECTRONICS

NORTH AMERICAN LIMITED WARRANTY ADDENDUM

Subject to the requirements, conditions, exclusions and limitations of the Original Limited Warranty supplied with Samsung Electronics (SAMSUNG) products, and the requirements, conditions, exclusions and limitations contained herein, SAMSUNG will additionally provide Warranty Repair Service in the United States on SAMSUNG products purchased in Canada, and in Canada on SAMSUNG products purchased in the United States, for the warranty period originally specified, and to the Original Purchaser only.

- The above described warranty repairs must be performed by a SAMSUNG Authorized Service Center. Along with this Statement, the Original Limited Warranty Statement and a dated Bill of Sale as Proof of Purchase must be presented to the Service Center. Transportation to and from the Service Center is the responsibility of the purchaser.

Conditions covered are limited only to manufacturing defects in material or workmanship, and only those encountered in normal use of the product.

- Excluded, but not limited to, are any original specified provisions for, inhome or on-site services, minimum or maximum repair times, exchanges or replacements, accessories, options, upgrades, or consumables.

For the locations of a SAMSUNG Authorized Service Center in the United States and Canada, please contact SAMSUNG at:

1-800-SAMSUNG (1-800-726-7864)

Or on-line at: WWW.SAMSUNGUSA.COM
and WWW.SAMSONGCANADA.COM

Quick Reference

Feature	Operation
Set Clock	<ol style="list-style-type: none">1. Press CLOCK.2. Use the Number buttons to enter the current time.3. Press CLOCK again.
One Minute+ Cooking	<ol style="list-style-type: none">1. Press the ONE MINUTE + button once for each minute of cooking.2. The time will display and the oven will start.
Instant Cook Buttons	<ol style="list-style-type: none">1. Press button that corresponds to the food you are cooking (for example, POPCORN).2. Press the button repeatedly to select serving size.
Defrost	<ol style="list-style-type: none">1. Press DEFROST.2. Press the buttons(0-9) sequentially to enter the desired defrosting time.3. Press START.
Set Cooking Time and Power Levels	<ol style="list-style-type: none">1. Press the POWER LEVEL button. If you want to set the power level to something other than High, press the POWER LEVEL button repeatedly.2. Use NUMBER buttons to set cooking time.3. Press START to begin cooking.



ELECTRONICS

SAMSUNG ELECTRONICS CANADA, INC.
7037 FINANCIAL DRIVE,
MISSISSAUGA,
ONTARIO, L5N 6R3

Samsung Electronics Co., Ltd.
Printed in Malaysia

Free Manuals Download Website

<http://myh66.com>

<http://usermanuals.us>

<http://www.somanuals.com>

<http://www.4manuals.cc>

<http://www.manual-lib.com>

<http://www.404manual.com>

<http://www.luxmanual.com>

<http://aubethermostatmanual.com>

Golf course search by state

<http://golfingnear.com>

Email search by domain

<http://emailbydomain.com>

Auto manuals search

<http://auto.somanuals.com>

TV manuals search

<http://tv.somanuals.com>