



Microwave Oven

Owner's Manual

MW1040WC/BC
MW1240WC/BC
MW1440WC/BC
ME1240SC
ME1440SC
ME1280STC
ME1480STC



ME1480STC



MW1040WC/BC/MW1240WC/BC/
MW1440WC/BC
ME1240SC/ME1440SC



ME1280STC

Code No.: DE68-02612A

Safety

PRECAUTIONS TO AVOID POSSIBLE EXPOSURE TO EXCESSIVE MICROWAVE ENERGY:

- (a) Do not attempt to operate this oven with the door open since open-door operation can result in harmful exposure to microwave energy. It is important not to defeat or tamper with the safety interlocks.
- (b) Do not place any object between the oven front face and the door or allow soil or cleaner residue to accumulate on sealing surfaces.
- (c) Do not operate the oven if it is damaged. It is particularly important that the oven door close properly and that there is no damage to the
 - 1) Door (bent or dented),
 - 2) Hinges and latches (broken or loosened),
 - 3) Door seals and sealing surfaces.
- (d) The oven should not be adjusted or repaired by anyone except properly qualified service personnel.

WARNING

Always observe Safety Precautions when using your oven. Never try to repair the oven on your own – there is dangerous voltage inside. If the oven needs to be repaired, call 1-800-SAMSUNG for the name of an authorized service center near you.

IMPORTANT SAFETY INSTRUCTIONS

When using any electrical appliance, basic safety precautions should be followed, including the following:

WARNING

To reduce risk of burns, electric shock, fire, personal injury or exposure to excessive microwave energy:

- Read all safety instructions before using the appliance.
- Read and follow the specific “**PRECAUTIONS TO AVOID POSSIBLE EXPOSURE TO EXCESSIVE MICROWAVE ENERGY**” on this page.
- This appliance must be grounded. Connect only to properly grounded outlets. See “**IMPORTANT GROUNDING INSTRUCTIONS**” on page 4 of this manual.
- Install or place this appliance only in accordance with the installation instructions provided.
- Some items, like whole eggs and food in sealed containers, may explode if heated in this oven.
- Use this appliance only for its intended use as described in the manual. Do not use corrosive chemicals or vapors in this appliance. This type of oven is specifically designed to heat, cook, or dry food. It is not designed for industrial or laboratory use.
- As with any appliance, close supervision is necessary when used by children.
- Do not operate this appliance if it has a damaged cord or plug, if it is not working properly, or if it has been damaged.
- This appliance should be serviced only by qualified service personnel. Contact the nearest authorized service facility for examination, repair, or adjustment.
- Do not cover or block any of the openings on this appliance.

SAVE THESE INSTRUCTIONS

Safety

Important Safety Instructions, continued

- Do not store this appliance outdoors. Do not use near water – for example, near a kitchen sink, in a wet basement, or near a swimming pool, etc.
- Keep the inside of the oven clean. Food particles or spattered oils stuck to the oven walls or floor can cause paint damage and reduce the efficiency of the oven.
- Do not immerse cord or plug in water.
- Keep cord away from heated surfaces.
- Do not let cord hang over edge of table or counter.
- When cleaning door and oven surfaces, use only mild, nonabrasive soaps or detergents applied with a sponge or soft cloth.
- To reduce the risk of fire in the oven:
 - a. Do not overcook food. Watch appliance carefully if paper, plastic, or other combustible materials are inside.
 - b. Remove wire twist-ties from plastic cooking bags before placing bags in oven.
 - c. If materials inside the oven ignite, keep the oven door closed, turn the oven off, disconnect the power cord, or shut off the power at the fuse or circuit breaker panel. If the door is opened, the fire may spread.
 - d. Do not use the oven compartment for storage purposes. Do not leave paper products, cooking utensils, or food in the oven when not in use.
- Do not try to preheat oven or operate while empty.
- Do not cook without the glass tray in place on the oven floor. Food will not cook properly without the tray.
- Do not defrost frozen beverages in narrow-necked bottles. The containers can break.
- Dishes and containers can become hot. Handle with care.
- Carefully remove container coverings, directing steam away from hands and face.
- Remove lids from baby food before heating. After heating baby food, stir well and test temperature by tasting before serving.
- Do not operate any other heating or cooking appliance beneath this appliance.
- Do not mount unit over or near any portion of a heating or cooking appliance.
- Do not mount over a sink.
- Do not store anything directly on top of the appliance when it is in operation.
- Precaution for safe use to avoid possible exposure to excessive microwave oven energy:
 - Do not attempt to pull any part of the door by hand to open the door. Open the door only utilizing the push button located at front-right-bottom side. (except ME1280STC, ME1480STC)

SAVE THESE INSTRUCTIONS

Safety

IMPORTANT GROUNDING INSTRUCTIONS

This appliance must be grounded. In the event of an electrical short circuit, grounding reduces the risk of electric shock by providing an escape wire for the electrical current. This appliance is equipped with a cord that includes a grounding wire and a grounding plug. The plug must be plugged into an outlet that is properly installed and grounded. Plug the three-prong power cord into a properly grounded outlet of standard 115-120 voltage, 60 Hz. Your oven should be the only appliance on this circuit.

WARNING

Improper use of the grounding plug can result in a risk of electric shock. Consult a qualified electrician or servicer if you do not understand the grounding instructions or if you are not sure if the appliance is properly grounded.

Use of Extension Cords

A short power-supply cord is provided to reduce the risk of becoming entangled in or tripping over a longer cord. Longer cord sets or extension cords are available and may be used if care is exercised in their use. If a long cord or extension cord is used:

- 1. The marked electrical rating of the cord set or extension cord should be at least as great as the electrical rating of the appliance.
- 2. The extension cord must be a grounding-type 3-wire cord and it must be plugged into a 3-slot outlet.
- 3. The longer cord should be arranged so that it will not drape over the counter top or tabletop where it can be pulled on by children or tripped over accidentally. If you use an extension cord, the interior light may flicker and the blower may vary when the microwave oven is on. Cooking times may be longer, too.

WARNING

Do not cut or remove the third (ground) prong from the power cord under any circumstances.

Note

Connect the oven to a 20A circuit. When connecting the oven to a 15A circuit, make sure that circuit breaker is operable.

SAVE THESE INSTRUCTIONS

Your New Microwave oven

Checking Parts

Unpack your microwave oven and check to make sure that you have all the parts shown here. If any part is missing or broken, call your dealer.

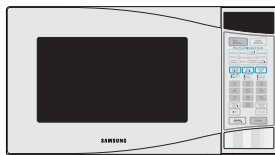

Microwave oven



Roller guide ring



Registration card



Glass tray



Instruction manual

Warranty and Service Information

To help us better serve you, please complete the enclosed registration card and promptly return it by mail. If the registration card is missing, you can call Samsung Electronics America, Inc., at 1-800-SAMSUNG(1-800-726-7864), or register on-line at WWW.SAMSUNGUSA.COM

When contacting Samsung, please provide the specific model and serial number information which is usually located on the back or bottom of the product. Please record these numbers below, along with the other requested information. Keep this information in a safe place as a permanent record of your purchase to aid in identification in case of theft or loss, and a copy of your sales receipt as a proof of purchase if warranty service is needed.

MODEL NUMBER _____

SERIAL NUMBER _____

DATE PURCHASED _____

PURCHASED FROM _____

Warranty service can only be performed by a Samsung Authorized Service Center. If you should require warranty service, provide the above information with a copy of your sales receipt to the Samsung Authorized Service Center.

For service assistance and the location of the nearest service center, please call 1-800-SAMSUNG (1-800-726-7864), or go on-line to WWW.SAMSUNG-SUPPORT.COM

Setting Up Your Microwave Oven

- 1 Place the oven on a flat, sturdy surface and plug the cord into a grounded outlet. Once plugged in, the display on your oven will show:



Make sure there is adequate ventilation for your oven by leaving at least four inches of space behind, above, and to the sides of the oven.

- 2 Open the oven door.
- 3 Wipe the inside of the oven with a damp cloth.
- 4 Place the pre-assembled ring in the indentation in the center of the oven.

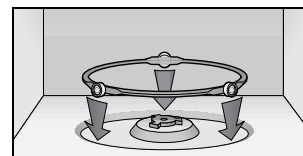

- 5 Place the glass tray on top of the ring so that the three glass tabs in the center of the tray fit securely into the tabs on the floor of the oven.

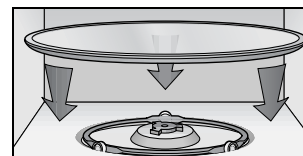

Your New Microwave oven

Control Panel Buttons (MW1040WC/BC)

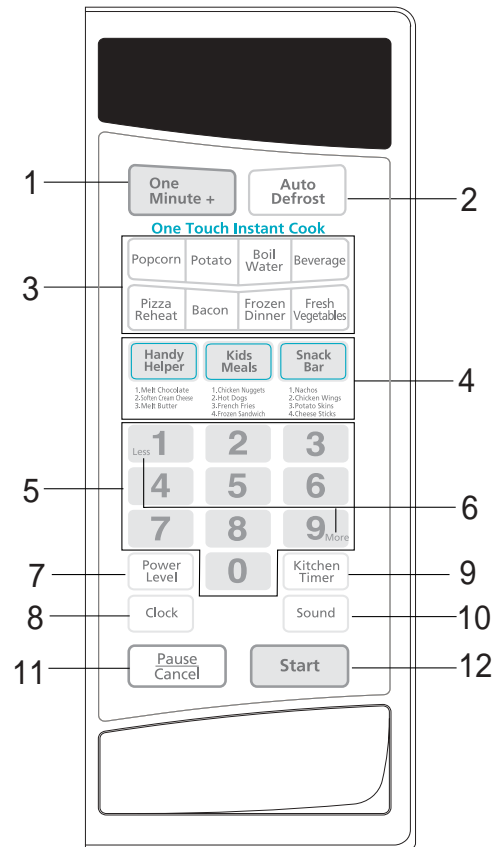

- | | |
|--|------------------|
| 1. One Minute + | 8. Clock |
| 2. Auto Defrost | 9. Kitchen Timer |
| 3. Instant Cook Buttons | 10. Sound |
| 4. Handy Helper, Kids Meals, Snack Bar | 11. Pause/Cancel |
| 5. Number Buttons | 12. Start |
| 6. More/Less | |
| 7. Power Level | |

MW1240WC/BC, ME1240SC

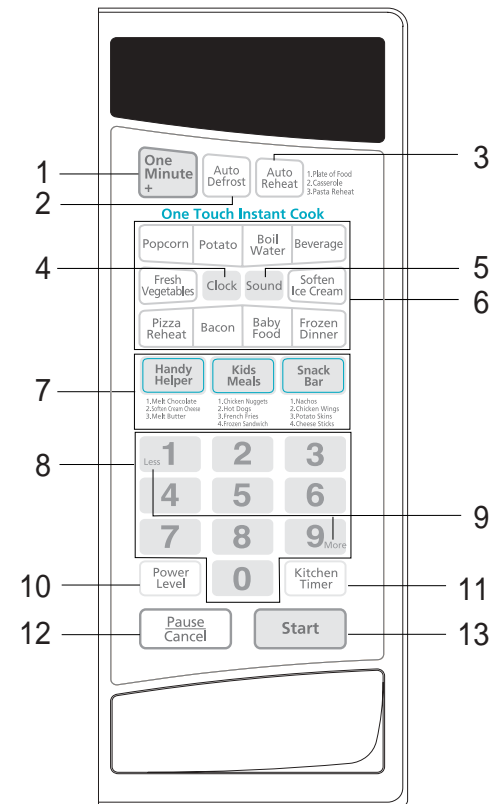

- | | |
|--|-------------------|
| 1. One Minute + | 8. Number Buttons |
| 2. Auto Defrost | 9. More/Less |
| 3. Auto Reheat | 10. Power Level |
| 4. Clock | 11. Kitchen Timer |
| 5. Sound | 12. Pause/Cancel |
| 6. Instant Cook Buttons | 13. Start |
| 7. Handy Helper, Kids Meals, Snack Bar | |

Your New Microwave oven

MW1440WC/BC, ME1440SC

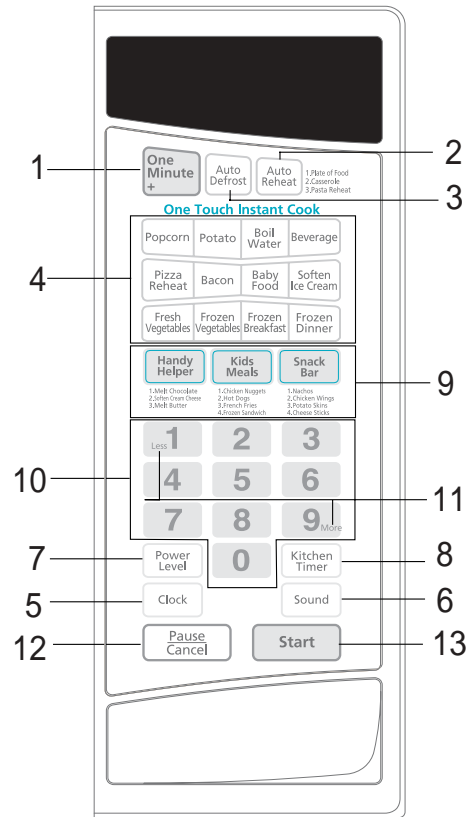

- | | |
|-------------------------|--|
| 1. One Minute + | 9. Handy Helper, Kids Meals, Snack Bar |
| 2. Auto Reheat | 10. Number Buttons |
| 3. Auto Defrost | 11. More/Less |
| 4. Instant Cook Buttons | 12. Pause/Cancel |
| 5. Clock | 13. Start |
| 6. Sound | |
| 7. Power Level | |
| 8. Kitchen Timer | |

ME1280STC

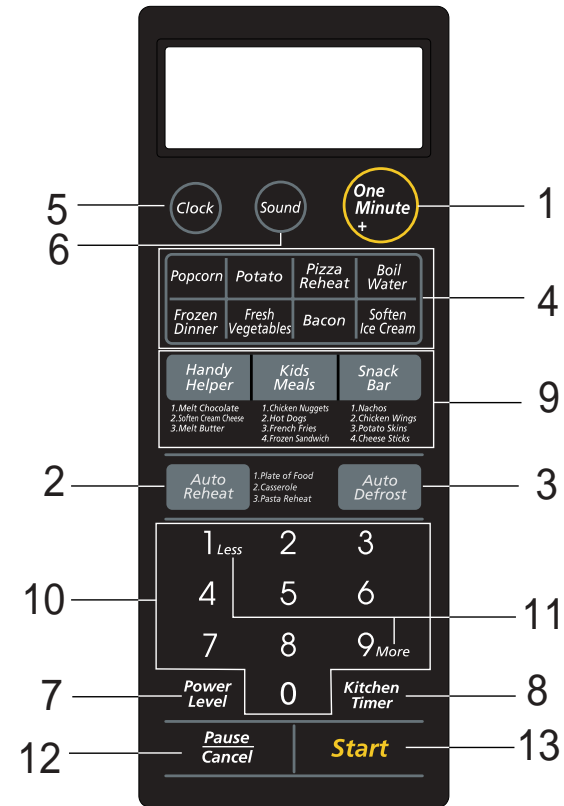

- | | |
|-------------------------|--|
| 1. One Minute + | 9. Handy Helper, Kids Meals, Snack Bar |
| 2. Auto Reheat | 10. Number Buttons |
| 3. Auto Defrost | 11. More/Less |
| 4. Instant Cook Buttons | 12. Pause/Cancel |
| 5. Clock | 13. Start |
| 6. Sound | |
| 7. Power Level | |
| 8. Kitchen Timer | |

Your New Microwave oven

ME1480STC

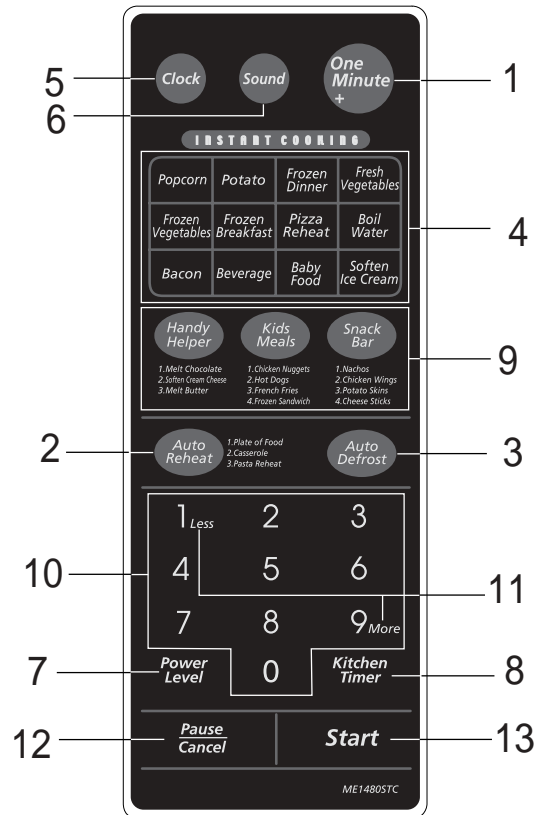

- | | |
|-------------------------|--|
| 1. One Minute + | 9. Handy Helper, Kids Meals, Snack Bar |
| 2. Auto Reheat | 10. Number Buttons |
| 3. Auto Defrost | 11. More/Less |
| 4. Instant Cook Buttons | 12. Pause/Cancel |
| 5. Clock | 13. Start |
| 6. Sound | |
| 7. Power Level | |
| 8. Kitchen Timer | |

Table of Contents

Safety	2
Your New Microwave oven	5
Checking Parts	5
Warranty and Service Information	5
Setting Up Your Microwave Oven	5
Control Panel Buttons	6-8
Table of Contents	8
Operation	9
Turning on the Power and Selecting a Weight	9
Setting the Clock	9
Using the Pause/Cancel Button	9
Using the One Minute + Button	9
Using the Instant Cook Buttons	9
Using the Handy Helper Button	10
Using the Kids Meals Button	11
Using the Snack Bar Button	11
Reheating Automatically (MW1240/1440, ME1240/1440/1280/1480)	12
Defrosting Automatically	12
Setting Cooking Times & Power Levels	13
One-stage Cooking	13
Multi-stage Cooking	13
Demonstration Mode	13
Using the More/Less Buttons	13
Switching the Beeper On/Off	13
Using the Kitchen Timer	13
Setting the Child Protection Lock	13
Cooking Instructions	14
Cooking Utensils	14
Testing Utensils	14
Cooking Techniques	15
General Tips	15
Cooking Guide	16-17
Auto Defrosting Guide	17
Recipes	18
Appendix	19
Troubleshooting Guide	19
Care and Cleaning	19
Specifications	20-21
Warranty	21
Warranty Information	21-22
Guía de Consulta Rápida en Español(Spanish)	23
Quick Reference(English)	Back Cover

Operation

Turning on the Power and Selecting a Weight

The first time you plug the power cord into an outlet, or after there has been an interruption in power, the display shows "00:00". At this point, you can select the weight system for the display. You can choose between pounds (LBS) or kilograms (KG). To do so,

- 1 Press **0** immediately after plugging in your microwave. The display will show:



If the display does not show "Kg", you will need to unplug the microwave and then plug it in again in order to change to the weight selection.

- 2 Press **0** repeatedly to select the weight system you wish to use:



When you have selected the weight system you want to use, press the **PAUSE/CANCEL** button to end this procedure.

Setting the Clock

- 1 Press the **Clock** button. The "ENTER" and "TIME" indicators flash.
- 2 Use the number buttons to enter the current time. You must press at least three numbers to set the clock. If the current time is 5:00 enter, 5,0,0.
- 3 When 5 seconds has elapsed, "ENTER" indicator flash and "Cloc" will be displayed.
- 4 Press **Clock** again. A colon will blink, indicating that the time is set.

If there is a power interruption, you will need to reset the clock.

You can check the current time while cooking is in progress by pressing the **Clock** button.

Using the Pause/Cancel Button

The **Pause/Cancel** button allows you to clear instructions you have entered. It also allows you to pause the oven's cooking cycle, so that you can check the food.

- To pause the oven during cooking: press **Pause/Cancel** once. To restart, press **Start**.
- To stop cooking, erase instructions, and return the oven display to the time of day: press **Pause/Cancel** twice.
- To correct a mistake you have just entered: press **Pause/Cancel** once, then re-enter the instructions.

Using the One Minute + Button

This button offers a convenient way to heat food in one minute increments at the High power level.

- 1 Press the **One Minute+** button once for each minute you wish to cook the food. For example, press it twice for two minutes. The time will display, and the oven starts automatically.

Add minutes to a program in progress by pressing the **One Minute+** button for each minute you want to add.

Using the Instant Cook Buttons

- 1 Press the **Instant Cook** button corresponding to the food you are cooking (**Beverage**, for example). The display shows the first serving size. ("ENTER" and "QTY." will flash):
- 2 Press the button repeatedly to select the serving size you want. The display will cycle through all available serving sizes. Once you select the correct serving size, the microwave will begin cooking automatically.

When the cooking time is over, the oven will beep. The oven will then beep every minute.

Item	Weight	Remarks
Beverage (except ME1280)	½ cup 1 cup 2 cups	<ul style="list-style-type: none"> • Use measuring cup or mug ; do not cover. • Place the beverage in the oven. • After heating, stir well.
Popcorn	3.5 oz 3.0-3.5 oz	<ul style="list-style-type: none"> • Use one microwave-only bag of popcorn. • Use caution when removing and opening hot bag from oven. • To help prevent the popcorn bag from getting stuck in the oven, fold each end of the bag up one inch (👉) before placing the bag in the center of the oven. • If it still gets stuck, open the door and reposition the bag, close the door and press start.
Fresh Vegetables	1 cup 2 cups 3 cups 4 cups	<ul style="list-style-type: none"> • Place the vegetable into a casserole and add some water. • Cover during cooking and stir before standing.
Frozen Dinner	8-10 oz 10-12 oz	<ul style="list-style-type: none"> • Remove package from outerwrapping and follow package instructions for covering and standing. After cooking, let stand 1-3 min.

Operation

Item	Weight	Remarks
Potato	1 EA 2 EA 3 EA 4 EA	<ul style="list-style-type: none"> Prick each potato several times with fork. Place on turntable in spoke-like fashion. Remove from oven, wrap in foil and let stand 3-5 min. Once during cooking, the oven will beep to let you know to turn the food over.
Boil Water	½ cup 1 cup 2 cups	<ul style="list-style-type: none"> Measure liquid; pour into microwave-safe container that is 2 times larger than amount of liquid. Example: For 1 cup liquid use a 2 cup or larger dish. Stir well before and after heating to prevent erupting.
Bacon	2 Slices 4 Slices 6 Slices	<ul style="list-style-type: none"> Place 2 paper towels on plate and arrange bacon on towels, do not overlap. Cover with additional paper towel. Remove paper towel immediately after cooking. Use More or Less button for desired crispness.
Frozen Vegetables (MW1440, ME1440, ME1480)	1 serving 2 servings 3 servings 4 servings	<ul style="list-style-type: none"> Remove from package. Place the vegetables into a casserole bowl and add a small amount of water (2-4Tbsp). Cover during cooking and stir before standing.
Frozen Breakfast (MW1440, ME1440, ME1480)	2-4 oz (MW1440 only) 4-6 oz 6-8 oz	<ul style="list-style-type: none"> Remove package from outer wrapping and follow package instructions for covering and standing. After cooking, let stand 1-3 min.
Baby food (MW1240,1440, ME1240,1440 ME1480)	2.5 oz 4 oz 6 oz	<ul style="list-style-type: none"> Remove lid from baby food and place in the center of oven. Check temperature and stir well before serving. The More/Less key cannot be used with the baby food key.
Soften Ice Cream (except 1040)	1 pint ½ gallon	<ul style="list-style-type: none"> Remove top of carton. Place carton in center of microwave oven. Let stand 2 min. after microwaving.
Pizza Reheat	1 Slice 2 Slices 3 Slices 4 Slices	<ul style="list-style-type: none"> Put the pizza on a microwave-safe plate with wide end of slice towards the outside edge of the plate. Do not let slices overlap. Do not cover. Before serving, let stand 1-2 min.

Using the Handy Helper Button

- Press the **Handy Helper** button corresponding to the food you are cooking. The display shows "A-1".(item code)
Press the **Handy Helper** button repeatedly to select the item you want.(Refer to the **Handy Helper Chart** below)
- Press the **Number** "1" or "2" button to select the serving size you want. Only the "1" button(serving) is available to Soften Cream Cheese and Melt Chocolate.(Refer to the **Handy Helper Chart** below for the serving)
- Press **Start** button to begin cooking.

Handy Helper Chart

Item	Code	Weight	Remarks
Melt Chocolate	A-1	1 cup chips	<ul style="list-style-type: none"> Place chocolate chips in a microwave-safe dish. Stir well at half time when the oven beeps, and re-start the oven. Unless stirred, the chocolate keeps its shape even when heating time is over.
Soften Cream Cheese	A-2	1 package (8 oz.)	<ul style="list-style-type: none"> Unwrap cream cheese and place on microwave-safe dish. Let stand 1-2 min.
Melt Butter	A-3	1 stick (1/4 lb.) 2 sticks (1/2 lb.)	<ul style="list-style-type: none"> Remove wrapping and cut butter in half vertically. Place butter in dish, cover with wax paper. Stir well after finishing and let stand 1-2 min.

Operation

Using the Kids Meals Button

- 1 Press the **Kids Meals** button corresponding to the food you are cooking. The display shows "A-1"(item code).
Press the **Kids Meals** button repeatedly to select the item you want.(Refer to the **Kids Meals Chart** below)
- 2 Press the **Number 1** or **2** button to select the serving size you want. (Refer to the **Kids Meals Chart** below for the serving.)
- 3 Press **Start** button to begin cooking.

Kids Meals Chart

Item	Code	Weight	Remarks
Chicken Nuggets	A-1	4-5 oz 6-7 oz	<ul style="list-style-type: none"> • Put a paper towel on top of plate and arrange nuggets in spoke fashion on paper towel. • Do not cover. Let stand 1 min.
Hot Dogs	A-2	2 EA 4 EA	<ul style="list-style-type: none"> • Prick hot dogs, place on plate. When the oven beeps, add buns and re-start the oven.
French Fries	A-3	4-5 oz 6-7 oz	<ul style="list-style-type: none"> • Place 2 paper towels on plate and arrange french fries on towels, do not overlap. • Blot with additional paper towel after removal from oven.
Frozen Sandwich	A-4	1 EA 2 EA	<ul style="list-style-type: none"> • Place frozen sandwich in susceptor "sleeve" (which is in package) and put on plate.

Using the Snack Bar Button

- 1 Press the **Snack Bar** button corresponding to the food you are cooking. The display shows "A-1"(item code).
Press the **Snack Bar** button repeatedly to select the item you want.(Refer to the **Snack Bar Chart** below)
- 2 Press the **Number 1** or **2** button to select the serving size you want. Only the **1** button(serving) is available for Nachos. (Refer to the **Snack Bar Chart** below for the serving)
- 3 Press **Start** button to begin cooking.

Snack Bar Chart

Item	Code	Weight	Remarks
Nachos	A-1	1 serving	<ul style="list-style-type: none"> • Place tortilla chips on plate without overlapping. • Sprinkle evenly with cheese. • Contents : - 2 cups tortilla chips - 1/3 cup grated cheese
Chicken Wings	A-2	5-6 oz 7-8 oz	<ul style="list-style-type: none"> • Use pre-cooked, refrigerated chicken wings. • Place chicken wings around plate in spoke fashion and cover with wax paper.
Potato Skins	A-3	1 cooked potato 2 cooked potatoes	<ul style="list-style-type: none"> • Cut cooked potato into 4 even wedges. Scoop or cut out potato flesh, leaving about 1/4" of skin. • Place skins in spoke fashion around plate. • Sprinkle with bacon, onions and cheese. Do not cover.
Cheese Sticks	A-4	5-6 pcs 7-10 pcs	<ul style="list-style-type: none"> • Place cheese sticks on plate in spoke fashion. • Do not cover.

Operation

Reheating Automatically (MW1240/1440, ME1240/1440/1280/1480)

To reheat food, select the type of dish and the number of servings you want to reheat, and the microwave automatically sets the reheating time.

- 1** Press the **Auto Reheat** button repeatedly to select the type of dish you wish to reheat. The initial serving size for each dish is one serving. You can select up to four servings for casseroles and pasta reheat. Only one serving is available for a plate of food. The display shows the dish and quantity you have chosen.
- 2** Use the number buttons to increase the serving size. **For example, for three servings, press the 3 button(Refer to the Auto Reheat Chart below for the servings).** The display shows the number of servings you have selected:
- 3** Press the **Start** button. The display will show Cooking Time.

Auto Reheat Chart

Item	Weight	Remarks
Plate of food	1 serving	<ul style="list-style-type: none"> • Use only pre-cooked, refrigerated foods. • Cover plate with vented plastic wrap or wax paper. • Contents <ul style="list-style-type: none"> - 3-4 oz. meat, poultry or fish (up to 6 oz. with bone) - ½ cup starch (potatoes, pasta, rice, etc.) - ½ cup vegetables (about 3-4 oz.)
Casserole	1 to 4 servings (8 oz./serving)	<ul style="list-style-type: none"> • Use only refrigerated foods. • Cover with lid or vented plastic wrap.
Pasta Reheat	1 to 4 servings (8 oz./serving)	<ul style="list-style-type: none"> • Stir foods well before serving.

Defrosting Automatically

To thaw frozen food, set the weight of the food and the microwave automatically sets the defrosting time, power level and standing time.

- 1** Press the **Auto Defrost** button. The display shows "0.5 lbs." (0.2Kg if you have set your oven for metric measure). ("ENTER" and "Lbs." will flash).
- 2** To set the weight of your food, press the **Auto Defrost** button repeatedly. This increases the weight by 0.5 lb increments, up to 6.0 lbs (The Auto Defrost button will increase the weight by 0.2Kg up to 2.6kg if you are using metric measurement).

You can also use the number buttons to enter the weight of the food directly.

The oven calculates the defrosting time and starts automatically. Twice during defrosting, the oven will beep to let you know to turn the food over.
- 3** Press the **Pause/Cancel** button, open the oven door, and turn the food over.
- 4** Press the **Start** button to resume defrosting.

- **See page 17 for the Auto Defrosting Guide.**

Operation

Setting Cooking Times & Power Levels

Your microwave allows you to set up to two different stages of cooking, each with its own time length and power level. The power level button lets you control the heating intensity from Warm (1) to High (0).

One-stage Cooking

For simple one-stage cooking, you only need to set a cooking time. The power level is automatically set to High. If you want to set the power to any other level, you must set it using the **Power Level** button.

- 1 Use the number buttons to set a cooking time. You can set a time from one second to 99 minutes, 99 seconds. To set a time over one minute, enter the seconds too. **For example, to set 20 minutes, enter 2, 0, 0.**
- 2 If you want to set the power level to something other than High, press the **Power Level** button, then use the number buttons to enter a power level.

Power Levels:

1 = PL:10 (Warm)	6 = PL:60 (Simmer)
2 = PL:20 (Low)	7 = PL:70 (Medium High)
3 = PL:30 (Defrost)	8 = PL:80 (Reheat)
4 = PL:40 (Medium Low)	9 = PL:90 (Sauté)
5 = PL:50 (Medium)	0 = PL:Hi (High)

- 3 Press the **Start** button to begin cooking. If you want to change the power level, press **Pause/Cancel** before you press **Start**, and re-enter all of the instructions.

Some recipes require different stages of cooking at different temperatures. You can set multiple stages of cooking with your microwave.

Multi-stage Cooking

- 1 Follow steps 1 and 2 in the "One-Stage Cooking" section on the previous page.
*When entering more than one cooking stage, the **Power Level** button must be pressed before the second cooking stage can be entered.*
*To set the power level at High for a stage of cooking, press the **Power Level** button twice.*
- 2 Use the number buttons to set a second cooking time.
- 3 Press the **Power Level** button, then use the number buttons to set the power level of the second stage of cooking.
- 4 Press **Start** to begin cooking.

You can check the Power Level while cooking is in progress by pressing the **Power Level** button.

Demonstration Mode

You can use the Demonstration Mode to see how your microwave oven operates without the oven heating.

- 1 Hold the **0** button and then press the **1** button.
To turn demo mode off, repeat step 1 above.

Using the More/Less Buttons

The **More/Less** buttons allow you to adjust pre-set cooking times. They only work in the **Instant, Handy Helper, Kids Meals, Snack Bar, Auto Reheat** or **Time Cook** modes. Use the **More/Less** button only after you have already begun cooking with one of these procedures.

* **Auto Reheat : MW1240/1440,ME1240/1440/1280/1480**

- 1 To **ADD** more time to an automatic cooking procedure: Press the **More(9)** button.
- 2 To **REDUCE** the time of an automatic cooking procedure: Press the **Less(1)** button.

*If you wish to increase/decrease in **Time Cook** mode by 10sec, press the **More(9)** or **Less(1)** button.*

Switching the Beeper On/Off

You can switch the beeper off whenever you want.

- 1 Press the **Sound** button. The display shows "ON". ("START" will flash)
- 2 Press the **Sound** button to turn the volume off. The display shows: "OFF". ("START" will flash)
- 3 Press **Start**.
The display returns to the time of day.

Using the Kitchen Timer

- 1 Press the **Kitchen Timer** button.
- 2 Use the **Number** buttons to set the length of time you want the timer to run.
- 3 Press **Start** to begin Kitchen Timer.
- 4 The display counts down and beeps when the time has elapsed.

Note: The microwave does not turn on when the Kitchen timer is used.

Setting the Child Protection Lock

You can lock your microwave oven so it can't be used by unsupervised children.

- 1 Hold the "0" button and then press the **2** button. The display shows "Loc".

At this point, the microwave oven cannot be used until it is unlocked. To unlock it, repeat step 1 above.

Cooking Instructions

Cooking Utensils

Recommended Use

- **Glass and glass-ceramic bowls and dishes** — Use for heating or cooking.
- **Microwavable browning dish** — Use to brown the exterior of small items such as steaks, chops, or pancakes. Follow the directions provided with your browning dish.
- **Microwavable plastic wrap** — Use to retain steam. Leave a small opening for some steam to escape and avoid placing it directly on the food.
- **Wax paper** — Use as a cover to prevent spattering.
- **Paper towels and napkins** — Use for short-term heating and covering; they absorb excess moisture and prevent spattering. Do not use recycled paper towels, which may contain metal and can catch fire.
- **Paper plates and cups** — Use for short-term heating at low temperatures. Do not use recycled paper, which may contain metal and can catch fire.
- **Thermometers** — Use only those labeled "Microwave Safe" and follow all directions. Check the food in several places. Conventional thermometers may be used once the food has been removed from the oven.

Limited Use

- **Aluminum foil** — Use narrow strips of foil to prevent overcooking of exposed areas. Using too much foil can damage your oven, so be careful.
- **Ceramic, porcelain, and stoneware** — Use these if they are labeled "Microwave Safe". If they are not labeled, test them to make sure they can be used safely. Never use dishes with metallic trim.
- **Plastic** — Use only if labeled "Microwave Safe". Other plastics can melt.
- **Straw, wicker, and wood** — Use only for short-term heating, as they can be flammable.

Not Recommended

- **Glass jars and bottles** — Regular glass is too thin to be used in a microwave, and can shatter.
- **Paper bags** — These are a fire hazard, except for popcorn bags that are designed for microwave use.
- **Styrofoam plates and cups** — These can melt and leave an unhealthy residue on food.
- **Plastic storage and food containers** — Containers such as margarine tubs can melt in the microwave.
- **Metal utensils** — These can damage your oven. Remove all metal before cooking.

Testing Utensils

If you are not sure whether a dish is microwave-safe or not, you can perform this test:

- 1 Fill one measuring cup with water and put it inside your oven, next to the dish you want to test.

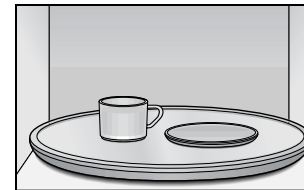

- 2 Press the **One Minute +** button once to heat them for one minute at High power.

The water should be warm and the dish you are testing should be cool. If the dish is warm, then it is absorbing microwave energy and is not acceptable for use in the microwave.

Cooking Instructions

Cooking Techniques

Stirring

Stir foods such as casseroles and vegetables while cooking to distribute heat evenly. Food at the outside of the dish absorbs more energy and heats more quickly, so stir from the outside to the center. The oven will turn off when you open the door to stir your food.

Arrangement

Arrange unevenly shaped foods, such as chicken pieces or chops, with the thicker, meatier parts toward the outside of the turntable where they receive more microwave energy. To prevent overcooking, place thin or delicate parts toward the center of the turntable.

Shielding

Shield food with narrow strips of aluminum foil to prevent overcooking. Areas that need shielding include poultry wing-tips, the ends of poultry legs, and corners of square baking dishes. Use only small amounts of aluminum foil. Larger amounts can damage your oven.

Turning

Turn foods over midway through cooking to expose all parts to microwave energy. This is especially important with large items such as roasts.

Standing

Foods cooked in the microwave build up internal heat and continue to cook for a few minutes after the oven stops. Let foods stand to complete cooking, especially foods such as roasts and whole vegetables. Roasts need this time to complete cooking in the center without overcooking the outer areas. All liquids, such as soup or hot chocolate, should be shaken or stirred when cooking is complete. Let liquids stand a moment before serving. When heating baby food, stir well and test the temperature before serving.

Adding Moisture

Microwave energy is attracted to water molecules. Food that is uneven in moisture content should be covered or allowed to stand so that the heat disperses evenly. Add a small amount of water to dry food to help it cook.

General Tips

- Dense foods, such as potatoes, take longer to heat than lighter foods. Foods with a delicate texture should be heated at a low power level to avoid becoming tough.
- Altitude and the type of cookware you are using can affect cooking time. When using a new recipe, use the minimum cooking time and check the food occasionally to prevent overcooking.
- Foods with a non-porous skin such as potatoes or hot dogs, should be pierced to prevent bursting.
- Frying with heating oil or fat is not recommended. Fat and oil can suddenly boil over and cause severe burns.
- Some ingredients heat faster than others. For example, the jelly inside a jelly doughnut will be hotter than the dough. Keep this in mind to avoid burns.
- Home canning in the microwave oven is not recommended because all harmful bacteria may not be destroyed by the microwave heating process.
- Although microwaves do not heat the cookware, the heat from the food is often transferred to the cookware. Always use pot holders when removing food from the microwave and instruct children to do the same.
- Making candy in the microwave is not recommended as candy can heat to very high temperatures. Keep this in mind to avoid injury.

Cooking Instructions

Cooking Guide

Guide for Cooking Meat in Your Microwave

- Place meat on a microwave-safe roasting rack in a microwave-safe dish.
- Start meat fat-side down. Use narrow strips of aluminum foil to shield any bone tips or thin meat areas.
- Check the temperature in several places before letting the meat stand the recommended time.
- The following temperatures are removal temperatures. The temperature of the food will rise during the standing time.

Food	Cook Time/Power Level	Directions
Roast Beef Boneless Up to 4 lbs.	Cooking Time: 7-11 min. / lb. for 115° F - Rare 8-12 min. / lb. for 120° F - Medium 9-14 min. / lb. for 145° F - Well Done Power Level: High(0) for first 5 min., then Medium(5).	Place roast fat-side down on roasting rack. Cover with wax paper. Turn over when cooking time is half up. Let stand 10 min.
Pork Boneless or bone-in Up to 4 lbs.	Cooking Time: 11-15 min. / lb. for 160° F Well Done Power Level: High(0) for first 5 min., then Medium(5).	Place roast fat-side down on roasting rack. Cover with vented plastic wrap. Turn over when cooking time is half up. Let stand 10 min.

Guide for Cooking Poultry in Your Microwave

- Place poultry on a microwave-safe roasting rack in a microwave-safe dish.
- Cover poultry with wax paper to prevent spattering.
- Use aluminum foil to shield bone tips, thin meat areas, or areas that start to overcook.
- Check the temperature in several places before letting the poultry stand the recommended time.

Food	Cook Time/Power Level	Directions
Whole Chicken Up to 4 lbs.	Cooking Time: 6-9 min. / lb. 180°F Power Level: Medium High(7).	Place chicken breast-side down on roasting rack. Cover with wax paper. Turn over when the cooking time is half up. Cook until juices run clear and meat near the bone is no longer pink. Let stand 5-10 min.
Chicken Pieces Up to 2 lbs.	Cooking Time: 6-9 min. / lb. 180°F dark meat 170°F light meat Power Level: Medium High(7).	Place chicken bone-side down on dish, with the thickest portions towards the outside of the dish. Cover with wax paper. Turn over when the cooking time is half up. Cook until juices run clear and meat near the bone is no longer pink. Let stand 5-10 min.

Guide for Cooking Seafood in Your Microwave

- Cook fish until it flakes easily with a fork.
- Place fish on a microwave-safe roasting rack in a microwave-safe dish.
- Use a tight cover to steam fish. A lighter cover of wax paper or paper towel provides less steaming.
- Do not overcook fish; check it at minimum cooking time.

Food	Cook Time/Power Level	Directions
Steaks Up to 1.5 lbs.	Cooking Time: 6-10 min. / lb. Power Level: Medium-High(7).	Arrange steaks on roasting rack with meaty portions towards the outside of rack. Cover with wax paper. Turn over and rearrange when cooking time is half up. Cook until fish flakes easily with a fork. Let stand 3-5 min.
Fillets Up to 1.5 lbs.	Cooking Time: 3-7 min. / lb Power Level: Medium-High(7).	Arrange fillets in a baking dish, turning any thin pieces under. Cover with wax paper. If over ½ inch thick, turn over and rearrange when cooking time is half up. Cook until fish flakes easily with a fork. Let stand 2-3 min.
Shrimp Up to 1.5 lbs.	Cooking Time: 3-5 ½ min. / lb. Power Level: Medium-High(7).	Arrange shrimp in a baking dish without overlapping or layering. Cover with wax paper. Cook until firm and opaque, stirring 2 or 3 times. Let stand 5 min.

Cooking Instructions

Guide for Cooking Eggs in Your Microwave

- Never cook eggs in the shell, and never warm hard-cooked eggs in the shell; they can explode.
- Always pierce whole eggs to keep them from bursting.
- Cook eggs just until set; they become tough if overcooked.

Guide for Cooking Vegetables in Your Microwave

- Vegetables should be washed just before cooking. Often, no extra water is needed. If dense vegetables such as potatoes, carrots and green beans are being cooked, add about ¼ cup water.
- Small vegetables (sliced carrots, peas, lima beans, etc.) will cook faster than larger ones.
- Whole vegetables, such as potatoes, acorn squash or corn on the cob, should be arranged in a circle on the turntable before cooking. They will cook more evenly if turned over after half the cooking time.
- Always place vegetables like asparagus and broccoli with the stem ends pointing towards the edge of the dish and the tips toward the center.
- When cooking cut vegetables, always cover the dish with a lid or vented microwavable plastic wrap.
- Whole, unpeeled vegetables such as potatoes, squash, eggplant, etc., should have their skin pricked in several spots before cooking to prevent them from bursting.
- For more even cooking, stir or rearrange whole vegetables halfway through the cooking time.
- Generally, the denser the food, the longer the standing time. (Standing time refers to the time necessary for dense, large foods and vegetables to finish cooking after they come out of the oven.) A baked potato can stand on the counter for five minutes before cooking is completed, while a dish of peas can be served immediately.

Auto Defrosting Guide

- Follow the instructions below when defrosting different types of food.

Food	Standard Amount	Procedure
Roast Beef, Pork	2.5-6.0 lbs.	Start with the food placed fat side down. After each stage, turn the food over and shield any warm portions with narrow strips of aluminum foil.
Steaks, Chops, Fish	0.5-3.0 lbs.	After each stage, rearrange the food. If there are any warm or thawed portions of food, shield them with narrow flat pieces of aluminum foil. Remove any pieces of food that are nearly defrosted. Let stand, covered, for 5-10 minutes.
Ground Meat	0.5-3.0 lbs.	After each stage, remove any pieces of food that are nearly defrosted. Let stand, covered with foil, for 5-10 minutes.
Whole Chicken	2.5-6.0 lbs.	Remove giblets before freezing poultry. Start defrosting with the breast side down. After the first stage, turn the chicken over and shield any warm portions with narrow strips of aluminum foil. After the second stage, again shield any warm portions with narrow strips of aluminum foil. Let stand, covered, for 30-60 minutes in the refrigerator.
Chicken Pieces	0.5-3.0 lbs.	After each stage, rearrange or remove any pieces of food that are nearly defrosted. Let stand for 10-20 minutes.

Notes

Check foods when the oven signals. After the final stage, small sections may still be icy; let them stand to continue thawing. Do not defrost until all ice crystals have thawed. Shielding roasts and steaks with small pieces of foil prevents the edges from cooking before the center of the food has defrosted. Use narrow, flat, smooth strips of aluminum foil to cover the edges and thinner sections of the food.

Cooking Instructions

Recipes

Beef and Barley Stew

1½ lbs. beef stew cubes, cut into ½-inch pieces
½ cup chopped onion
2 Tbs. all-purpose flour
1 Tbs Worcestershire sauce
1 can (13.75-14.5 oz.) beef broth
2 medium carrots, cut into ½-inch slices (about 1 cup)
½ cup barley
1 bay leaf
¼ tsp. pepper
1 pkg. (9-10 oz.) frozen peas, thawed

1. In a 2-quart casserole, combine beef, onion, flour, and Worcestershire; mix well. Cover with lid. Cook at High(0) for 6 to 8 minutes until beef is no longer pink, stirring once.
2. Stir in beef broth, carrots, barley, bay leaf, and pepper. Cover with lid. Cook at Medium for 1 to 1½ hours until carrots and beef are tender, stirring 2 to 3 times.
3. Stir in peas. Cover with lid. Cook at Medium for 10 minutes. Let stand for 10 minutes. Remove bay leaf before serving.

Makes 6 servings.

Broccoli and Cheese Casserole

¼ cup butter or margarine
¼ cup chopped onion
1½ Tbs. flour
½ tsp. salt
¼ tsp. dry mustard
1/8 tsp. pepper
1½ cups milk
¼ cup chopped red pepper
8 oz. (2 cups) cheddar cheese, shredded
1 pkg. (9-10 oz.) frozen chopped broccoli, thawed
4 cups cooked spiral shaped pasta (8 oz. dry)

1. In a 2-quart casserole, cook butter and onion at High(0) for 1 to 2 minutes until onion is soft, stirring once.
2. Add flour, salt, mustard, and pepper; mix well. Cook at High(0) for 30 to 60 seconds until mixture boils. Stir in milk until smooth.
3. Stir in red pepper. Cook at High(0) for 2 to 3 minutes until mixture boils and thickens slightly, stirring twice. Stir in cheese until melted.
4. Add broccoli and pasta, mix well. Cover with lid. Cook at High(0) for 4 to 6 minutes until heated through, stirring once. Stir before serving.

Makes 6 servings.

Warm Potato Salad

2 lbs. small red potatoes, cut into ½-inch pieces
4 slices bacon (uncooked), cut into ½-inch pieces
¼ cup chopped onion
2 tsp. sugar
1 tsp. salt
1 tsp. flour
½ tsp. celery seed
1/8 tsp. pepper
2½ Tbs. apple cider vinegar

1. In a 2-quart casserole, combine potatoes and ¼ cup water. Cover with lid. Cook at High(0) until potatoes are tender (7-10 min.); stir twice. Drain and set aside to cool slightly.
2. In a medium bowl, cook bacon at High(0) until crisp (2½-3½ min.); stir once. Place bacon on a paper towel. Reserve 1 Tbs. drippings.
3. Combine drippings and onion. Cover with plastic wrap; turn back a corner to vent steam. Cook at High(0) until tender (1½-2½ min.); stir once.
4. Stir in sugar, salt, flour, celery seed, and pepper. Cook at High(0) until mixture boils (30-40 sec.). Stir in vinegar and ½ cup water. Cook at High(0) until liquid boils and thickens slightly (1-2 min.); stir once. Add bacon to dressing. Pour dressing over potatoes. Stir well.

Makes 6 servings.

Black Bean Soup

1 cup chopped onion
1 clove garlic, minced
2 cans (15 oz. each) black beans, drained
1 can (14-16 oz.) stewed tomatoes, chopped
1 can (13.75-14.5 oz.) chicken broth
1 can (7-8.5 oz.) corn
1 can (4 oz.) chopped green chilies
1-2 tsp. ground cumin, or to taste

1. Place onion and garlic in a 3-quart casserole. Cover with lid. Cook at High(0) for 2 to 4 minutes until tender.
2. Add one can of beans, mash beans with a fork. Add remaining ingredients; mix well.
3. Cook uncovered, at High(0) for 10 minutes; stir. Reduce power to Medium and cook for 5 minutes. Stir before serving.

Makes about 2 quarts.

Appendix

Troubleshooting Guide

Before you call a repair person for your oven, check this list of possible problems and solutions.

Neither the oven's display nor the oven operate.

- Properly insert the plug into a grounded outlet.
- If the outlet is controlled by a wall switch, make sure the wall switch is turned on.
- Remove the plug from the outlet, wait ten seconds, then plug it in again.
- Reset the circuit breaker or replace any blown fuse.
- Plug another appliance into the outlet; if the other appliance doesn't work, have a qualified electrician repair the outlet.
- Plug the oven into a different outlet.

The oven's display works, but the power won't come on.

- Make sure the door is closed securely.
- Check to see if packing material or other material is stuck to the door seal.
- Check for door damage.
- Press Cancel twice and re-enter all cooking instructions.

The power goes off before the set time has elapsed.

- If there has not been a power outage, remove the plug from the outlet, wait ten seconds, then plug it in again. If there was a power outage, the time indicator will display " **EE:EE** ". Reset the clock and any cooking instructions.
- Reset the circuit breaker or replace any blown fuse.

The food is cooking too slowly.

- Make sure the oven is on its own 20 amp circuit line. Operating another appliance on the same circuit can cause a voltage drop. If necessary, move the oven to its own circuit.

You see sparks or arcing.

- Remove any metallic utensils, cookware, or metal ties. If using foil, use only narrow strips and allow at least one inch between the foil and interior oven walls.

The turntable makes noises or sticks.

- Clean the turntable, roller ring and oven floor.
- Make sure the turntable and roller ring are positioned correctly.

Using your microwave causes TV or radio interference.

- This is similar to the interference caused by other small appliances, such as hair dryers. Move your microwave further away from other appliances, like your TV or radio.

Care and Cleaning

- Follow these instructions to clean and care for your oven.
- Keep the inside of the oven clean. Food particles and spilled liquids can stick to the oven walls, causing the oven to work less efficiently.
- Wipe up spills immediately. Use a damp cloth and mild soap. Do not use harsh detergents or abrasives.
- To help loosen baked on food particles or liquids, heat two cups of water (add the juice of one lemon if you desire to keep the oven fresh) in a four-cup measuring glass at **High** power for five minutes or until boiling. Let stand in the oven for one or two minutes.
- Remove the glass tray from the oven when cleaning the oven or tray. To prevent the tray from breaking, handle it carefully and do not put it in water immediately after cooking. Wash the tray carefully in warm sudsy water or in the dishwasher.
- Clean the outside surface of the oven with soap and a damp cloth. Dry with a soft cloth. To prevent damage to the operating parts of the oven, don't let water seep into the openings.
- Wash the door window with very mild soap and water. Be sure to use a soft cloth to avoid scratching.
- If steam accumulates inside or outside the oven door, wipe with a soft cloth. Steam can accumulate when operating the oven in high humidity and in no way indicates microwave leakage.
- Never operate the oven without food in it; this can damage the magnetron tube or glass tray. You may wish to leave a cup of water in the oven when it is not in use to prevent damage if the oven is accidentally turned on.

**If you have a problem you cannot solve,
please call our service line:**

**1-800-SAMSUNG
(1-800-726-7864)**

Appendix

Specifications

Model Number	MW1040WC/BC
Oven Cavity	1.0cuft
Controls	10 power levels, including defrost
Timer	99 minutes, 99 seconds
Power Source	120 VAC, 60 Hz
Power Output/Consumption	1100 / 1550 Watts
Outside Dimensions	20 ^{11/32"} (W) X 11 ^{13/16"} (H) X 14 ^{29/32"} (D)
Oven Cavity Dimensions	13 ^{7/32"} (W) X 9 ^{3/32"} (H) X 13 ^{23/32"} (D)
Net/Gross Weight	33.8/37.3 lbs

Model Number	MW1240WC/BC
Oven Cavity	1.2cuft
Controls	10 power levels, including defrost
Timer	99 minutes, 99 seconds
Power Source	120 VAC, 60 Hz
Power Output/Consumption	1200 / 1650 Watts
Outside Dimensions	20 ^{19/32"} (W) X 11 ^{25/32"} (H) X 16 ^{13/32"} (D)
Oven Cavity Dimensions	14 ^{31/64"} (W) X 9 ^{1/64"} (H) X 15 ^{19/32"} (D)
Net/Gross Weight	35/39.6 lbs

Model Number	MW1440WC/BC
Oven Cavity	1.4cuft
Controls	10 power levels, including defrost
Timer	99 minutes, 99 seconds
Power Source	120 VAC, 60 Hz
Power Output/Consumption	1200 / 1600 Watts
Outside Dimensions	21 ^{7/8"} (W) X 12 ^{5/16"} (H) X 17 ^{13/16"} (D)
Oven Cavity Dimensions	14 ^{3/4"} (W) X 9 ^{13/16"} (H) X 16 ^{1/16"} (D)
Net/Gross Weight	39.6/42.9 lbs

Model Number	ME1240SC
Oven Cavity	1.2cuft
Controls	10 power levels, including defrost
Timer	99 minutes, 99 seconds
Power Source	120 VAC, 60 Hz
Power Output/Consumption	1100 / 1650 Watts
Outside Dimensions	20 ^{19/32"} (W) X 11 ^{25/32"} (H) X 16 ^{13/32"} (D)
Oven Cavity Dimensions	14 ^{31/64"} (W) X 9 ^{1/64"} (H) X 15 ^{19/32"} (D)
Net/Gross Weight	36/40 lbs

Model Number	ME1440SC
Oven Cavity	1.4cuft
Controls	10 power levels, including defrost
Timer	99 minutes, 99 seconds
Power Source	120 VAC, 60 Hz
Power Output/Consumption	1100 / 1600 Watts
Outside Dimensions	21 ^{7/8"} (W) X 12 ^{5/16"} (H) X 17 ^{13/16"} (D)
Oven Cavity Dimensions	14 ^{3/4"} (W) X 9 ^{13/16"} (H) X 16 ^{1/16"} (D)
Net/Gross Weight	40.0/44.0 lbs

Model Number	ME1280STC
Oven Cavity	1.2cu.ft
Controls	10 power levels, including defrost
Timer	99 minutes, 99 seconds
Power Source	120 VAC, 60 Hz
Power Output/Consumption	1100 / 1650 Watts
Outside Dimensions	20 ^{19/32"} (W) X 11 ^{25/32"} (H) X 16 ^{13/32"} (D)
Oven Cavity Dimensions	14 ^{31/64"} (W) X 9 ^{1/64"} (H) X 15 ^{19/32"} (D)
Net/Gross Weight	35.7/40.4 lbs

Appendix

Specifications

Model Number	ME1480STC
Oven Cavity	1.4cuft
Controls	10 power levels, including defrost
Timer	99 minutes, 99 seconds
Power Source	120 VAC, 60 Hz
Power Output/Consumption	1100/1600 Watts
Outside Dimensions	21 ^{7/8} "(W) X 12 ^{5/16} "(H) X 17 ^{13/16} "(D)
Oven Cavity Dimensions	14 ^{3/4} "(W) X 9 ^{13/16} "(H) X 16 ^{1/16} "(D)
Net/Gross Weight	41.2/44.5 lbs

Warranty

Warranty Information

SAMSUNG MICROWAVE OVEN

LIMITED WARRANTY TO ORIGINAL PURCHASER

This SAMSUNG brand product, as supplied and distributed by SAMSUNG ELECTRONICS AMERICA, INC. (SAMSUNG) and delivered new, in the original carton to the original consumer purchaser, is warranted by SAMSUNG against manufacturing defects in materials and workmanship for a limited warranty period of:

One (1) Year Parts and Labor, Eight (8) Years Parts Warranty for Magnetron

This limited warranty begins on the original date of purchase, and is valid only on products purchased and used in the United States. To receive warranty service, the purchaser must contact SAMSUNG for problem determination and service procedures. Warranty service can only be performed by a SAMSUNG authorized service center. The original dated bill of sale must be presented upon request as proof of purchase to SAMSUNG or SAMSUNG's authorized service center. Transportation of the product to and from the service center is the responsibility of the purchaser.

SAMSUNG will repair or replace this product, at our option and at no charge as stipulated herein, with new or reconditioned parts or products if found to be defective during the limited warranty period specified above. All replaced parts and products become the property of SAMSUNG and must be returned to SAMSUNG. Replacement parts and products assume the remaining original warranty, or ninety (90) days, whichever is longer.

This limited warranty covers manufacturing defects in materials and workmanship encountered in normal, non-commercial use of this product and shall not apply to the following, including, but not limited to: damage which occurs in shipment; delivery and installation; applications and uses for which this product was not intended; altered product or serial numbers; cosmetic damage or exterior finish; accidents, abuse, neglect, fire, water, lightning or other acts of nature; use of products, equipment, systems, utilities, services, parts, supplies, accessories, applications, installations, repairs, external wiring or connectors not supplied or authorized by SAMSUNG which damage this product or result in service problems; incorrect electrical line voltage, fluctuations and surges; customer adjustments and failure to follow operating instructions, cleaning, maintenance and environmental instructions that are covered and prescribed in the instruction book; product removal and

Warranty

reinstallation; problems caused by pest infestations, and overheating or overcooking by user; glass tray or turntable; reduced magnetron power output related to normal aging. SAMSUNG does not warrant uninterrupted or error-free operation of the product.

THERE ARE NO EXPRESS WARRANTIES OTHER THAN THOSE LISTED AND DESCRIBED ABOVE, AND NO WARRANTIES WHETHER EXPRESS OR IMPLIED, INCLUDING, BUT NOT LIMITED TO, ANY IMPLIED WARRANTIES OF MERCHANTABILITY OR FITNESS FOR A PARTICULAR PURPOSE, SHALL APPLY AFTER THE EXPRESS WARRANTY PERIODS STATED ABOVE, AND NO OTHER EXPRESS WARRANTY OR GUARANTY GIVEN BY ANY PERSON, FIRM OR CORPORATION WITH RESPECT TO THIS PRODUCT SHALL BE BINDING ON SAMSUNG. SAMSUNG SHALL NOT BE LIABLE FOR LOSS OF REVENUE OR PROFITS, FAILURE TO REALIZE SAVINGS OR OTHER BENEFITS, OR ANY OTHER SPECIAL, INCIDENTAL OR CONSEQUENTIAL DAMAGES CAUSED BY THE USE, MISUSE OR INABILITY TO USE THIS PRODUCT, REGARDLESS OF THE LEGAL THEORY ON WHICH THE CLAIM IS BASED, AND EVEN IF SAMSUNG HAS BEEN ADVISED OF THE POSSIBILITY OF SUCH DAMAGES. NOR SHALL RECOVERY OF ANY KIND AGAINST SAMSUNG BE GREATER IN AMOUNT THAN THE PURCHASE PRICE OF THE PRODUCT SOLD BY SAMSUNG AND CAUSING THE ALLEGED DAMAGE. WITHOUT LIMITING THE FOREGOING, PURCHASER ASSUMES ALL RISK AND LIABILITY FOR LOSS, DAMAGE OR INJURY TO PURCHASER AND PURCHASER'S PROPERTY AND TO OTHERS AND THEIR PROPERTY ARISING OUT OF THE USE, MISUSE OR INABILITY TO USE THIS PRODUCT SOLD BY SAMSUNG NOT CAUSED DIRECTLY BY THE NEGLIGENCE OF SAMSUNG. THIS LIMITED WARRANTY SHALL NOT EXTEND TO ANYONE OTHER THAN THE ORIGINAL PURCHASER OF THIS PRODUCT, IS NONTRANSFERABLE AND STATES YOUR EXCLUSIVE REMEDY.

Some states do not allow limitations on how long an implied warranty lasts, or the exclusion or limitation of incidental or consequential damages, so the above limitations or exclusions may not apply to you. This warranty gives you specific legal rights, and you may also have other rights which vary from state to state.

To obtain warranty service, please contact: **SAMSUNG ELECTRONICS AMERICA, INC. - WWW.SAMSUNGUSA.COM**

SAMSUNG CUSTOMER SERVICE
400 VALLEY ROAD, SUITE 201,
MT. ARLINGTON, NJ 07856
Tel: 973-601-6000, Fax: 973-601-6001
1-800-SAMSUNG (1-800-726-7864)
WWW.SAMSUNGSUPPORT.COM

SAMSUNG ELECTRONICS

NORTH AMERICAN LIMITED WARRANTY ADDENDUM

Subject to the requirements, conditions, exclusions and limitations of the Original Limited Warranty supplied with Samsung Electronics (SAMSUNG) products, and the requirements, conditions, exclusions and limitations contained herein, SAMSUNG will additionally provide Warranty Repair Service in the United States on SAMSUNG products purchased in Canada, and in Canada on SAMSUNG products purchased in the United States, for the warranty period originally specified, and to the Original Purchaser only.

The above described warranty repairs must be performed by a SAMSUNG Authorized Service Center. Along with this Statement, the Original Limited Warranty Statement and a dated Bill of Sale as Proof of Purchase must be presented to the Service Center. Transportation to and from the Service Center is the responsibility of the purchaser.

Conditions covered are limited only to manufacturing defects in material or workmanship, and only those encountered in normal use of the product.

Excluded, but not limited to, are any original specified provisions for, in-home or on-site services, minimum or maximum repair times, exchanges or replacements, accessories, options, upgrades, or consumables.

For the locations of a SAMSUNG Authorized Service Center in the United States and Canada, please contact SAMSUNG at:

1-800-SAMSUNG (1-800-726-7864)

Or on-line at:

WWW.SAMSUNGUSA.COM and WWW.SAMSUNGCANADA.COM

Guía de Consulta Rápida en Español(Spanish)

Usando el Botón PAUSE/CANCEL

- Para pausar mientras está cocinando, oprima una vez al botón PAUSE/CANCEL.
- Para detener el horno y borrar las instrucciones para cocinar, oprima dos veces al botón PAUSE/CANCEL.
- Para corregir un error de programación, oprima una vez al botón PAUSE/CANCEL y vuelva a programar las instrucciones.
- Para cancelar un ajuste del cronómetro, oprima una vez al botón PAUSE/CANCEL.

Poniendo el Reloj

- Oprima una vez al botón CLOCK.
- Utilice los botones numéricos 0–9 para seleccionar la hora correcta.
- Oprima una vez más al botón CLOCK para fijar la hora.

Ajustando el Tiempo de Cocinar y Niveles de Potencia – Cocinando en una Etapa

- Utilice los botones numéricos 0–9 para ajustar el tiempo de cocinar.
- Oprima el botón POWER LEVEL, y los botones numéricos 0–9 para seleccionar la potencia de cocinar (si es diferente a 0).
- Oprima el botón START para comenzar a cocinar.

Ajustando el Tiempo de Cocinar y Niveles de Potencia – Cocinando en Etapas Múltiples

- Utilice los botones numéricos 0–9 para ajustar el tiempo de cocinar.
- Oprima el botón POWER LEVEL, y los botones numéricos 0–9 para seleccionar la potencia de cocinar (si es diferente a 0).
- Utilice los botones numéricos 0–9 para ajustar el segundo tiempo de cocinar.
- Oprima el botón POWER LEVEL, y los botones numéricos 0–9 para seleccionar la potencia de cocinar (si es diferente a 0).
- Utilice los botones numéricos 0–9 para ajustar el tercer tiempo de cocinar.
- Oprima el botón POWER LEVEL, y los botones numéricos 0–9 para seleccionar la potencia de cocinar (si es diferente a 0).
- Oprima el botón START para comenzar a cocinar.

Descongelado Automático

- Oprima repetidamente al botón AUTO DEFROST para ajustar el peso correcto de la comida que va descongelar.

Cocinando Con un Bóton

- Oprima el botón ONE MINUTE + una vez para cada minuto que desea cocinar.

Ajustando el Tiempo de Cocinado

- Si desea ajustar el tiempo de cocinado mientras el horno está en operación, oprima el botón MORE/LESS repetidamente hasta llegar al tiempo deseado.

Usando el Cronómetro

- Oprima los botones numéricos 0–9 para ajustar el tiempo, luego oprima el botón KITCHEN TIMER.

Handy Helper, Kids Meals, Snack Bar

- Presione HANDY HELPER(KIDS MEALS, SNACK BAR) repetidamente para seleccionar tipo de platillo.
- Para incrementar tamaño de porción, presione los botones numéricos.
- Presione START para comenzar.

Recalentado Automático

(MW1240/1440,ME1240/1440/1280/1480)

- Presione AUTO REHEAT repetidamente para seleccionar tipo de platillo.
- Para incrementar tamaño de porción, presione los botones numéricos
- Presione START para comenzar.

Quick Reference(English)

Feature	Operation
Set Clock	<ol style="list-style-type: none"> 1. Press CLOCK. 2. Use number buttons to enter the current time. 3. Press CLOCK again.
One Stage Cooking	<ol style="list-style-type: none"> 1. Use number buttons to set cooking time. 2. Set power level or leave at High. 3. Press START.
One Minute+ Cooking	<ol style="list-style-type: none"> 1. Press the ONE MINUTE + button once for each minute of cooking. 2. The time will display and the oven will start.
Instant Cook Buttons	<ol style="list-style-type: none"> 1. Press button that corresponds to the food you are cooking (for example, BEVERAGE). 2. Press the button repeatedly to select serving size.
Auto Defrost	<ol style="list-style-type: none"> 1. Press AUTO DEFROST. 2. Enter weight of food by pressing AUTO DEFROST button repeatedly or using the number buttons. 3. When the oven beeps, press PAUSE/CANCEL button and turn food over. Press START to resume defrosting cycle.
Set Cooking Time and Power Levels	<ol style="list-style-type: none"> 1. Use number buttons to set cooking time. 2. To set power level at other than HIGH, press POWER LEVEL and use the number buttons to enter the power level. 3. Press START to begin cooking.
Handy Helper, Kids Meals, Snack Bar	<ol style="list-style-type: none"> 1. Press HANDY HELPER(KIDS MEALS, SNACK BAR) repeatedly to select type of dish to reheat. 2. To increase serving size, press the corresponding number button. 3. Press START to begin cooking.
Auto Reheat <small>(MW1240/1440, ME1240/1440/1280/1480)</small>	<ol style="list-style-type: none"> 1. Press AUTO REHEAT repeatedly to select type of dish to reheat. 2. To increase serving size, press the corresponding number button. 3. Press START to begin reheating cycle.



SAMSUNG ELECTRONICS AMERICA, INC.
HEADQUARTERS
105 CHALLENGER ROAD
RIDGEFIELD PARK, NEW JERSEY 07660-0511

Samsung Electronics Co., Ltd.
 March 2003
 Printed in Korea

Free Manuals Download Website

<http://myh66.com>

<http://usermanuals.us>

<http://www.somanuals.com>

<http://www.4manuals.cc>

<http://www.manual-lib.com>

<http://www.404manual.com>

<http://www.luxmanual.com>

<http://aubethermostatmanual.com>

Golf course search by state

<http://golfingnear.com>

Email search by domain

<http://emailbydomain.com>

Auto manuals search

<http://auto.somanuals.com>

TV manuals search

<http://tv.somanuals.com>