

Microwave Oven

user manual

imagine the possibilities

Thank you for purchasing this Samsung product. Please register your product at www.samsung.com/global/register



features of your new microwave oven

- **Professional Design**

The new Stainless Steel Samsung Over The Range (OTR) oven has a clean, professional look that matches your other kitchen appliances perfectly, providing a harmonious and complete kitchen solution.

- **Turbo vent**

With 400 CFM(Cubic Feet per Minute, Ft³/min) of ventilation power, your new Over The Range (OTR) oven offers optimal cooking conditions by absorbing smoke and odor from the cook-top. It is also as silent as other OTRs with much lower ventilation power. Experience maximum power with no additional noise!

- **Large Interior capacity**

With its 1.8 cu.ft capacity, your OTR oven delivers plenty of space for all your cooking needs. A big capacity combined with 1,100 watts of output guarantees superior cooking results.

- **Sensor Cooking**

Don't know how to cook? Samsung's new OTR sensor technology offers preset functions resulting in perfectly cooked dishes every time. Simply select a cooking menu, and the cooking results will astound you.

- **VFD display**

With an informative VFD (Vacuum Fluorescent Display), your OTR lets you easily use all available functions.

safety information

PRECAUTIONS TO AVOID POSSIBLE EXPOSURE TO EXCESSIVE MICROWAVE ENERGY

- A. Do not attempt to operate this oven with the door open since open-door operation can result in harmful exposure to microwave energy. It is important not to defeat or tamper with the safety interlocks.
- B. Do not place any object between the oven front face and the door or allow soil or cleaner residue to accumulate on sealing surface.
- C. Do not operate the oven if it is damaged. It is particularly important that the oven door close properly and that there is no damage to the:
 1. Door (bent),
 2. hinges and latches, (broken or loosened),
 3. door seals and sealing surface.
- D. The oven should not be adjusted or repaired by anyone except properly qualified service personnel.

safety information











Congratulations on your new Samsung microwave oven. This manual contains important information on the installation, use and care of your appliance. Please take time to read this manual to take full advantage of your microwave oven's many benefits and features.

WHAT YOU NEED TO KNOW ABOUT SAFETY INSTRUCTIONS

Warnings and Important Safety Instructions in this manual do not cover all possible conditions and situations that may occur. It is your responsibility to use common sense, caution, and care when installing, maintaining, and operating your microwave oven.

IMPORTANT SAFETY SYMBOLS AND PRECAUTIONS

What the icons and signs in this user manual mean:

 WARNING	Hazards or unsafe practices that may result in severe personal injury or death.
 CAUTION	Hazards or unsafe practices that may result in minor personal injury or property damage.
 CAUTION	To reduce the risk of fire, explosion, electric shock, or personal injury when using your microwave oven, follow these basic safety precautions.
	Do NOT attempt.
	Do NOT disassemble.
	Do NOT touch.
	Follow directions explicitly.
	Unplug the power plug from the wall socket.
	Make sure the machine is grounded to prevent electric shock.
	Call the service center for help.
	Note

These warning signs are here to prevent injury to you and others.
Please follow them explicitly.

After reading this section, keep it in a safe place for future reference.

SAVE THESE INSTRUCTIONS

IMPORTANT SAFETY INSTRUCTIONS

When using any electrical appliance, basic safety precautions should be followed, including the following:



WARNING

To reduce risk of burns, electric shock, fire, personal injury or exposure to excessive microwave energy:

1. Read all safety instructions before using the appliance.
2. Use this appliance only for its intended uses as described in this manual.
3. Read and follow the specific "Precautions to Avoid Exposure to Excessive Microwave Energy" on this page.
4. This appliance must be grounded. Connect only to properly grounded outlets. See Important "Grounding Instructions" on page 5 of this manual.
5. Install or locate this appliance only in accordance with the provided installation instructions.
6. Some products such as whole eggs and sealed containers for example, closed glass jars are able to explode and should not be heated in this oven.
7. Use this appliance only for its intended use as described in the manual. Do not use corrosive chemicals or vapors in this appliance. This type of oven is specifically designed to heat, cook, or dry food. It is not designed for industrial or laboratory use.
8. As with any appliance, close supervision is necessary when used by children.
9. Do not operate this appliance if it has a damaged cord or plug, if it is not working properly, or if it has been damaged or dropped.
10. Never try to repair the oven on your own. This appliance should be repaired or serviced only by qualified service personnel. Contact the nearest authorized service facility for examination, repair, or adjustment.
11. Do not cover or block any openings on the appliance.
12. Do not tamper with or make any adjustments or repairs to the door.
13. Do not store this appliance outdoors. Do not use this product near water for example, near a kitchen sink, in a wet basement, near a swimming pool, or similar locations.
14. Do not immerse cord or plug in water.
15. Keep cord away from heated surfaces. (including the back of the oven).
16. Do not let cord hang over edge of table or counter.
17. When cleaning surfaces of door and oven that comes together on closing the door, use only mild, nonabrasive soaps, or detergents applied with a sponge or soft cloth. Unplug the plug before cleaning.
18. To reduce the risk of fire in the oven cavity.
 - a. Do not overcook food. Carefully attend appliance when paper, plastic, or other combustible materials are placed inside the oven to facilitate cooking.
 - b. Remove wire twist-ties from paper or plastic bags before placing bag in oven.
 - c. If materials inside the oven ignite, keep oven door closed, turn oven off, and disconnect the power cord, or shut off power at the fuse or circuit breaker panel. If the door is opened, the fire may spread.
 - d. Do not use the cavity for storage purposes. Do not leave paper products, cooking utensils, or food in the cavity when not in use.
19. Liquids, such as water, milk, coffee, or tea are able to be overheated beyond the boiling point without appearing to be boiling. Visible bubbling or boiling when the container is removed from the microwave oven is not always present. **THIS COULD RESULT IN VERY HOT LIQUIDS SUDDENLY BOILING OVER WHEN THE CONTAINER IS DISTURBED OR A SPOON OR OTHER UTENSIL IS INSERTED INTO THE LIQUID.** To reduce the risk of injury to persons:
 - a. Do not overheat the liquid.
 - b. Stir the liquid both before and halfway through heating it.
 - c. Do not use straight-sided containers with narrow necks.
 - d. After heating, allow the container to stand in the microwave oven for a short time before removing the container.
 - e. Use extreme care when inserting a spoon or other utensil into the container.

SAVE THESE INSTRUCTIONS

20. Clean Ventilating Hoods Frequently - Grease should not be allowed to accumulate on hood of filter.
21. When flaming foods under the hood, turn the fan on.
22. Use care when cleaning the vent-hood filter. Corrosive cleaning agent, such as lye-based oven cleaner, may damage the filter.



CAUTION

1. Clean Ventilating Hoods Frequently - Grease should not be allowed to accumulate on hood of filter.
2. When flaming foods under the hood, turn the fan on.
3. Use care when cleaning the vent-hood filter. Corrosive cleaning agent, such as lye-based oven cleaner, may damage the filter.

GROUNDING INSTRUCTIONS

This appliance must be grounded. In the event of an electrical short circuit, grounding reduces the risk of electric shock by providing an escape wire for the electrical current. This appliance is equipped with a cord that includes a grounding wire and a grounding plug. The plug must be plugged into an outlet that is properly installed and grounded.



WARNING

Improper use of the grounding plug can result in a risk of electric shock.

- Plug into a grounded 3 prong outlet. Do not remove the third (grounding) prong. Do not use an adaptor or otherwise defeat the grounding plug.
- Consult a qualified electrician or service person if you do not understand the grounding instructions or if you are not sure if the appliance is properly grounded.
- We do not recommend using an extension cord with this appliance. If the power-supply cord is too short, have a qualified electrician or serviceman install an outlet near the appliance. However, if it is necessary to use an extension cord, read and follow the "Use of Extension Cords" section below.

Use of Extension Cords

A short power-supply cord is provided to reduce the risk of becoming entangled in or tripping over a longer cord. Longer cord sets or extension cords are available and may be used if care is exercised in their use. If a long cord or extension cord is used:

1. The marked electrical rating of the cord set or extension cord should be at least as great as the electrical rating of the appliance.
2. The extension cord must be a grounding-type 3-wire cord and it must be plugged into a 3-slot outlet.
3. The longer cord should be arranged so that it will not drape over the counter top or tabletop where it can be pulled on by children or tripped over accidentally. If you use an extension cord, the interior light may flicker and the blower may vary when the microwave oven is on. Cooking times may be longer, too.

SAVE THESE INSTRUCTIONS



SEVERE WARNING SIGNS FOR INSTALLATION



The installation of this appliance must be performed by a qualified technician or service company.

- Failing to do so may result in electric shock, fire, an explosion, problems with the product, or injury.

Unpack oven, remove all packaging material and examine the oven for any damages such as dents on the interior or exterior of the oven, broken door latches, cracks in the door, or a door that is not lined up correctly. If there is any damage, do not operate the oven and notify your dealer immediately.

Remove all foreign substances such as dust or water from the power plug terminals and contact points using a dry cloth on a regular basis.

- Unplug the power plug and clean it with a dry cloth.
- Failing to do so may result in electric shock or fire.

Plug the power cord into a properly grounded outlet of standard. Your oven should be the only connected on this circuit.

- Sharing a wall socket with other appliances using a power strip or extending the power cord may result in electric shock or fire.
- Do not use an electric transformer. It may result in electric shock or fire.
- Ensure that the power voltage, frequency and current are the same as those of the product specifications. Failing to do so may result in electric shock or fire.

Keep all packaging materials out of the reach of children. Children may use them for play.



This appliance must be properly grounded. Read and follow the specific "Grounding Instructions" found in the beginning of this Section.

Do not ground the appliance to a gas pipe, plastic water pipe, or telephone line.

- This may result in electric shock, fire, an explosion, or problems with the product
- Never plug the power cord into a socket that is not grounded correctly and make sure that it is in accordance with local and national codes.

Do not cut or remove the third (ground) prong from the power cord under any circumstances.

Connect the oven to a 20A circuit. When connecting the oven to a 15A circuit, make sure that circuit breaker is operable.



Do not install this appliance in a humid, oily or dusty location, in a location exposed to direct sunlight and water (rain drops).

- This may result in electric shock or fire.

Plug the power plug into the wall socket firmly. Do not use a damaged power plug, damaged power cord or loose wall socket.

- This may result in electric shock or fire.

Do not operate any other heating or cooking appliance beneath this appliance.

Do not mount unit over or near any portion of a heating or cooking appliance.

Do not mount over a sink.

Do not pull or excessively bend the power cord.

Do not twist or tie the power cord.

Do not hook the power cord over a metal object, place a heavy object on the power cord, insert the power cord between objects, or push the power cord into the space behind the appliance.

- This may result in electric shock or fire.

Do not pull the power cord, when unplugging the power plug.

SAVE THESE INSTRUCTIONS

-  - Unplug the power plug by holding the plug.
- Failing to do so may result in electric shock or fire.

-  When the power plug or power cord is damaged, contact your nearest service center.



CAUTION SIGNS FOR INSTALLATION

-  This appliance should be positioned in such a way that it is accessible to the power plug.
 - Failing to do so may result in electric shock or fire due to electric leakage.

-  Unplug the power plug when the appliance is not being used for long periods of time or during a thunder/lightning storm.

- Failing to do so may result in electric shock or fire.



SEVERE WARNING SIGNS FOR USING

-  If the appliance is flooded please contact your nearest service center : Failing to do so may result in electric shock or fire.

Read and follow the specific "Precautions to Avoid Possible Exposure to Excessive Microwave Energy", found in the beginning of this Section.

If the appliance generates a strange noise, a burning smell or smoke, unplug the power plug immediately and contact your nearest service center.

- Failing to do so may result in electric shock or fire.

In the event of a gas leak (such as propane gas, LP gas, etc.), ventilate immediately without touching the power plug. Do not touch the appliance or power cord.

- Do not use a ventilating fan.
- A spark may result in an explosion or fire.

Take care that the door or any of the other parts do not come into contact with the body while cooking or just after cooking.

- Failing to do so may result in burns.

In the event of a grease fire on the surface units below the oven, smother a flaming pan on the surface unit by covering the pan completely with a lid, a cookie sheet or a flat tray.

Never leave surface units beneath your oven unattended at high heat settings. Boilovers cause smoking and greasy spillovers that may ignite and spread if the vent fan is operating. To minimize automatic fan operation, use adequate sized cookware and use high heat on surface units only when necessary.

If materials inside oven should ignite, keep the oven door closed, turn the oven off and disconnect the power cord, or shut off power at the fuse or circuit breaker panel. If the door is opened, the fire may spread.

Always observe Safety Precautions when using your oven. Never try to repair the oven on your own - there is dangerous voltage inside. If the oven needs to be repaired, contact an authorized service center near you.

-  Do not attempt to repair, disassemble, or modify the appliance yourself.
 - Since a high voltage current enters the product chassis, it may result in electric shock or fire.
 - You may be exposed to electromagnetic waves.
 - When repairing the appliance is required, contact your nearest service center.

SAVE THESE INSTRUCTIONS



If any foreign substance such as water has entered the appliance, unplug the power plug and contact your nearest service center.

- Failing to do so may result in electric shock or fire.



Do not touch the power plug with wet hands.

- This may result in electric shock.

Do not turn the appliance off by unplugging the power plug while an operation is in progress.

- Plugging the power plug into the wall socket again may cause a spark and result in electric shock or fire.

Keep all packaging materials well out of the reach of children, as packaging materials can be dangerous to children.

- If a child places a bag over its head, it may result in suffocation.

Do not let children or any person with reduced physical, sensory or mental capabilities use this appliance unsupervised.

Make sure that the appliance is out of the reach of children.

- Failing to do so may result in electric shock, burns or injury.

Do not touch the inside of the appliance immediately after cooking, because the inside of the appliance is hot after being heated for a long time or heating a small amount of food.

- Failing to do so may result in burns.

Do not use aluminum foil, metal objects (such as containers, forks, etc.) or containers with golden or silver rims.

- This may result in sparks or fire.

Do not use or place inflammable sprays or objects near the oven.

- This may result in fire or an explosion.

Do not insert fingers, foreign substances or metal objects such as pins or needles into the inlet, outlet, water supply cartridge input and output parts, and holes. If foreign substances are inserted into any of these holes, unplug the power plug from the wall socket and contact your product provider or nearest service center.

- Failing to do so may result in electric shock or injury.

Do not tamper with or make any adjustments or repairs to the door. Under no circumstances should you remove the outer cabinet.

Do not store or use oven outdoors.



CAUTION SIGNS FOR USING



When the surface is cracked, turn the power switch of the appliance off.

- Failing to do so may result in electric shock.

Dishes and containers can become hot. Handle with care.

Hot foods and steam can cause burns. Carefully remove container coverings, directing steam away from hands and face.

Remove lids from baby food before heating. After heating baby food, stir well to distribute the heat evenly. Always test temperature by tasting before feeding the baby. The glass jar or surface of the food may appear to be cooler than the interior, which can be so hot as to burn the infant's mouth.

Make sure all cookware used in the oven is suitable for microwaving.

Use microwavable cookware in strict compliance with such manufacturers recommendations.

SAVE THESE INSTRUCTIONS

 Do not stand on top of the appliance or place objects (such as laundry, oven cover, lighted candles, lighted cigarettes, dishes, chemicals, metal objects, etc.) on the appliance.

- Items, such as a cloth, may be caught in the door.
- This may result in electric shock, fire, problems with the product, or injury.

Do not operate the appliance with wet hands.

- This may result in electric shock.

Do not spray volatile material such as insecticide onto the surface of the appliance.

- As well as being harmful to humans, it may also result in electric shock, fire or problems with the product.

Do not place the appliance over a fragile object such as a sink or glass object.

- This may result in damage to the sink or glass object.

Do not put your face or body close to the appliance while cooking or when opening the door just after cooking.

- Take care that children do not come too close to the appliance.
- Failing to do so may result in children burning themselves.

Do not place food or heavy objects over the door when opening the door.

- The food or object may fall and this may result in burns or injury.

Do not abruptly cool the door, the inside of the appliance, or the dish by pouring water over it during or just after cooking.

- This may result in damage to the appliance. The steam or water spray may result in burns or injury.

Do not try to preheat oven or operate while empty.

Do not cook without the glass tray in place on the oven floor. Food will not cook properly without the tray.

Do not defrost frozen beverages in narrow-necked bottles. The containers can break.

Do not scratch the glass of the oven door with a sharp object.

- This may result in the glass being damaged or broken.

Do not store anything directly on top of the appliance when it is in operation.

Do not use sealed containers. Remove seals and lids before use. Sealed containers can explode due to buildup of pressure even after oven has been turned off.



SEVERE WARNING SIGNS FOR CLEANING

Do not clean the appliance by spraying water directly onto it.

Do not use benzene, thinner or alcohol to clean the appliance.

- This may result in discoloration, deformation, damage, electric shock or fire.

Before cleaning or performing maintenance, unplug the appliance from the wall socket and remove food waste from the door and cooking compartment.

- Failing to do so may result in electric shock or fire.

Take care not to hurt yourself when cleaning the appliance (external/internal)

- You may hurt yourself on the sharp edges of the appliance.

Do not clean the appliance with a steam cleaner.

- This may result in corrosion.

Keep the inside of the oven clean. Food particles or spattered oils stuck to the oven walls or floor can cause paint damage and reduce the efficiency of the oven.

SAVE THESE INSTRUCTIONS

contents

SETTING UP YOUR NEW MICROWAVE OVEN	12	Checking the parts
	13	Setting up your microwave oven
	16	Turning on the power for the first time
	16	Setting the time
	16	Child lock
	17	My settings

USING YOUR MICROWAVE OVEN	18	Using the Kitchen Timer button
	18	Using the add 30 sec. button
	18	Using the More/Less button
	18	Using the hi/mid/lo/off Vent button
	19	Using the Vent delay off button
	19	Using the Light hi/LO/off button
	19	Using the Light timer button
	20	Using the Turntable On/Off button
	20	Using the metal shelf
	21	Using the Sensor CookING button

COOKWARE GUIDE	30	Microwave-safe utensils
-----------------------	-----------	-------------------------

COOKING GUIDE	32	General microwave tips
	33	Cooking meat
	34	Cooking poultry
	34	Cooking seafood
	35	Cooking eggs
	35	Cooking vegetables
	36	Recipes

**CLEANING AND MAINTAINING YOUR
MICROWAVE OVEN**

38

- 38 Cleaning the exterior
- 38 Cleaning the interior
- 38 Cleaning the turntable and roller rings
- 39 Storing and repairing your microwave oven
- 39 Replacing the cooktop/night bulb
- 39 Replacing the oven bulb
- 40 Cleaning the grease filter
- 41 Replacing the charcoal filter

TROUBLESHOOTING

42

- 42 Check these points if your microwave oven

APPENDIX

43

- 43 Specifications

WARRANTY

44

setting up your new microwave oven

Be sure to follow these instructions closely so that your new microwave oven works properly.

CHECKING THE PARTS

Carefully unpack your microwave oven, and make sure you've received all parts shown below. If your microwave oven was damaged during shipping, or if you do not have the parts, contact Samsung Customer Service (Refer to the "WARRANTY AND SERVICE INFORMATION" on page 44).

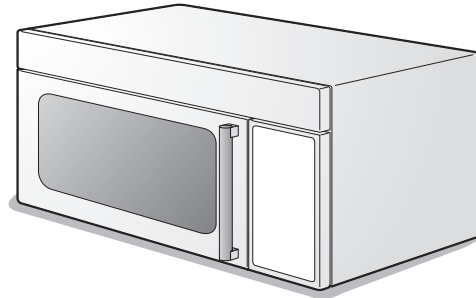

Microwave oven (SMH9207)

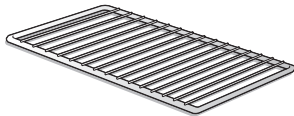

Shelf

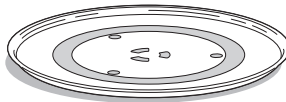

Glass Tray



Roller Guide Ring

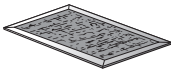

Grease Filters (2ea)

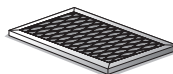

Charcoal filter

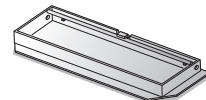

Exhaust adaptor



Hardware kit (Screws & Brackets)

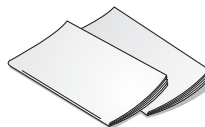

Manuals (User & Installation)

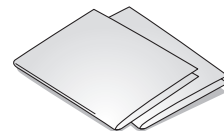

Templates (Top & Wall)

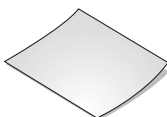

Registration Card

SETTING UP YOUR MICROWAVE OVEN

1. Open the door by pulling the handle on the right side of the door.
2. Wipe the inside of the oven with a "damp cloth".

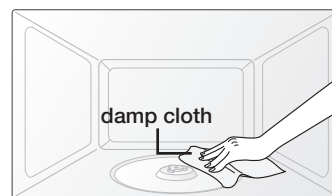

3. Install the "pre-assembled roller ring" into the "indentation" at the center of the microwave oven.

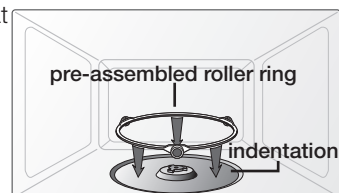

4. Place the "glass tray" securely in the center of the "pre-assembled roller ring".

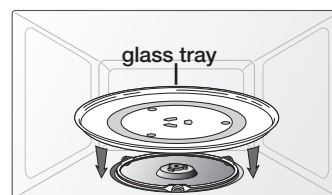

Installing the metal shelf

When you need to use the Metal Shelf, place it on the plastic hooks inside your oven and make sure it is positioned properly to avoid arcing and damaging your oven.



CAUTION Make sure the shelf is positioned properly inside the microwave to prevent damage to the oven from arcing.

setting up your new microwave oven

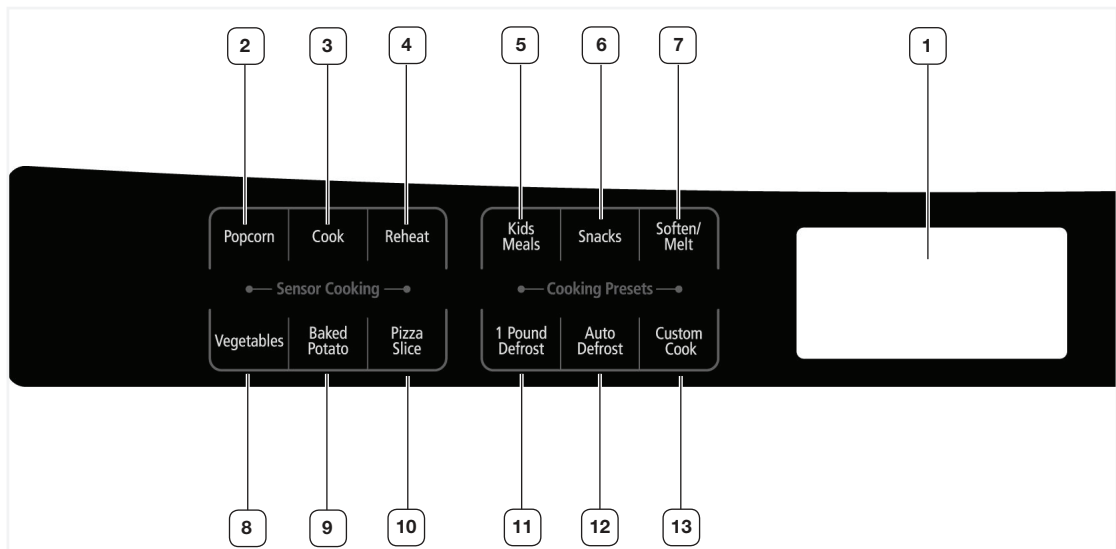

1 DISPLAY	The display includes clock and indicators to tell you the time of day, cooking time settings and cooking functions selected.
2 POPCORN	Press this button when popping popcorn in your microwave oven. The oven's sensor will tell the oven how long to cook depending on the amount of humidity it detects from the popcorn.
3 COOK	Press this button to cook a beverage, frozen dinner, frozen breakfast, chicken breast. The oven's sensor will tell the oven how long to cook depending on the amount of humidity coming from the food.
4 REHEAT	Press this button to reheat a dinner plate, casserole, and pasta. The oven's sensor will tell the oven how long to cook depending on the amount of humidity coming from the food.
5 KIDS MEALS	Press this button to cook chicken nuggets, hot dogs, French fries and frozen sandwiches.
6 SNACKS	Press this button to cook nachos, chicken wings, potato skins and cheese sticks.
7 SOFTEN/MELT	Press this button to cook melt chocolate, soften cream cheese and melt butter.
8 VEGETABLES	Press this button to cook fresh or frozen vegetables. The oven's sensor will tell the oven how long to cook depending on the amount of humidity it detects from the vegetables.
9 BAKED POTATO	Press this button to cook potatoes. The oven's sensor will tell the oven how long to cook depending on the amount of humidity it detects from the potato.
10 PIZZA SLICE	Press this button to reheat pizza. The oven's sensor will tell the oven how long to cook depending on the amount of humidity it detects.
11 1POUND DEFROST	Press this button to defrost 1 pound of frozen food.
12 AUTO DEFROST	Press this button to defrost food by weight.
13 CUSTOM PROGRAM	Press this button to recall one cooking instruction previously programmed into memory.
14 LESS(1)	Press this button to subtract the cooking time.

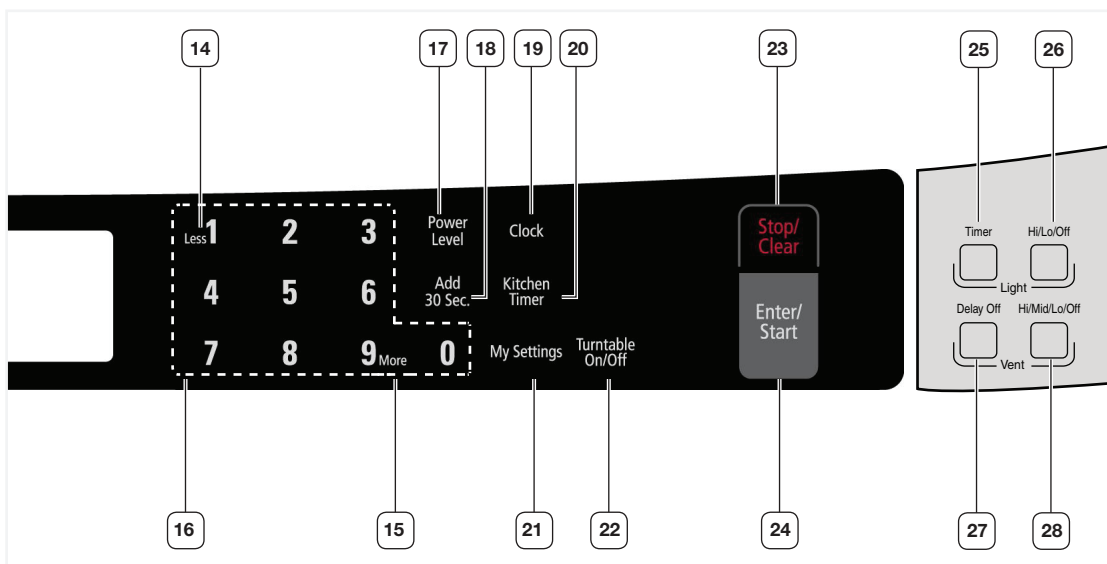

15 MORE(9)	Press this button to add more cooking time.
16 NUMBER	Press number buttons to enter cooking time, power level, quantity or weight.
17 POWER LEVEL	Press this button to select a cooking power level.
18 ADD 30 SEC.	Press this button on to set and start cooking quickly at 100% power level. You can also use this button while cooking is in progress to add 30 seconds to the cooking time.
19 CLOCK	Press this button to enter the time of day.
20 KITCHEN TIMER	Press this button to set the kitchen timer.
21 MY SETTINGS	Press this button to change the oven's default settings.
22 TURNTABLE ON/OFF	Press this button to turn off the turntable. OFF will appear in the display. <ul style="list-style-type: none"> • Turntable On/Off is not available in sensor cook and defrost modes. • If you want to turn On, Press this button again.
23 STOP/CLEAR	Press this button to stop the oven or to clear all entries.
24 ENTER/START	Press this button to start a function. If you open the door after the oven begins to cook, close the door and press the Enter/Start button again.
25 LIGHT TIMER	Press this button to set the light timer.
26 LIGHT HI/LO/OFF	Press this button to turn on the cooktop light. <ul style="list-style-type: none"> • If you press the button, light will be changed (Hi » Lo » Off).
27 VENT DELAY OFF	Press this button when setting the ventilation time (1, 3, 5, 10, 30 minutes).
28 VENT HI/MID/LO/OFF	Press this button to turn the fan on/off.

 Refer to “Using your microwave oven” on the next page for detailed information on the buttons described in the table above.

setting up your new microwave oven

TURNING ON THE POWER FOR THE FIRST TIME

The first time you plug the power cord into an outlet, the display turns on after four seconds with: *PLEASE TOUCH CLOCK AND SET TIME OF DAY.*

 This will also occur after a power interruption.

SETTING THE TIME (19)

Your microwave oven is equipped with a built-in clock. Set the clock when first installing your microwave oven and after a power failure. The time is displayed whenever the microwave oven is not being used.

1. Press the **Clock** button.
2. The display will show *ENTER TIME OF DAY.*
3. Use the Number buttons to enter the current time. You need to press at least three numbers to set the clock. For example, if the current time is 5:00, press 5, 0, 0. The display will show: *500.*
4. Press the **Enter / Start** button again.
5. The display will show *AM TOUCH1 PM TOUCH2.*
6. Use the Number buttons to select AM / PM.
7. Press the **Enter / Start** button again.
8. A colon appears indicating that the time is set.

 To check the time while cooking, press the **Clock** button.

CHILD LOCK (24)

The Child Lock function allows you to lock the buttons so that the microwave oven cannot be operated accidentally. The oven can be locked anytime. This function can prevent to wrong operating by children.

Activating

1. Press the **Enter / Start** button for 3 seconds.
2. The display will show *CHILD LOCK ON.*

 When buttons do not respond, please check if the Child Lock function is on.

Deactivating

1. Press the **Enter / Start** button for 3 seconds.
2. The display will show *CHILD LOCK OFF.*



Do not let children or infirm persons use this microwave oven unsupervised.
- Failing to do so may result in electric shock, burns or injury.

MY SETTINGS (21)

Your new microwave oven can be customized to suit your personal preferences. Simply press the **My SETTINGS** button to configure the following options. The options are summarized in the following table:

No.	Function	Description
1	Weight mode selected	1 Lbs. 2 Kg
2	Sound on/off control	1 Sound ON 2 Sound OFF
3	Clock display control	1 12HR 2 24HR
4	Display	1 Slow speed 2 Normal speed 3 Fast speed
5	Remind end signal	1 ON 2 OFF
6	Demo mode	1 ON 2 OFF
7	Daylight Saving time	1 ON 2 OFF

using your microwave oven

Cooking has never been easier than with your new Samsung microwave oven.

The following section describes everything you need to know about using your microwave oven.

USING THE KITCHEN TIMER BUTTON (20)

This microwave allows you to use your microwave oven as a timer. Use the Kitchen Timer for timing up to 99 minutes, 99 seconds.

1. Press the **Kitchen Timer** button.
2. Use the Number buttons to set the length of time you want the timer to run.
3. Press **Enter / Start** button.
4. The display counts down and beeps when the time has elapsed.
5. To cancel timer setting: Press **Stop/Clear** button once.

USING THE ADD 30 SEC. BUTTON (18)

This simplified control saves you time, letting you quickly start cooking at 100% power without the need to press the **Start** button.

1. Press the **Add 30 sec.** button for each 30 seconds you wish the food to be cooked for. For example, press it twice to cook it for one minute. The time is displayed and the oven starts automatically.
2. Add 30 sec. to a cooking program already in progress by pressing the **Add 30 sec.** button for every additional 30 seconds you wish to add.

USING THE MORE/LESS BUTTON (14, 15)

The **More (9)/Less (1)** button allow you to adjust the pre-set cooking times. They only work for the “Sensor Reheat”, “Sensor Cooking(except Beverage)”, “Add 30 sec.”, “Custom Cook”, “Kitchen Timer”, “Soften/Melt”, “Kids Meals”, “Snack Bar” and “Time Cook” modes. Use the **More (9)/Less (1)** button only after you have already begun cooking with one of these modes.

1. Use the **More (9)** button to add time to an automatic cooking procedure.
 2. Use the **Less (1)** button to decrease the time of an automatic cooking procedure.
-  Each time you press the More (9) button while cooking manually, the current cooking time increases by 10 seconds. Press the Less (1) button to decrease it by 10 seconds.

USING THE HI/MID/LO/OFF VENT BUTTON (28)

The vent removes steam and other vapors from the cooking surface. You can manually select the vent setting.

1. Press the **Vent Hi/Mid/Lo/Off** button once for high fan speed.
2. Press the **Vent Hi/Mid/Lo/Off** button twice for medium fan speed.
3. Press the **Vent Hi/Mid/Lo/Off** button three times for low fan speed.
4. Press the **Vent Hi/Mid/Lo/Off** button four times to turn the fan off.

-  If the temperature becomes too hot around the microwave oven, the fan in the vent hood will automatically turn on at the low speed setting to cool the oven. The fan will automatically turn off when the oven has cooled down sufficiently. This is an automated process and cannot be turned off. The fan may stay on for 30 minutes or more after the cooktop and microwave controls are turned off. The Vent Fan will only operate in low speed mode while the microwave is working.

USING THE VENT DELAY OFF BUTTON (27)

The button will be used to stop vent moter after passing constant time.

1. Press the **Delay Off** button once to turn the fan off after 1 minute.
2. Press the **Delay Off** button twice to turn the fan off after 3 minutes.
3. Press the **Delay Off** button three times to turn the fan off after 5 minutes.
4. Press the **Delay Off** button four times to turn the fan off after 10 minutes.
5. Press the **Delay Off** button five times to turn the fan off after 30 minutes.

USING THE LIGHT HI/LO/OFF BUTTON (26)

The **Light** button allows you to select a light setting for your microwave.

1. Press the **Light Hi/Lo/Off** button once for high light.
2. Press the **Light Hi/Lo/Off** button twice for low light.
3. Press the **Light Hi/Lo/Off** button three times to turn the light off completely.

USING THE LIGHT TIMER BUTTON (25)

The microwave can be set so the light turns on and off automatically at a preset time. The light comes on at the same time every day until reset.

1. Press the **Light Timer** button.
2. Use the Number buttons to set the light on time.
3. Press the **Enter / Start** button.
4. Use the Number buttons to select AM or PM.
5. Press the **Enter / Start** button.
6. Use the Number buttons to set the off time.
7. Press the **Enter / Start** button.
8. Use the Number buttons to select AM or PM.
9. Press the **Enter / Start** button.
10. Press the **Light Timer** button and "0" button to cancel the light timer.

USING THE TURNTABLE ON/OFF BUTTON (22)

For best cooking results, leave the turntable on. However, for large dishes it can be turned off. Press the **Turntable On/Off** button to turn the turntable on or off.

 The turntable may become too hot to touch. Use pot holders to touch the turntable during and after cooking.

USING THE METAL SHELF

Use the metal shelf to cook more than one item at the same time.



- Do not use a microwave browning dish on the shelf. The shelf could overheat.
- Do not use the oven with the shelf on the microwave floor. This could damage the microwave.
- Use pot holders when handling the shelf as it may be hot.
- Do not use the metal shelf when cooking popcorn.

Food cooks best on the turntable.

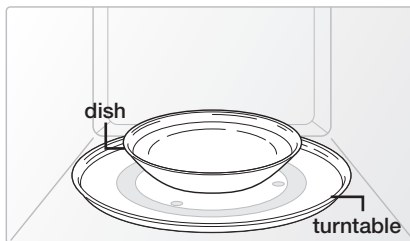

For best results

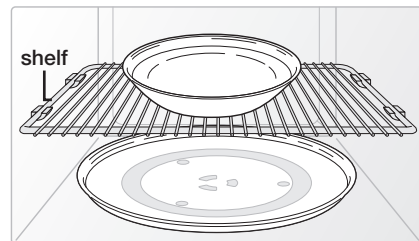

Uneven results

The shelf gives you the option to reheat more than one dish at the same time.

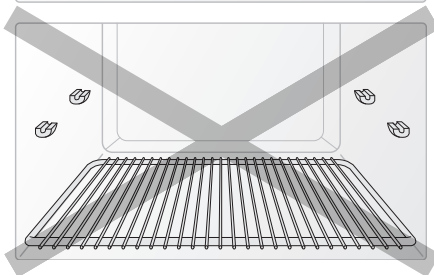
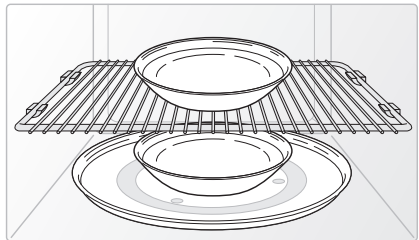
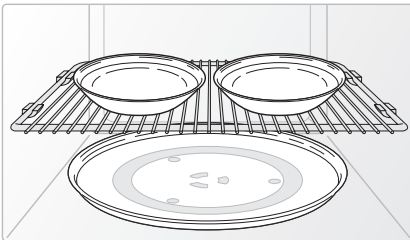

Reheating food

To reheat food on 2 levels or to reheat food on the lower level:

- Multiply the reheating time by 1½.
- Switch places halfway through the reheating process.

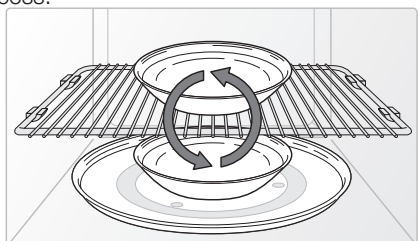
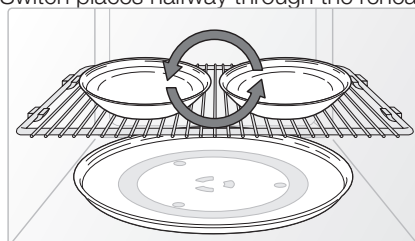

using your microwave oven

USING THE SENSOR COOKING BUTTON

The **Sensor Cooking** button consist of frequently used settings, allowing you to select it quickly and conveniently. Use the **More (9)/Less (1)** button to set your temperature preference. If the food is not thoroughly cooked or reheated when using the auto cook feature, complete the cooking process by selecting a power level and cooking time.

 Do not continuously use the **Sensor Cooking** button. The oven must cool for 5 minutes between uses or the food will overcook.

Sensor cooking utensils & covers

To obtain good cooking results using these functions, follow the directions for selecting the appropriate containers and covers in the Cookware section on p30.

Always use microwave-safe containers and cover with a lid or plastic wrap. When using plastic wrap, turn back one corner to allow steam to escape.

 Always use the proper lid for the container. If the utensil does not have its own lid, use plastic wrap.

 Fill containers at least half full.

 Foods that require stirring or rotating should be stirred or turned at the end of the Sensor Cook cycle, when the time has started to count down on the display.

 Do not use the Auto Sensor cooking feature continuously. Wait 5 minutes before selecting another sensor cooking operation.

 To avoid poor results, do not use the Auto Sensor when the room ambient temperature is too high or too low.

Sensor cooking table

FOOD		AMOUNT	PROCEDURE
Popcorn (2)		3.0 - 3.5 oz. 1 package	Use only one microwave popcorn bag at a time. Be careful when removing and opening the heated bag from the oven. Let the oven cool for at least 5 minutes before using it again.
Cook (3)	Beverage	8 oz.	Use a measuring cup or mug and do not cover. Place the beverage in the oven. After heating, stir well. Let the oven cool for at least 5 minutes before using it again.
	Frozen dinner	8 to 14 oz.	Remove the food from its wrapping and follow the instructions on the box for covering and standing instructions. Let the oven cool for at least 5 minutes before using it again.
	Frozen breakfast	4 to 8 oz.	Follow the package instructions for covering and standing. Use this button for frozen sandwiches, breakfast entrees, pancakes, waffles, etc. Let the oven cool for at least 5 minutes before using it again.
	Chicken breast	8 to 16 oz.	Place the chicken breasts on a microwave safe plate and cover with plastic wrap. Cook to an internal temperature of 170 °F. Let stand for 5 minutes. Use the More (9) button to increase the cooking time for larger or thicker chicken breasts.
Vegetable (8)	Fresh	1 to 4 servings	Place the fresh vegetables in a microwave-safe ceramic, glass or plastic dish and add 2-4 tbs. water. Cover with a lid or vented plastic wrap while cooking and stir before standing. Let the oven cool for at least 5 minutes before using it again.
	Frozen	1 to 4 servings	Place the frozen vegetables in a microwave-safe ceramic, glass or plastic dish and add 2-4 tbs. water. Cover with a lid or vented plastic wrap while cooking and stir before standing for 3-5 minutes. Let the oven cool for at least 5 minutes before using it again. Use the More (9) button when cooking dense vegetables such as carrots or broccoli spears.
Baked Potatoes (9)		1 to 6 potatoes	Pierce each potato several times with a fork. Place on the turntable in a spoke-like fashion. After cooking, let the potatoes stand for 3-5 minutes. Let the oven cool for at least 5 minutes before using it again.
Pizza Slice (10)		1 to 3 slices	Place 1-3 pizza slices on a microwave-safe plate with the wide ends of the slices towards the outside edge of the plate. Do not let the slices overlap. Do not cover. Let the oven cool for at least 5 minutes before using it again. Use the More (9) button to increase the reheating time for pizzas with thick crusts.

The correct food temperature varies from person to person. Use the **More (9)/Less (1)** button to select your personal temperature preference.

using your microwave oven

USING THE REHEAT BUTTON (4)

Heating leftovers and precooked foods is easy with your new microwave. By actually sensing the humidity that escapes as the food is heated, the oven's heating time is automatically adjusted depending on the type and amount of precooked food.

 All foods must already be precooked. Plates of foods and casseroles should be stored at refrigerator temperature.

Press the **Reheat** button to begin reheating your precooked food. The display will show *SELECT MENU 1 TO 3* and the oven will start automatically. Use the **More (9)/Less (0)** button to adjust the heating time. If you want to check the current time at anytime while reheating, press the **Clock** button.

Sensor reheating table

Follow the instructions below when reheating different types of food.

FOOD	AMOUNT	PROCEDURE
Dinner plate	1 serving (1 plate)	Use only precooked, refrigerated foods. Cover the plate with vented plastic wrap or waxed paper tucked under the plate. If the food is not as hot as you would like after using the " Sensor Reheat " function, continue heating using additional time and power. Contents: 3-4 oz. meat, poultry or fish (up to 6 oz. with bone) ½ cup starch (potatoes, pasta, rice, etc.) ½ cup vegetables (about 3 - 4 oz.)
Casserole	1 to 4 servings	Cover the plate with a lid or vented plastic wrap. If the food is not as hot as you would like after using the " Sensor Reheat " function, continue heating using additional time and power. Stir the food once before serving. Contents: Casserole, refrigerated foods.
Pasta	1 to 4 servings	canned spaghetti and ravioli

USING THE AUTO DEFROST BUTTON (12)

To thaw frozen foods, enter the weight of the food, and the microwave automatically sets the defrosting time, power level and standing time. Press **Enter/Start** button to start defrosting.

1. Press the **Auto Defrost** button. The display shows: *ENTER WEIGHT*.
2. Press the number buttons to directly enter the weight of the food. The oven calculates the defrosting time and starts automatically.
3. Press **Enter/Start** button to start defrosting.
4. The oven will beep and the display will read *TURN THE FOOD OVER* twice during the defrosting process. Open the oven door, and turn the food over.

Auto defrosting table

Follow the instructions below when defrosting different types of food.

FOOD	AMOUNT	PROCEDURE
Roast Beef, Pork	2.5-6.0 lbs.	Start with the food placed fat side down. After each stage, turn the food over and shield any warm portions with narrow strips of aluminum foil. Let stand, covered for 10-20 minutes.
Steaks, Chops, Fish	0.5-3.0 lbs.	After each stage, rearrange the food. If there are any warm or thawed portions of food, shield them with narrow, flat pieces of aluminum foil. Remove any pieces of food that are nearly defrosted. Let stand, covered for 5-10 minutes.
Ground Meat	0.5-3.0 lbs.	After each stage, remove any pieces of food that are nearly defrosted. Let stand, covered with foil for 5-10 minutes.
Whole Chicken	2.5-6.0 lbs.	Remove giblets before freezing poultry. Start defrosting with the breast side down. After the first stage, turn the chicken over and shield any warm portions with narrow strips of aluminum foil. After the second stage, again shield any warm portions with narrow strips of aluminum foil. Let stand, covered for 30-60 minutes in the refrigerator.
Chicken Pieces	0.5-3.0 lbs.	After each stage, rearrange or remove any pieces of food that are nearly defrosted. Let stand for 10-20 minutes.

-  Check the food when you hear the oven signal. After the final stage, small sections may still be icy; let them stand to continue the thawing process. Do not defrost until all ice crystals have thawed. Shielding roasts and pieces of steak using small pieces of aluminum foil prevents the edges from being cooked before the center of the food has defrosted. Use narrow, flat, smooth strips of foil to cover edges and thinner sections of the food.

USING THE 1 POUND DEFROST BUTTON (11)

To thaw frozen 1.0 lbs foods, press this button, and the microwave automatically sets the defrosting time, power level and standing time.

1. Press the **1 Pound Defrost** button. The display shows: *1.0 LB*.
2. Press **Enter/Start** button to start defrosting.
3. The oven will beep and the display will read *TURN THE FOOD OVER* twice during the defrosting process. Open the oven door, and turn the food over.
4. If you do not turn the food over when *TURN THE FOOD OVER* is displayed, the oven will be paused until the **Enter/Start** button is pressed.

using your microwave oven

USING THE SOFTEN / MELT BUTTON (7)

1. Press the **Soften/Melt** button. The display will show: *SELECT MENU 1 TO 3* (Refer to the Soften/Melt table). Press the button repeatedly to cycle through the available items.
2. Press the number **1** or **2** button to select the serving size. Only number **1** (serving) is available for the Melt Chocolate and Soften Cream Cheese options (Refer to the Soften/Melt table for the serving size).
3. Press the **Start** button to begin cooking.





Soften / Melt table

ITEM	AMOUNT	REMARKS
Melt chocolate	1 cup chips or 1 square	Place the chocolate chips or squares in a microwave-safe container. When the oven beeps, stir the chocolate and restart the oven. Stir and let stand for 1 minute.
Soften cream cheese	8-oz. package	Unwrap the cream cheese and place on a microwave-safe container. Cut in half vertically. Let stand for 2 minutes.
Melt butter	1 stick (serving) 2 sticks (serving)	Remove the wrapping and cut the butter in half vertically. Place the butter in a dish and cover with wax paper. Stir well after finishing and let stand for 1-2 minutes.

USING THE KIDS MEALS BUTTON (5)

1. Press the **Kids Meals** button. The display will show *SELECT MENU 1 TO 4* (Refer to the Kids meals table). Press the button repeatedly to cycle through the available items.
2. Press the number **1** or **2** buttons to select the serving size (Refer to the Kids meals table for the serving size).
3. Press the **Start** button to begin cooking.

Kids meals table

ITEM	AMOUNT	REMARKS
Chicken nuggets (frozen)	1 serving 2 servings	Place a paper towel on a plate and arrange the nuggets in a spoke-like fashion on the paper towel. Do not cover. Let stand for 1 minute after heating.  Refer to the package directions for the serving size and the amount of food. Use the More (9) button to add additional cooking time if the chicken nuggets are not hot enough.
Hot dogs	2 hot dogs 4 hot dogs	Pierce the hot dogs and place them on a plate. When the oven beeps, add the buns and restart the oven. Let stand for 1 minute after heating.  For the best texture, the buns should be added to the hot dogs when the oven beeps.
French fries (frozen)	1 serving 2 servings	Place two paper towels on a microwave-safe plate and arrange the french fries on the towels without letting them overlap. Blot the fries with additional paper towels after removing from the oven. Let stand for 1 minute.  refer to the directions on the packaging for the serving size and the amount of food.
Frozen sandwiches (in crisping sleeve) 9-oz. package size	1 sandwich 2 sandwiches	Place the frozen sandwich in a susceptor "crisping sleeve" (which is in a package) and place on a microwave-safe plate. Remove from the "crisping sleeve". Let stand for 2 minutes after heating.  For large sandwiches, use the More (9) button to increase the heating time.

using your microwave oven

USING THE SNACKS BUTTON (6)

1. Press the **Snacks** button. The display will show *SELECT MENU 1 TO 4* (Refer to the snack bar table) Press the button repeatedly to cycle through the available items.
2. Press the number **1** or **2** buttons to select the serving size. Only number **1** (serving) is available for Nachos (Refer to the snack bar table for the serving size).
3. Press the **Start** button to begin cooking.

Snack bar table

ITEM	AMOUNT	REMARKS
Nachos	1 serving	Place the nachos on a plate without letting them overlap. Sprinkle cheese evenly over them. Contents: 2 cups tortilla chips 1/3 cup grated cheese
Chicken wings	5-6 oz. 7-8 oz.	Use precooked, refrigerated chicken wings. Place the chicken wings around the plate in a spoke-like fashion and cover with wax paper. Let stand for 1 to 2 minutes.
Potato skins	1 cooked potato 2 cooked potatoes	Cut the cooked potato into 4 even wedges. Scoop or cut out the potato flesh, leaving about a 1/4 in. of skin. Place the skins in a spoke-like fashion around the plate. Sprinkle with bacon, onions and cheese. Do not cover. Let stand 1 to 2 minutes.
Cheese sticks (frozen)	5-6 pcs 7-10 pcs	Place the cheese sticks on a plate in a spoke-like fashion. Do not cover. Let stand for 1 to 2 minutes after heating.  The sizes of the cheese sticks may vary. For smaller size cheese nuggets, use the Less (1) button to decrease the heating time. For larger size cheese sticks, use the More (9) button to increase the heating time.

MICROWAVE COOKING TIMES & POWER LEVELS

Your oven allows you to set three different cooking stages, each with their own time length and power level. Multi-stage cooking will make you to be convenient. And you can customize the cooking. The power level lets you control the heating intensity from Warm (1) through to High (0).

Power Levels

The 10 power levels allow you to choose the optimal power level for your cooking needs.

POWER LEVEL			
1	Warm	6	Simmer
2	Low	7	Medium high
3	Defrost	8	Reheat
4	Medium low	9	Sauté
5	Medium	0	High

One-stage cooking

By using the number buttons, you only need to set the cooking time for simple one-stage cooking. The power level is automatically set to High. If you want to set the power level to any other levels, use the **Power Level** button.

1. Use the number buttons to set a cooking time. You can enter a time from one second right up to 99 minutes and 99 seconds. To select a time greater than one minute, enter the seconds too (For example, to set a cooking time of 20 minutes, enter **2, 0, 0, 0**).
2. If you want to set the power level to a level other than High, press the **Power Level** button and use the number buttons to enter the power level. The display will show: *PRESS START OR ENTER NEXT STAGE COOKING TIME*.
3. Press the **Start** button to begin cooking. If you want to change the power level, press the **Stop/Clear** button before you press the **Start** button, and enter all instructions again.

 Some recipes require different cooking stages at different temperatures. Your microwave allows you to set multiple cooking stages.

Multi-stage cooking

Each cooking stage has setting time and power level separately. Your oven can operate up to third cooking stage.

1. Follow steps 1 and 2 from the “One-stage cooking” section. The display will show: *PRESS START OR ENTER NEXT STAGE COOKING TIME* appears in the display.

 When selecting more than one cooking stage, the **Power Level** button must be pressed before the second cooking stage can be entered.

 Press the **Power Level** button twice to set the power level to High for a cooking stage.

2. Use the number buttons to set a second cooking time.
3. Press the **Power Level** button, then use the number buttons to set the power level for the second cooking stage. The display shows the selected power level and then displays *PRESS START OR ENTER NEXT STAGE COOKING TIME*.
4. Press the **Start** button to begin cooking, or repeat steps 2 and 3 to set a cooking time and power level for a third cooking stage. When finished, press the **Start** button.

using your microwave oven

USING THE CUSTOM COOK BUTTON (13)

The **Custom Cook** button lets you store a customized set of cooking instructions, and recall this setting later from memory to begin cooking quickly.

 Only one set of instructions can be stored at a time.

1. Press the **Custom Cook** button. The display shows *TOUCH START OR ENTER NEW TIME*.
2. Use the number buttons to enter the cooking time. The display will show the set time.
3. Press the **Power Level** button and use the number buttons to enter the power level. The display will show the selected power level. You can set the power level from 0 to 9.
4. Press the **Enter/Start** button again.
5. To retrieve a Custom Recipe, press the **Custom Cook** button, then press the **Enter/Start** button.
 - You can only recall one stored recipe at a time.

 You can check the power level anytime while cooking by pressing the **Power Level** button.

cookware guide

To cook food in the microwave oven, the microwaves must be able to penetrate the food without being reflected or absorbed by the dish.

It is important to choose the correct cookware, therefore look for cookware that is marked microwave-safe. The following table lists various types of cookware and indicates if and how they should be used in a microwave oven.

MICROWAVE-SAFE UTENSILS

If you are not sure whether an item is microwave-safe or not, you can perform the following simple test:

1. Place 1 cup of water (in a glass-measuring cup) inside your oven next to the item to be tested.
2. Press the **Add 30 Sec.** button twice to heat them both for one minute at high power.

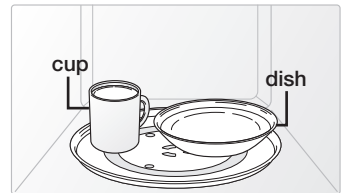

After one minute, the water should be warm and the item you are testing should be cool. If the dish is warm, then it is absorbing microwave energy and is not microwave-safe.

COOKWARE	MICROWAVE-SAFE	COMMENTS
Aluminum foil	Use Caution	Can be used in small quantities to protect areas against overcooking. Arcing can occur if the foil is too close to the oven wall or if too much foil is used.
Browning plate	Recommended	Do not preheat for more than eight minutes.
Ceramic, porcelain, and stoneware	Recommended	Porcelain, pottery, glazed earthenware and bone china are usually suitable, unless decorated with a metal trim.
Disposable polyester cardboard	Recommended	Some frozen foods are packaged in these materials.
Fast-food packaging		
Polystyrene cups/containers	Recommended	Can be used to warm food. Overheating may cause the polystyrene to melt.
Paper bags or newspaper	Unsafe	May catch fire.
Recycled paper or metal trims	Unsafe	May cause arcing.
Glassware		
Oven-to-table ware	Recommended	Can be used, unless decorated with a metal trim.
Fine glassware	Recommended	Can be used to warm foods or liquids. Delicate glass may break or crack if heated suddenly.
Glass jars	Recommended	Regular glass is too thin to be used in a microwave, and can shatter.
Metal		
Dishes, Utensils	Unsafe	May cause arcing or fire.
Freezer bag twist ties	Unsafe	

COOKWARE	MICROWAVE-SAFE	COMMENTS
Paper Plates, cups, napkins and kitchen paper Recycled paper	Recommended Recommended	For short cooking times and warming. Also to absorb excess moisture. Do not use recycled paper towels, which may contain metal and may catch fire or cause arcing.
Plastic Containers Cling film Freezer bags	Recommended Recommended Use Caution	Can be used if heat-resistant thermoplastic. Some plastics may warp or discolor at high temperatures. Do not use Melamine plastic. Can be used to retain moisture. Avoid wrapping the food too tight. Take care when removing the film as hot steam will escape. Only if boilable or oven-proof. Should not be airtight. Pierce with a fork, if necessary.
Wax or grease-proof paper	Recommended	Can be used to retain moisture and prevent spattering.
Thermometer	Recommended	Use only those marked "Microwave-safe" and follow the directions. Check the temperature in several places. Conventional thermometers can be used once the food has been removed from the oven.
Straw, wicker, and wood	Use Caution	Use only for short-term heating, as these materials can be flammable.

cooking guide

Microwave energy actually penetrates food, attracted and absorbed by the water, fat and sugar content. The microwaves cause the molecules in the food to move rapidly. The rapid movement of these molecules creates friction and the resulting heat cooks the food.

GENERAL MICROWAVE TIPS

Dense foods, such as potatoes, take longer to heat than lighter foods. Foods with a delicate texture should be heated at a low power level to avoid becoming tough.

Foods with a non-porous skin such as potatoes or hot dogs, should be pierced to prevent bursting. Putting heating oil or fat in the microwave is not recommended. Fat and oil can suddenly boil over and cause severe burns.

Some ingredients heat faster than others. For example, the jelly in the jelly doughnut will be hotter than the dough. Keep this in mind to avoid burns.

The altitude and the type of cookware you are using can affect the cooking time. When using a new recipe, use the minimum cooking time and check the food occasionally to prevent overcooking.

Home canning in the microwave oven is not recommended because not all harmful bacteria may be destroyed by the microwave heating process.

Although microwaves do not heat the cookware, the heat from the food is often transferred to the cookware. Always use pot holders when removing food from the microwave and instruct children to do the same.

Making candy in the microwave is not recommended as candy can be heated to very high temperatures. Keep this in mind to avoid injury.

Cooking techniques

 If the oven is set to cook for more than 25 minutes, it will automatically adjust to 70 percent power after 25 minutes to avoid overcooking.

Stirring

Stir foods such as casseroles and vegetables while cooking to distribute heat evenly. Food at the outside of the dish absorbs more energy and heats more quickly, so stir from the outside towards the center. The oven will turn off when you open the door to stir your food.

Arrangement

Arrange unevenly shaped foods, such as chicken pieces or chops, with the thicker, meatier parts toward the outside of the turntable where they receive more microwave energy. To prevent overcooking, place thin or delicate parts towards the center of the turntable.

Shielding

Shield food with narrow strips of aluminum foil to prevent overcooking. Areas that need shielding include poultry wing-tips, the ends of poultry legs, and corners of square baking dishes. Use only small amounts of aluminum foil. Larger amounts can damage your oven.

Turning

Turn foods over midway through the cooking cycle to expose all parts to the microwave energy. This is especially important with large items such as roasts.

Standing

Foods cooked in the microwave build up internal heat and continue to cook for a few minutes after the oven stops. Let foods stand to complete the cooking process, especially foods such as roasts and whole vegetables. Roasts need this time to complete cooking in the center without overcooking the outer areas. All liquids, such as soup or hot chocolate should be shaken or stirred when cooking is complete. Let liquids stand a moment before serving. When heating baby food, stir well and test the temperature before serving.

Adding moisture

Microwave energy is attracted to water molecules. Food that is uneven in moisture content should be covered or allowed to stand so that the heat disperses evenly. Add a small amount of water to dry food to help it cook.

Venting

After covering a dish with plastic wrap, vent the plastic wrap by turning back one corner to let excess steam escape.

COOKING MEAT

Place the meat fat side down on a microwave-safe roasting rack in a microwave-safe dish. Use narrow strips of aluminum foil to shield any bone tips or thin pieces of meat. Check the temperature in several places before letting the meat stand the recommended time.

The following temperatures are the removal temperatures. The temperature of the food will rise during standing time.

FOOD	COOKING TIME/POWER LEVEL	INSTRUCTIONS
Roast beef (boneless) Up to 4 lbs.	Cooking Time: 7-11 min. / lb. for 145 °F - Rare 8-12 min. / lb. for 160 °F - Medium 9-14 min. / lb. for 170 °F - Well Done	Place the roast fat-side down on the roasting rack and cover with wax paper. Turn over halfway through the cooking process. Let stand for 10 to 15 minutes.
	Power Level: High (0) for first 5 minutes, then Medium (5).	
Pork (boneless or bone-in) Up to 4 lbs.	Cooking Time: 11-15 min. / lb. at 170 °F Well Done	Place the roast fat-side down on the roasting rack and cover with wax paper. Turn over halfway through cooking process. Let stand for 10 to 15 minutes.
	Power Level: High (0) for first 5 minutes, then Medium (5).	

Expect a 10 °F rise in temperature during the standing time.

FOOD		REMOVE FROM OVEN	AFTER STANDING (10 MIN.)
Beef	Rare	135 °F	145 °F
	Medium	150 °F	160 °F
	Well Done	160 °F	170 °F
Pork	Medium	150 °F	160 °F
	Well Done	160 °F	170 °F
Poultry	Dark meat	170 °F	180 °F
	Light meat	160 °F	170 °F

COOKING POULTRY

Place the poultry on a microwave-safe roasting rack in a microwave-safe dish and cover with wax paper to prevent spattering. Use aluminum foil to shield the bone tips, thin pieces of meat, or areas that may start to overcook.

Check the temperature in several places before letting the poultry stand the recommended time.

FOOD	COOKING TIME/POWER LEVEL	INSTRUCTIONS
Whole chicken Up to 4 lbs.	Cooking Time: 6-9 min. / lb. 180 °F dark meat 170 °F light meat	Place the chicken breast-side down on the roasting rack. Cover with wax paper. Turn over half way through cooking process. Cook until the juices run clear and the meat near the bone is no longer pink. Let stand for 5-10 minutes.
	Power Level: Medium High (7).	
Chicken pieces Up to 2 lbs.	Cooking Time: 6-9 min. / lb. 180 °F dark meat 170 °F light meat	Place the chicken bone-side down on the dish, with the thickest portions towards the outside of the dish. Cover with wax paper. Turn over halfway through the cooking process. Cook until the juices run clear and the meat near the bone is no longer pink. Let stand for 5-10 minutes.
	Power Level: Medium High (7).	

COOKING SEAFOOD

Place the fish on a microwave-safe roasting rack in a microwave-safe dish. Use a tight cover to steam the fish. A lighter cover of wax paper or paper towel will decrease steaming. Cook the fish until it flakes easily with a fork. Do not overcook fish; check it after the minimum cooking time.

FOOD	COOKING TIME/POWER LEVEL	INSTRUCTIONS
Tuna steaks and salmon steaks Up to 1.5 lbs.	Cooking Time: 6-10 min. / lb.	Arrange the steaks on a roasting rack with the meaty portions towards the outside of the rack. Cover with wax paper. Turn them over halfway through the cooking process. Cook until the fish flakes easily with a fork. Let stand for 3-5 minutes.
	Power Level: Medium-High (7).	
Fillets Up to 1.5 lbs.	Cooking Time: 3-7 min. / lb.	Arrange the fillets in a baking dish, tucking any thin pieces under. Cover with wax paper. If the fillets are thicker than ½ in., turn them over halfway through the cooking process. Cook until the fish flakes easily with a fork. Let stand for 2-3 minutes.
	Power Level: Medium-High (7).	
Shrimp Up to 1.5 lbs.	Cooking Time: 3-5½ min. / lb.	Arrange the shrimp in a baking dish without overlapping or layering them. Cover with wax paper. Cook until firm and opaque, stirring 2 or 3 times. Let stand for 5 minutes.
	Power Level: Medium-High (7).	

cooking guide

COOKING EGGS

You can use your microwave oven to cook eggs. Cook them until they are just set as they become tough if they are overcooked.



WARNING Never cook eggs in their shells or the sphere shaped yolk, and never warm up hard-boiled eggs in their shells as they may explode. Always pierce whole eggs and break the yolk to keep them from bursting.

COOKING VEGETABLES

Vegetables should be washed prior to cooking. Usually, no extra water is needed. If dense vegetables such as potatoes, carrots and green beans are being cooked, add about ¼ cup water.

Small vegetables (sliced carrots, peas, lima beans, etc.) will cook faster than larger ones.

Whole vegetables, such as potatoes, acorn squash or corn on the cob, should be arranged in a circle on the turntable before cooking. They will cook more evenly if turned over halfway through the cooking process.

Always place vegetables such as asparagus and broccoli with the stems pointing towards the edge of the dish and the tips toward the center.

When cooking cut vegetables, always cover the dish with a lid or vented microwavable plastic wrap.

Whole, unpeeled vegetables such as potatoes, squash, eggplant, etc., should have their skins pierced in several spots before cooking to prevent them from bursting.

For a more even cooking result, stir or rearrange whole vegetables halfway through the cook time.

Generally, the denser the food, the longer the standing time (The standing time refers to the time necessary for dense, large foods and vegetables to finish cooking after they come out of the oven). A baked potato can stand on the counter for five minutes before cooking is completed, while a dish of peas can be served immediately.

RECIPES

Beef and barley stew

1½ lbs. beef stew cubes, cut into ½-inch pieces
½ cup chopped onion
2 Tbs. all-purpose flour
1 Tbs. Worcestershire sauce
1 can (13.75-14.5 oz.) beef broth
2 medium carrots, cut into ½-inch slices (about 1 cup)
½ cup barley
1 bay leaf
¼ tsp. pepper
1 pkg. (9-10 oz.) frozen peas, thawed

1. In a 2-quart casserole, combine the beef, onion, flour, and Worcestershire sauce and mix well. Cover with lid. Cook at High for 6 to 8 minutes until the beef is no longer pink, stirring once.
2. Stir in beef broth, carrots, barley, bay leaves, and pepper. Cover with lid. Cook at Medium for 1 to 1½ hours until carrots and beef are tender, stirring 2 to 3 times.
3. Stir in peas. Cover with lid. Cook at Medium for 10 minutes. Let stand for 10 minutes. Remove bay leaves before serving.

Makes 6 servings.

Broccoli and cheese casserole

¼ cup butter or margarine
¼ cup chopped onion
1½ Tbs. flour
½ tsp. salt
¼ tsp. dry mustard
1/8 tsp. pepper
1½ cups milk
¼ cup chopped red pepper
8 oz. (2 cups) cheddar cheese, shredded
1 pkg. (9-10 oz.) frozen chopped broccoli, thawed
4 cups cooked spiral shaped pasta (8 oz. dry)

1. In a 2-quart casserole, cook butter and onion at High for 1 to 2 minutes until the onion is soft, stirring once.
2. Add flour, salt, mustard, and pepper; mix well. Cook at High for 30 to 60 seconds until mixture boils. Stir in milk until smooth.
3. Stir in red pepper. Cook at High for 2 to 3 minutes until mixture boils and thickens slightly, stirring twice. Stir in cheese until melted.
4. Add broccoli and pasta, mix well. Cover with lid. Cook at High for 4 to 6 minutes until heated through, stirring once. Stir before serving.

Makes 6 servings.

Warm potato salad

2 lbs. small red potatoes, cut into ½-inch pieces
4 slices bacon (uncooked), cut into ½-inch pieces
¼ cup chopped onion
2 tsp. sugar
1 tsp. salt
1 tsp. flour
½ tsp. celery seed
1/8 tsp. pepper
2½ Tbs. apple cider vinegar

1. In a 2-quart casserole, combine the potatoes and ¼ cup water. Cover with lid. Cook at High until the potatoes are tender (7-10 minutes); stir twice. Drain and set aside to cool slightly.
2. In a medium bowl, cook the bacon at High until crisp (2½-3½ minutes); stir once. Place the bacon on a paper towel. Reserve 1 Tbs. drippings.
3. Combine the drippings and onion. Cover with plastic wrap; turn a corner back to vent steam. Cook at High until tender (1½-2½ minutes); stir once.
4. Stir in sugar, salt, flour, celery seed, and pepper. Cook at High until mixture boils (30-40 seconds). Stir in vinegar and ½ cup water. Cook at High until liquid boils and thickens slightly (1-2 minutes); stir once. Add bacon to dressing. Pour dressing over potatoes. Stir well.

Makes 6 servings.

Black bean soup

1 cup chopped onion
1 clove garlic, minced
2 cans (15 oz. each) black beans, drained
1 can (14-16 oz.) stewed tomatoes, chopped
1 can (13.75-14.5 oz.) chicken broth
1 can (7-8.5 oz.) corn
1 can (4 oz.) chopped green chilies
1-2 tsp. ground cumin

1. Place the onion and garlic in a 3-quart casserole. Cover with lid. Cook at High for 2 to 4 minutes until tender.
2. Add one can of beans, and mash the beans with a fork. Add remaining ingredients and mix well.
3. Cook uncovered at High for 10 minutes; stir. Reduce power to Medium and cook for 5 minutes. Stir before serving.

Makes about 2 quarts.

cleaning and maintaining your microwave oven

Keeping your microwave oven clean improves its performance, wards off unnecessary repairs, and lengthens its life.

CLEANING THE EXTERIOR

It's best to clean spills on the outside of your microwave oven as they occur. Use a soft cloth and warm, soapy water. Rinse and dry.



Do not get water into the vents. Never use abrasive products or chemical solvents such as ammonia or alcohol as they can damage the appearance of your microwave.



Unplug the microwave plug before cleaning.

Cleaning under your microwave oven

Regularly clean grease and dust from the bottom of your microwave using a solution of warm water and detergent.

Cleaning the control panel

Wipe with a damp cloth and dry thoroughly. Do not use cleaning sprays, large amounts of soap and water, abrasives or sharp objects on the panel as it is easily damaged.

Cleaning the door and door seals

Always ensure that the door seals are clean and that the door closes properly. Take particular care when cleaning the door seals to ensure that no particles accumulate and prevent the door from closing correctly. Wash the glass door with very mild soap and water. Be sure to use a soft cloth to avoid scratching.



If steam accumulates inside or outside the oven door, wipe with a soft cloth. Steam can accumulate when operating the oven at high humidity and in no way indicates microwave leakage.

CLEANING THE INTERIOR



Ensure that the microwave oven has cooled down before cleaning it to avoid injury.



Remove the glass tray from the oven when cleaning the oven or tray. To prevent the tray from breaking, handle it with care and do not put it in water immediately after cooking. Wash the tray carefully in warm sudsy water or in the dishwasher.



Unplug the microwave plug before cleaning.

Clean the interior surfaces (oven cavity) of your microwave oven periodically to remove any splashes or stains. To remove hardened food articles and remove smells, place 2 cups of water (add lemon juice for extra freshness) in a four-cup measuring glass (why a 4-cup measuring glass) at High power for 5 minutes or until boiling. Let it stand in the oven for one or two minutes.

CLEANING THE TURNTABLE AND ROLLER RINGS

Clean the roller rings periodically and wash the turntable as required. The turntable can safely be washed in your dishwasher.

cleaning and maintaining your microwave oven

STORING AND REPAIRING YOUR MICROWAVE OVEN

If you need to store your microwave oven for a short or extended period of time, choose a dust-free, dry location. Dust and dampness may adversely affect the ability of the microwave parts.



WARNING Do not repair, replace or service any parts of your microwave oven yourself. Allow only a qualified service technician to perform repairs. If the oven is faulty and needs servicing, or you are in doubt about its condition, unplug the oven from the power outlet and contact your nearest service center.

Do not use the oven if the microwave oven is damaged, in particular when the door or door seals are damaged. This could be a broken hinge, a worn out seal or distorted/bent casing.

Do not remove the oven from its casing.

This microwave oven is for home use only and is not intended for commercial use.

REPLACING THE COOKTOP/NIGHT BULB



WARNING When replacing the cooktop/night light, make sure that you are wearing gloves to avoid injury from the heat of the bulb.

1. Unplug the oven or turn off the power at the main power supply.
2. Remove the bulb cover and mounting screw.
3. Replace bulb with 40 watt incandescent bulb.
4. Reassemble the bulb cover and mounting screw.
5. Turn the power back on at the main power supply.

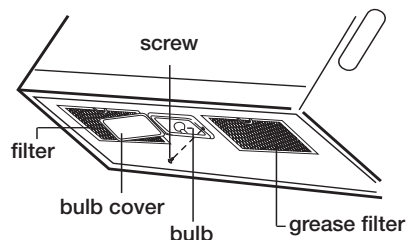

REPLACING THE OVEN BULB



WARNING When replacing the oven light, make sure that you are wearing gloves to avoid injury from the heat of the bulb.

1. Unplug the oven or turn off the power at the main power supply.
2. Remove the two screws holding the top vent grille in place.
3. Next, remove the top vent grille.
4. Remove the bracket duct upper by remove screw.
5. Replace the bulb with a 40 watt incandescent bulb.
6. Reassembly by reverse.

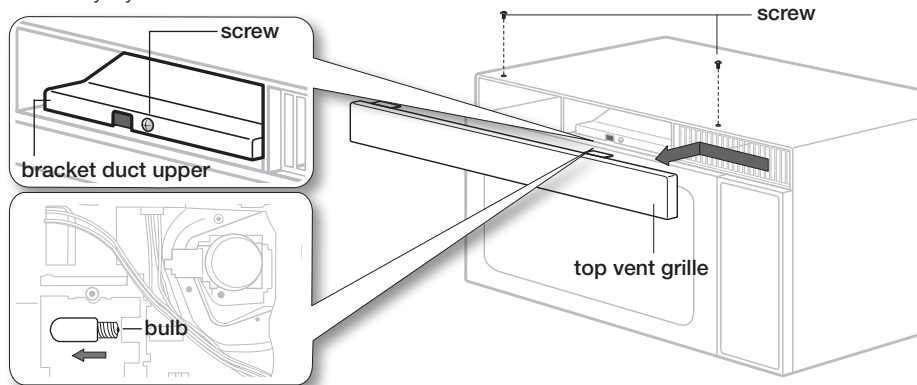

CLEANING THE GREASE FILTER

Your microwave oven has two metal reusable grease filters. The grease filters should be removed and cleaned at least once a month, or as required.



To avoid risk of personal injury or property damage, do not operate the oven hood without filters in place.

1. Catch the Tab on the grease filter.
2. Lift back the grease filter as shown in the fig.

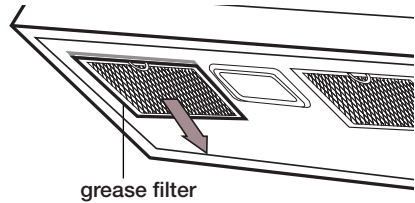

3. Pull the grease filter.

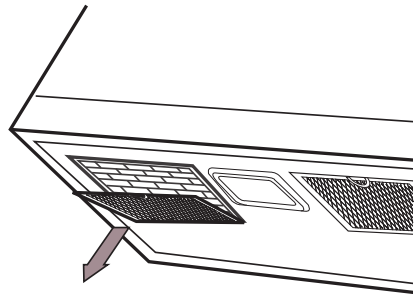

4. Separate the grease filter from the base bottom.
5. Reassembly by reverse.

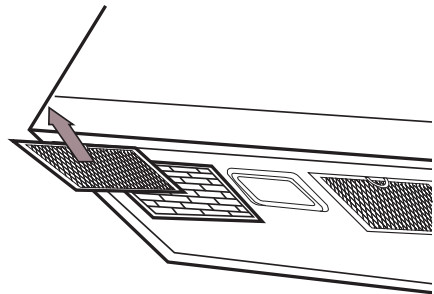

6. Soak the grease filter in hot water and a mild detergent. Rinse well and shake to dry. Brushing the filter lightly can remove embedded dirt.



Do not use ammonia or put the grease filter in the microwave oven. The aluminum will darken.

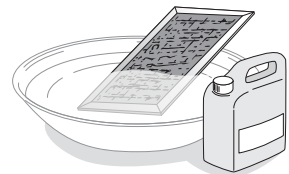

7. To return the filter to its position, slide it into the frame slot on the left (or right), then push it upwards and to the right (or left) to lock it.

cleaning and maintaining your microwave oven

REPLACING THE CHARCOAL FILTER

If your oven is not vented to the outside, the charcoal filter should be replaced when it is noticeably dirty or discolored (every 6 to 12 months, and more often if necessary). The charcoal filter cannot be cleaned. To order a new charcoal filter, contact the Parts Department at your nearest Authorized Service Center or Samsung dealer (**Charcoal filter part no.: DE63-00367D**).

1. Unplug the oven plug or turn off the power at the main power supply.
2. Remove the two screws from the top vent grille.
3. Remove the top vent grille following the procedure as shown in the fig.
4. 1) Push back and lift up the charcoal filter
2) Pull the charcoal filter straight out.
5. Assembling is in the reverse order to disassembling (it must be assembled duct-upper hook).

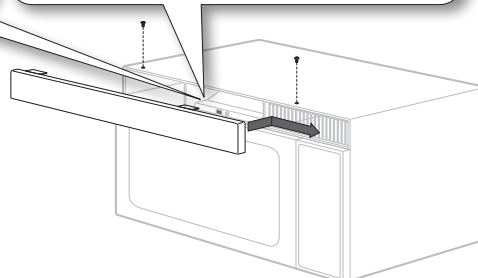
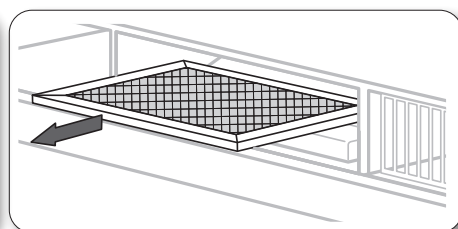
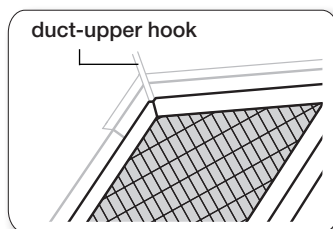
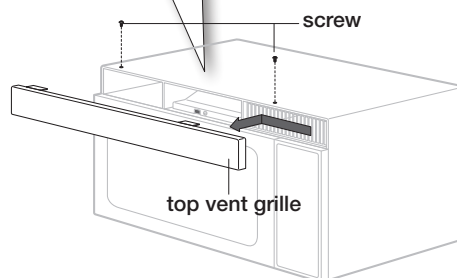
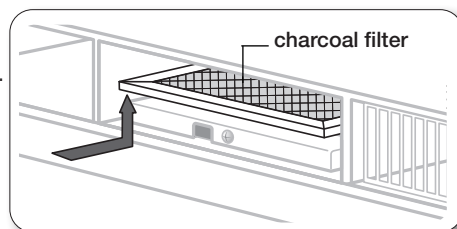

troubleshooting

CHECK THESE POINTS IF YOUR MICROWAVE OVEN...

PROBLEM	SOLUTION
The display and/or the oven is not working.	Make sure the plug is properly connected to a grounded outlet. If the wall outlet is controlled by a wall switch, make sure the wall switch is turned on. Remove the plug from the outlet, wait ten seconds, and plug it in again. Reset the circuit breaker or replace any blown fuses. Plug a different appliance into the outlet. If the other appliance doesn't work, call a qualified electrician to repair the wall outlet. Plug the oven into a different outlet.
The display is working, but the power won't come on.	Make sure the door is closed securely. Check if any packaging material or anything else is stuck in the door seal. Check if the door is damaged. Touch Cancel twice and enter all the cooking instructions again.
Is the power going off before the set time has elapsed?	If there was a power outage, the time indicator will display: 88:88. If no power outage occurred, remove the plug from the outlet, wait ten seconds, and plug it in again. Reset the clock and any cooking instructions. Reset the circuit breaker or replace any blown fuses.
Cooks food too slowly.	Make sure the oven has its own 20 amp circuit line. Operating another appliance on the same circuit can cause a voltage drop. If necessary, move the oven to its own circuit.
Has sparks or arcing.	Remove any metallic utensils, cookware, or metal ties. If using foil, use only narrow strips and allow at least one inch between the foil and the interior oven walls.
The turntable makes noise or becomes stuck.	Clean the turntable, roller ring and oven floor. Make sure the turntable and roller ring are positioned correctly.
Causes TV or radio interference.	This is similar to interference caused by other small appliances, such as hair dryers. Move your microwave (or appliance) away from appliances, such as your TV or radio.

appendix

SPECIFICATIONS

MODEL NUMBER	SMH9207ST
Oven Cavity	2.0 cuft
Controls	10 power levels, including defrost
Timer	99 minutes, 99 seconds
Power Source	120 VAC, 60 Hz
Power Consumption	1650 Watts
Power Output	1100 Watts
Cook top Light	40 Watts incandescent bulb
Oven Light	40 Watts incandescent bulb
Oven Cavity Dimensions	22 ¹ / ₃₂ "(W) X 10 ⁷ / ₈ "(H) X 14 ⁷ / ₈ "(D)
Outside Dimensions	29 ⁷ / ₈ "(W) X 16 ¹ / ₂ "(H) X 16 ¹ / ₂ "(D)
Shipping Dimensions	33 ³ / ₈ "(W) X 20 ⁵ / ₃₂ "(H) X 19 ¹³ / ₃₂ "(D)
Net/Shipping Weight	52.7/60.6 lbs

warranty

WARRANTY AND SERVICE INFORMATION

To help us to serve you better, please complete the enclosed registration card and promptly return it by mail. If the registration card is missing, you can call Samsung Electronics, Inc., at **1-800-SAMSUNG (726-7864)** or register online at **www.samsung.com/global/register**. When contacting Samsung, please provide the specific model and serial number information which is usually located on the back or bottom of the product. Please record these numbers below, along with the other requested information. Keep this information in a safe place as a permanent record of your purchase to aid in identification in case of theft or loss, and a copy of your sales receipt as a proof of purchase if warranty service is needed.

MODEL NUMBER

SERIAL NUMBER

DATE PURCHASED

PURCHASED FROM

Warranty service can only be performed by a Samsung Authorized Service Center. If you should require warranty service, provide the above information with a copy of your sales receipt to the Samsung Authorized Service Center.

For service assistance and the location of the nearest service center, please call **1-800-SAMSUNG (7267864)**.

SAMSUNG OVER-THE-RANGE(OTR) MICROWAVE OVEN

Limited warranty to original purchaser

This SAMSUNG brand product, as supplied and distributed by Samsung Electronics America, Inc. (SAMSUNG) and delivered new, in the original carton to the original consumer purchaser, is warranted by SAMSUNG against manufacturing defects in materials and workmanship for a limited warranty period of:

ONE (1) YEAR PARTS AND LABOR, TEN (10) YEARS PARTS WARRANTY FOR MAGNETRON

This limited warranty begins on the original date of purchase, and is valid only on products purchased and used in the United States. To receive warranty service, the purchaser must contact SAMSUNG for problem determination and service procedures. Warranty service can only be performed by a SAMSUNG authorized service center. The original dated bill of sale must be presented upon request as proof of purchase to SAMSUNG or SAMSUNG's authorized service center.

SAMSUNG will repair this product or replace it if cannot repair it, at our option and at no charge as stipulated herein, with new or reconditioned parts or products if found to be defective during the limited warranty period specified above. All replaced parts and products become the property of SAMSUNG and must be returned to SAMSUNG. Replacement parts and products assume the remaining original warranty, or ninety (90) days, whichever is longer.

In-home service will be provided during the warranty labor period subject to availability within the contiguous United States. In-home service is not available in all areas. To receive in-home service, the product must be unobstructed and accessible to service personnel. If during in-home service repair can not be completed, it may be necessary to remove, repair and return the product. If in-home service is unavailable, SAMSUNG may elect, at our option, to provide for transportation of our choice to and from a SAMSUNG authorized service center. Otherwise, transportation to and from the SAMSUNG authorized service center is the responsibility of the purchaser.

This limited warranty covers manufacturing defects in materials and workmanship encountered in normal, noncommercial use of this product and shall not apply to the following, including, but not limited to: damage which occurs in shipment; delivery and installation; applications and uses for which this product was not intended; altered product or serial numbers; cosmetic damage or exterior finish; accidents, abuse, neglect, fire, water, lightning or other acts of nature; use of products, equipment, systems, utilities, services, parts, supplies, accessories, applications, installations, repairs, external wiring or connectors not supplied or authorized by SAMSUNG which damage this product or result in service problems; incorrect electrical line voltage, fluctuations and surges; customer adjustments and failure to follow operating instructions, cleaning, maintenance and environmental instructions that are covered and prescribed in the instruction book; problems caused by pest infestations, and overheating or overcooking by user; glass tray or turntable; reduced magnetron power output related to normal aging. SAMSUNG does not warrant uninterrupted or error-free operation of the product.

THERE ARE NO EXPRESS WARRANTIES OTHER THAN THOSE LISTED AND DESCRIBED ABOVE, AND NO WARRANTIES WHETHER EXPRESS OR IMPLIED, INCLUDING, BUT NOT LIMITED TO, ANY IMPLIED WARRANTIES OF MERCHANTABILITY OR FITNESS FOR A PARTICULAR PURPOSE, SHALL APPLY AFTER THE EXPRESS WARRANTY PERIODS STATED ABOVE, AND NO OTHER EXPRESS WARRANTY OR GUARANTY GIVEN BY ANY PERSON, FIRM OR CORPORATION WITH RESPECT TO THIS PRODUCT SHALL BE BINDING ON SAMSUNG. SAMSUNG SHALL NOT BE LIABLE FOR LOSS OF REVENUE OR PROFITS, FAILURE TO REALIZE SAVINGS OR OTHER BENEFITS, OR ANY OTHER SPECIAL, INCIDENTAL OR CONSEQUENTIAL DAMAGES CAUSED BY THE USE, MISUSE OR INABILITY TO USE THIS PRODUCT, REGARDLESS OF THE LEGAL THEORY ON WHICH THE CLAIM IS BASED, AND EVEN IF SAMSUNG HAS BEEN ADVISED OF THE POSSIBILITY OF SUCH DAMAGES. NOR SHALL RECOVERY OF ANY KIND AGAINST SAMSUNG BE GREATER IN AMOUNT THAN THE PURCHASE PRICE OF THE PRODUCT SOLD BY SAMSUNG AND CAUSING THE ALLEGED DAMAGE. WITHOUT LIMITING THE FOREGOING, PURCHASER ASSUMES ALL RISK AND LIABILITY FOR LOSS, DAMAGE OR INJURY TO PURCHASER AND PURCHASER'S PROPERTY AND TO OTHERS AND THEIR PROPERTY ARISING OUT OF THE USE, MISUSE OR INABILITY TO USE THIS PRODUCT SOLD BY SAMSUNG NOT CAUSED DIRECTLY BY THE NEGLIGENCE OF SAMSUNG. THIS LIMITED WARRANTY SHALL NOT EXTEND TO ANYONE OTHER THAN THE ORIGINAL PURCHASER OF THIS PRODUCT, IS NONTRANSFERABLE AND STATES YOUR EXCLUSIVE REMEDY.

Some states do not allow limitations on how long an implied warranty lasts, or the exclusion or limitation of incidental or consequential damages, so the above limitations or exclusions may not apply to you. This warranty gives you specific legal rights, and you may also have other rights which vary from state to state.

To obtain warranty service, please contact SAMSUNG at:

1-800-SAMSUNG (7267864) and www.samsung.com

memo

memo



QUESTIONS OR COMMENTS

COUNTRY	CALL	OR VISIT US ONLINE AT
CANADA	1-800-SAMSUNG(726-7864)	www.samsung.com/ca
MEXICO	01-800-SAMSUNG(726-7864)	www.samsung.com/mx
U.S.A	1-800-SAMSUNG(726-7864)	www.samsung.com/us

Code No.: DE68-03686A-02

Free Manuals Download Website

<http://myh66.com>

<http://usermanuals.us>

<http://www.somanuals.com>

<http://www.4manuals.cc>

<http://www.manual-lib.com>

<http://www.404manual.com>

<http://www.luxmanual.com>

<http://aubethermostatmanual.com>

Golf course search by state

<http://golfingnear.com>

Email search by domain

<http://emailbydomain.com>

Auto manuals search

<http://auto.somanuals.com>

TV manuals search

<http://tv.somanuals.com>