



Microwave Oven

Owner's Manual

SRH1230ZG

SRH1230ZW

SRH1230ZS

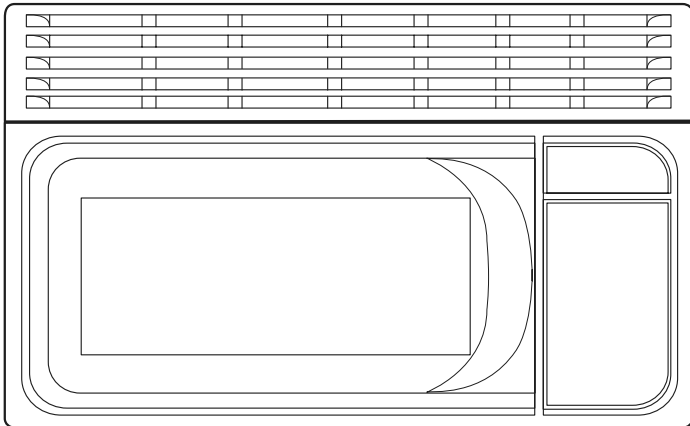

CODE NO. : DE68-02846A

Download from [Www.Somanuals.com](http://www.Somanuals.com). All Manuals Search And Download.



PRECAUTIONS TO AVOID POSSIBLE EXPOSURE TO EXCESSIVE MICROWAVE ENERGY:

- (a) Do not attempt to operate this oven with the door open since open-door operation can result in harmful exposure to microwave energy. It is important not to defeat or tamper with the safety interlocks.
- (b) Do not place any object between the front face of the oven and the door or allow soil or cleaner residue to accumulate on sealing surfaces.
- (c) Do not operate the oven if it is damaged. It is particularly important that the oven door close properly and that there is no damage to the
 - 1) Door (bent or dented),
 - 2) Hinges and latches (broken or loosened),
 - 3) Door seals and sealing surfaces.
- (d) The oven should not be adjusted or repaired by anyone except properly qualified service personnel.



WARNING

Always observe Safety Precautions when using your oven. Never try to repair the oven on your own – there is dangerous voltage inside. If the oven needs to be repaired, call 1-800-SAM-SUNG for the name of an authorized service center near you.

IMPORTANT SAFETY INSTRUCTIONS

When using any electrical appliance, basic safety precautions should be followed, including the following:



WARNING

To reduce risk of burns, electric shock, fire, personal injury or exposure to excessive microwave energy:

- Read all safety instructions before using the appliance.
- Read and follow the specific “Precautions to Avoid Possible Exposure to Excessive Microwave Energy” on this page.
- This appliance must be grounded. Connect only to properly grounded outlets. See “Important Grounding Instructions” on page 4 of this manual.
- Install or place this appliance only in accordance with the installation instructions provided.
- Some items, like whole eggs and food in sealed containers, may explode if heated in this oven.
- Use this appliance only for its intended use as described in the manual. Do not use corrosive chemicals or vapors in this appliance. This type of oven is specifically designed to heat, cook, or dry food. It is not designed for industrial or laboratory use.
- As with any appliance, close supervision is necessary when used by children.

SAVE THESE INSTRUCTIONS

Important Safety Instructions, continued

- Do not operate this appliance if it has a damaged cord or plug, if it is not working properly, or if it has been damaged.
- This appliance should be serviced only by qualified service personnel. Contact the nearest authorized service facility for examination, repair, or adjustment.
- Do not cover or block any of the openings on this appliance.
- Do not store this appliance outdoors. Do not use near water – for example, near a kitchen sink, in a wet basement, or near a swimming pool, etc.
- Keep the inside of the oven clean. Food particles or spattered oils stuck to the oven walls or floor can cause paint damage and reduce the efficiency of the oven.
- Do not immerse cord or plug in water.
- Keep cord away from heated surfaces.
- Do not let cord hang over edge of table or counter.
- When cleaning door and oven surfaces, use only mild, nonabrasive soaps or detergents applied with a sponge or soft cloth.
- To reduce the risk of fire in the oven:
 - a. Do not overcook food. Watch appliance carefully if paper, plastic, or other combustible materials are inside.
 - b. Remove wire twist-ties from plastic cooking bags before placing bags in oven.
 - c. If materials inside the oven ignite, keep the oven door closed, turn the oven off, disconnect the power cord, or shut off the power at the fuse or circuit breaker panel.
 - d. Do not use the oven compartment for storage purposes. Do not leave paper products, cooking utensils, or food in the oven when not in use.
- Do not try to preheat oven or operate while empty.
- Do not cook without the glass tray in place on the oven floor. Food will not cook properly without the tray.
- Do not defrost frozen beverages in narrow-necked bottles. The containers can break.
- Dishes and containers can become hot. Handle with care.
- Carefully remove container coverings, directing steam away from hands and face.
- Remove lids from baby food before heating. After heating baby food, stir well and test temperature by tasting before serving.
- Do not operate any other heating or cooking appliance beneath this appliance.
- Do not mount over a sink.
- Do not store anything directly on top of the appliance when it is in operation.
- This over-the-range oven was designed for use over ranges no wider than 42 inches. It may be installed over both gas and electric cooking equipment.

Important Grounding Instructions

This appliance must be grounded. In the event of an electrical short circuit, grounding reduces the risk of electric shock by providing an escape wire for the electric current. This appliance is equipped with a power cord having a grounding wire with a grounding plug. The plug must be plugged into an outlet that is properly installed and grounded.

SAVE THESE INSTRUCTIONS

Important Grounding Instructions



WARNING

Do not cut or remove the third (ground) prong from the power cord under any circumstances

This appliance must be grounded. In the event of an electrical short circuit, grounding reduces the risk of electric shock by providing an escape wire for the electric current. This appliance is equipped with a power cord having a grounding wire with a grounding plug. The plug must be plugged into an outlet that is properly installed and grounded.



WARNING

Improper use of the grounding plug can result in a risk of electric shock.

Consult a qualified electrician or servicer if you do not understand the grounding instructions or if you are not sure if the appliance is properly grounded.

Do not use an extension cord with this appliance. If the power cord is too short, have a qualified electrician or service technician install an outlet near the appliance.

Liquids, such as water, coffee, or tea are able to be overheated beyond the boiling point without appearing to be boiling. Visible bubbling or boiling when the container is removed from the microwave oven is not always present. **THIS COULD RESULT IN VERY HOT LIQUIDS SUDDENLY BOILING OVER WHEN UTENSIL IS INSERTED INTO THE LIQUID.**

To reduce the risk of injury to persons:

1. Do not overheat the liquid.
2. Stir the liquid both before and halfway through heating it.
3. Do not use straight-sided containers with narrow necks.
4. After heating, allow the container to stand in the microwave oven for a short time before removing the container.
5. Use extreme care when inserting a spoon or other utensil into the container.

THE VENT FAN

The fan will operate automatically under certain conditions (see page 14). Take care to prevent the starting and spreading of accidental cooking fires while the vent fan is in use.

- Clean the underside of the microwave often. Do not allow grease to build up on the microwave or the fan filters.
- In the event of a grease fire on the surface units below the microwave oven, smother a flaming pan on the surface unit by covering the pan completely with a lid, a cookie sheet or a flat tray.
- Use care when cleaning the vent fan filters. Corrosive cleaning agents, such as lye-based oven cleaners, may damage the filters.
- When preparing flaming foods under the microwave, turn the fan on.
- Never leave surface units beneath your microwave oven unattended at high heat settings. Boilovers cause smoking and greasy spillovers that may ignite and spread if the microwave vent fan is operating. To minimize automatic fan operation, use adequate sized cookware and use high heat on surface units only when necessary.

SAVE THESE INSTRUCTIONS

CONTENTS

Your New Microwave Oven	6	Using the Cooktop light	14
Checking Parts	6	Cooking Instructions	15
Setting Up Your Microwave Oven	6	Cooking Utensils	15
Optional Kit	6	Testing Utensils	15
Control Panel Buttons	7	Cooking Techniques	16
Operation	8	General Tips	16
Turning on the Power and Selecting a Display Language	8	Cooking Guides	17 -18
Setting the Clock	8	Auto Defrosting Guide	19
Using the Pause/Cancel Button	8	Recipes	20 - 21
Using the Instant Cook Buttons	9	Appendix	22
Using the One Minute +	10	Troubleshooting Guide	22
Reheating Automatically	10	Care and Cleaning	22
Defrosting Automatically	11	How to clean the outside	23
Setting and using the Custom Cook Button	11	Light bulb Replacement	23
Adjusting the Volume	12	Exhaust Feature	24
Using the Help System	12	Charcoal Filter	24
Setting Cooking Times & Power Levels . . 12		Warranty Information	25
One-stage Cooking	12	Specifications	25
Multi-stage Cooking	13	Manual Block Warranty	26
Using the More/Less Button	13	Guía Rápida(Spanish)	27
Using the Kitchen Timer	14	Quick ReferenceBack Cover
Setting the Child Protection Lock	14		
Demonstration Mode	14		
Using the Vent Fan	14		

YOUR NEW MICROWAVE OVEN

Checking Parts

Unpack your microwave oven and check to make sure that you have all the parts shown here. If any part is missing or broken, call your dealer.

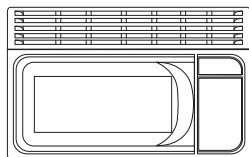

microwave oven



instruction installation



glass tray



hardware-kit



instruction manual



filter-grease



top template



wall mount-template



roller guide ring



charcoal filter



registration card

Thank You for Choosing Samsung

Your new oven represents the latest in microwave cooking technology. This oven is a full-featured, easy-to-use appliance built to strict quality standards set by Samsung — the highest in the industry. We're proud to offer you a product that will provide convenient, dependable service for years to come.

Please record the serial number from the inside or back of your Samsung microwave oven and the date of purchase in the space provided below. We recommend that you keep your purchase receipt with this manual for easy warranty service.

Model Number _____

Serial Number _____

Date Purchased _____

Dealer _____

Setting Up Your Microwave Oven

- 1 Plug the cord into a grounded outlet. Once plugged in, the display on your oven will show:



- 2 Open the oven door by pulling the handle on the right side of the door.
- 3 Wipe the inside of the oven with a damp cloth.
- 4 Place the pre-assembled ring in the indentation in the center of the oven.

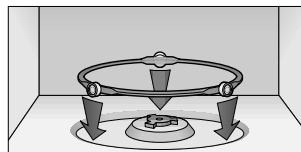

- 5 Place the glass tray on top of the ring so that the three glass tabs in the center of the tray fit securely into the tabs on the floor of the oven.

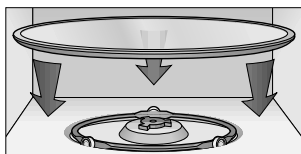

Optional Kit

Filter Kits

SMR-24 — Recirculating charcoal Filter Kit

Filter kits are used when the microwave oven cannot be vented to the outside.

Control Panel Buttons

Instant Cook Buttons

Instant settings to cook popular foods.

Custom Cook

Press twice to program your favorite recipe.
Press once to cook with that recipe.

Auto Reheat

Sets type of food to be reheated.

Auto Defrost

Sets weight of food to be defrosted.

One Minute +

Press once for every minute of cooking at High power.

Number Buttons

Sets cooking times or amounts.

Help Screen

Press to see help information about the feature you are using.

Power Level

Sets power to level other than high.

More/Less Button

Increases or decreases cooking time.

Kitchen Timer

Clock

Sets current time.

Pause/Cancel

Press to pause oven or correct a mistake.

Start

Press to start cooking.

Fan on/off

Press to turn on the vent fan.

Light on/off

Press to turn on the cooktop light.

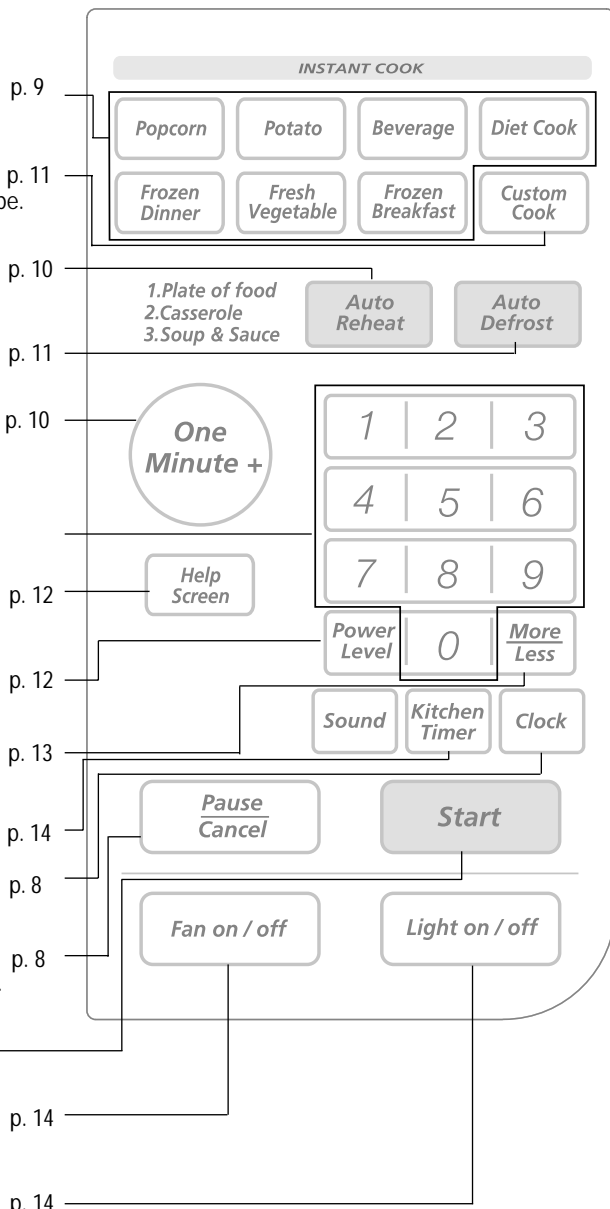

Turning on the Power and Selecting a Display Language

The first time you plug the power cord into an outlet, or after there has been an interruption in power, the display shows "SAMSUNG SO SIMPLE." At this point, you can select a language and weight system for the display. You can choose from English, French, Spanish and Portuguese and between pounds (LBS) or kilograms (KG). To do so,

- 1 Press **START** immediately after plugging in your Microwave. The display shows "ENGLISH/LBS". If the display does not show "ENGLISH/LBS", you will need to unplug the Microwave and then plug it in again to change the language.



- 2 Press **START** repeatedly to select the language and weight system you wish to use:
 - ENGLISH/LBS,
 - ENGLISH/KG,
 - FRENCH/KG,
 - SPANISH/LBS, or SPANISH/KG
 - PORTUGUESE/KG.
 If you continue to press **START**, the settings will cycle in the order shown here.



When you have selected the language and weight system you want to use, press the **PAUSE/CANCEL** button to end this procedure, or press **CLOCK** to set the clock.

Setting the Clock

- 1 Press the **Clock** button. The display will show:

SET CURRENT TIME

- 2 Use the number buttons to enter the current time. You must press at least three numbers to set the clock. If the current time is 5:00 enter, 5,0,0.

500

- 3 Press **Clock** again. A colon will appear, indicating that the time is set.

If there is a power interruption, you will need to reset the clock.

*You can check the current time while cooking is in progress by pressing the **Clock** button.*

Using the Pause/Cancel Button

The **Pause/Cancel** button allows you to clear instructions you have entered. It also allows you to pause the oven's cooking cycle, so that you can check the food.

- To pause the oven during cooking: press **Pause/Cancel** once. To restart, press **Start**.
- To stop cooking, erase instructions, and return the oven display to the time of day: press **Pause/Cancel** twice.
- To correct a mistake you have just entered: press **Pause/Cancel** once, then re-enter the instructions.

OPERATION

Using the Instant Cook Buttons

- 1** Press the **Instant Cook** button corresponding to the food you are cooking (**Popcorn**, for example). The display shows the first serving size:

REGULAR 3.5 OZ

- 2** Press the button repeatedly to select the serving size you want. The display will cycle through all available serving sizes. Select the correct serving size.

LIGHT REGULAR 3.0-3.5 OZ

SNACK 1.75 OZ

LIGHT SNACK 1.5-1.75 OZ

- 3** Press the Start button to begin cooking.

*If you don't need to read all the MENU options, simply press the **Start** button to begin cooking.*

Instant Cook Chart

Item	Weight	Remarks
Popcorn	3.5 oz 3.0-3.5 oz 1.75 oz 1.5-1.75 oz	<ul style="list-style-type: none"> Use one microwave-only bag of popcorn. Use caution when removing and opening hot bag from oven.
Potato	1 EA 2 EA 3 EA 4 EA 5 EA 6 EA	<ul style="list-style-type: none"> Prick each potato several times with fork. Place on turntable in spoke-like fashion. Remove from oven, wrap in foil and let stand 3-5 min. One potato should be turn the food over at half time.
Fresh Vegetable	1 cup 2 cups 3 cups 4 cups	<ul style="list-style-type: none"> Place the vegetables into a casserole and add a small amount of water(2-4 Tbsp). Cover during cooking and stir before standing.
Frozen Dinner	7-10 oz 10-12 oz 12-18 oz	<ul style="list-style-type: none"> Remove package from outer wrapping and follow package instructions for covering and standing. After cooking, let stand 1-3 min.
Diet Cook (Low Calorie Frozen Dinner)	7-10 oz 10-12 oz	
Frozen Breakfast	2-4 oz 4-6 oz 6-8 oz	<ul style="list-style-type: none"> Remove package from outer wrapping and follow package instructions for covering and standing. After cooking, let stand 1-3 min.
Beverage	0.5 cup 1 cup 2 cups	<ul style="list-style-type: none"> Use a microwave-safe mug of room temperature coffee, tea, instant soup, etc. Stir before serving

Using the One Minute+

This button offers a convenient way to heat food in one-minute increments at the High power level.

- 1 Press the **One Minute+** button once for each minute you wish to cook the food. The time will display.
- 2 Press the **Start** button to begin cooking.

*Add minutes to a program in progress by pressing the **One Minute+** button for each minute you want to add.*

Reheating Automatically

To reheat food, select the type of dish and the number of servings you want to reheat, and the microwave automatically sets the reheating time.

- 1 Press the **Auto Reheat** button repeatedly to select the type of dish you wish to reheat. The initial serving size for each dish is one serving.



Plate of food



Casserole



Soup /Sauce

You can select up to four servings for casseroles and soup. Only one serving is available for a plate of food

The display shows the dish and quantity you have chosen, then "PRESS START."

- 2 Use the number buttons to increase the serving size. *For example, for three servings, press the "3" button (Refer to the Auto Reheat Chart below for the servings).* The display shows the number of servings you have selected:



- 3 Press the **Start** button. The display will show "REHEAT."

Auto Reheat Chart

Item	Weight	Remarks
Plate of Food	1 serving	<ul style="list-style-type: none"> • Cover plate with vented plastic wrap or wax paper • Contents <ul style="list-style-type: none"> - 3-4 oz. meat, poultry or fish (up to 6 oz. with bone) - 1/2 cup starch (potatoes, pasta, rice, etc.) - 1/2 cup vegetables (about 3-4 oz.)
Casserole	1 to 4 servings (8 oz./serving)	<ul style="list-style-type: none"> • Cover with lid or vented plastic wrap.
Soup/ Sauce	1 to 4 servings (8 oz./serving)	<ul style="list-style-type: none"> • Stir foods once before serving.

Defrosting Automatically

To thaw frozen food, set the weight of the food and the microwave automatically sets the defrosting time, power level and standing time.

- 1 Press the **Auto Defrost** button. The display shows "0.5 LB." (0.2Kg if you have set your oven for metric measure)



- 2 To set the weight of your food, press the **Auto Defrost** button repeatedly. This increases the weight by 0.5 lb increments, up to 6.0 lbs (The Auto Defrost button will increase the weight by 0.2Kg if you are using metric measurement).

You can also use the number buttons to enter the weight of the food directly.

- 3 Press the **Start** button to begin cooking.

The oven calculates the defrosting time. Twice during defrosting, the oven will beep and the display will read "TURN THE FOOD OVER."



- 4 Press the **Pause/Cancel** button, open the oven door, and turn the food over.
- 5 Press the **Start** button to resume defrosting.

• **See page 19 for the Auto Defrosting Guide**

Setting and Using the Custom Cook Button

The **Custom Cook** button memorizes the time and power setting for a particular food.

Programming the Custom Cook button

- 1 Press the **Custom Cook** button. Press the button twice to delete the previous Custom setting. The display shows "ENTER COOKING TIME AND POWER."



- 2 Use the **Number** buttons to enter the amount of cooking time. The display will show the amount of time you have set.

- 3 Press **Power Level** and use the **Number** buttons to enter the power level. The display will show the power level you have set. You can set the power level from 0 to 9.

1 = warm	2 = low
3 = defrost	4 = medium low
5 = medium	6 = simmer
7 = medium high	8 = reheat
9 = sauté	0 = high

- 4 Press the **Custom Cook** button again. The display will read "CUSTOM RECIPE SAVED."

Using the Custom Cook button

Press the **Custom** button after memorizing a recipe, then press **Start** button.

You can check the power level while cooking is in progress by pressing the **Power Level** button.

Adjusting the Volume

The **Sound** button on the microwave allows you to adjust the volume of the microwave's chime sound. The sound is initially set to its highest setting. To change the volume:

- 1 Press the **Sound** button. The display shows
"0-OFF 1-LOW 2-MED 3-HIGH"



- 2 Press "0" to turn the volume off, "1" for low volume, "2" for medium volume, or "3" for high volume.
The display will show the volume you have chosen, then shows "PRESS START"



- 3 Press **Start** :
The display returns to the time of day.

Using the Help system

Your microwave offers helpful instructions for many procedures.

- 1 When you need feature information and helpful hints, press the **Ayuda(Help Screen)** button and then press the button that you want to get information on. Help information is available in 4 languages (English, French, Spanish and Portuguese). The "HELP" indicator appears in the display while you are using this feature.

Setting Cooking Times & Power Levels

Your microwave allows you to set up to three different stages of cooking, each with its own time length and power level. The power level lets you control the heating intensity from Warm (1) to High (0).

One-stage Cooking

For simple one-stage cooking, you only need to set a cooking time. The power level is automatically set at High. If you want to set the power to any other level, you must set it using the **Power Level** button.

- 1 Use the number buttons to set a cooking time. You can set a time from one second to 99 minutes, 99 seconds. To set a time over one minute, enter the seconds too.
For example, to set 20 minutes, enter 2, 0, 0, 0.
- 2 If you want to set the power level to something other than High, press the **Power Level** button, then use the number buttons to enter a power level.

Power Levels:

1 = warm	6 = simmer
2 = low	7 = medium high
3 = defrost	8 = reheat
4 = medium low	9 = sauté
5 = medium	0 = high

The display shows "PRESS START OR ENTER NEXT STAGE COOKING TIME"



- 3 Press the **Start** button to begin cooking. If you want to change the power level, press **Pause/Cancel** before you press **Start**, and re-enter all of the instructions.

Setting Cooking Times, continued

Some recipes require different stages of cooking at different temperatures. You can set multiple stages of cooking with your microwave.

Multi-stage Cooking

- 1 Follow steps 1 and 2 in the "One-Stage Cooking" section on 12 page. The display shows "PRESS START OR ENTER NEXT STAGE COOKING TIME."



*When entering more than one cooking stage, the **Power Level** button must be pressed before the second cooking stage can be entered.*

*To set the power level at High for a stage of cooking, press the **Power Level** button twice.*

- 2 Use the number buttons to set a second cooking time.
- 3 Press the **Power Level** button, then use the number buttons to set the power level of the second stage of cooking. The display shows the power level you have set and then "PRESS START OR ENTER NEXT STAGE COOKING TIME."



- 4 Press **Start** to begin cooking, or repeat steps 2 and 3 to set a cooking time and power level for a third stage of cooking. When finished, press **Start**.

Using the More/Less Button

The **More/Less** button allows you to adjust pre-set cooking times. It only works with **Auto Reheat** and the **Instant Cook** buttons. Use the **More/Less** button only after you have already begun cooking with one of these procedures.

- 1 To ADD more time to an automatic cooking procedure: Press the **More/Less** button once. The word "MORE" will appear in the display.



- 2 To REDUCE the time of an automatic cooking procedure: Press the **More/Less** button twice. The word "LESS" will appear in the display.



- 3 To return to the NORMAL time set for an automatic cooking procedure: Press the **More/Less** button until the word "NORMAL" appears in the display.



Using the Kitchen Timer

- 1 Use the **Number** buttons to set the length of time you want the timer to run.
- 2 Press the **Kitchen Timer** button.
- 3 The display counts down and beeps when the time has elapsed.

Setting the Child Protection Lock

You can lock your microwave oven so it can't be used by unsupervised children.

- 1 Press the "0" button. The display shows "PRESS 1-DEMO 2-CHILD LOCK."



- 2 Press the "2" button. The display shows "PRESS START."

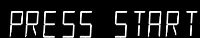

- 3 Press the **Start** button. The display shows "LOCK" then returns to the time of day.



At this point, the microwave oven cannot be used until it is unlocked. To unlock it, repeat steps 1–3 above.

Demonstration Mode

You can use the Demonstration Mode to see how your microwave oven operates without the oven heating.

- 1 Press the "0" button. The display shows "PRESS 1-DEMO 2-CHILD LOCK."



- 2 Press the "1" button. The display shows "PRESS START."

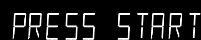

- 3 Press the **Start** button. The display shows "DEMO MODE ON" then "DEMO".



To turn demo mode off, repeat steps 1–3 above.

Using the Vent Fan

The vent fan removes steam and other vapors from surface cooking on your regular oven.

Press "**Fan on/off**" once for high fan speed, twice to turn the fan off.

Automatic Fan

An automatic fan feature protects the microwave from too much heat rising from the cooktop below it. If you have turned the fan on you may find that you cannot turn it off. The fan will automatically turn off when the internal parts are cool. It may stay on for 30 minutes or more after the cooktop and microwave controls are turned off.

Using the Cooktop Light

Press "**Light on/off**" to turn the cooktop light on or off.

COOKING INSTRUCTIONS

Cooking Utensils

This section lists which utensils can be used in the microwave, which ones have limited use for short periods, and which ones should not be used in the microwave.

Recommended Use

- **Glass and glass-ceramic bowls and dishes** — Use for heating or cooking.
- **Microwave browning dish** — Use to brown the exterior of small items such as steaks, chops, or pancakes. Follow the directions provided with your browning dish.
- **Microwavable plastic wrap** — Use to retain steam. Leave a small opening for some steam to escape and avoid placing it directly on the food.
- **Wax paper** — Use as a cover to prevent spattering.
- **Paper towels and napkins** — Use for short-term heating and covering; they absorb excess moisture and prevent spattering. Do not use recycled paper towels, which may contain metal and can catch fire.
- **Paper plates and cups** — Use for short-term heating at low temperatures. Do not use recycled paper, which may contain metal and can catch fire.
- **Thermometers** — Use only those labeled “Microwave Safe” and follow all directions. Check the food in several places. Conventional thermometers may be used once the food has been removed from the oven.

Limited Use

- **Aluminum foil** — Use narrow strips of foil to prevent overcooking of exposed areas. Using too much foil can damage your oven, so be careful.
- **Ceramic, porcelain, and stoneware** — Use these if they are labeled “Microwave Safe.” If they are not labeled, test them to make sure they can be used safely. Never use dishes with metallic trim.
- **Plastic** — Use only if labeled “Microwave Safe.” Other plastics can melt.
- **Straw, wicker, and wood** — Use only for short-term heating, as they can be flammable.

Not Recommended

- **Glass jars and bottles** — Regular glass is too thin to be used in a microwave, and can shatter.
- **Paper bags** — These are a fire hazard, except for popcorn bags that are designed for microwave use.
- **Styrofoam plates and cups** — These can melt and leave an unhealthy residue on food.
- **Plastic storage and food containers** — Containers such as margarine tubs can melt in the microwave.
- **Metal utensils** — These can damage your oven. Remove all metal before cooking.

Testing Utensils

If you are not sure whether a dish is microwave-safe or not, you can perform this test:

- 1 Fill a 1 cup glass measuring cup with water and put it inside your oven, next to the dish you want to test.

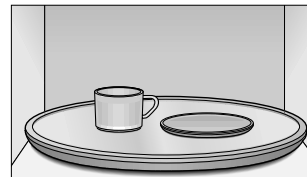

- 2 Press the **One Minute+** button once to heat them for one minute at High power. Press the **Start** button.

The water should be warm and the dish you are testing should be cool. If the dish is warm, then it is absorbing microwave energy and is not acceptable for use in the microwave.

Cooking Techniques

Your microwave makes cooking easier than conventional cooking, provided you keep these considerations in mind:

Stirring

Stir foods such as casseroles and vegetables while cooking to distribute heat evenly. Food at the outside of the dish absorbs more energy and heats more quickly, so stir from the outside to the center. The oven will turn off when you open the door to stir your food.

Arrangement

Arrange unevenly shaped foods, such as chicken pieces or chops, with the thicker, meatier parts toward the outside of the turntable where they receive more microwave energy. To prevent overcooking, place thin or delicate parts toward the center of the turntable.

Shielding

Shield food with narrow strips of aluminum foil to prevent overcooking. Areas that need shielding include poultry wing-tips, the ends of poultry legs, and corners of square baking dishes. Use only small amounts of aluminum foil. Larger amounts can damage your oven.

Turning

Turn foods over midway through cooking to expose all parts to microwave energy. This is especially important with large items such as roasts.

Standing

Foods cooked in the microwave build up internal heat and continue to cook for a few minutes after the oven stops. Let foods stand to complete cooking, especially foods such as roasts and whole vegetables. Roasts need this time to complete cooking in the center without overcooking the outer areas. All liquids, such as soup or hot chocolate, should be shaken or stirred when cooking is complete. Let liquids stand a moment before serving. When heating baby food, stir well and test the temperature before serving.

Adding Moisture

Microwave energy is attracted to water molecules. Food that is uneven in moisture content should be covered or allowed to stand so that the heat disperses evenly. Add a small amount of water to dry food to help it cook.

General Tips

- Dense foods, such as potatoes, take longer to heat than lighter foods. Foods with a delicate texture should be heated at a low power level to avoid becoming tough.
- Altitude and the type of cookware you are using can affect cooking time. When using a new recipe, use the minimum cooking time and check the food occasionally to prevent overcooking.
- Foods with a non-porous skin or shell, such as potatoes, eggs, or hot dogs, should be pierced to prevent bursting.
- Frying with heating oil or fat is not recommended. Fat and oil can suddenly boil over and cause severe burns.
- Some ingredients heat faster than others. For example, the jelly inside a jelly doughnut will be hotter than the dough. Keep this in mind to avoid burns.
- Home canning in the microwave oven is not recommended because all harmful bacteria may not be destroyed by the microwave heating process.
- Although microwaves do not heat the cookware, the heat is often transferred to the cookware. Always use pot holders when removing food from the microwave and instruct children to do the same.

COOKING INSTRUCTIONS

GUIDE for Cooking Meat in Your Microwave

- Place meat on a microwave-safe roasting rack in a microwave-safe dish.
- Start meat fat-side down. Use narrow strips of aluminum foil to shield any bone tips or thin meat areas.
- Check the temperature in several places before letting the meat stand the recommended time.
- The following temperatures are removal temperatures. The temperature of the food will rise during the standing time.

Food	Cook Time /Power Level	Directions
Roast Beef Boneless Up to 4 lbs.	<i>Cooking Time:</i> 7-10 min. / lb. for 115° F - Rare 8-12 min. / lb. for 120° F - Medium 9-14 min. / lb. for 145° F - Well Done <i>Power Level:</i> High(10) for first 5 min., then Medium(5).	Place roast fat-side down on roasting rack. Cover with wax paper. Turn over when cooking time is half up. Let stand 10 min.
Pork Boneless or bone-in Up to 4 lbs.	<i>Cooking Time:</i> 10-14 min. / lb. for 160° F Well Done <i>Power Level:</i> High(10) for first 5 min., then Medium(5).	Place roast fat-side down on roasting rack. Cover with vented plastic wrap. Turn over when cooking time is half up. Let stand 10 min.
Bacon 2-6 slices	<i>Cooking Time:</i> 2 slices: 11/2-2 min. 4 slices: 21/2- 31/2 min. 6 slices: 6-71/2 min. <i>Power Level:</i> High(10).	Arrange slices on roasting rack or a dish lined with paper-towel. Cover with paper towel. Microwave until crisp.

GUIDE for Cooking Poultry in Your Microwave

- Place poultry on a microwave-safe roasting rack in a microwave-safe dish.
- Cover poultry with wax paper to prevent spattering.
- Use aluminum foil to shield bone tips, thin meat areas, or areas that start to overcook.
- Check the temperature in several places before letting the poultry stand the recommended time.

Food	Cook Time /Power Level	Directions
Whole Chicken Up to 4 lbs.	<i>Cooking Time:</i> 6-9 min. / lb. 170° -180°F <i>Power Level:</i> Medium High(7).	Place chicken breast-side down on roasting rack. Cover with wax paper. Turn over when the cooking time is half up. Cook until juices run clear and meat near the bone is no longer pink. Let stand 5-10 min.
Chicken Pieces Up to 2 lbs.	<i>Cooking Time:</i> 6-9 min. / lb. 180°F dark meat 170°F light meat <i>Power Level:</i> Medium High(7).	Place chicken bone-side down on dish, with the thickest portions towards the outside of the dish. Cover with wax paper. Turn over when the cooking time is half up. Cook until juices run clear and meat near the bone is no longer pink. Let stand 5-10 min.

GUIDE for Cooking Seafood in Your Microwave

- Cook fish until it flakes easily with a fork.
- Place fish on a microwave-safe roasting rack in a microwave-safe dish.
- Use a tight cover to steam fish. A lighter cover of wax paper or paper towel provides less steaming.
- Do not overcook fish; check it at minimum cooking time.

Food	Cook Time /Power Level	Directions
Steaks Up to 1.5 lbs.	<i>Cooking Time:</i> 7-11 min. / lb. <i>Power Level:</i> Medium High(7).	Arrange steaks on roasting rack with meaty portions towards the outside of rack. Cover with wax paper. Turn over and rearrange when cooking time is half up. Cook until fish flakes easily with a fork. Let stand 3-5 min.
Filletts Up to 1.5 lbs.	<i>Cooking Time:</i> 3-7 min. / lb. <i>Power Level:</i> Medium High(7).	Arrange fillets in a baking dish, turning any thin pieces under. Cover with wax paper. If over 1/2 inch thick, turn over and rearrange when cooking time is half up. Cook until fish flakes easily with a fork. Let stand 2-3 min.
Shrimp Up to 1.5 lbs.	<i>Cooking Time:</i> 3-6 1/2min. / lb. <i>Power Level:</i> Medium High(7).	Arrange shrimp in a baking dish without overlapping or layering. Cover with wax paper. Cook until firm and opaque, stirring 2 or 3 times. Let stand 5 min.

GUIDE for Cooking Eggs in Your Microwave

- Never cook eggs in the shell, and never warm hard-cooked eggs in the shell; they can explode.
- Always pierce whole eggs to keep them from bursting.
- Cook eggs just until set; they become tough if overcooked.

GUIDE for Cooking Vegetables in Your Microwave

- Vegetables should be washed just before cooking. Often, no extra water is needed. If dense vegetables such as potatoes, carrots and green beans are being cooked, add about 1/4 cup water.
- Small vegetables (sliced carrots, peas, lima beans, etc.) will cook faster than larger ones.
- Whole vegetables, such as potatoes, acorn squash or corn on the cob, should be arranged in a circle on the turntable before cooking. They will cook more evenly if turned over after half the cooking time.
- Always place vegetables like asparagus and broccoli with the stem ends pointing towards the edge of the dish and the tips toward the center.
- When cooking cut vegetables, always cover the dish with a lid or vented microwavable plastic wrap.
- Whole, unpeeled vegetables such as potatoes, squash, eggplant, etc., should have their skin pricked in several spots before cooking to prevent them from bursting.
- For more even cooking, stir or rearrange whole vegetables halfway through the cooking time.
- Generally, the denser the food, the longer the standing time. (Standing time refers to the time necessary for dense, large foods and vegetables to finish cooking after they come out of the oven.) A baked potato can stand on the counter for five minutes before cooking is completed, while a dish of peas can be served immediately.

AUTO DEFROSTING GUIDE

- Follow the instructions below when defrosting different types of food.

Food	Amount	Procedure
Roast Beef, Pork	<i>2.5-6.0 lbs.</i>	Start with the food placed fat side down. After each stage, turn the food over and shield any warm portions with narrow strips of aluminum foil.
Steaks, Chops, Fish	<i>0.5-3.0 lbs.</i>	After each stage, rearrange the food. If there are any warm or thawed portions of food, shield them with narrow flat pieces of aluminum foil. Remove any pieces of food that are nearly defrosted. Let stand, covered, for 5-10 minutes.
Ground Meat	<i>0.5-3.0 lbs.</i>	After each stage, remove any pieces of food that are nearly defrosted. Let stand, covered with foil, for 5–10 minutes.
Whole Chicken	<i>2.5-6.0 lbs.</i>	Remove giblets before freezing poultry. Start defrosting with the breast side down. After the first stage, turn the chicken over and shield any warm portions with narrow strips of aluminum foil. After the second stage, again shield any warm portions with narrow strips of aluminum foil. Let stand, covered, for 30–60 minutes in the refrigerator.
Chicken Pieces	<i>0.5-2.0 lbs.</i>	After each stage, rearrange or remove any pieces of food that are nearly defrosted. Let stand for 10-20 minutes.

Notes

Check foods when the oven signals. After the final stage, small sections may still be icy; let them stand to continue thawing. Do not defrost until all ice crystals have thawed.

Shielding roasts and steaks with small pieces of foil prevents the edges from cooking before the center of the food has defrosted. Use narrow, flat, smooth strips of aluminum foil to cover the edges and thinner sections of the food.

Recipes

Beef and Barley Stew

1 1/2 lbs. beef stew cubes, cut into 1/2-inch pieces
 1/2 cup chopped onion
 2 Tbs. all-purpose flour
 1 Tbs Worcestershire sauce
 1 can (13.75-14.5 oz.) beef broth
 2 medium carrots, cut into 1/2-inch slices (about 1 cup)
 1/2 cup barley
 1 bay leaf
 1/4 tsp. pepper
 1 pkg. (9-10 oz.) frozen peas, thawed

1. In a 2-quart casserole, combine beef, onion, flour, and Worcestershire; mix well. Cover with lid. Cook at High for 6 to 8 minutes until beef is no longer pink, stirring once.
2. Stir in beef broth, carrots, barley, bay leaf, and pepper. Cover with lid. Cook at Medium for 50 to 60 minutes until carrots and beef are tender, stirring 2 to 3 times.
3. Stir in peas. Cover with lid. Cook at Medium for 10 minutes. Let stand for 10 minutes. Remove bay leaf before serving.

Broccoli and Cheese Casserole

1/4 cup butter or margarine
 1/4 cup chopped onion
 1 1/2 Tbs. flour
 1/2 tsp. salt
 1/4 tsp. dry mustard
 1/8 tsp. pepper
 1 1/2 cups milk
 1/4 cup chopped red pepper
 8 oz. (2 cups) cheddar cheese, shredded
 1 pkg. (9-10 oz.) frozen chopped broccoli, thawed
 4 cups cooked spiral shaped pasta (8 oz. dry)

1. In a 2-quart casserole, cook butter and onion at High for 2 to 3 minutes until onion is soft, stirring once.
2. Add flour, salt, mustard, and pepper; mix well. Cook at High for 60 to 90 seconds until mixture boils. Stir in milk until smooth.
3. Stir in red pepper. Cook at High for 2 to 3 minutes until mixture boils and thickens slightly, stirring twice. Stir in cheese until melted.
4. Add broccoli and pasta, mix well. Cover with lid. Cook at High for 4 to 6 minutes until heated through, stirring once. Stir before serving. .

Recipes

Warm Potato Salad

2 lbs. small red potatoes, cut into 1/2-inch pieces
 4 slices bacon (uncooked), cut into 1/2-inch pieces
 1/4 cup chopped onion
 2 tsp. sugar
 1 tsp. salt
 1 tsp. flour
 1/2 tsp. celery seed
 1/8 tsp. pepper
 2 1/2 Tbs. apple cider vinegar

1. In a 2-quart casserole, combine potatoes and 1/4 cup water. Cover with lid. Cook at High until potatoes are tender (10-12 min.); stir twice. Drain and set aside to cool slightly.
2. In a medium bowl, cook bacon at High until crisp (2 1/2-4 min.); stir once. Place bacon on a paper towel. Reserve 1 Tbs. drippings.
3. Combine drippings and onion. Cover with plastic wrap; turn back a corner to vent steam. Cook at High until tender (2-3 min.); stir once.
4. Stir in sugar, salt, flour, celery seed, and pepper. Cook at High until mixture boils (30-40 sec.). Stir in vinegar and 1/2 cup water. Cook at High until liquid boils and thickens slightly (1-2 min.); stir once. Add bacon to dressing. Pour dressing over potatoes. Stir well.

Black Bean Soup

1 cup chopped onion
 1 clove garlic, minced
 2 cans (15 oz. each) black beans, drained
 1 can (14-16 oz.) stewed tomatoes, chopped
 1 can (13.75-14.5 oz.) chicken broth
 1 can (7-8.5 oz.) corn
 1 can (4 oz.) chopped green chilies
 2 tsp. ground cumin, or to taste

1. Place onion and garlic in a 3-quart casserole. Cover with lid. Cook at High for 3 to 5 minutes until tender.
2. Add one can of beans, mash beans with a fork. Add remaining ingredients; mix well.
3. Cook uncovered, at High for 10 minutes; stir. Reduce power to Medium and cook for 5 minutes. Stir before serving. .

Troubleshooting Guide

Before you call a repair person for your oven, check this list of possible problems and solutions.

Neither the oven's display nor the oven operate.

- Properly insert the plug into a grounded outlet.
- If the outlet is controlled by a wall switch, make sure the wall switch is turned on.
- Remove the plug from the outlet, wait ten seconds, then plug it in again.
- Reset the circuit breaker or replace any blown fuse.
- Plug another appliance into the outlet; if the other appliance doesn't work, have a qualified electrician repair the outlet.
- Plug the oven into a different outlet.

The oven's display works, but the power won't come on.

- Make sure the door is closed securely.
- Check to see if packing material or other material is stuck to the door seal.
- Check for door damage.
- Press Cancel twice and re-enter all cooking instructions.

The power goes off before the set time has elapsed.

- If there has not been a power outage, remove the plug from the outlet, wait ten seconds, then plug it in again. If there was a power outage, the time indicator will display "SAMSUNG SO SIMPLE" Reset the clock and any cooking instructions.
- Reset the circuit breaker or replace any blown fuse.

The food is cooking too slowly.

- Make sure the oven is on its own 20 amp circuit line. Operating another appliance on the same circuit can cause a voltage drop. If necessary, move the oven to its own circuit.

You see sparks or arcing.

- Remove any metallic utensils, cookware, or metal ties. If using foil, use only narrow strips and allow at least one inch between the foil and interior oven walls.

The turntable makes noises or sticks.

- Clean the turntable, roller ring and oven floor.
- Make sure the turntable and roller ring are positioned correctly.

Using your microwave causes TV or radio interference.

- This is similar to the interference caused by other small appliances, such as hair dryers. Move your microwave further away from other appliances, like your TV or radio.

Care and Cleaning

Follow these instructions to clean and care for your oven.

- Keep the inside of the oven clean. Food particles and spilled liquids can stick to the oven walls, causing the oven to work less efficiently.
- Wipe up spills immediately. Use a damp cloth and mild soap. Do not use harsh detergents or abrasives.
- To help loosen baked on food particles or liquids, heat two cups of water (add the juice of one lemon if you desire to keep the oven fresh) in a four-cup measuring glass at High power for five minutes or until boiling. Let stand in the oven for one or two minutes.
- Remove the glass tray from the oven when cleaning the oven or tray. To prevent the tray from breaking, handle it carefully and do not put it in water immediately after cooking. Wash the tray carefully in warm sudsy water or in the dishwasher.
- Clean the outside surface of the oven with soap and a damp cloth. Dry with a soft cloth. To prevent damage to the operating parts of the oven, don't let water seep into the openings.
- Wash the door window with very mild soap and water. Be sure to use a soft cloth to avoid scratching.
- If steam accumulates inside or outside the oven door, wipe with a soft cloth. Steam can accumulate when operating the oven in high humidity and in no way indicates microwave leakage.
- Never operate the oven without food in it; this can damage the magnetron tube or glass tray. You may wish to leave a cup of water in the oven when it is not in use to prevent damage if the oven is accidentally turned on.

How to Clean the Outside

Do not use cleaners containing ammonia or alcohol on the microwave oven. Ammonia or alcohol can damage the appearance of the microwave.

Case

Clean the outside of the microwave with a sudsy cloth. Rinse and then dry. Wipe the window clean with a damp cloth.

Control Panel and Door

Wipe with a damp cloth. Dry thoroughly. Do not use cleaning sprays, large amounts of soap and water, abrasives or sharp objects on the panel—they can damage it. Some paper towels can also scratch the control panel.

Door Surface

It's important to keep the area clean where the door seals against the microwave. Use only mild, nonabrasive detergents applied with a clean sponge or soft cloth. Rinse well.

Bottom

Clean off the grease and dust on the bottom often. Use a solution of warm water and detergent.

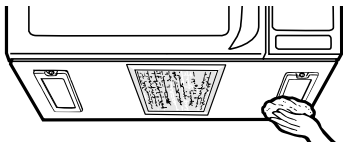

Light Bulb Replacement

Cooktop Light

Replace the burned-out bulb with a 40-watt incandescent bulb.

1. To replace the bulb(s), first disconnect the power at the main fuse or circuit breaker panel or pull the plug.
2. Remove the screw at the front of the light cover and lower the cover.

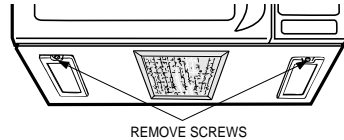

3. Be sure the bulb(s) to be replaced are cool before removing. After breaking the adhesive seal, remove the bulb by gently turning. Put in new bulb.
4. Replace the light cover and screw. Connect electrical power to the oven.

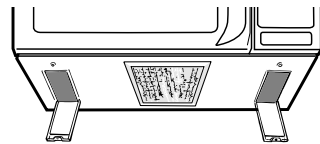

Oven Light

Replace the burned-out bulb with a 40-watt incandescent bulb.

1. To replace the oven light, first disconnect the power at the main fuse or circuit breaker panel or pull the plug.
2. Remove the top grille by taking out the 2 screws that hold it in place.
3. Next, remove the screw located above the door near the center of the oven that secures the light housing. Remove the housing and bulb.
4. Insert new bulb. Replace the light housing and screw.
5. Replace the top grille and 2 screws, Connect electrical power to the oven.

Exhaust Feature

The Vent Fan

The exhaust fan has 1 metal reusable grease filter.

A charcoal filter can be used for removing smoke and odors in case of recirculating air back into the room.

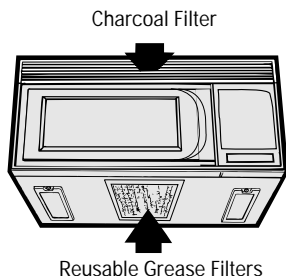

Reusable Grease Filters

The metal filter trap grease released by foods on the cooktop. They also prevent flames from foods on the cooktop from damaging the inside of the microwave.

For this reason, the filters must ALWAYS be in place when the hood the vent fan is used. The grease filter should be cleaned once a month, or as needed.

Removing and Cleaning the Filter

To remove, slide it to the left using the tab. Pull it down and out.

To clean the grease filter, soak it and then swish it around in hot water and detergent. Don't use ammonia or ammonia products because they will darken the metal.

Light brushing can be used to remove embedded dirt.

Rinse, shake and let it dry before replacing.

To replace, slide the filter in the frame slot on the left of the opening. Pull up and to the right to lock into place.

Charcoal Filter

The charcoal filter cannot be cleaned.

It must be replaced.

Order part No. DE74-00020A from your appliance dealer.

If the oven is installed on the wall (or cabinet) not vented to the outside, the air will be recirculated through a disposable charcoal filter that helps remove smoke and odors.

The charcoal filter should be replaced when it is noticeably dirty or discolored (usually after 6 to 12 months, depending on hood usage).

Removing Charcoal Filter

To remove the charcoal filter, disconnect power at the main fuse or circuit breaker panel or pull the plug. Remove the top grille by removing the 2 screws that hold it in place.

Slide the filter towards the front of the oven and remove it.

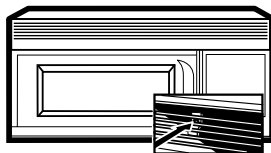

Remove 2 grille screws to remove the grille.

Installing Charcoal Filter

To install a new filter, remove plastic and other outer wrapping from the new filter.

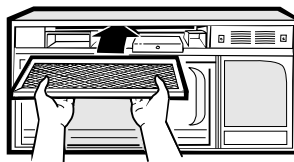

Insert the filter into the top opening of the oven as shown. It will rest at an angle on 2 side support tabs and in front of the right rear tab. Replace the grille and 2 screws.

**If you have a problem you cannot solve,
please call our service line:
1-800-SAMSUNG**

Warranty Information

Limited Warranty for Original Purchaser

This Samsung product is warranted by Samsung Electronics America, Inc. (hereafter referred to as SEA) against manufacturing defects in material or workmanship for the following periods:

Labor: One year (in Home)
 Parts: One year
 Magnetron: Eight years

SEA further warrants that if this product fails to operate properly within the specified warranty period and the failure is due to improper workmanship or defective material, SEA will repair or replace the product at its option.

All warranty repairs or part replacements must be performed by a SEA Authorized Service Center. (To find the nearest SEA Service Center, call 1-800-SAMSUNG.)

Obligation to the Original Owner

The original dated sales receipt must be retained by the customer and is the only acceptable proof of purchase. It must be presented to an SEA

Authorized Service Center at the time service is requested before warranty services are rendered. On all carry-in models, transportation to and from the Authorized Service Center is the responsibility of the customer.

Exclusions of the Warranty

This warranty does not cover damage due to accident, fire, flood, and/or other Acts of God: misuse, incorrect line voltage, improper installation, improper or unauthorized repairs, commercial use, or damage that occurs during shipping. Customer adjustments which are explained in this owner's manual are not covered under the terms of this warranty. This warranty will automatically be voided for any unit found with a missing or altered serial number. This warranty is valid only on products purchased and used in the United States and Puerto Rico. Some states do not allow the exclusion or limitations of incidental or consequential damages, or allow limitations on how long an implied warranty lasts, so the above limitations or exclusions may not apply to you. This warranty gives you specific legal rights and you may also have other rights which vary from state to state.

Specifications

Model Number	SRH1230ZG / SRH1230ZW / SRH1230ZS
Oven Cavity	1.2cu-ft
Controls	10 power levels, including defrost
Timer	99 minutes, 99 seconds
Power Source	120 VAC, 60 Hz
Power Consumption	1500 Watts
Power Output	900 Watts
Oven Cavity Dimensions	14 ³ / ₄ " (W)X9 ¹ / ₁₆ " (H)X15 ⁷ / ₁₆ " (D)
Outside Dimensions	23 ³ / ₈ " (W)X15 ¹⁵ / ₃₂ " (16 ¹¹ / ₁₆ " (H)X16 ² / ₃₂ " (D)
Shipping Dimensions	26 ⁹ / ₁₆ " (W)X21 ¹ / ₁₆ " (H)X19 ³ / ₃₂ " (D)
Net/Gross Weight	54.0/58.4 lbs

SAMSUNG ELECTRONICS

NORTH AMERICAN LIMITED WARRANTY STATEMENT

Subject to the requirements, conditions, exclusions and limitations of the Original Limited Warranty supplied with Samsung Electronics (SAMSUNG) products, and the requirements, conditions, exclusions and limitations contained herein, SAMSUNG will additionally provide Warranty Repair Service in the United States on SAMSUNG products purchased in Canada, and in Canada on SAMSUNG products purchased in the United States, for the warranty period originally specified, and to the Original Purchaser only.

The above described warranty repairs must be performed by a SAMSUNG Authorized Service Center. Along with this Statement, the Original Limited Warranty Statement and a dated Bill of Sale as Proof of Purchase must be presented to the Service Center. Transportation to and from the Service Center is the responsibility of the purchaser.

Conditions covered are limited only to manufacturing defects in material or workmanship, and only those encountered in normal use of the product.

Excluded, but not limited to, are any original specified provisions for, in-home or on-site services, minimum or maximum repair times, exchanges or replacements, accessories, options, upgrades, or consumables.

For the locations of a SAMSUNG Authorized Service Center, please call toll-free:

In the United States: 1-800-SAMSUNG (1-800-726-7864)
In Canada: 1-800-SAMSUNG

Función	Operación
Ajuste de Reloj	<ol style="list-style-type: none"> 1. Presione CLOCK. 2. Use botones numéricos para seleccionar hora. 3. Presiones CLOCK de nuevo.
Cocinado Fase simple	<ol style="list-style-type: none"> 1. Use botones numéricos para seleccionar tiempo. 2. Seleccione nivel de poder o deje alto. 3. Presione START.
Cocinado Un Minuto +	<ol style="list-style-type: none"> 1. Presione el botón ONE MINUTE+ por cada minuto de cocción. 2. Presione START.
Botones de Cocinado Instantáneo	<ol style="list-style-type: none"> 1. Presione botón que corresponde al alimento que esta cocinando. (Por ejemplo, palomitas.) 2. Presione el botón para seleccionar el tamaño de la porción. 3. Presione START.
Descongelado Automático	<ol style="list-style-type: none"> 1. Presione AUTO DEFROST. 2. Ingrese el peso del alimento presionando el botón de AUTO DEFROST repetidamente o con los botones numéricos. 3. Presione START. 4. Después de medio tiempo, presione CANCEL voltee el alimento, y presiones START para re iniciar.
Recalentado Automático	<ol style="list-style-type: none"> 1. Presione AUTO REHEAT repetidamente para seleccionar tipo de platillo. 2. Para incrementar tamaño de porción, presione los botones numéricos 3. Presione START para comenzar.
Ajuste de Niveles de Poder y Tiempo de Cocinado	<ol style="list-style-type: none"> 1. Use botones numéricos para tiempo de cocción. 2. Para seleccionar nivel de poder, presione los botones numéricos. 3. Presione START para empezar a cocinar.

QUICK REFERENCE(ENGLISH)

Feature	Operation
Set Clock	<ol style="list-style-type: none">1. Press CLOCK.2. Use number buttons to enter time.3. Press CLOCK again.
One Stage Cooking	<ol style="list-style-type: none">1. Use number buttons to set cooking time.2. Set power level or leave at high.3. Press START.
One Minute+ Cooking	<ol style="list-style-type: none">1. Press the ONE MINUTE + button once for each minute of cooking.2. Press START.
Instant Cook Buttons	<ol style="list-style-type: none">1. Press button that corresponds to the food you are cooking (for example, POPCORN).2. Press the button repeatedly to select serving size.3. Press START.
Auto Defrost	<ol style="list-style-type: none">1. Press AUTO DEFROST.2. Enter weight of food by pressing AUTO DEFROST button repeatedly or using the number buttons.3. Press START.4. When prompted by oven display, press PAUSE/CANCEL button and turn food over. Press START to resume defrosting cycle.
Auto Reheat	<ol style="list-style-type: none">1. Press AUTO REHEAT repeatedly to select type of dish to reheat.2. To increase serving size, press the corresponding number button.3. Press START to begin reheating cycle.
Set Cooking Time and Power Levels	<ol style="list-style-type: none">1. Use number buttons to set cooking time.2. To set power level at other than HIGH, press POWER LEVEL and use the number buttons to enter the power level.3. Press START to begin cooking.



ELECTRONICS

SAMSUNG ELECTRONICS AMERICA, INC.

HEADQUARTERS

105 CHALLENGER ROAD

RIDGEFIELD PARK, NEW JERSEY 07660-0511

1-800-SAMSUNG(1-800-726-7864)

WWW.SAMSUNGUSA.COM

Samsung Electronics Co., Ltd.

Printed in Korea

Free Manuals Download Website

<http://myh66.com>

<http://usermanuals.us>

<http://www.somanuals.com>

<http://www.4manuals.cc>

<http://www.manual-lib.com>

<http://www.404manual.com>

<http://www.luxmanual.com>

<http://aubethermostatmanual.com>

Golf course search by state

<http://golfingnear.com>

Email search by domain

<http://emailbydomain.com>

Auto manuals search

<http://auto.somanuals.com>

TV manuals search

<http://tv.somanuals.com>