

SAMSUNG

COLOR DUAL QUAD NETWORK OBSERVATION SYSTEM

SSC21WEB

User Guide

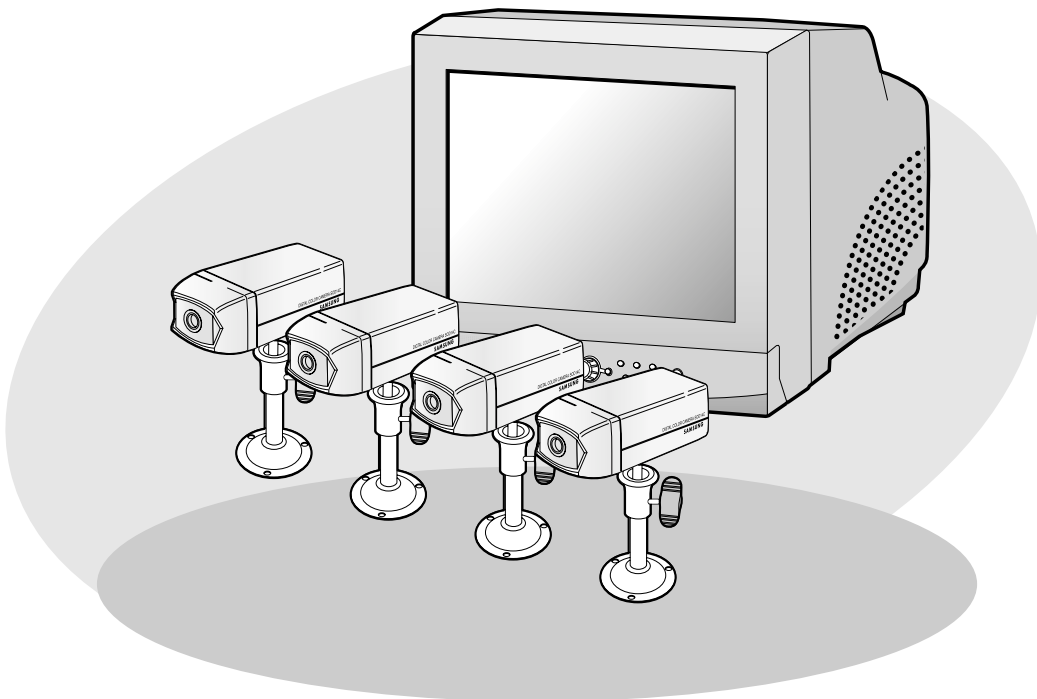

User Guide

IMPORTANT SAFETY INSTRUCTIONS

1. Read these instructions.
2. Keep these Instructions.
3. Heed all warnings.
4. Follow all instructions.
5. Do not use this apparatus near water.
6. Clean only with dry cloth.
7. Do not block any ventilation openings. Install in accordance with the manufacturer's instructions.
8. Do not install near any heat sources such as radiators, heat registers, stoves, or other apparatus (including amplifiers) that produce heat.
9. Do not defeat the safety purpose of the polarized or grounding-type plug. A polarized plug has two blades with one wider than the other. A grounding type plug has two blades and a third grounding prong. The wide blade or the third prong are provided for your safety. If the provided plug does not fit into your outlet consult an electrician for replacement of the obsolete outlet.
10. Protect the power cord from being walked on or pinched particularly at plugs convenience receptacles and the point where they exit from the apparatus.
11. Only use attachment/accessories specified by the manufacturer.
12. Use only with the cart, stand, tripod, bracket, or table specified by the manufacturer or sold with the apparatus. When a cart is used, use caution when moving the cart/apparatus combination to avoid injury from tip-over.
13. Unplug this apparatus during lightning storms or when unused for long periods of time.
14. Refer all servicing to qualified service personnel. Servicing is required when the apparatus has been damaged in any way such as power-supply cord or plug is damaged liquid has been spilled or objects have fallen into the apparatus the apparatus has been exposed to rain or moisture does not operate normally or has been dropped.



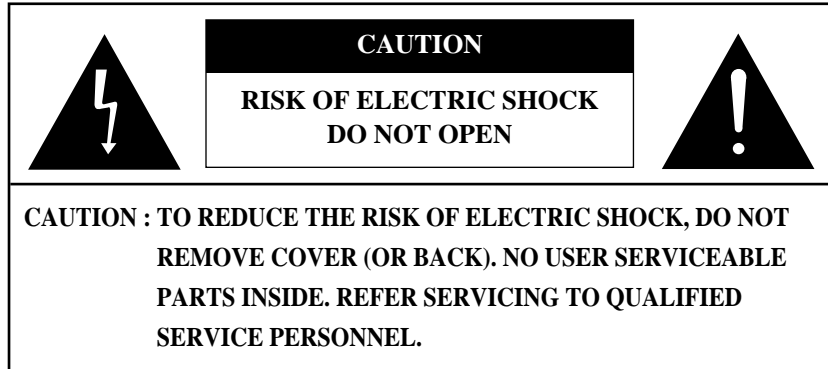
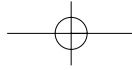

Graphic Symbol Explanation

The lightning flash with arrowhead symbol within an equilateral triangle is intended to alert the user to the presence of uninsulated 'dangerous voltage' within the product's enclosure that may be of sufficient magnitude to constitute a risk of electric shock to persons.

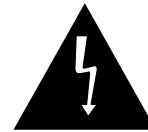

The exclamation point within an equilateral triangle is intended to alert the user to the presence of important operating and maintenance (servicing) instructions in the literature accompanying the appliance.



Warning - To Prevent Fire or Shock Hazard, Do Not Expose This Monitor To Rain or Moisture.

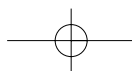

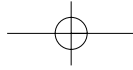

IMPORTANT SAFEGUARDS

Caution

Power source is indicated on the rear of the set. It contains high-voltage parts. If you remove the cover, it may cause fire or electric shock. Do not remove the cover by yourself. (Control switches are at the front of the monitor.)

- 1. Read Instructions :** All the safety and operating instructions should be read before the appliance is operated.
- 2. Retain Instructions :** The safety and operating instructions should be retained for future reference.
- 3. Heed Warnings :** All warnings on the monitor and in the operating instructions should be adhered to.
- 4. Follow Instructions :** All operating and user instructions should be followed.
- 5. Cleaning :** Unplug this monitor from the wall outlet before cleaning. Do not use liquid cleaners or aerosol cleaners. Use a damp cloth for cleaning.
Exception. A monitor that is meant for uninterrupted service and that for some specific reason such as the possibility of the loss of an authorization code for a CATV converter is not intended to be unplugged by the user for cleaning or any other purpose may exclude the reference to unplugging the monitor in the cleaning description otherwise required in Item 5.
- 6. Attachments :** Do not use attachments not recommended by Samsung as they may cause hazards.
- 7. Water and Moisture :** Do not use this monitor near water for example near a bathtub wash bowl kitchen sink or laundry tub in a wet basement or near a swimming pool and the like wet basement or near a swimming pool and the like.

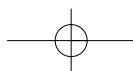

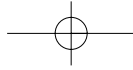

- 8. Accessories :** Do not place this monitor on an unstable cart, stand, tripod, bracket or table. The monitor may fall causing serious injury to a child or adult and serious damage to the appliance. Use only with a cart, stand, tripod, bracket or table recommended by Samsung or sold with the monitor. Any mounting of the monitor should follow Samsung's instructions and should use a mounting accessory recommended by Samsung.
- 9. Ventilation :** Slots and openings in the cabinet are provided for ventilation and to ensure reliable operation of the monitor and to protect it from overheating and these openings should never be blocked by placing the monitor on a bed, sofa, rug, or other similar surface. This monitor should never be placed near or over a radiator or heat register. This monitor should not be placed in a built-in installation such as a bookcase or rack unless proper ventilation is provided or Samsung's instructions have been adhered to.
- 10. Power Sources :** This monitor should be operated only from the type of power source indicated on the making label. If you are not sure of the type of power supply to your installation site consult your Samsung dealer or local power company.
- 11. Grounding or Polarization :** For monitors equipped with a 3-wire grounding-type plug having a third(grounding) pin. This plug will only fit into a grounding type power outlet. This is a safety feature. If you are unable to insert the plug into the outlet contact your electrician to replace your obsolete outlet. Do not defeat the safety purpose of the grounding-type plug.
- 12. Power :** Cord Protection-Power supply cords should be routed so that they are not likely to be walked on or pinched by items placed upon or against them paying particular attention to cords at plugs convenience receptacles and the point where they exit from the monitor.

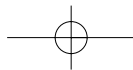

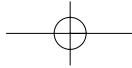

User Guide

- 13. Lightning :** For added protection for this monitor during a lightning storm or when it is left unattended and unused for long periods of time, unplug it from the wall outlet and disconnect the cable system. This will prevent damage to the monitor due to lightning and power-line surges.
- 14. Overloading :** Do not overload wall outlets and extension cords as this can result in a risk of fire or electric shock.
- 15. Object and liquid Entry :** Never push objects of any kind into this monitor through openings as they may touch dangerous voltage points or short-out parts that could result in a fire or electric shock.
Never spill liquid of any kind on the monitor.
- 16. Servicing :** Do not attempt to service this monitor yourself as opening or removing cover may expose you to dangerous voltage or other hazards. Refer all servicing to qualified service personnel.
- 17. Damage Requiring Service :** Unplug this monitor from the wall outlet and refer servicing to qualified service personnel under the following conditions.
- When the power-supply cord or plug is damaged.
 - If liquid has been spilled or objects have fallen into the monitor.
 - If the monitor has been exposed to rain or water.
 - If the monitor does not operate normally by following the operating instructions. Adjust only those controls that are covered by the operating instructions as an improper adjustment of other controls may result in damage and require extensive work by a qualified technician to restore the monitor to its normal operation.
 - If the monitor has been dropped or the cabinet has been damaged.
 - When the monitor exhibits a distinct change in performance-this indicates a need for service.

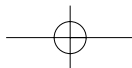

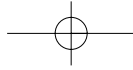

18. Replacement Parts : When replacement parts are required be sure the service technician has used replacement parts specified by Samsung or have the same characteristics as the original parts.

Unauthorized substitutions may result in fire electric shock or other hazards.

19. Safety Check : Upon completion of any service or repairs to this monitor ask the service technician to preform safety checks to determine that the monitor is in proper operating condition.

FCC & ICES Information

Warning

This equipment has been tested and found to comply the limits for a class A digital device pursuant to part 15 of the FCC Rules and ICES-003 of Industry Canada. These limits are designed to provide reasonable protection against harmful interference when the equipment is operated in a commercial environment. This equipment generate uses and can radiate radio frequency energy and, if not installed and used in accordance with the instruction manual may cause harmful interference to radio communications. Operation of this equipment in a residential area is likely to cause harmful interference in which case the user will be required to correct the interference at his own expense.

User-Installer Caution

Your authority to operate this FCC verified equipment could be voided if you make changes or modifications not expressly approved by the party responsible for compliance to part 15 of the FCC Rules.

Eng-7

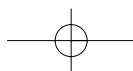

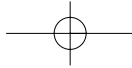

User Guide

Information to user

Changes or modifications not expressly approved by the party responsible for compliance could void the user's authority to operate the equipment.

NOTE: This equipment has been tested and found to comply with the limits for a Class A digital device pursuant to Part 15 of the FCC Rules. These limits are designed to provide reasonable protection against harmful interference when the equipment is operated in a commercial environment. This equipment generates uses and can radiate radio frequency energy and if not installed and used in accordance with the instruction manual may cause harmful interference to radio communications. Operation of this equipment in a residential area is likely to cause harmful interference in which case the user will be required to correct the interference at his own expense.

This device complies with Part 15 of the FCC Rules. Operation is subject to the following two conditions: (1) this device may not cause harmful interference and (2) this device must accept any interference received including interference that may cause undesired operation.

Changes or modifications not expressly approved by the party responsible for compliance could void the user's authority to operate the equipment. If necessary consult your dealer or an experienced radio/television technician for additional suggestions. You may find the booklet called How to Identify and Resolve Radio/TV Interference Problems helpful. This booklet was prepared by the Federal Communications Commission. It is available from the U.S. Government Printing Office Washington, DC 20402, Stock Number 004-000-00345-4.

Eng-8

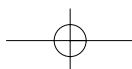

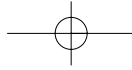

The party responsible for product compliance:
SAMSUNG ELECTRONICS CO., LTD.
America QA Lab of Samsung
3351 Michelson Drive,
Suite #290, Irvine, CA92612 USA

IC Compliance Notice

This Class (A) digital apparatus meets all requirements of the Canadian Interference-Causing Equipment Regulations.

Cet appareil numérique de la classe (A) respecte toutes les exigences du Règlement sur le matériel brouilleur du Canada.

This Class A digital apparatus complies with Canadian ICES-003.

Cet appareil numérique de la classe A est conforme à la norme NMB-003 du Canada.

Warning

This is a class A product. In a domestic environment this product may cause radio interference in which case the user may be required to take adequate measures.

Eng-9

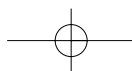

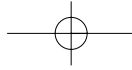

User Guide

Contents

IMPORTANT SAFETY INSTRUCTIONS	Eng-2
IMPORTANT SAFEGUARDS	Eng-4
FCC & ICES Information	Eng-7

Chapter 1: System Components and Installation

1-1) Environmental requirements for installation and safety ...	Eng-12
1-2) System Components	Eng-13
1-3) CAMERA composition and installation method	Eng-14
1-4) CAMERA Composition and Connecting Method to MONITOR	Eng-18
1-5) External terminal connecting method for CAMERA and MONITOR	Eng-19
1-6) Whole System connection and configuration.....	Eng-20

Chapter 2: MONITOR FRONT PANEL KEY Function and Using Method

2-1) TALK KEY	Eng-21
2-2) AUD/SP SEL KEY	Eng-21
2-3) VOL+/VOL- KEY	Eng-21
2-4) POWER SAVE- KEY	Eng-22
2-5) ALARM RESET- KEY	Eng-22
2-6) QUAD/PAGE- KEY	Eng-22
2-7) LIVE/VCR- KEY	Eng-22
2-8) PIP- KEY	Eng-23
2-9) FREEZE- KEY	Eng-23
2-10) SEQUENCE- KEY	Eng-23
2-11) ZOOM- KEY	Eng-23
2-12) POWER- KEY	Eng-23
2-13) ENTER- KEY	Eng-24
2-14) MENU- KEY	Eng-24

Eng-10

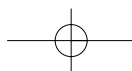

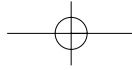

Chapter 3: Setting each item function at SETUP MENU

3-1) ADJUST MENU function and setting method	Eng-25
3-2) DATE/TIME MENU Function setting.....	Eng-26
3-3) DWELL TIME MENU function setting	Eng-26
3-4) DISPLAY MENU function setting	Eng-27
3-5) TITLE MENU Function setting	Eng-28
3-6) ALARM MENU Function setting.....	Eng-29
3-7) NETWORK SETUP function and setting method	Eng-30
3-8) SSC21WEB basic setting	Eng-38
3-8-1) "LIVE" MENU	Eng-40
3-8-2) System Configuration Menu	Eng-55
3-8-3) Network Configuration Menu.....	Eng-63
3-8-4) Monitor Set up.....	Eng-72
3-8-5) Utilities.....	Eng-73
3-9) VIEW EVENT LOG MENU function and setting method	Eng-85

Chapter 4: DISPLAY MODE setting method

4-1) SINGLE SCREEN DISPLAY	Eng-86
4-2) QUAD MODE DISPLAY.....	Eng-87
4-3) AUTO SEQUENTIAL DISPLAY MODE	Eng-88
4-4) PIP MODE DISPLAY	Eng-89
4-5) ZOOM MODE DISPLAY	Eng-90

Chapter 5: Each product feature

SOD14C (Standard Camera).....	Eng-91
SSC21WEB (Observaion Monitor)	Eng-92
SSC21WEB (NETWORK).....	Eng-93
Appendix A) Software up data	Eng-95
Appendix B) IP Router Setup Guide	Eng-96
1. Total System Configuration.....	Eng-97
2. Local System Configuration	Eng-98
3. Step-by-step Examples.....	Eng-99

Eng-11

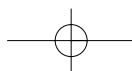

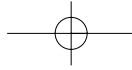

Chapter 1: System Components and Installation

1-1) Environmental requirements for installation and safety

This section describes the environmental requirements for safe installation and use.

Install the product on a flat table or in a rack. It should be used only when level and should not be used when stood vertically or obliquely. The location in which the main system is installed and the configuration of the wiring room are very important for proper operation of the system.

When the products are installed too closely together or the location is poorly ventilated, the system may not operate properly and maintenance of the system may be difficult. Sufficiently circulate the air within the system operating room and tightly fasten the cover of the main system to prevent malfunction and reduce system downs due to environmental causes.

There are high voltage parts inside. Do not arbitrarily open the cover.

Install the product in a place that meets the following environmental conditions. Be sure to maintain the system under the temperatures and humidity conditions given below:

- Operating temperature: 0°C ~ 40°C
- Storage temperature: -20°C ~ 60°C
- Operating humidity: 20% ~ 85% RH
- Storage humidity: 20% ~ 95 RH
- Input voltage: AC 120V
- Power usage: less than 110 Watts
- Frequency: 60Hz

Caution

When operating the product, the fluctuation of input voltage must be within 10% of the rated voltage and the external power outlet must be grounded, otherwise, it may cause electric shock or malfunction of the product. Do not connect heat-generating appliances such as a hair dryer, iron or refrigerator to the same power outlet in which the product is plugged, otherwise it may cause a fire or malfunction of the product. The use of an Automatic Voltage Regulator (AVR) is highly recommended to ensure that stable power is supplied. Be sure to coil CORE-FERRITE on the connector to reduce electro-magnetic interference (EMI).

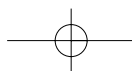

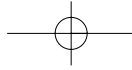

1-2) System Components

The system consists of the following:

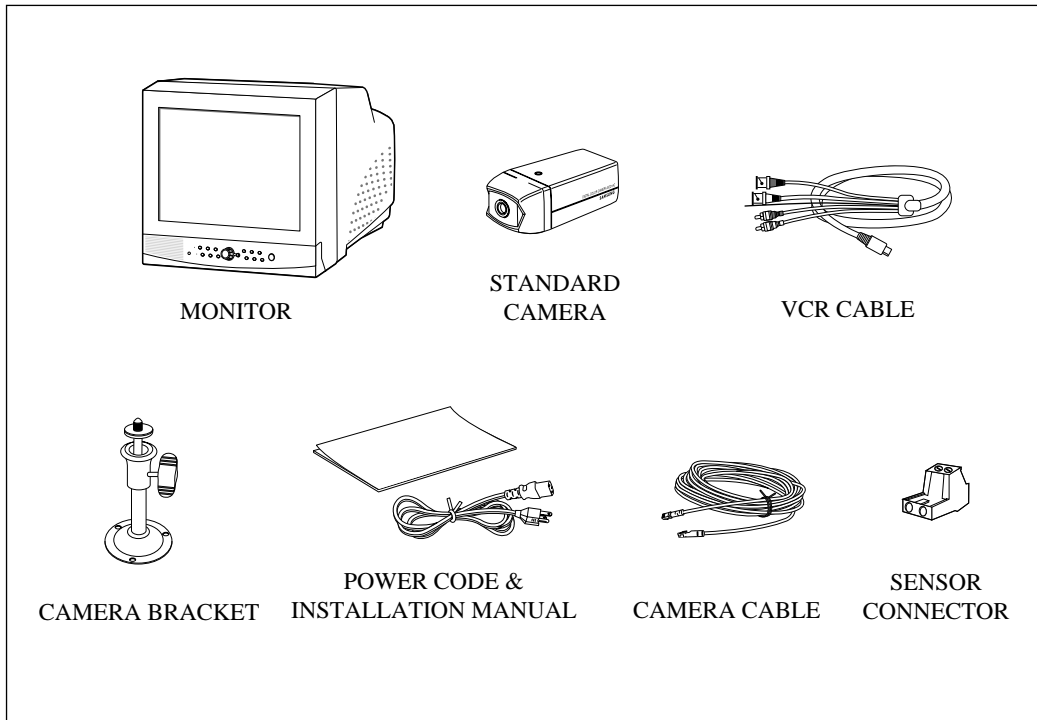

ITEM	MODEL	DESCRIPTION	Q'ty	NOTE
MONITOR	SSC21WEB	21" FLAT CRT MONITOR	1	
STANDARD CAMERA	SOD14C	NORMAL TYPE CAMERA	4	
CAMERA BRACKET	SBR-110	STAND TYPE BRACKET	4	Tapping Screw 3
CAMERA CABLE	MCB-60	6PIN SHIELD CABLE	4	60ft(1ft=0.3048m)
INSTALLATION MANUAL	-	-	1	
POWER CORD	-	-	1	
VCR CABLE	-	-	1	
SENSOR CONNECTOR	-	-	4	

- Check whether all the following devices and accessories are included with the main system.

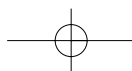

User Guide

1-3) CAMERA composition and installation method

1) Standard Camera composition (SOD14C)

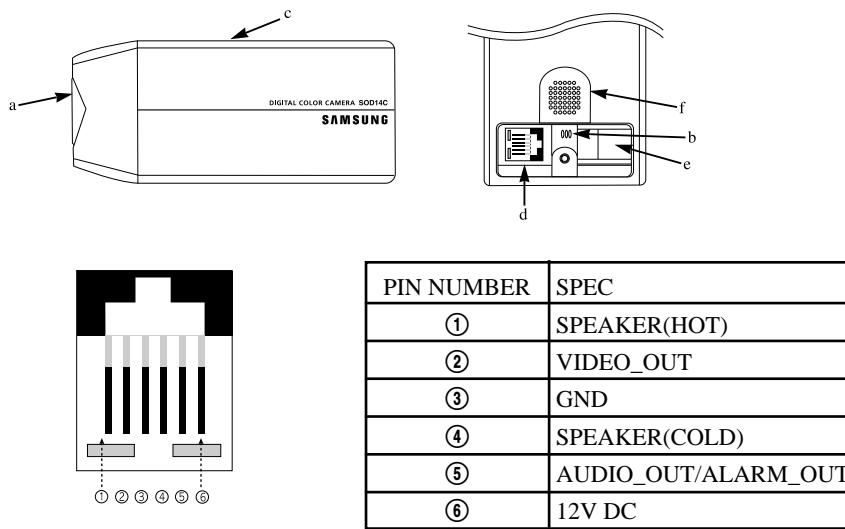

a. Lens

It has a focal length of 3.8mm and makes it possible for you to observe a relatively wide area.

b. Microphone

Capable of picking up all sound in the vicinity of the camera location and transmitting to the monitor.

c. Camera fitting groove

Enables the camera to be fixed onto the bracket. You may install it either above or below the camera if necessary.

d. 6-pin modular jack

Used to connect the camera to the monitor.

e. SENSOR jack

Used to connect the sensor to the camera.

Eng-14

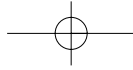

f. Speaker

It outputs the sound signal which was transferred from the monitor.

2) INSTALLING STANDARD CAMERA (SOD14C)

SOD14C s camera can be attached to the wall, ceiling or shelf using the camera mount bracket (SBR-110).

Choose an installation site that can sufficiently support the weight of the equipments to be installed.

Attach the camera mount bracket to the wall or ceiling using the supplied three screws (M4 X L15).

Adjust the camera to target the video location and tighten the bracket handle on the camera mount bracket.

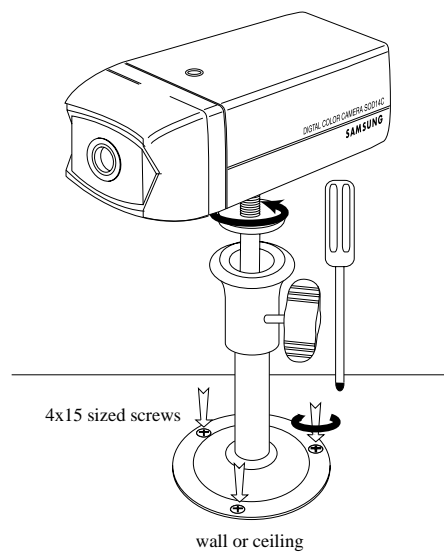

Eng-15

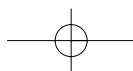

User Guide

3) CAMERA MOUNT BRACKET(SBR-110) & STANDARD CAMERA(SOD14C)

(1) Overview

CAMERA MOUNT BRACKET (SBR-110) is used to attach the camera to a wall, ceiling or shelf.

(2) Installation

Explains the installation of CAMERA MOUNT BRACKET as well as the installation of the camera onto the CAMERA MOUNT BRACKET.

- Choose an installation site that can sufficiently support the weight of the equipments to be installed.
- Attach the camera mount bracket to the wall using the supplied screws (M4 X L15).

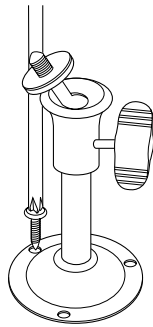

- Adjust the camera to target the video location and tighten the bracket handle on the camera mount bracket. Install the camera on to the male screw of the Camera Mount Bracket by rotating the camera in clockwise.

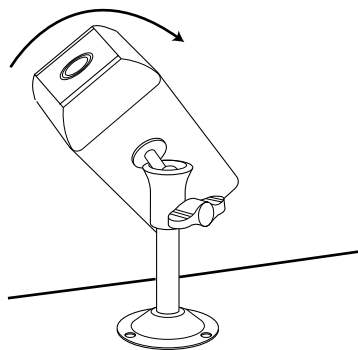

Eng-16

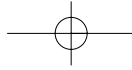

- Loosen the handle by turning it in a counter clockwise direction and then adjust the camera position . Tighten the handle, turning it clockwise, and lock the camera in position.
- Connect the camera cable to the camera.

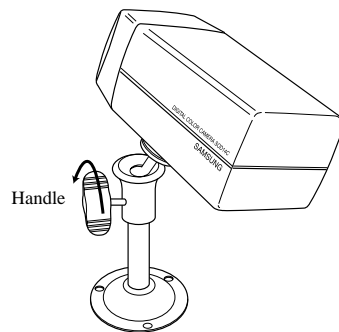

(3) Specifications

Use : Indoor

Installation : Wall or Ceiling

Dimensions : 57 (W) X 47.2(H) X 100.5(L)

Weight : 150g

Operating Temperature : -10°C ~ 50°C

(4) Accessories

SCREW (M4 X L15) : 3 pcs

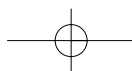

User Guide

1-4) CAMERA Composition and Connecting Method to MONITOR

After positioning monitor and installing four cameras to a desired location, please connect CAMERA to MONITOR through CAMERA CABLE (MCB-60) as shown in the below figure. Please check whether or not it is properly connected.

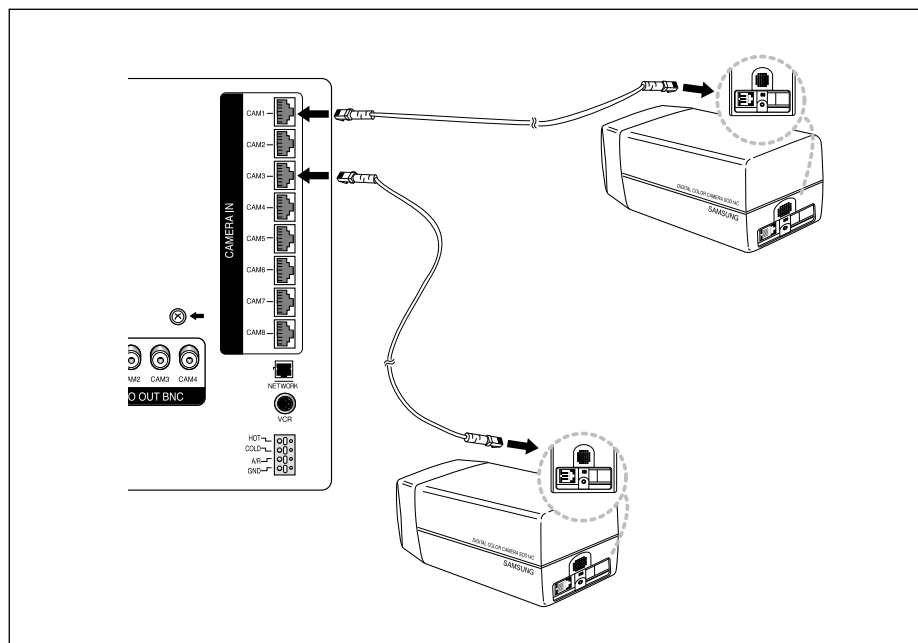

Connection status checking method :

- Turn on the monitor after connecting cameras, and check if camera image is displayed. The initial screen mode of monitor is quad mode.
- In case monitor and camera is not connected, OSD 'L'(LOSS) will be displayed on screen.

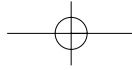

1-5) External terminal connecting method for CAMERA and MONITOR

1) External terminal connecting method for CAMERA

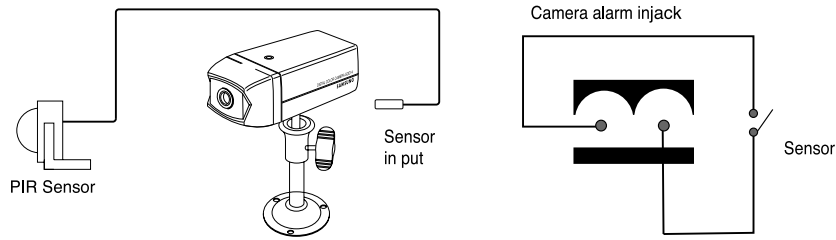

- An additional PIR sensor or external sensor can also be connected.
- The additional PIR sensor can be connected as shown in the above graphic.
- Sensor's trigger signal is NO (Normal Open).
- Sensor is not supplied. (Sold separately)

2) VIDEO OUT BNC (1~4) terminals connecting method of monitor rear

VIDEO OUT BNC1 ~ BNC4 terminals in the rear of the monitor are VIDEO terminals for outputting video images from OBSERVATION CAMERA to THROUGH OUT.

BNC VIDEO output terminal can be used to connect to VCR (TIME LAPSE) or SLAVE MONITOR.

3) VCR or ALARM terminal connecting method

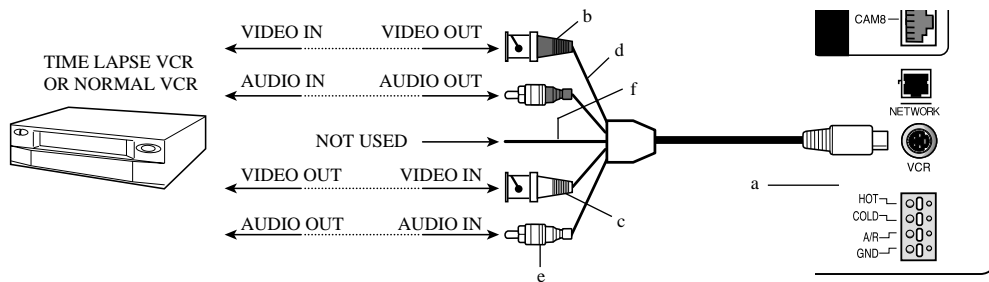

- Connect the 6-pin plug to the VCR terminal on the rear panel.
- Connect the VIDEO OUT plug to the VIDEO IN terminal of the VCR.
- Connect the VIDEO IN plug to the VIDEO OUT terminal of the VCR.
- Connect the AUDIO OUT plug to the AUDIO IN terminal of the VCR.
- Connect the AUDIO IN plug to the AUDIO OUT terminal of the VCR.

Eng-19

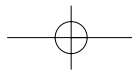

User Guide

- f) Not Used
- g) Connect the A/O (HOT) terminal on the rear panel to the Alarm IN terminal of the VCR.
- h) Connect the A/O (COLD) terminal on the rear panel to the Ground terminal of the VCR.
- i) Connect the A/R terminal on the rear panel to the Alarm Reset terminal of the VCR.
- j) Connect the G (ground) terminal on the rear panel to the Ground terminal of the VCR.

1-6) Whole System connection and configuration

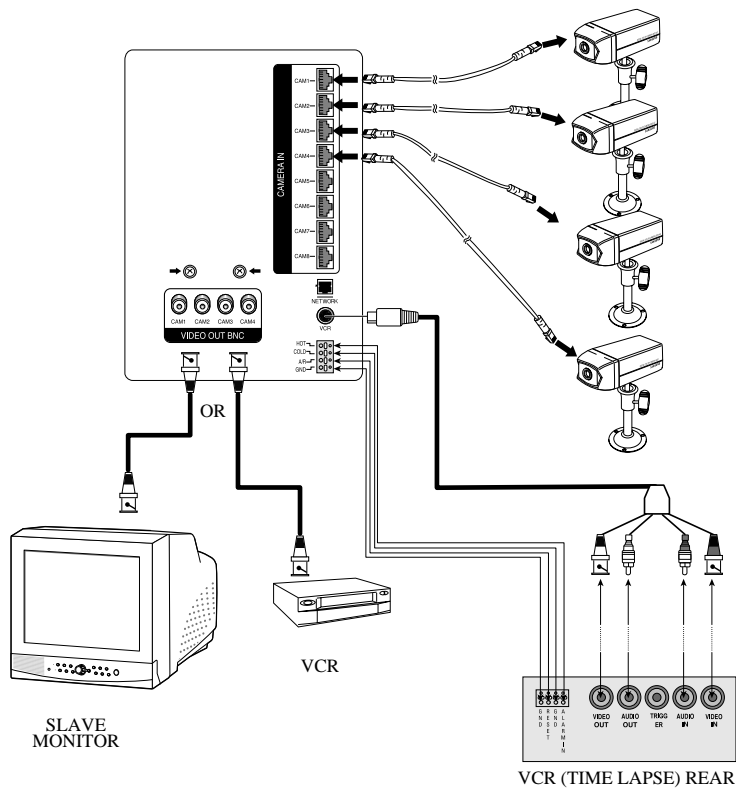

Eng-20

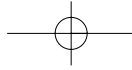

Chapter 2: MONITOR FRONT PANEL KEY Function and Using Method

Front Panel

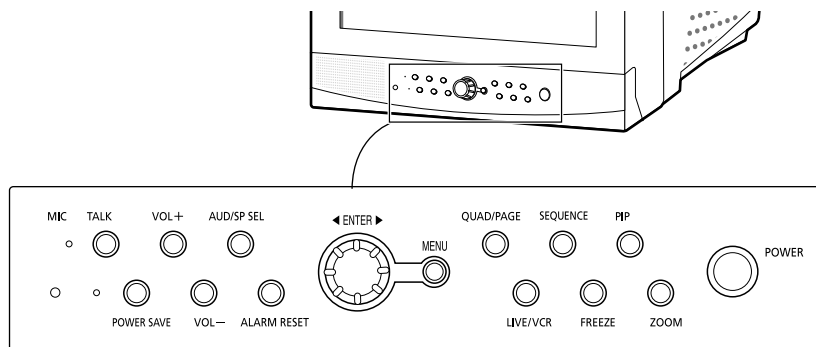

2-1) TALK KEY

TALK KEY allows users to transmit voice signal to intended camera by inputting voice with built-in MIC in the front of the monitor. For this function, select a target camera with the ◀ENTER▶ SWITCH on the FRONT PANEL, and press AUD/SP SEL KEY. At this time, if a voice signal is generated through the MIC with the TALK KEY pressed, the signal will be transmitted to the camera.

2-2) AUD/SP SEL KEY

AUD/SP SEL KEY allows users to select a camera to exchange voice signals with the monitor at QUAD DISPLAY MODE. At QUAD DISPLAY MODE, select target camera display by turning ◀ENTER▶ SWITCH left or right, and press AUD/SP SEL KEY. Then "S" OSD will be displayed on the selected screen. If you want to exchange voice signals with another camera, turn again the ◀ENTER▶ SWITCH again to select the camera display, and press AUD/SEL KEY. Then, "S" OSD will be displayed and users can exchange voice signals with the monitor.

2-3) VOL+/VOL- KEY

Allows users to decrease or increase voice signal generated from the monitor.

VOL+ : Increase sound volume from the monitor.

VOL- : Decrease sound volume from the monitor.

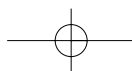

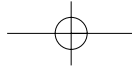

User Guide

2-4) POWER SAVE- KEY

Allows users to set POWER SAVE MODE of monitor. PICTURE screen is off when the POWER SAVE KEY is pressed, and the ON/OFF status of the monitor can be judged through LED ON/OFF status. Users can exit from POWER SAVE MODE by pressing POWER SAVE BUTTON again under picture "OFF" status. POWER SAVE MODE is automatically cancelled and picture is "ON" when an event such as an alarm or loss at POWER SAVE MODE occurs.

2-5) ALARM RESET- KEY

Alarm function can be cancelled while the alarm is working.

2-6) QUAD/PAGE- KEY

Allows users to display QUAD A or QUAD B at QUAD DISPLAY MODE.

- QUAD A: QUAD DISPLAY MODE from Camera 1 to Camera 4
- QUAD B: QUAD DISPLAY MODE from Camera 5 to Camera 8

2-7) LIVE/VCR- KEY

Allows users to switch LIVE MODE to VCR MODE or VCR MODE to LIVE MODE. If VCR MODE is cancelled, the QUAD picture of LIVE MODE will be automatically displayed. In case any event happens at VCR MODE such as LOSS or ALARM, the MODE will be automatically switched to LIVE MODE, and the pre-set operation for the event will be carried out. If there is no external input at VCR MODE, the OSD "NO SIGNAL" will be displayed.

- LIVE MODE: Image and voice signal from CAMERA is displayed.
- VCR MODE: External image and voice signal from VCR terminal from the rear of the monitor is displayed.

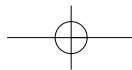

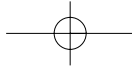

2-8) PIP- KEY

Can be used to see the main screen while Single screen is displayed. The main screen can be changed and transferred to another channel while PIP is working. Please refer to "CHAPTER 4. DISPLAY MODE SETTING" for PIP function and details.

2-9) FREEZE- KEY

This key allows users to see a target camera picture at PAUSE MODE. If users select the camera with the ◀ENTER▶ KEY, and press the FREEZE BUTTON, the OSD "F" will be displayed on pause picture from the camera. Other FRONT KEY input is ignored at FREEZE MODE, and other FRONT KEY inputs will be available only after the FREEZE MODE is cancelled.

2-10) SEQUENCE- KEY

It makes a picture switch sequentially. This means that display the picture will be displayed during the DWELL TIME pre-set at the DWELL MENU of SETUP MENU, and switch the picture automatically as a pre-set sequence. Please refer to Chapter 3. DWELL TIME MENU function and setting method for details of DWELL TIME setting.

2-11) ZOOM- KEY

It zooms a part of a picture doubling it in the display. If the ZOOM BUTTON is pressed, zoom area will be displayed. Users can move to a target area by turning ◀ENTER▶ SWITCH left and right at this time. If ◀ENTER▶ SWITCH is pressed at the target area, the area will be displayed with 2 times larger.

2-12) POWER- KEY

It turns ON/OFF the power of the monitor and camera at the same time.
In case the monitor power is ON, LED of monitor front is lit.

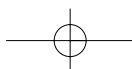

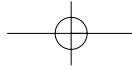

User Guide

2-13) ENTER- KEY

As a multi functional ◀ENTER▶ key, it allows users to 1. enter SET UP MENU movement and SETTING MODE and set data, and 2. display single camera picture.

Please refer to the below picture.

- ◀ENTER▶ SWITCH using method at MENU setting

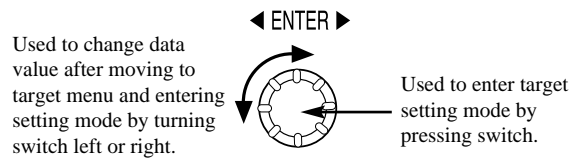

- SINGLE DISPLAY MODE Entering and Function

At QUAD DISPLAY or SEQUENTIAL SWITCHING MODE, pressing the ◀ENTER▶ SWITCH allows users to enter the SINGLE DISPLAY MODE to see the image of one selected camera at full screen. Users can move to another camera image by the ENTER SWITCH turning left and right.

2-14) MENU- KEY

It allows users to enter SETUP MENU, and set the following items on the SETUP MENU.

- ADJUST : Screen adjustment
- DATE/TIME MENU : Setting of Date/Time format and time to be displayed
- DWELL MENU : Setting of DWELL TIME at SEQUENTIAL SWITCHING MODE
- DISPLAY MENU : Setting DISPLAY MODE
- TITLE MENU : Setting camera name
- ALARM MENU : Setting ALARM and BUZZER
- VIEW EVENT LOG MENU : Allows users to see EVENT (ALARM, LOSS) list per time, camera

Please refer to the following Chapter 3 for setting method and function of SETUP MENU per item.

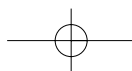

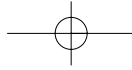

Chapter 3: Setting each item function at SETUP MENU

Pressing the MENU BUTTON of the FRONT PANEL allows users to enter SETUP MENU and see the following menu OSD box. Setting method of each SETUP MENU function and operation is as follows.

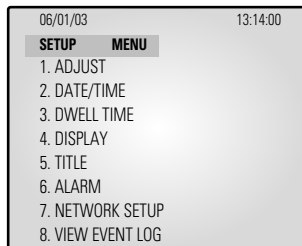

3-1) ADJUST MENU function and setting method

- **Function:** Allows adjustment to the display status
- **Setting method:** Move to #1. ADJUST MENU by using ◀ENTER▶ SWITCH and press the ENTER SWITCH to display the OSD as shown in the figure below. (The figure shows the initial setting status.)

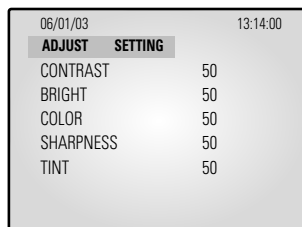

Move to a target item by turning ◀ENTER▶ SWITCH left or right.

Enter the item by pressing the ◀ENTER▶ SWITCH.

At this time, set a target value by turning ◀ENTER▶ SWITCH left or right

You can move to another item by pressing again the SWITCH after setting the target value.

- (1) **CONTRAST** : Adjusts light and shade of screen
- (2) **BRIGHT** : Adjusts lightness of entire screen
- (3) **COLOR** : Adjusts color density
- (4) **TINT** : Adjusts color sense
- (5) **SHARPNESS** : Adjusts contour of screen

Eng-25

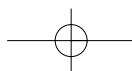

User Guide

3-2) DATE/TIME MENU Function setting

- **Function:** Sets the display date format and current time.
- **Setting method:** Move to #2. DATE/TIME MENU by using ◀ENTER▶ SWITCH at setup menu, then press the ENTER SWITCH to display the OSD as shown in the below figure. (The figure shows the initial setting status.)

06/01/03	13:14:00
DATE/TIME SETTING	
DATE TYPE	MM/DD/YY
DATE	06 / 01 / 03
TIME [HH:MM:SS]	13 : 14 : 00

- **Setting method of date display format**
Move to the format item by turning ◀ENTER▶ SWITCH, and enter the mode for setting date format by pressing the ENTER SWITCH.
At this time, select a target date format by turning left and right the SWITCH.
(“YY/MM/DD”, “MM/DD/YY”, “DD/MM/YY” are available for selectable data format.)
- **Date and current time setting method**
Repeat the above instruction for moving to each item (MONTH, DAY, YEAR, HOUR, MINUTE, SECOND) and entering the mode. Current date and time to display can be set. (It can be referred when ALARM or LOSS occurs.)

3-3) DWELL TIME MENU function setting

- **Function:** Displays each picture for pre-set time and automatically switches it to the next picture at SEQUENTIAL DISPLAY MODE.
- **Setting method:** Move to #3. DWELL TIME menu by using ◀ENTER▶ SWITCH at SETUP MENU, and press the ENTER SWITCH to display the following OSD as shown in the below figure. (The figure shows the initial setting status.)

06/01/03	13:14:00
DWELL TIME SETTING	
CAM1	03 SEC
CAM2	03 SEC
CAM3	03 SEC
CAM4	03 SEC
CAM5	03 SEC
CAM6	03 SEC
CAM7	03 SEC
CAM8	03 SEC
QUAD-A	03 SEC
QUAD-B	03 SEC

Eng-26

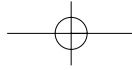

If the time is set for each camera channel by using ◀ENTER▶ SWITCH, each camera picture will be displayed for the set time and switched to the next picture automatically.

3-4) DISPLAY MENU function setting

- **Function:** Allows users to select the color and ON/OFF of borderline at QUAD DISPLAY.
- **Setting method:** Move to #4. DISPLAY SETTING MENU by using ◀ENTER▶ SWITCH at SETUP MENU, then press the ENTER SWITCH to display the OSD as shown in the figure below. (The figure shows the initial setting status.)

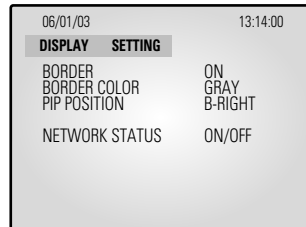

Move to each item by using ◀ENTER▶ SWITCH, and change the set value.

- 1) BORDER item determines whether or not boarder line is displayed at QUAD DISPLAY MODE.
(ON: Displays the boarder line, OFF: Does not display the boarder line)
- 2) BORDER COLOR item sets boarder line color among three colors: Black, White, Gray.
- 3) PIP POSITION item sets the location of sub picture at PIP DISPLAY. (T-LEFT: Upper part of left side, T-RIGHT: Upper part of right side, B-LEFT: Lower part of left side, B-RIGHT: Lower part of right side)
- 4) NETWORK STATUS determines the display of [S], [D], [P] displayed at the left of top on the screen according to status of NETWORK.
Refer to 3-7) NETWORK SETTING function and setting method for the respective detailed status.
(ON: Displays the NETWORK STATUS, OFF: Does not display the NETWORK STATUS)

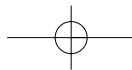

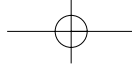

User Guide

3-5) TITLE MENU Function setting

- **Function:** Set the title of each camera at your discretion.
- **Setting method:** Move to #5. TITLE MENU by using ◀ENTER▶ SWITCH at SETUP MENU, and press the ENTER SWITCH to display the OSD as shown in the figure below. (The figure shows the initial setting status.)

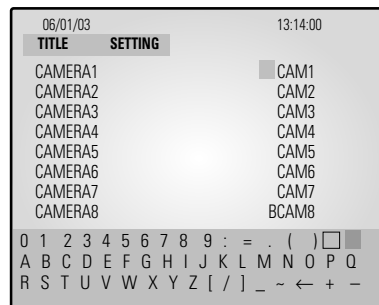

Move to a target camera channel by using ◀ENTER▶ SWITCH then press the ENTER KEY to display a cursor at the space of the first character of camera title. Move the cursor to a target character in OSD box of lower part by turning left and right ◀ENTER▶ SWITCH left or right, then press the ENTER KEY to set the character. The cursor automatically moves to the next space for a new character after one character is set. Set the title of camera by repeating the same method.

(Only eight characters are available for a camera title.)

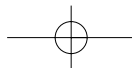

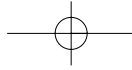

3-6) ALARM MENU Function setting

- **Function:** Allows users to set the ALARM MODE for each camera.
- **Setting method:** Move to #6. ALARM MENU by using ◀ENTER▶ SWITCH at SETUP MENU, and press the ENTER SWITCH to display the OSD as shown in the figure below. (The figure shows the initial setting status.)

06/01/03		13:14:00
ALARM	SETTING	
CAM1		ON
CAM2		ON
CAM3		ON
CAM4		ON
CAM5		ON
CAM6		ON
CAM7		ON
CAM8		ON
HOLD TIME		05SEC
ALARM ON TIME		00:00
ALARM OFF TIME		00:00
BUZZER		ON

- (1) CAM1 to CAM8 item sets whether the alarm sensor connected to the camera is used or not.
(ON: Alarm function setting, OFF: Alarm function canceling)
 - (2) HOLD TIME item sets time to freeze alarm operation when alarm occurring.
(HOLD TIME to be set: 05SEC ~ 1MIN ~ 30MIN)
 - (3) ALARM ON/OFF TIME item sets beginning time (ON) and end time (OFF) that monitor recognizes alarm operation as alarm event.
- * Note : Even if CAMERA ALARM is set to ON, alarm operation is not carried at time band except pre-set ALARM ON/OFF TIME.
- (4) BUZZER item sets whether or not buzzer device set in monitor is used at an ALARM or LOSS occurring.
(ON: Buzzer operation, OFF: NA)

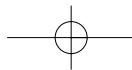

User Guide

3-7) NETWORK SETTING function and setting method

- **Function:** Allows users to select the STATIC (fixed) IP, DHCP, PPPoE of Setting.
- **Setting method:** Move to #7, NETWORK SETUP MENU by using **◀ENTER▶** SWITCH at SETUP MENU, then press the ENTER SWITCH to display the OSD as shown in the figure below.
(The figure shows the initial setting status)

06/01/03	13:14:00
NETWORK SETTING	
1. NETWORK ACCESS	STATIC.../DHCP.../PPPoE...
2. HTTP PORT	00080
NETWORK STATUS	
IP ADDR	192.168.1.200
GATEWAY	192.168.1.65
SUBNETMASK	255.255.255.0
DNS 1	168.126.63.001
DNS 2	168.126.63.002
MAC ADDR	00:30:6f:ff:00:00

MOVE TO EACH item by using **◀ENTER▶** switch, and change the set value.

Static IP User

- Constituted by Static IP on the TCP/IP network

- 1) Move to 'STATIC...' by using **◀ENTER▶** at NETWORK ACCESS, then press ENTER SWITCH to set STATIC...

(STATIC : Select in case the network configuration of SSC21WEB is fixed IP (Public or Private IP))

06/01/03	13:14:00
STATIC ACCESS	
IP ADDR	192.168.1.200
GATEWAY	192.168.1.65
SUBNETMASK	255.255.255.0
DNS 1	168.126.63.001
DNS 2	168.126.63.002

- 2) Move to IP ADDR / GATEWAY / SUBNETMASK by using **◀ENTER▶**.
- 3) Press ENTER SWITCH and type in IP ADDR / GATEWAY / SUBNETMASK respectively.
- 4) DNS 1 and DNS 2 will be automatically set to DNS as shown below.
Use **◀ENTER▶** switch to change it.

Eng-30

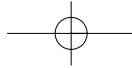

- 5) After setting, move to the main screen by using the MENU BOTTOM.
- 6) Set values will be stored shown below. It takes 2 or 3 seconds.

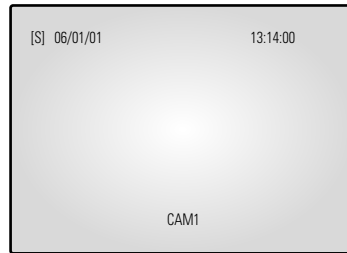
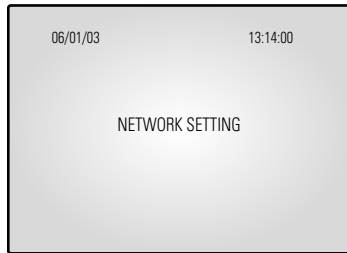

On completion of setting to Static IP(Fixed IP)setup, the screen, [S] is displayed.
If the network connection is cancelled or cut, [S] starts blinking.

Open your Internet Explorer web browser.

- 7) Using a Static (fixed) IP, You may also connect remotely by typing in the IP address of the SSC21WEB, Such as
http://192.168.1.200

*** Note : HTTP Port**

Set the port to be used when connection to SSC21WEB in internet Explorer and receive Necessary files for the image transmission.

The port setting is used for various network configuration or a particular port etc.

CAUTION

A port number is reserved for TCP port and HTTP port setting.

Default values should not be changed.

However, if the IP Router is used in a network environment, input proper values with reference to the IP Router manual.

If the SSC21WEB is using a Router, you may also connect remotely by typing In the WAN IP Address of the Router and the HTTP port assigned to the SSC21WEB.

(here you must type in the port address even if it is the default "80"), such as

http://192.168.1.200:80

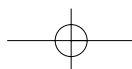

User Guide

DHCP User

- Constituted by Dynamic IP on the cable/xDSL modem network

You can use the SSC21WEB products through the network using Dynamic IP on cable/xDSL modem. In this case, it should be connected with DDNS to support the Dynamic IP.

In case a user (EX : cable modem user) does not need ID and password of the communications that he subscribes for when he logs on to he internet, he may provide the configuration using DHCP.

In case of a configuration using DHCP, as the connection to SSC21WEB is made using domain names (EX : <http://sff0000.websamsung.net>) that are automatically registered in our DDNS server, IP address, Subnet Mask and Gateway that are in the network tab of Admin Mode are not necessarily to be inputted.

The proper domain names of SSC21WEB are automatically registered to DDNS server installed in our company in case of modem connection.

Beside, IP type of Admin Mode is made of "DHCP" in case of factory shipment, you may apply directly without a setting of Admin Mode, as IP type of Admin Mode for the factory shipment is of "DHCP".

- 1) Connect as the figure below and turn on the power of each equipment in the following order.

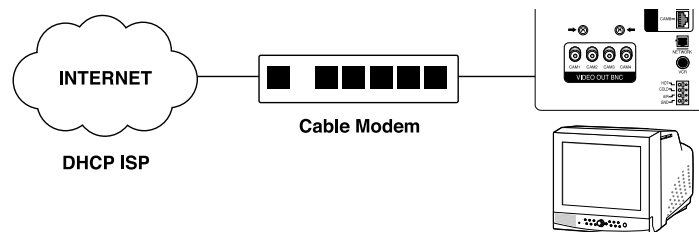

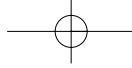

- 2) Move to 'DHCP...' by using **◀ENTER▶** at NETWORK ACCESS, then press ENTER SWITCH to set to DHCP.

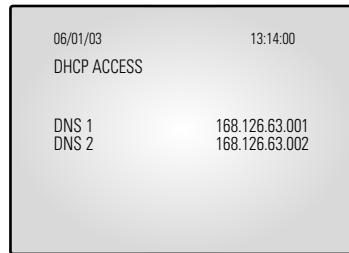

- 3) DNS 1 and DNS 2 will be automatically set to DNS as shown below.
Use **◀ENTER▶** switch to change it.
- 4) After setting, move to the main screen by using the MENU BOTTOM.
- 5) Set values will be stored as shown below. It takes 2 or 4 seconds.



On completion of setting to DHCP setup, the screen, [D] is displayed.
If the network connection is cancelled or cut, [D] starts blinking.

- 6) You can view the video source of the SSC21WEB from a remote location PC.
- 7) Make sure the remote PC meets the minimum specification requirements described in chapters 1 and 2, and make sure that the PC is internet capable and set up to be able to browse the internet.

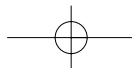

User Guide

8) Open your Internet Explorer web browser, type in the following in the URL window and press Enter.

`http://sff0000.websamsung.net`

Where ff0000 is the MAC address of your SSC21WEB in this example.

If your SSC21WEB's MAC address is ff0001, then type in ff0001 instead of ff0000

*** Note : MAC Address.**

Locate the MAC Address of the SSC21WEB (each SSC21WEB has its own unique MAC address)

It can be checked in '7.NETWORK SETUP' of SETUP MENU'.

It is the last 6 digits as shown below.

06/01/03	13:14:00
NETWORK ACCESS	OFF
NETWORK STATUS	
IP_ADDR	192.168.1.200
GATEWAY	192.168.1.65
SUBNETMASK	255.255.255.0
DNS 1	168.126.63.001
DNS 2	168.126.63.002
MAC_ADDR	00:30:6f:ff:00:00
CURRENT MODE	STATIC

CAUTION

If you change the HTTP port number 80 to 82 then must type like below in address bar.

`http://sff0000.websamsung.net:82`

At this time, you should add "s" in front of "mac address".

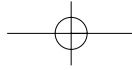

ADSL User (PPPoE)

- Constituted by IP on PPPoE (ADSL)

SSC21WEB products can be used on the network using IP through PPPoE (ADSL).

In case of a user (EX : ADSL user) who needs ID and password of the communications that he subscribes for in case of internet connection, the configurations using PPPoE would be available.

In case of a configuration using PPPoE, SSC21WEB connection is made through the domain names (EX : <http://sff0000.websamsung.net>) that are automatically registered in our DDNS server, you do not need to enter IP address, Subnet Mask and Gateway in the network tab of Admin Mode.

The proper domain names of SSC21WEB are automatically registered to DDNS server installed in our company in case of ADSL modem connection.

- 1) Connect as the figure below and turn on the power of each equipment in the following order.

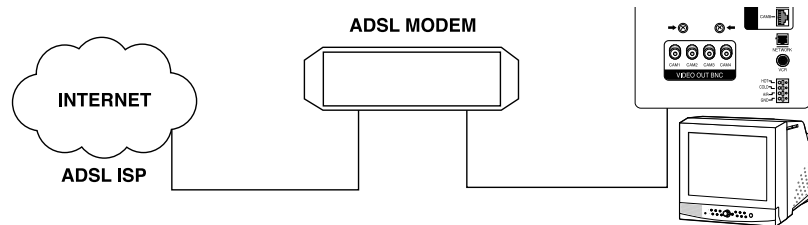

- 2) MOVE TO EACH item by using ◀ENTER▶ switch, and change the set value.
- 3) Move to 'PPPoE...' by using at NETWORK ACCESS.
Press ENTER SWITCH to set to PPPoE.

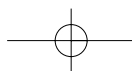

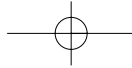

User Guide

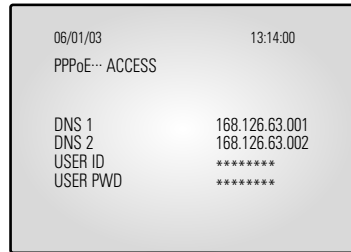

- 4) When the PPPoE (ADSL) type in the User Name and Password (and Confirm Password) given to you by the ADSL Service Provider.

CAUTION

In case of using ADSL (ISP-internet service provider, you must type correct User Name and Password by ISP to connect to SSC21WEB. If you type incorrect User Name or Password, you can not see the image transferred from SSC21WEB.

IP and PASSWORD can be inputted to 40 characters in the maximum.

- 5) USER ID and PWS can be 40 digits maximum. Only the Arabic numerals, @ and small characters can be used.
Please that capital letters are not supported when you get USER ID AND PWS from ADSL Service Provider.
- 6) DNS 1 and DNS 2 will be automatically set to DNS as shown below.
- 7) Use **◀ENTER▶** switch to change it.
- 8) After setting, move to the main screen by using the MENU BOTTOM.
- 9) Set values will be stored as shown below. It takes 2 or 3 seconds.

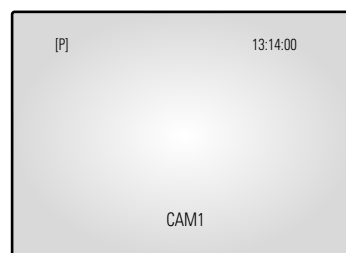

On completion of setting to PPPoE(ADSL)setup, the screen, [P] is displayed.
If the network connection is cancelled or cut, [P] starts blinking.

Eng-36

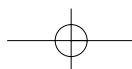

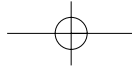

- 10) You can view the video source of the SSC21WEB from a remote location PC.
- 11) Make sure the remote PC meets the minimum specification requirements described in chapters 1 and 2, and make sure that the PC is internet capable and set up to able to browse the internet.
- 12) Open your Internet Explorer web browser, type in the following in the URL window and press ENTER.
 http://sff0000.websamsung.net (Indicate all by URL picture)
 Where ff0000 is the MAC address of your SSC21WEB in this example.
 If your SSC21WEB's MAC address is ff0001, then type in ff0001 instead of ff0000.

*** Note : MAC Address.**

Locate the MAC Address of the SSC21WEB (each SSC21WEB has its own unique MAC address)

It can be checked in '7.NETWORK SETUP" of SETUP MENU'.

It is the last 6 digits as shown below.

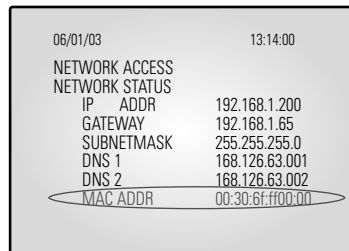

CAUTION

If you change the HTTP port number 80 to 82 then must type like below in address bar.
 http://sff0000.websamsung.net:82

CAUTION

In cases where DNS server address of PC is not set and the connection using domain name is not available, Please consult with the network administrator and be sure to set DNS server address.

At this time, you should add "s" in front of "mac address".

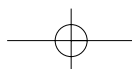

User Guide

CAUTION

The connection to SSC21WEB is unavailable for about 2~5 minutes after ADSL Modem's power ON.

Since the connection would not be available, as IP is not received from ADSL communications, please reboot by turning off the power of ADSL Modem and SSC21WEB for more than 5 seconds and then try to connect again.

3-8) SSC21WEB basic setting

- 1) Open your Internet Explorer web browser, type in the following in the URL window and press ENTER. -Refer 3-7) Network Installation
- 2) When you choose the Admin menu, it asks you the Admin ID and password.
- 3) Type in root / root. On delivery, they are "root" (administrator's ID) / "root" (administrator's Password). The password can be changed on Admin Menu.



- 4) If this is the first time you run this procedure on this PC, then you will see the following "Active X controls and plug-ins to run" screen.

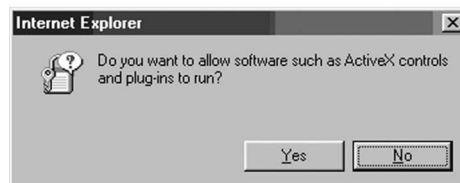

- 5) Click "YES". This will automatically download the necessary Active X Controls to operate the Remote Viewer.

It takes about 20 seconds at the first connection.

Eng-38

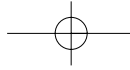

6) When you enter properly, a window appears as shown below.

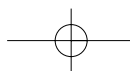

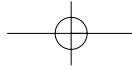

User Guide

3-8-1) "LIVE" MENU

- CAMERA SELECT

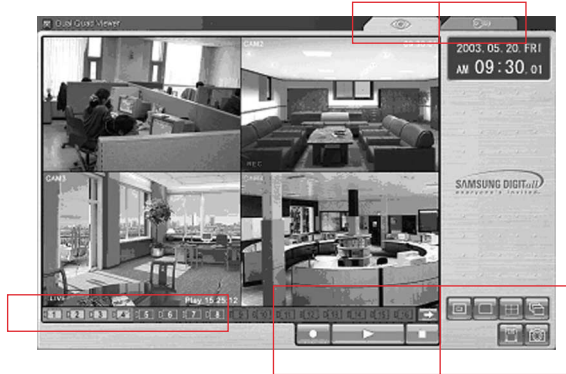

Initial display mode of monitor if QUAD A.

- Remote Viewer Function Buttons

KEY Type	Function
	Choose a camera by channel Ch 1 ~ Ch 8
	CHANNEL NEXT
	SINGLE MODE (1ch Default selected) 320 X 240 Size 720 X 480
	QUAD MODE (QUAD Default selected)
	SEQUENCE MODE
	SAVE
	CAPTURE
	REC

Eng-40

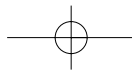

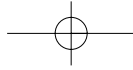

	PLAY
	STOP
	LIVE MODE change
	ADMIN MODE change

- SINGLE SCREEN DISPLAY

In case users want to see the camera image at full mode,
 Select a target camera by turning camera select key.
 After that it' selected camera image will be displayed at full screen.

- * AT SINGLE DISPLAY
 Original Size Large Size

- QUAD MODE DISPLAY

User can switch SINGLE DISPLAY and SEQUENTIAL DISPLAY MODE or QUAD
 DISPLAY MODE or QUAD A (QUAD B) TO QUAD B (QUAD A) Press the
 Sequence KEY

- AT QUAD MODE DISPLAY



QUAD A : QUAD DISPLAY MODE From Camera1 to Camera4
 QUAD B : QUAD DISPLAY MODE From Camera5 to Camera8

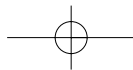

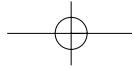

User Guide

- Auto SEQUENCY DISPLAY MODE

Pressing on the SEQUENCE KEY on the front allow to automatically switch to SINGLE MODE Full screen or QUAD MODE.

If the DWELL TIME SETTING of SETUP MENU is set to 3 seconds and the SEUQUENCY KEY is pressed at this time, the operation will be carried out as follows.

(NO signal channel will be skipped while single screen is auto-switching)

* SINGLE MODE SEQUENCE DISPLAY

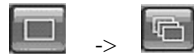

Press SQUENCE KEY When SINGLE MODE (camera select key) is displayed at full screen.

* QUAD MODE SEQUENCE DISPLAY

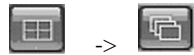

Press SQUENCE KEY When QUAD A (QUAD B) MODE is displayed.

- SAVE MODE



Pressing on the SAVE KEY on the front, you can change the name of the DIRECTORY.

- CAPTURE MODE



Pressing on the CAPTURE KEY on the front, you can store each picture in the form of M-JPEG.

- Motion Picture Recording and Playback

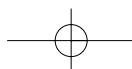

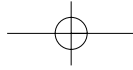

1. Recording



When you make a recording from the Viewer, the file is automatically saved onto a directory preset by the Viewer by default.

This directory is usually "C:\Program Files\Samsung \SSC21WEB\00-30-6F-FF-00" 00-30-6F-FF-00 is the MAC ADDRESS of the product.

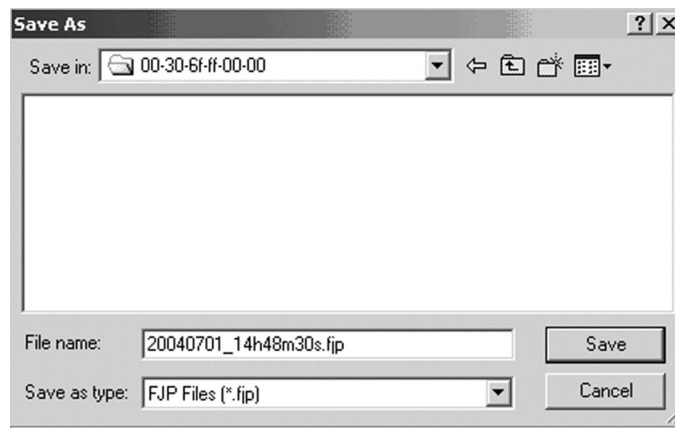

(user can change this in the SAVE KEY  .Record Folder setting),

where "Server Name" is the name of your SSC21WEB you have given during setup of the SSC21WEB.

If you have connected to and recorded from more than one SSC21WEB on the same PC, there will be more than one "Server Name" directory.

You can always locate the file by choosing the Server Name directory.

Within the Server Name directory, files are automatically saved with filenames in time stamped format.

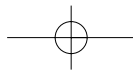

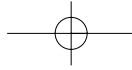

User Guide

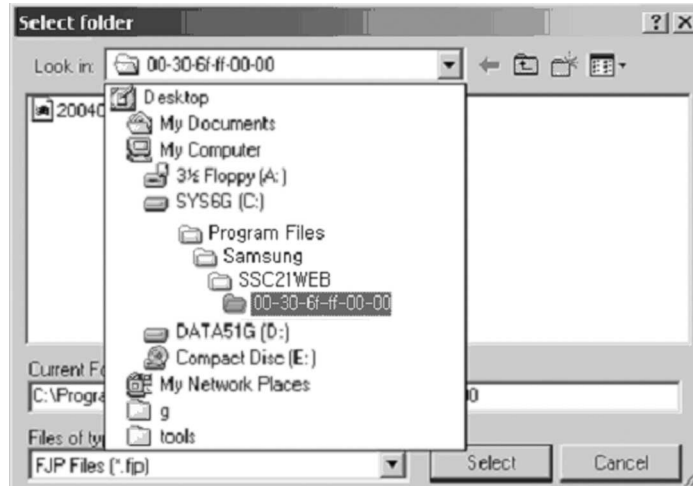

2. PLAY



When you select on a play key and press the Open button or double click the file, that file will play back on the Remote Viewer as a motion clip. When the file has finished playing or when you press the Stop button, the Remote Viewer will go back to Live screen. You can select several files simultaneously at once (up to 10) and the files will be played back in the order of the file name (by date and time).



Eng-44

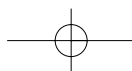

3. PLAYER

- Player installation/execution/deletion

- Installation

Player will be installed together when it is connected to SSC21WEB.

- Execution (Follow the instruction to execute it separately.)

Click Start Program → SSC WEB Control → Player. (Fig. 3-①)

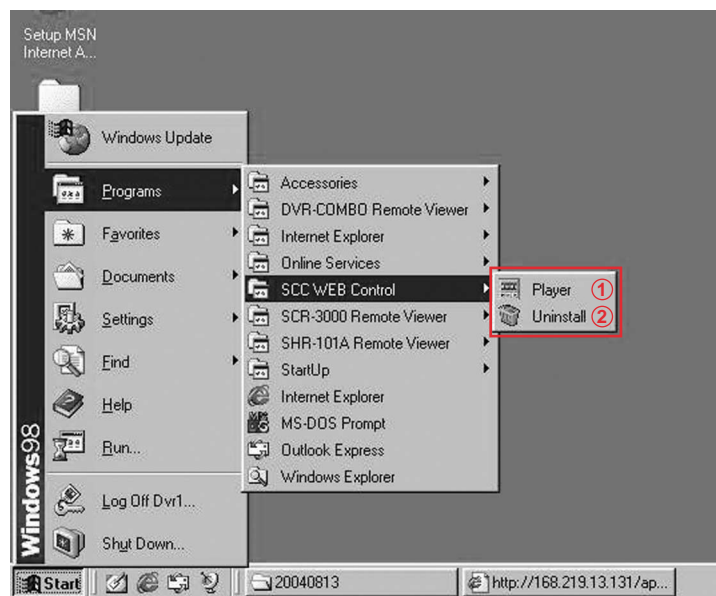

FIG.3

- Deletion

Click Start → Program → SSC WEB Control → Uninstall. (Fig. 3-②)

User Guide

- Program screen configuration

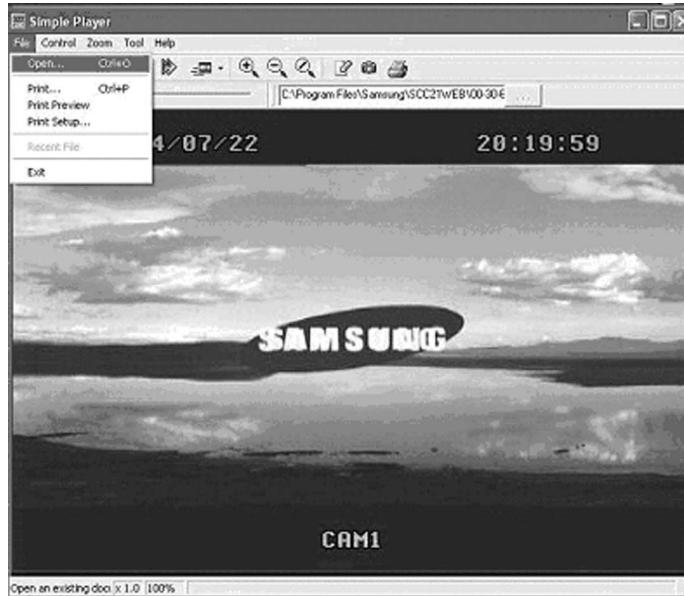

- How to play

1. Play - back

File - Open... Selecting this, you can choose one between fjp and jpg on a window as shown below.

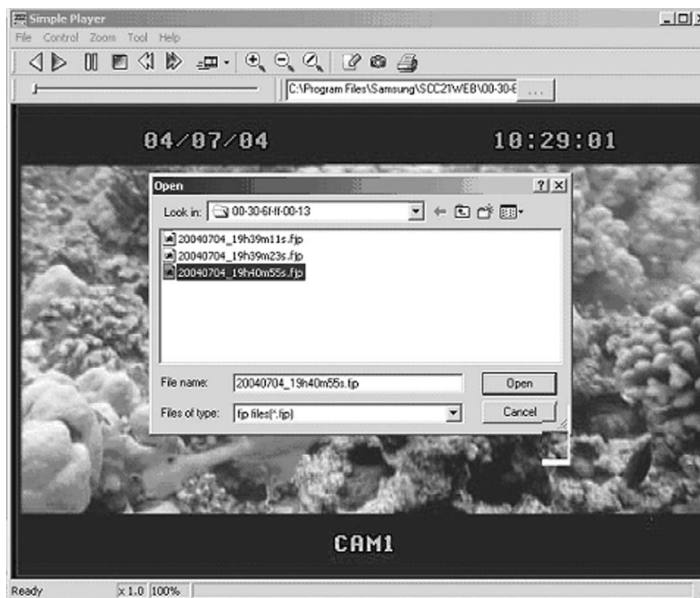

Eng-46

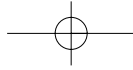

Having chosen and opened a file, you will see a picture as shown below.



	Reverse playback		Enlarge
	Playback		Reduce
	Pause		Original size
	Stop		Partial storing(AVI support)
	To the back frame		Save the present frame as a JPEG image
	To the front frame		Print
	Speed control	Status bar	Display the playback speed, magnification, and information on the storage.

Eng-47

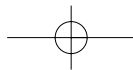

User Guide

Additional function (Tool)

- Partial recording
- Snap shot
- Print

- Partial Recording

Partial recording is to separate a section from the file selected and played and save it as a form of AVI.

Select  in the toolbar and a window will appear as shown below. Start time and End time of the file will be displayed and the user can decide the section.

You need to type in the correct time to execute the partial recording function.



Go to File setting and type in the file name you want to make. A window will appear as shown below.



And press 'Save'.



Then press 'Record' button and the picture below shows that it was completed.



* **Note :** **“AVI file frame speed setting”** Frame control function of Dialogue box is to control the number of frames of AVI files. Although the original file has been recorded at a speed of 10 frames per second, 30 frames or 3-second frames of the original file will be stored and become a “second in an AVI file if you set the number of AVI file frames to 30 frames. In this case, the AVI file will be played more rapidly than the speed of the original when it is played on a media player. Please regulate the “AVI file frame speed setting” properly depending on the speed of the original.

User Guide

- Snap shot

It is a function to save the present image as a form of a jpeg file. Select  in the toolbar. The result will be as follows.

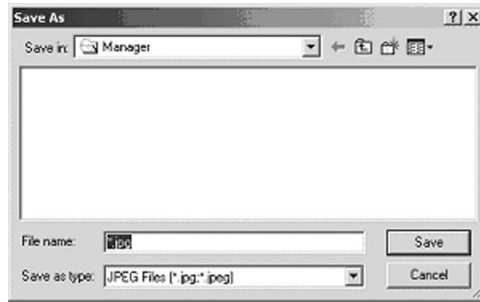

Type in the file name and press 'Save' to store it as a jpeg file.

- Print

It is a function to print the present image. Select  in the toolbar. The result will be as follows.



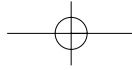

Type in the phrase you added in 'Description'. Then press the 'OK' button.

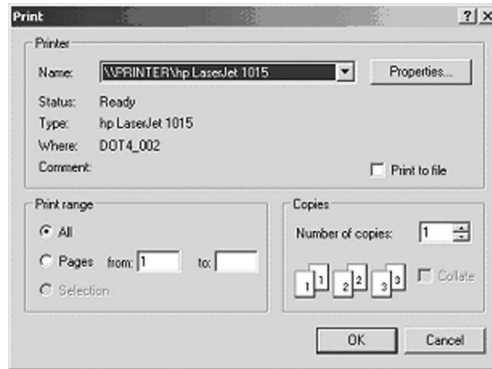

Select Print and press 'OK'.

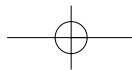
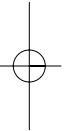
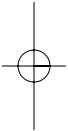

User Guide

Admin Menu

It is an administrator's menu to set the general items on SSC21WEB Server. To use this menu, you need the administrator's ID and Password.

On delivery, they are "root" (administrator's ID) / "root" (administrator's Password). The password can be changed on Admin Menu.

Admin Menu Entering

- 1) Click the Admin menu and a login window will appear.



- 2) When you connect to the SSC21WEB Server through Web browser, the initial screen will be as follows.



- 3) Type in the administrator and password in the user's name and password columns and press Enter key to execute the Admin Menu as shown below.

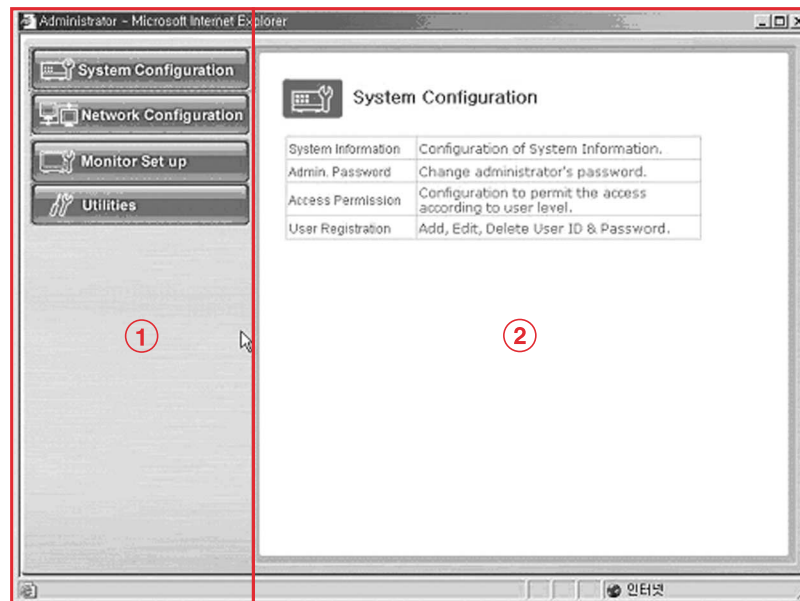

4) Screen configuration

- ① : General menus of Admin Menu. The menus related to SSC21WEB Server are divided into System, Network, Monitor Setup, and Utilities in the main. Each of them has several sub menus.
- ② : When you click one of the main menus (System Configuration, Network Configuration, Monitor Setup, Utilities), its sub menus and simplified explanation on them will appear.

User Guide

• Admin Menu Structure

Category	Main Menu
System Configuration	System Information
	Admin. Password
	Access Limitation
	User Registration
	Video
	Alarm Notification
Network Configuration	Network Configuration
	PPPoE (ADSL)
	Network Ports
	View Network Status
	Network Status Notification
	DDNS Configuration
Monitor Setup	Date & Time
	View Event Log
	Display
	Dwell Time
	Title
	Alarm
Utilities	Save Configuration
	Reboot
	System Update

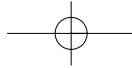

3-8-2) System Configuration Menu.

1. System Information

In this menu, you can check the information on the system including the name of the SSC21WEB Server, its model name and the version of the model and change the name of the SSC21WEB Server.

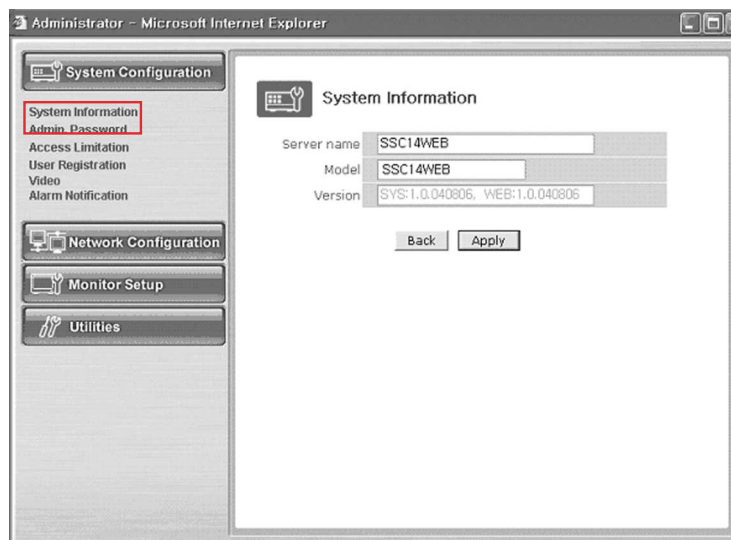

- Menu Configuration

Server Name	Type in the name of the SSC21WEB Server. * Server's name should be composed of 19 or less numerals or English alphabets. It cannot start with a numeral and should start with an English alphabet. White characters including a space, tab, and a special letter cannot be used.
Model	SSC21WEB Server product model name SSC21WEB * This part is only for reading, cannot be changed.
Version	SSC21WEB Server product's version * This part is only for reading, cannot be changed.

After completing setting, click Apply button.

If you click the back button, initial values are typed in all fields.

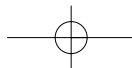

User Guide

2. Admin Password

In this menu, the password of the administrator (root) can be changed.



- Menu Configuration

Administrator's ID	Administrator's ID is always "root".
Old Password	The initial password is "root".
New Password	Type the password you want to change into. * The password should be composed of 4-8 digit numerals or alphabets.
Confirm Password	Type again the password you want to change into.

After completing setting, click Apply button.

If you click the back button, initial values are typed in all fields..

After clicking the apply button, the new password will be applied.

Then the connection of SSC21WEB Server, which was connected by using the existing password, to the Web Page will be cut off because the new password is now applied.

The user needs to log in again by using the new password.

3. Access Configuration

This menu is to set the targets the SSC21WEB Server can have an access to.

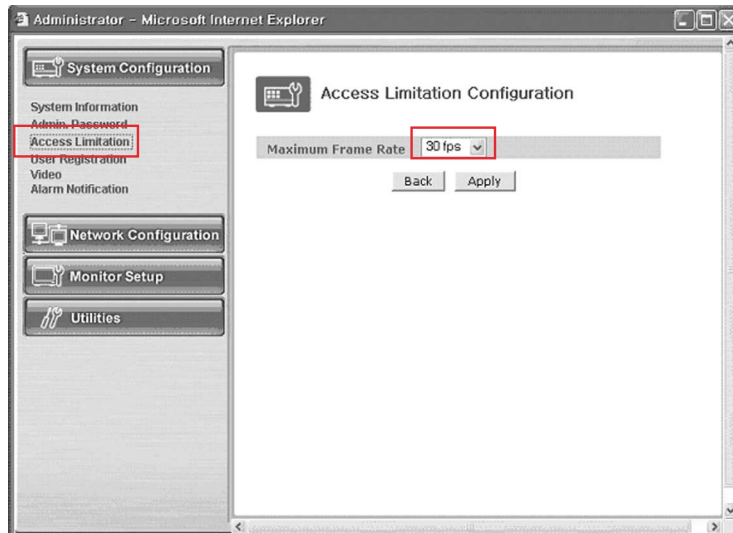

- Menu Configuration

<p>Access Limitation Configuration</p>	<p>This is to limit the maximum frame speed when the users, who are registered in the system, join and see the images.</p> <p>The users, who join in the system after this setting, will be connected at the limited speed.</p> <p>The access speed can be limited on the Local Network depending on the forwarding state of the network. (30/15/10/5/2/1 ips)</p>
--	--

After completing setting, click Apply button.

If you click the back button, initial values are typed in all fields.

User Guide

4. User Registration

This is a user control menu to register, change, or delete the users who can use the SSC21WEB Server.

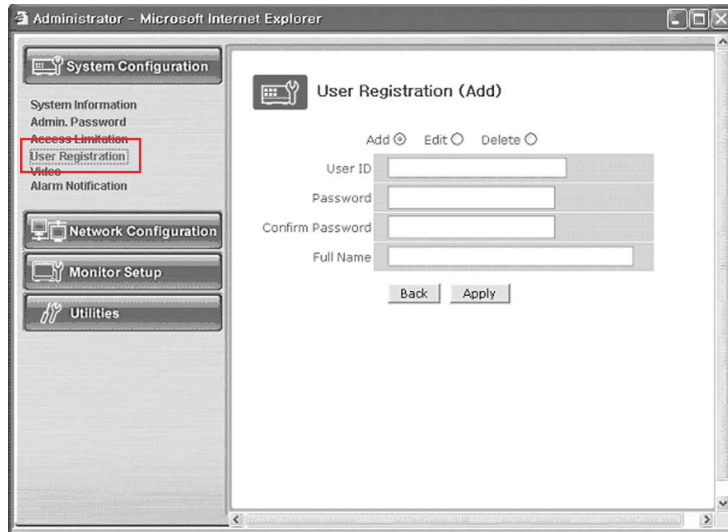

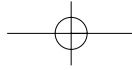

- Menu Configuration

User ID	Decide the ID of the person you want to register.
Password	Decide the password of the person you want to register.
Confirm Password	Type again the password of the person you want to register.
Full Name	Type in the name of the person you want to register.
Add	<p>This is a menu to register a user. It is to fix the user's ID, Password, name, and the authority of the user how far he/she can use the system.</p> <ul style="list-style-type: none"> - Type in the user's ID in the User ID column. - Type in a password in the Password and Confirm columns. The user's ID and the password should be composed of 31 or less numerals or letters. - Type in the name of the user in Full Name column.
Edit	<p>On this menu, you can change the existing password, name, and access right of the user.</p> <p>The user's ID cannot be changed. The configuration of the menu is same as Add, however you should select the user's ID on this menu.</p> <ul style="list-style-type: none"> - Choose Edit menu. - Click "Select User ID" in User ID and click the user's ID you want to edit. - Modify the password, name, and access right of the user and click Apply button to apply the modified items.
Delete	<p>This menu is to delete the registered user.</p> <ul style="list-style-type: none"> - Choose Delete menu. - Choose the user's ID you want to delete in the box. - Click Delete button to delete the ID. - Click Save button to complete registration.

After completing setting, click Apply button.

If you click the back button, initial values are typed in all fields.

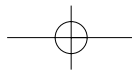

User Guide

5. Video Configuration

This is to set the data to be added in the video data and set an environment for each channel.

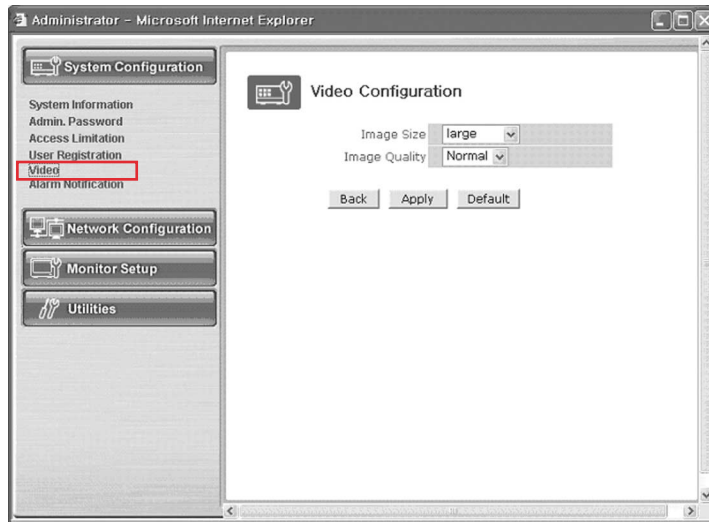

- Menu Configuration

Image Size	This is to choose the size of the image of video data. You can choose between 2 kinds of size (Small / large).
Image Quality	This is to choose the quality of the image. You can choose between 3 levels (High, Normal, Low).

After completing setting, click Apply button.

If you click the default button, initial values are typed in all fields.

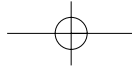

6. Alarm Notification

This notifies the registered users of an alarm arising situation through e-mails.

At this time, maximum 5 M-JPEG pictures, which were stored, can be sent together.

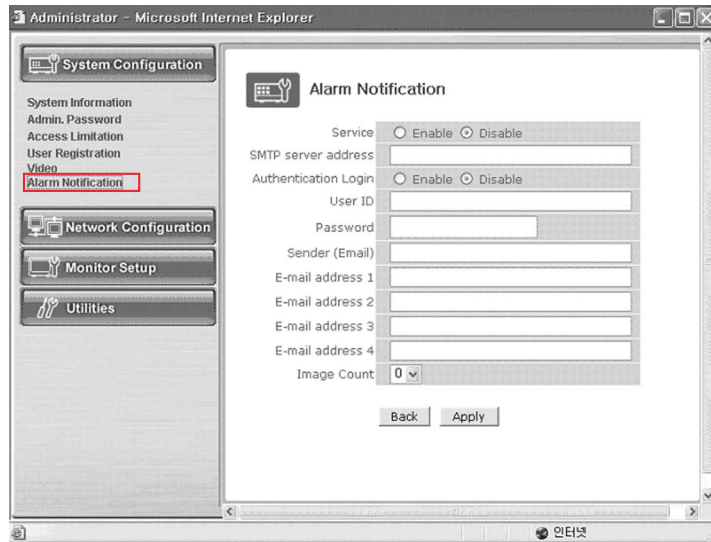

- Menu Configuration

Service	Choose if you want to send the ALARM notifying E-MAIL.
SMTP server address	SMTP server of the ISP that provides SSC21WEB with services. ISP's confirmation required.
Authentication Login	Choose if you want to log in the SMTP of the ISP providing SSC21WEB with services.
User ID	ID for the SMTP server of the ISP that provides SSC21WEB with services.
Password	Password for the SMTP server of the ISP that provides SSC21WEB with services.
Sender (E-mail)	Register the E-mail of ADMINISTRATION of SSC21WEB
E-mail address 1 ~4	E-mail addresses you want to send the alarm notification to.
Image count	M-JPEG images to send. Up to 5 pictures can be sent at 0.5-second intervals. * Some SMTP servers may not support M-JPEG forwarding. Set this function after checking the SMTP server.

After completing setting, click Apply button.

If you click the back button, initial values are typed in all fields.

On this menu, you can fix the general environment related to the network of the SSC21WEB Server and check the present status of it.

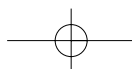

User Guide

EX) When user who has an e-mail address (SSC21WEB@yahoo.com) and password(123456) in YAHOO sets "Alarm Notification" in order to send a mail to test1@yahoo.com...

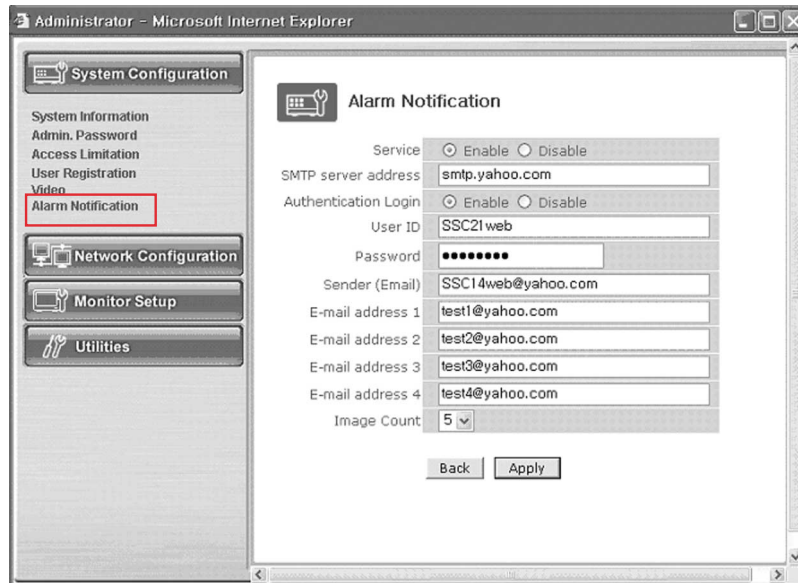

After completing setting, click Apply button.

If you click the back button, initial values are typed in all fields.

The image transfer is not supported in all SMTP servers. Check the J-PEG image transfer in your mail account.

In the event of Alarm, please use PLAYER to catch normal JPEG images.

Otherwise, the image size will be reduced to a half JPEG size.

Refer to Eng-46 "How to play" for the detailed usage of PLAYER.

3-8-3) Network Configuration Menu.

1. Network Configuration

On this menu, you can fix the general environment related to the network of the SSC21WEB Server and check the present status of it.

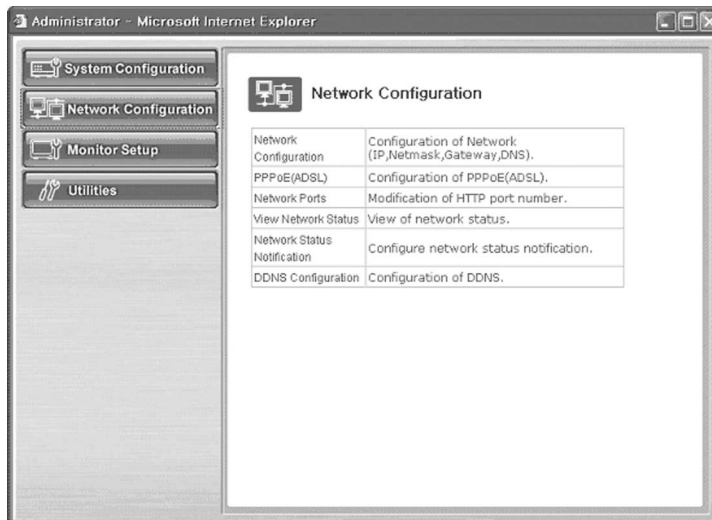

- Menu Configuration

Network Configuration	Set "Static IP" or "DHCP".
PPPoE(ADSL)	Set PPPoE (ADSL).
Network Ports	Set "Network Port".
View Network Status	Modification of HTTP and other application network port numbers.
Network Status Notify	View of network status.
DDNS Configuration	DDNS Configure

- 1) Fix the IP address of the SSC21WEB Server, NetMask, GateWay, DNS1, DNS2, etc.
- 2) NetMask : This is a column of letters of only 0 or 1 to leave the address of the host computer alone among the IP Addresses. (Example : "255.255.255.0" is used for a C-Class serve net capable of maximum 255 host computers. In this line, ".0" clarify the address of a certain host computer.)
- 3) GateWay : This is a network point that plays a role as an entrance to other networks.
- 4) DNS (Domain Name Service) : A service to convert a Domain Name (ex. www.yahoo.com) into an IP address (ex. 216.109.127.28). The SSC21WEB Server uses this service to join the FTP server or other webs by the Domain Name.

Eng-63

User Guide

1-1. Network Configuration : **Static IP**/ DHCP Client

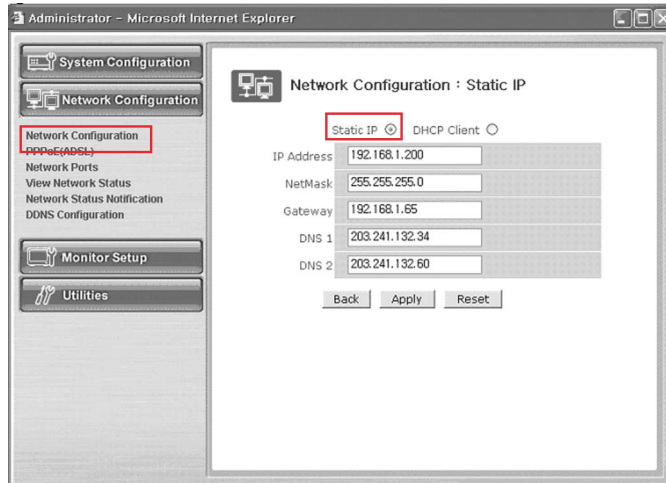

- 1) If the IP of the SSC21WEB Server is Static : Choose "Static IP".
- 2) Type in the IP Address you want to assign to the SSC21WEB Server, NetMask, GateWay, DNS1, and DNS2 addresses.

1-2. Network Configuration : **Static IP** / **DHCP Client**

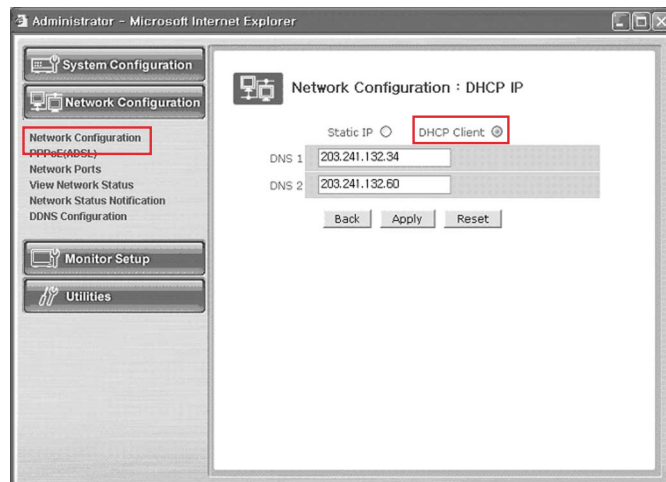

- 1) If the IP of the SSC21WEB Server is DHCP : Choose "DHCP Client".
- 2) Type in the addresses of DNS 1 and DNS 2.

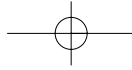

3) Click Apply button to apply the settings.

If you click Reset button, the latest setting will be applied again.

Click Back button if you don't want to apply the setting.

4) Open your Internet Explorer web browser, type in the following in the URL window and press ENTER.

`http://sff0000.websamsung.net`

Where ff0000 is the MAC address of your SSC21WEB in this example.

If your SSC21WEB's MAC address is ff0001, then type in ff0001 instead of f0000.

At this time, you should add "s" in front of "mac address".

*** Note : MAC Address.**

Locate the MAC Address of the SSC21WEB (each SSC21WEB has its own unique MAC address). It can be checked in "7.NETWORK SETUP" of SETUP MENU.

MENU / SETUP MENU / 7.NETWORK SETUP

It is the last 6 digits as shown below.

06/01/03	13:14:00
NETWORK ACCESS	
NETWORK STATUS	
IP_ADDR	192.168.1.200
GATEWAY	192.168.1.65
SUBNETMASK	255.255.255.0
DNS 1	168.126.63.001
DNS 2	168.126.63.002
MAC_ADDR	00:30:6f:ff00:00

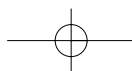

User Guide

2. PPPoE (ADSL) for Eth0

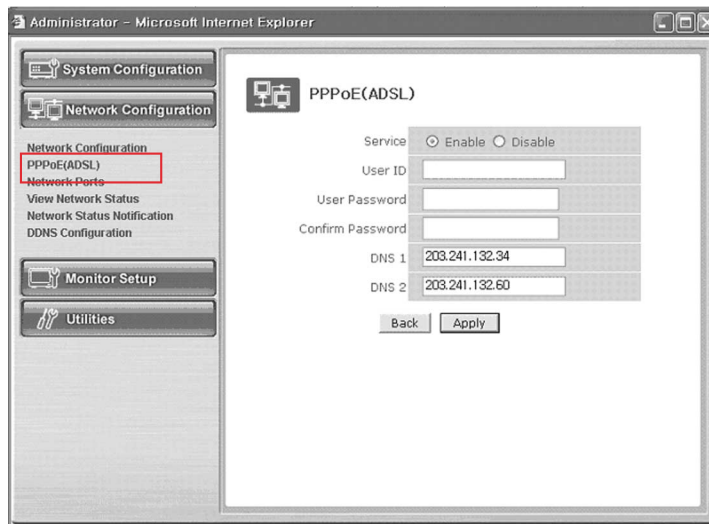

- 1) Service : Decide if you want to try PPPoE Connection or not.
- 2) User ID : User's ID that is registered in th ISP.
- 3) User Password : User's password that is registered in the ISP.
- 4) Confirm Password : Confirm the password.
- 5) DNS (Domain Name Service) : Service to convert a Domain Name (ex. www.yahoo.com) into an IP address (ex. 216.109.127.28).

The SSC21WEB Server uses this service to join the FTP server or other webs by the Domain Name.

ADSL service supports only PPPoE (Point to Point over the Ethernet).

DNS is a default value, so it does not need to change except a special case.

* **Note** : When connecting ADSL, ID & PASSWORD shall be limited within 40 characters.

3. Network Ports Configuration

It sets the HTTP Port number to use when the SSC21WEB Server communicates with a Client PC.

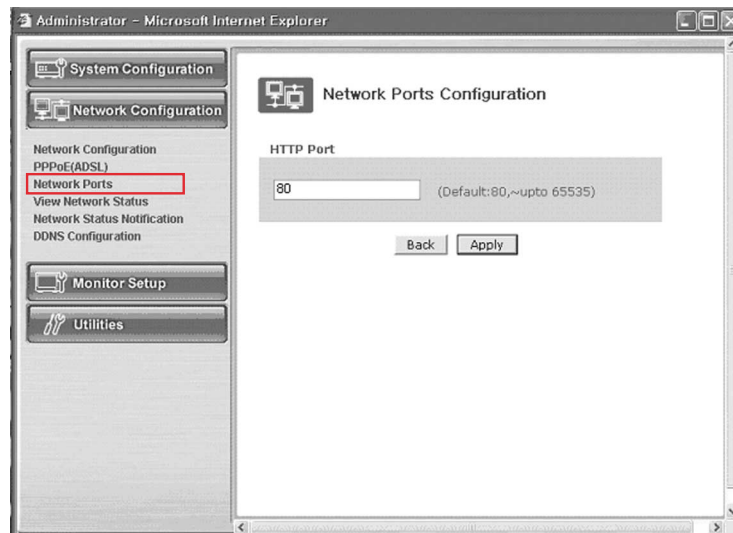

The present SSC21WEB Server uses HTTP Port (80).

- HTTP Port

- 1) This is the port the Client PC uses to connect to the web page of the SSC21WEB Server.
Depending on the environment of the network, its value can be varied.
- 2) The fault values is 80 and it can be assigned up to 65535 maximum.
* If you change the value of the HTTP Port, you should type in the new one with the address of the SSC21WEB Server in the address window of the web browser.
(Ex. If the IP address of the SSC21WEB Server is 192.168.1.100 and the HTTP Port : 8080, <http://192.168.1.100:8080>.)
- 3) Click Apply button to apply the present setting.

CAUTION

Set the port be used when connecting to SSC21WEB in internet Explorer.

The port setting is used for various network configuration when avoiding the network where firewall constitutes or a particular port Etc.

User Guide

4. View Network Status

This is a menu to see the general status of the network setting of the SSC21WEB Server.

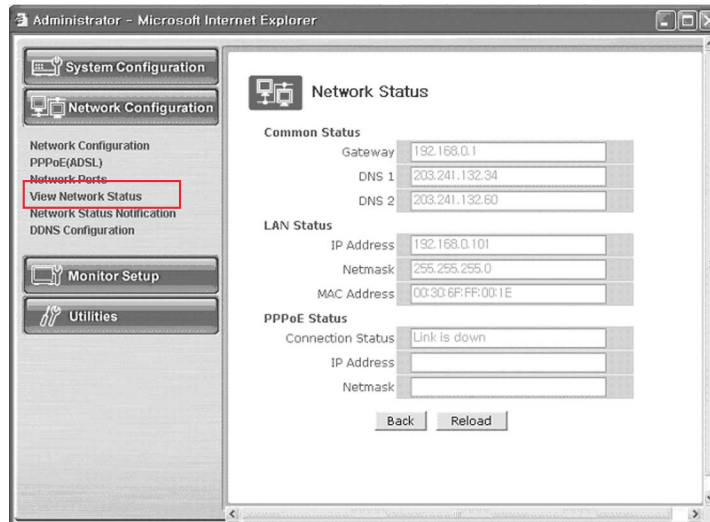

- Menu Configuration

Common Status	It is to check the status of the Gateway, DNS 1, and DNS 2.
LAN Status	It is to check the status of the STATIC IP Address, Netmask, and MAC Address.
PPPoE Status	<p>If the PPPoE service is in the connection status, "Link is up". At this time, the service IP and NETMASK can be also checked.</p> <p>If the PPPoE service is not in the connection status, "Link is down".</p> <p>The existing setting will be recalled if you press Reload button.</p>

5. Network Status Notification

When there is a change in the setting status of the SSC21WEB Server, it sends e-mails to the people who want it. Set Mail Notification to "Enable" to send the network setting status of the SSC21WEB Server to the specified e-mail addresses in the cases as follows.

There are some conditions required for this setting.

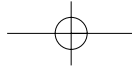

- 1) DHCP Client has been set in “Network Configuration” menu and an IP has been assigned from the actual DHCP Server to make communication possible.
- 2) PPP Client has been set in “PPPoE” menu and communication has become possible through the connection with ISP or PPP Server.

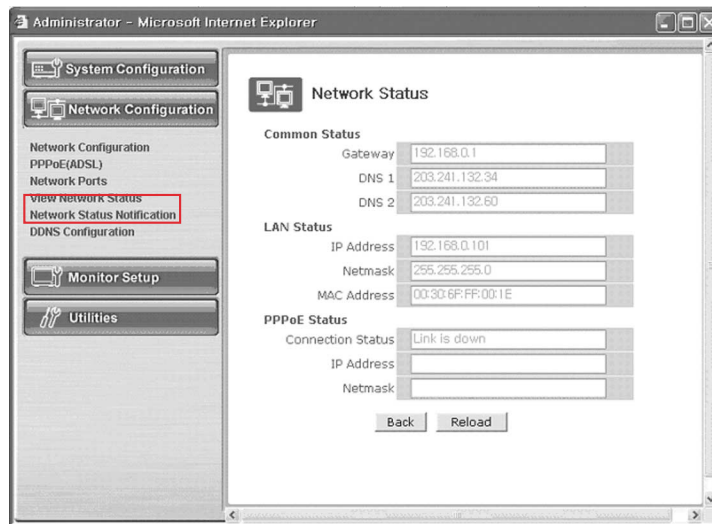

- Menu Configuration

Mail Notification	E-mail forwarding or not. Enable : Forward E-mails. Disable : Doesn't forward E-mails.
SMTP Server	Type in the address of the server that provides e-mail relay function.
Authentication Login	Shows if the ISP has an authentication for the use of SMTP.
User ID	ID for Authentication Login
Password	Password for Authentication Login
Sender(Email Address)	Type in the addresses of the sender.
Recipient's Email Address	Type in the addresses of the recipients. (3 addresses maximum.)

Network Status Notify Configuration

click “Network Status Notify” in the Network Configuration group.

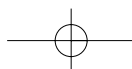

User Guide

Choose to use the Mail Notification function or not. Choose "Enable" if you want to notify the network status of the SSC21WEB Server to the people who want through e-mails.

Type the address of the SMTP Server.

*** SMTP Server plays a part as a relay that receives the mail of the user and delivers it to the receiver.**

Set "Authentication Login" to Enable and type in the ID and password assigned from the SMTP server.

Type the e-mail address of the person who receives the E-mail. Maximum 3 people can receive the mail.

Type the message you want to add in "User Defined Message".

After completing setting, click Apply button.

If you click the reset button, it will return to the latest setting.

EX) When user who has an e-mail address (SSC21WEB@yahoo.com) and password(123456) in YAHOO sets "Alarm Notification" in order to send a mail to test1@yahoo.com...

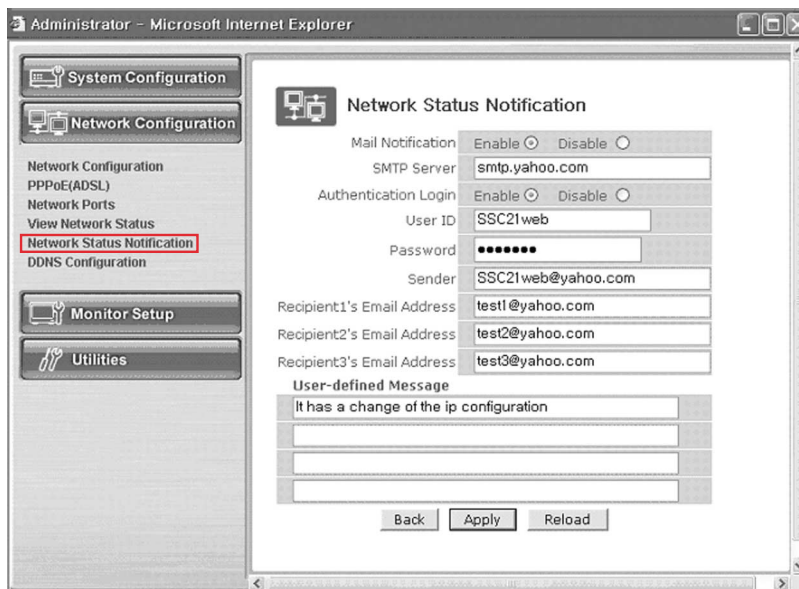

6. DDNS CONFIGURATION

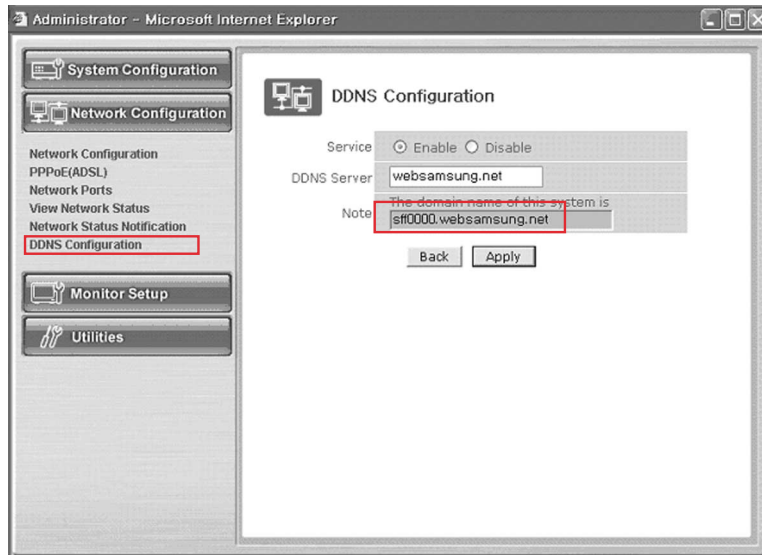

- Menu Configuration

Server	Select Enable or Disable
DDNS Server	Websamsung.net
Note	The domain name of this system is sff0000.websamsung.net

CAUTION

In case of a configuration using DHCP, as the connection to SSC21WEB is made using domain names (EX : <http://sff0000.websamsung.net>) that are automatically registered in our DDNS server, IP address, Subnet Mask and Gateway that are in the network tab of Admin Mode are not necessarily to be inputted.

The proper domain names of SSC21WEB are automatically registered to DDNS server installed in our company in case of DHCP cable modem connection.

User Guide

3-8-4) Monitor Set up

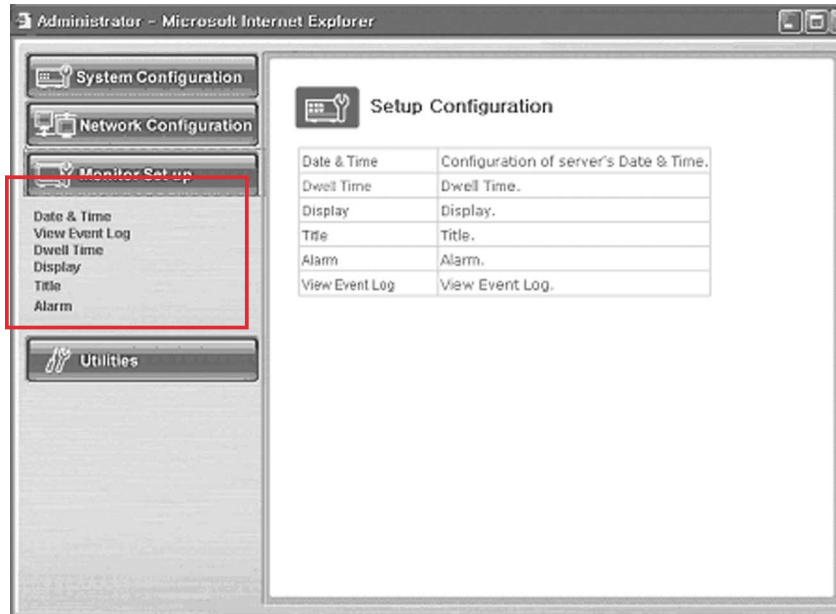

- Menu Configuration

Please refer to the CHAPTER3 of the user's manual.

Date & Time	Set the display data format and current time.
View Event Log	Display the time and data of camera event and type of event
Dwell Time	Displays each picture for pre-set time and automatically Switches it to the next picture at SEQUENTIAL DISPLAY MODE.
Display	Allows users to select the color and ON/OFF of borderline at QUAD DISPLAY
Title	Set the title of each camera at your discretion
Alarm	Allows users to set the ALARM MODE for each camera

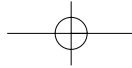

3-8-5) Utilities

This menu is for the flash memory's update, rebooting, restoring to the basics, and system upgrade.

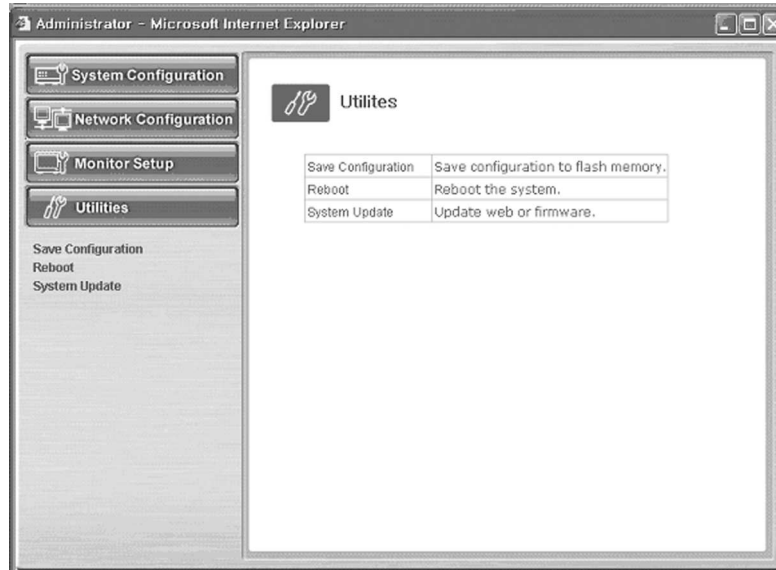

- Menu Configuration

Save Configuration	Save Configuration is required to save all of new configuration in the system. Otherwise, no new configuration will be saved effective.
Reboot	System reboot is highly and strongly recommended to applied all new configurations properly to the SSC21WEB system
System Update	System Update

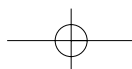

User Guide

1. Save Configuration

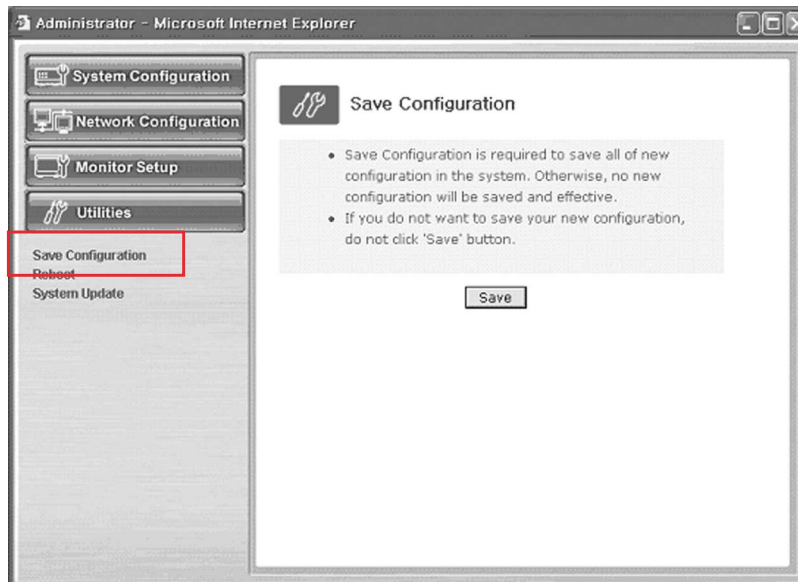

This menu is to save all of the present setting in the Flash Memory.

If you changed any of the setting for the SSC21WEB, it is recommended that you save it in the Flash Memory in this menu.

2. Reboot

This menu is for the rebooting of the system. It is better to reboot the system if you change the setting and update the flash.

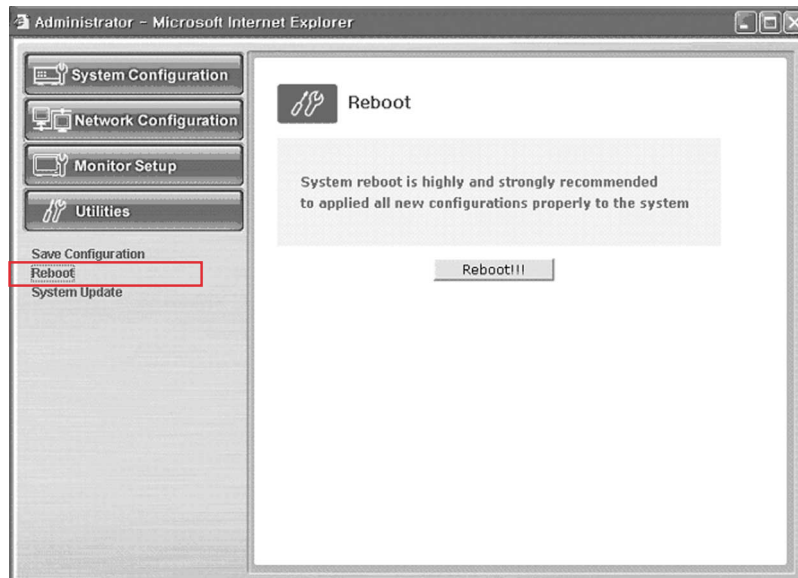

1. Click "Reboot" in the utilities group.
2. Click "Reboot!!!".

User Guide

4. System Update

This menu is to update the inner programs and data of the SSC21WEB Server. They are recorded in the Flash Memory and composed of 4 parts called Kernel Image, Ram disk Image, System Image, and Web Image respectively.

Each image file should be stored in the user's PC for update.

Depending on the range you want to update, press the start button properly.

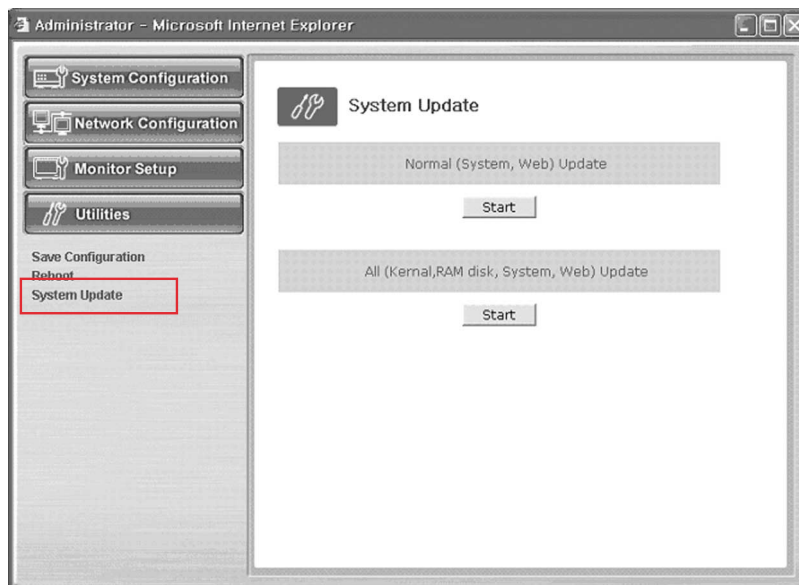

Normal (System and Web) Update	Update only the System Web.
All (Kernel, RAM disk, System, Web) Update	Update all 4 images of Kernel, RAM Disk, System, and Web.

4-1. Normal (System and Web) Update

When you click the start button located in the right side of "Normal (System and Web) Update", a window will appear to ask if you want to update.

Click "Cancel" to stop updating. Click "OK" to proceed updating.

Other processes are same as the process of "All Update". (Excluding the update of Kernel and RAM disk)

After completing the update, click the reboot button to reboot the system.

4-2. All (kernel, RAM disk, System, Web) Update

When you click the start button located in the right side of “All (Kernel, RAM disk, System, Web) Update”, a window will appear to ask if you want to update.

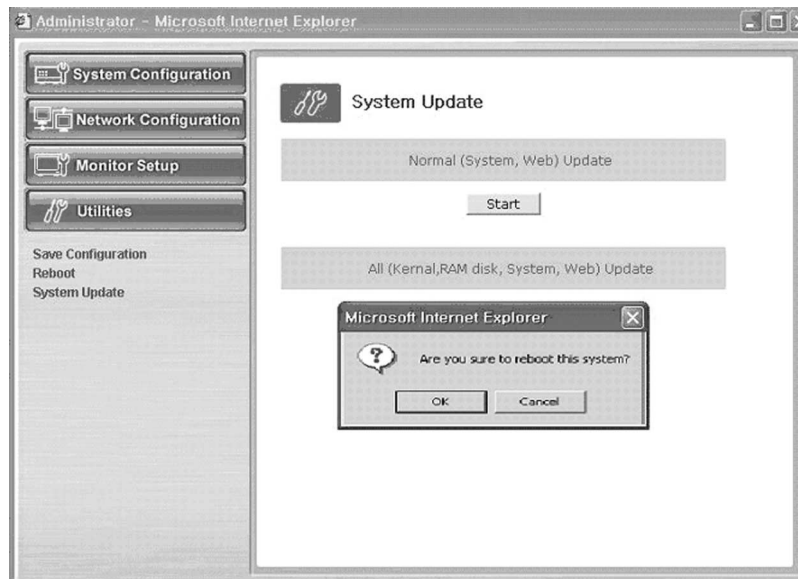

Click “Cancel” to stop updating.

1. “OK” to proceed updating.

2. A pop-up window will appear. Choose “Zimage” in the browse.

User Guide

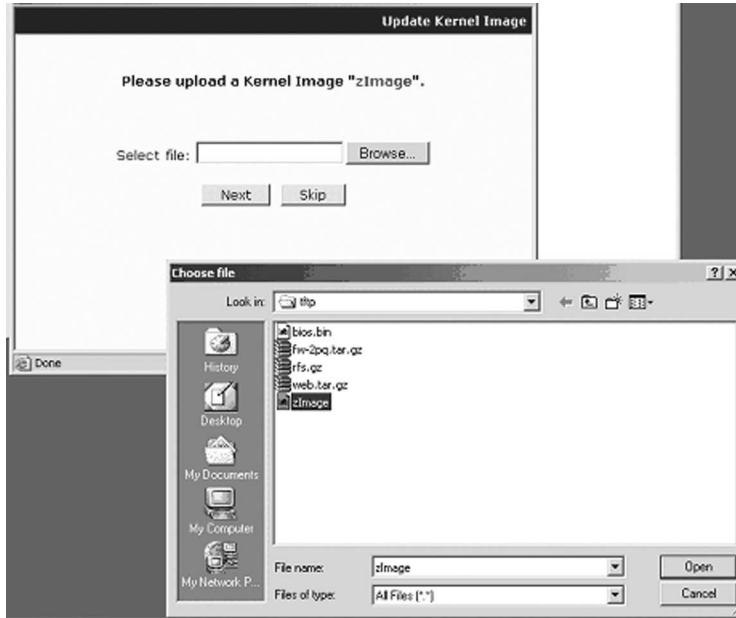

3. Click "Next" button to move to the next stage.

Click "Skip" button to move to the next stage without Kernel Image's update.

Click "Next" button and a window will appear to check the name and size of the file.

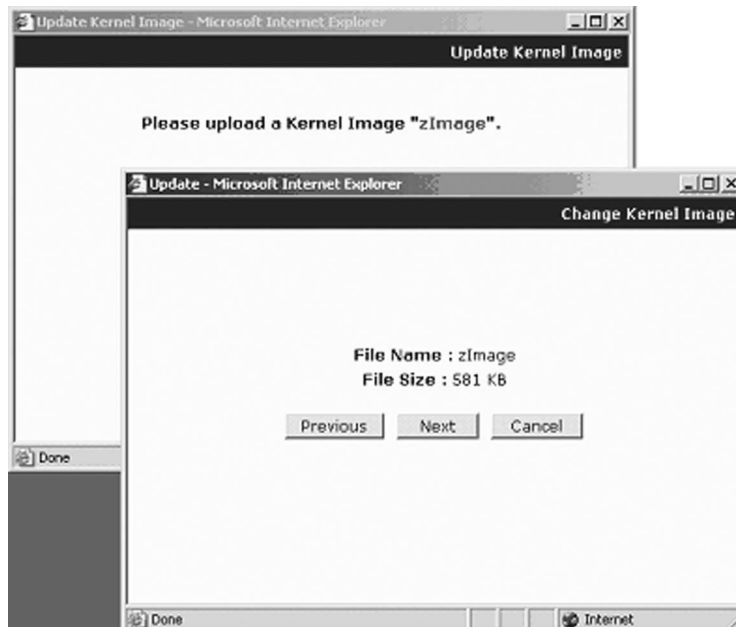

- Click "Previous" button to go back to the previous stage.
Click the next button to execute update of the program and move to the next stage.
Click the cancel button to stop the update process.
4. In the next stage, a pop-up window will appear for the file searching for the RAM Disk Update.
Choose "rfs.gz" in the browse.

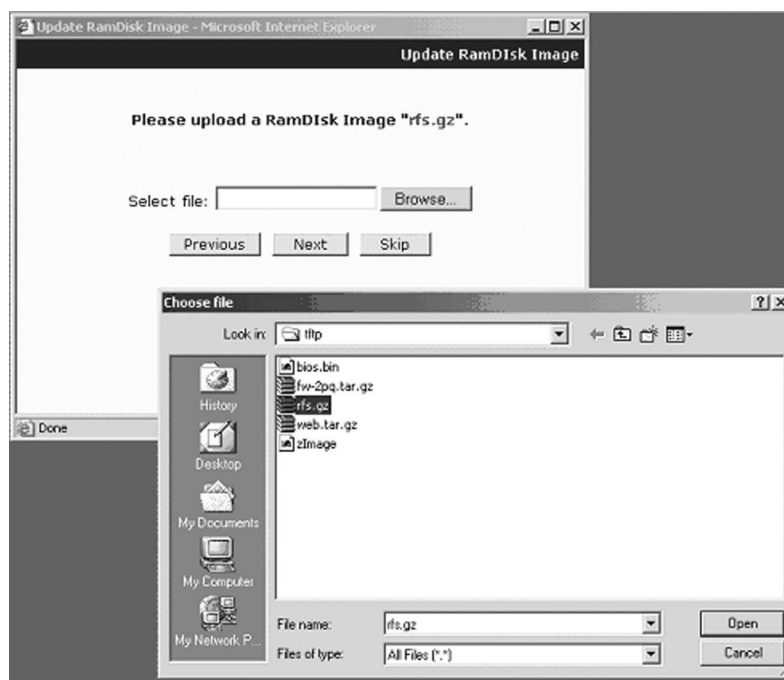

User Guide

5. Click "Next" button to move to the next stage.

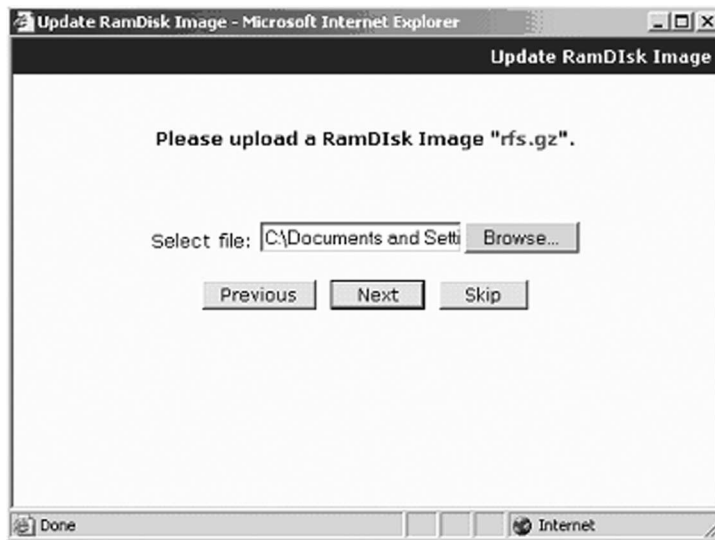

Click "Skip" button to move to the next stage without Kernel Image's update.

Click "Next" button and a window will appear to check the name and size of the file.

Click "Previous" button to go back to the previous stage.

Click the next button to execute update of the program and move to the next stage.

Click the cancel button to stop the update process.

6. In the next stage, a pop-up window will appear for the file searching process for the System Image Update.
Choose "Fw_2pq.tar.gz" in the browse.

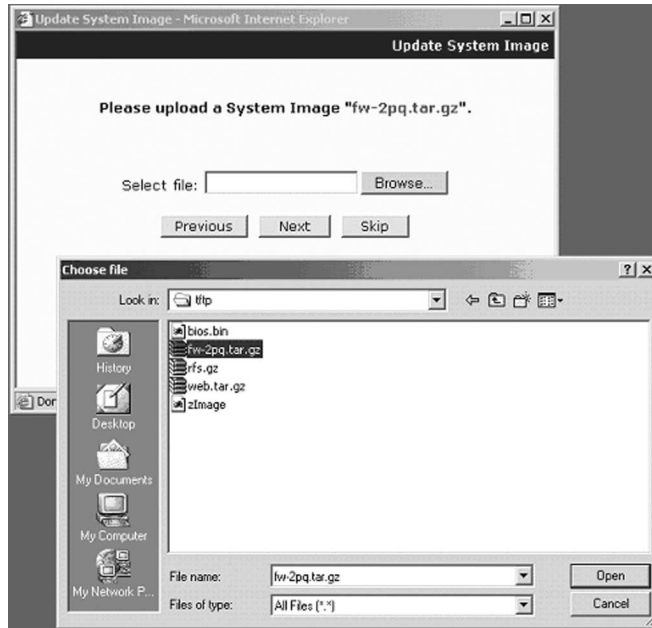

7. Click "Next" button to move to the next stage.

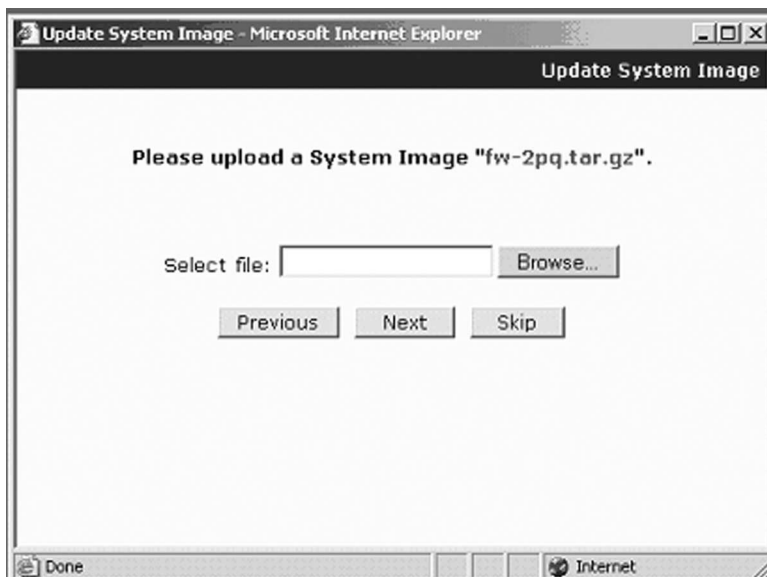

Eng-81

User Guide

Click "Skip" button to move to the next stage without kernel Image's update.

Click "Next" button and a window will appear to check the name and size of the file.

Click "Previous" button to go back to the previous stage.

Click the next button to execute update of the program and move to the next stage.

Click the cancel button to stop the update process.

8. In the next stage, a pop-up window will appear for the file searching process for the System Image Update. Choose "web.tar.gz" in the browse.



9. Click "Next" button to move to the next stage.

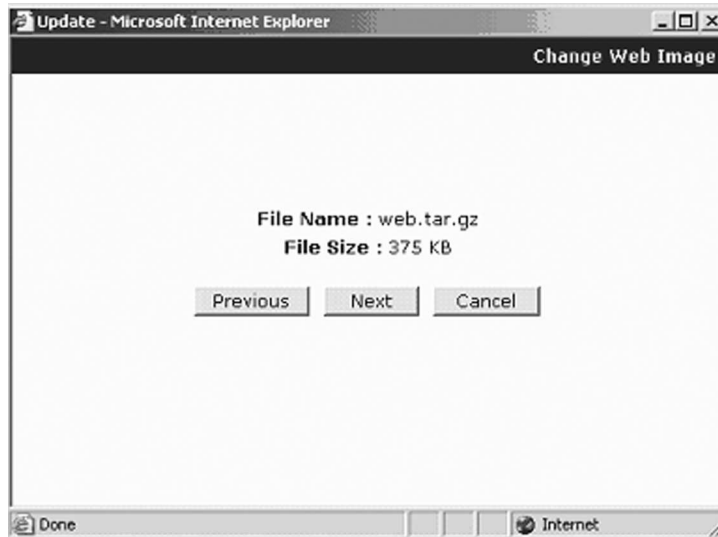

Click "Skip" button to move to the next stage without Kernel Image's update.

Click "Next" button and a window will appear to check the name and size of the file.

Click "Previous" button to go back to the previous stage.

Click the next button to execute update of the program and move to the next stage.

Click the cancel button to stop the update process.

User Guide

10. A window will appear for rebooting after completing all the update processes.

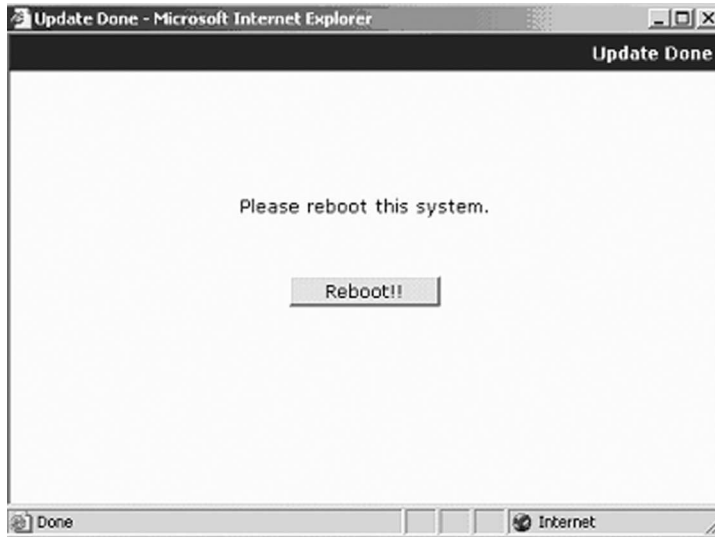

Click the reboot button and press the confirmation button to reboot the system.

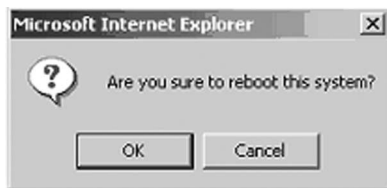

11. Close your web browser and wait for about a minute before you log in again

Files relate to the update of SSC21WEB

Kernel Image	zimage
RAM Disk Image	rfs.gz
System Image	Fw_2pq.tar.gz
Web page Image	web.tar.gz

The window shown as above may not appear if there is a pop-up breaker installed in the user's PC. If you update system on a web page, you should stop the pop-up breaker to proceed.

* **Note** : Download a picture at <http://www.securitysamsung.com>
Refer to Appendix A (page 96).

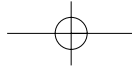

3-9) VIEW EVENT LOG MENU function and setting method

- **Function:** Displays the time and date of camera event and type of event.
- **Setting method:** Move to #7. VIEW EVENT LOG MENU by using ◀ENTER▶ SWITCH at SETUP MENU, then press the ENTER SWITCH to display the OSD as shown in the figure below. (The figure shows the initial setting status.)

06/01/03		13:14:00		
NO	CH	MM/DD/YY	HH:MM:SS	EVT
01	07	02/10/03	10:00:30	A
02	01	02/11/03	11:22:00	L
03	01	06/01/03	12:08:01	-
04	01	06/01/03	13:01:03	-
05	01	-/-/-	-:-:-	-
06	01	-/-/-	-:-:-	-
07	01	-/-/-	-:-:-	-
08	01	-/-/-	-:-:-	-

Sequence of event happening → (01)

Camera No. that event happened. → (07)

Date of event happening → (02/10/03)

Time of event happening → (10:00:30)

Type of event happening
L : LOSS
A : ALARM

An event which occurred most recently is recorded with first priority, then users can move to the next page by using ◀ENTER▶ SWITCH. A Total of 64 events can be listed.

* **Note :** IF you press the FREEZE key and the SEQUENCE key at the same time, all event lists will be erased.

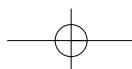

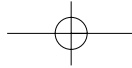

Chapter 4: DISPLAY MODE setting method

4-1) SINGLE SCREEN DISPLAY

Initial display mode of monitor is QUAD A. In case users want to see the camera image at full mode, select a target camera by turning ◀ENTER▶ SWITCH left and right. After that, press the ENTER SWITCH and selected camera image will be displayed at full screen. If users turn the ◀ENTER▶ SWITCH left / right at SINGLE DISPLAY MODE at this time, they can see another camera image at full screen. For example, when users want to see CH1 at FULL MODE after SINGLE -displaying CH2 at QUAD A, please follow the instructions below.

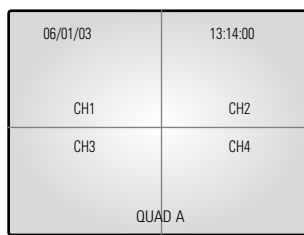

INITIAL DISPLAY STATUS

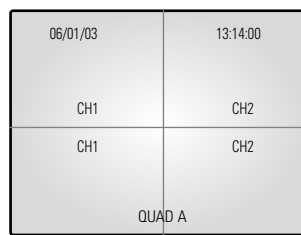

Select **CH2** by turning ◀ENTER▶ SWITCH

Press ◀ENTER▶ SWITCH after selecting **CH2** ↓

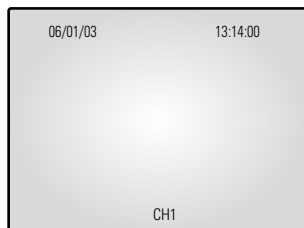

FULL SCREEN DISPLAY of **CH1**



Display **CH1** by turning ◀ENTER▶ SWITCH

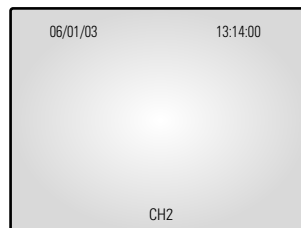

FULL SCREEN DISPLAY of **CH2**

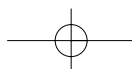

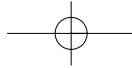

4-2) QUAD MODE DISPLAY

Users can switch SINGLE DISPLAY MODE and SEQUENTIAL DISPLAY MODE to QUAD DISPLAY MODE, or QUAD A (QUAD B) to QUAD B (QUAD A), or PIP MODE to QUAD MODE, press the QUAD/PAGE KEY.

* At QUAD MODE display from SINGLE MODE or SEQUENCE MODE,

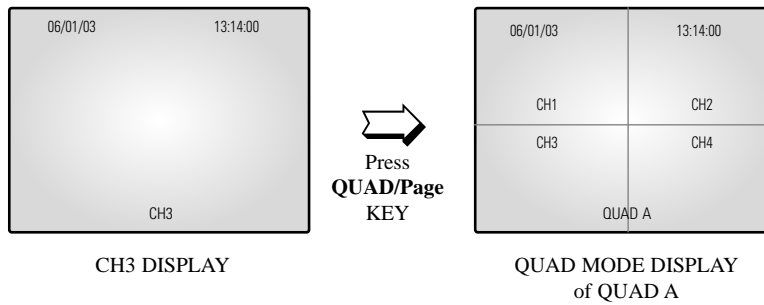

* At QUAD B(QUAD A) display from QUAD A(QUAD B),

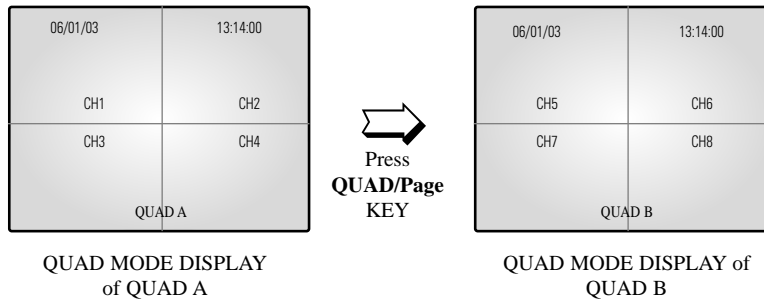

* At QUAD B(QUAD A) display from PIP MODE,

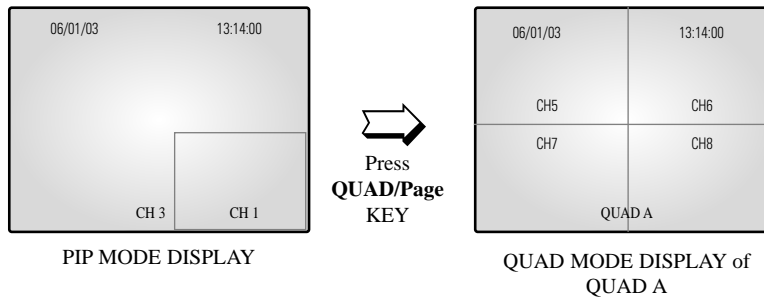

Eng-87

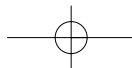

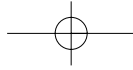

User Guide

4-3) AUTO SEQUENTIAL DISPLAY MODE

Pressing on the SEQUENCE KEY on the front allows screen to automatically switch to SINGLE MODE full screen or QUAD MODE. ('no-signal' channels will be skipped while single screen is auto-switching.)

If the DWELL TIME SETTING of SETUP MENU is set to 3 seconds and the SEQUENCE KEY is pressed at this time, the operation will be carried out as follows.

* SINGLE MODE SEQUENCE DISPLAY

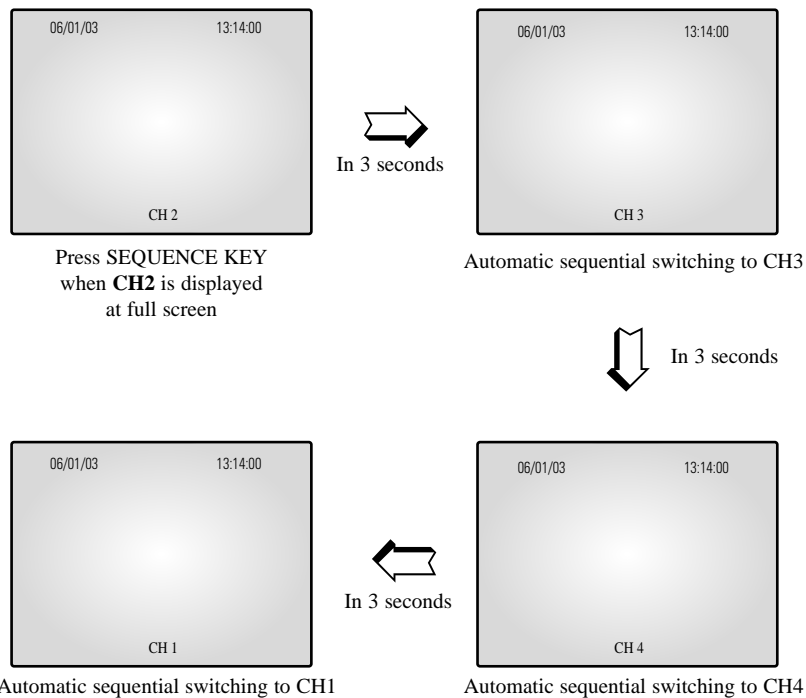

* QUAD MODE SEQUENCE DISPLAY

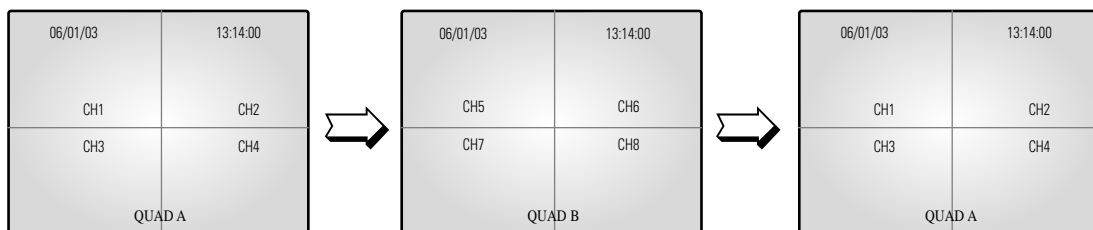

Eng-88

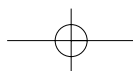

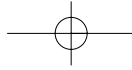

4-4) PIP MODE DISPLAY

Can be used to see PIP screen in Single screen mode.

If you press the **◀ENTER▶** on PIP screen ,the main screen will change. If you press the **◀ENTER▶** to the left and right,the main screen can be transferred to another channel.

Sub-screen location can be selected on DISPLAY MENU in SETUP MENU.

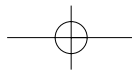
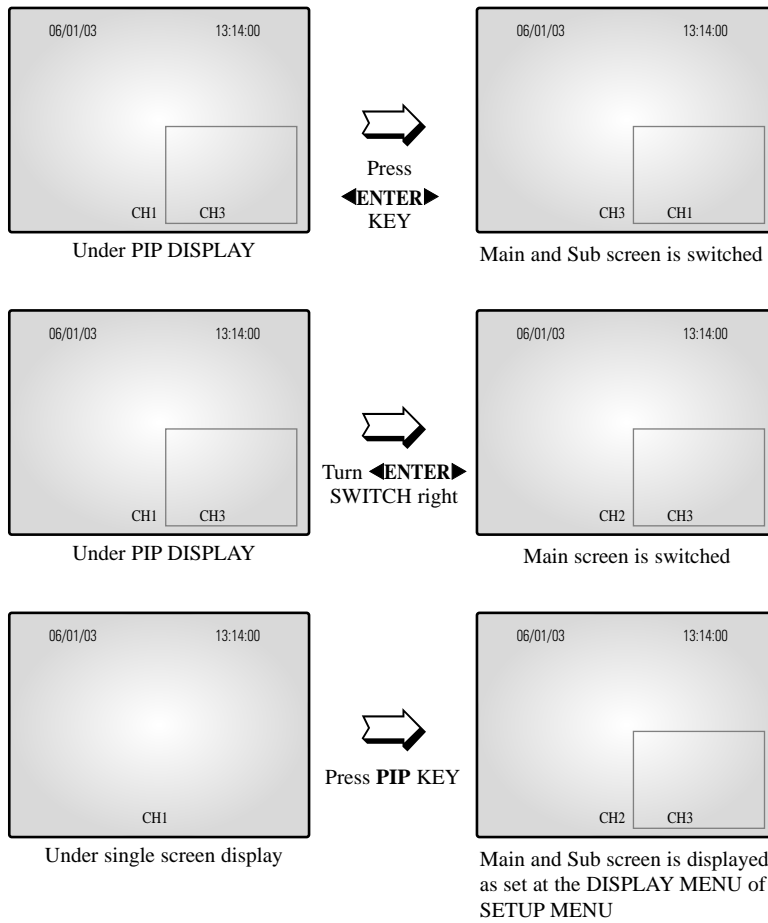

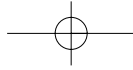

User Guide

4-5) ZOOM MODE DISPLAY

When users want to see zoomed image of a specific area of the display, press the ZOOM KEY in the front to display zoom selection area. Select zoom target area by turning ◀ENTER▶ SWITCH left and right, and press the ENTER SWITCH, then, the selected area will be displayed at full single mode with zoomed area doubled. At zoom function operation at SINGLE DISPLAY MODE (CH2), the operation will be carried out as shown in figure below. (Zoom selection areas at SINGLE DISPLAY MODE are nine.)

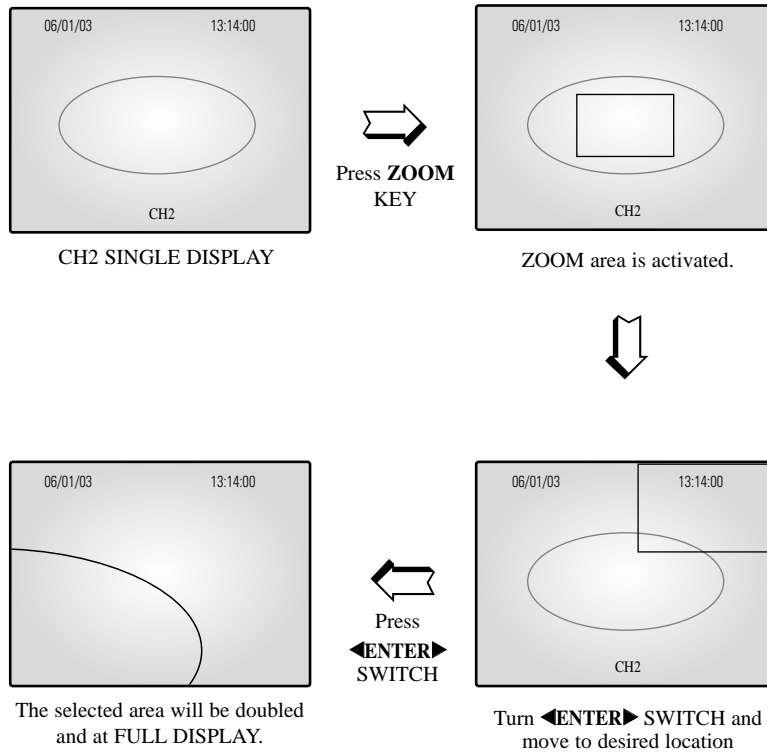

Eng-90

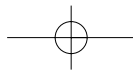

Chapter 5: Each product feature

SOD14C : Standard Camera

Model Name	SOD14C
Broadcasting System	NTSC STANDARD
Imaging Device	1/4 "SUPER HAD IT CCD
Effective Pixels S	510(H) x 492(V)
Synchronization	Internal
Resolution	H :330 TV Lines, V: 350 TV Lines
Signal Output	VBS 1.0Vp-p(75ohms composite)
S/N Ratio	≤ 48 dB
Minimum Scene Illumination	2lux(F2.0, 50 IRE)
Gamma Correction	0.45
Lens	Focal Length (f) : 3.8mm, Aperture Ratio (F) : 2.0
Auto Exposure	Electronic Shutter Iris
Audio	-40dB Condenser Microphone Inclusion
I/O Connectors	Modular jack
Operating Temperature	-10 ~ +50 °CC
Power Source	DC 12V
Power Consumption	Approx. 2W
Dimensions	57(W) x 47.2(H) x 100.5(L)
Weight	150g

User Guide

OBSERVATION MONITOR (SSC21WEB)

Video Input	<ul style="list-style-type: none"> CAMERA 8 Input: 1.0Vp-p(CVBS), 75Ω (vertical) VCR 1 Input (to Video Out of VCR) : 1.0Vp-p, 75Ω (vertical)
Video Output	<ul style="list-style-type: none"> BNC 4 Output: 1.0 Vp-p, 75Ω (vertical), S-Jack Type, CVBS VCR 1 Output: 1.0 Vp-p, 75Ω (vertical), S-Jack Type, CVBS
Audio Input	<ul style="list-style-type: none"> CAMERA 8 Input: VCR 1 Input (to Audio Out of VCR) : S-Jack Type
Audio Output	<ul style="list-style-type: none"> CAMERA 8 Input: VCR 1 Output: S-Jack Type
Alarm/Motion Features: Connected to Alarm Box/Camera	<p>A/O (HOT, COLD) : Relay Active</p> <p>A/R (Alarm Reset) : Open Collector "L" Level, Pulse Width =150ms or above</p> <p>Alarm Hold Time : Select 5 sec, 15 sec, 30 sec, 1 min, 3 min, 5 min, 10 min, 20 min, 30 min..</p>
Sequence	Select between 01 sec to 30 sec.
Event List	(max) 64 case
Display mode	Single mode, Quad A mode, Quad B mode, PIP, Sequence Freeze, Zoom(X2)
Horizontal Resolution	350 TV Lines or more (Live Mode Full Screen)
Operation Temperature	0 °C ~ 40 °C
CRT	21" FLAT CRT
Dimension (W x D x H (mm))	(MONITOR)520 x 509 x 486, (PACKING)655 x 640 x 771
Weight	(MONITOR) 28.0Kg, (PACKING) 39.5Kg
Power consumption	110W
Video system	NTSC VIDEO SYSTEM
High Voltage (KV)	28 ±2.0
Operation Humidity Range	0~90%
AC Input Ranges	AC 120V, 60Hz
Audio Output[watt]	1.5W

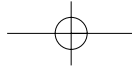

SSC21WEB NETWORK

Hardware	<ul style="list-style-type: none"> • 32bit Embedded Processor • Flash Memory : 8Mbytes • SDRAM : 32Mbytes
Network Protocols	<ul style="list-style-type: none"> • HTTP, TCP/IP, FTP, Telnet, ARP, PPP, DHCP, PPPoE
Image Compression & Quality	<ul style="list-style-type: none"> • Compression Algorithm : Real-time M-JPEG • Rate : 30 fps for each channel • Quality : 3 levels
Video Format	<ul style="list-style-type: none"> • NTSC
Video Resolution	<ul style="list-style-type: none"> • NTSC, 352x240, 704x240
Performance	<ul style="list-style-type: none"> • Max 30 Frame Per Second (NTSC)
Management	<ul style="list-style-type: none"> • Configuration by serial port or web browser • Remote Flash memory update
LAN Interface	<ul style="list-style-type: none"> • 10/100 BaseT Fast Ethernet
Security Function	<ul style="list-style-type: none"> • Password protected server access
PC Specification	<ul style="list-style-type: none"> • CPU_Pentium IV 1GHz higher • RAM_256MB or higher • Video Memory_32MB or higher • Resolution_1024x768 or higher • OS_Windows 98/ME/2000/XP Service Pack installation recommended • Web Brower_Internet Explorer 5.5 or later

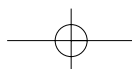

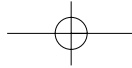

User Guide

The system performance may decrease if the computer has lower specification than the recommendations, is not installed with the latest service pack, or has an illegally installed operation system(OS).

A unique MAC address is registered to this device.
If the administrator setting and monitoring may not be available due to conflicting unregistered MAC addresses, please contact a local service center or head office.

SSC21WEB enables users to see up to four viewers on one computer.
The system may malfunction if over five viewers with low performance computers are connected to the device.

After reboot, if you reconnect Network Cable or Internet explorer, then the transmission of the Motion Images could be delayed with showing "Waiting" message or disconnected under the environment of WINDOWS 98 and Windows ME.

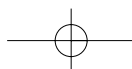

Appendix A) Software up data

The initial screen of Samsung Electronics' web site is as follows.

1. <http://www.securitysamsung.com>
<http://www.samsung.com/Products/CCTV.htm>
2. Network Security in Homepage
3. Download the following items from SSC21WEB.
 - ① Owner's manual - SSC21WEB Owner's manual
 - ② UP-GRADE S/W - kernel, RAM disk, System, Web

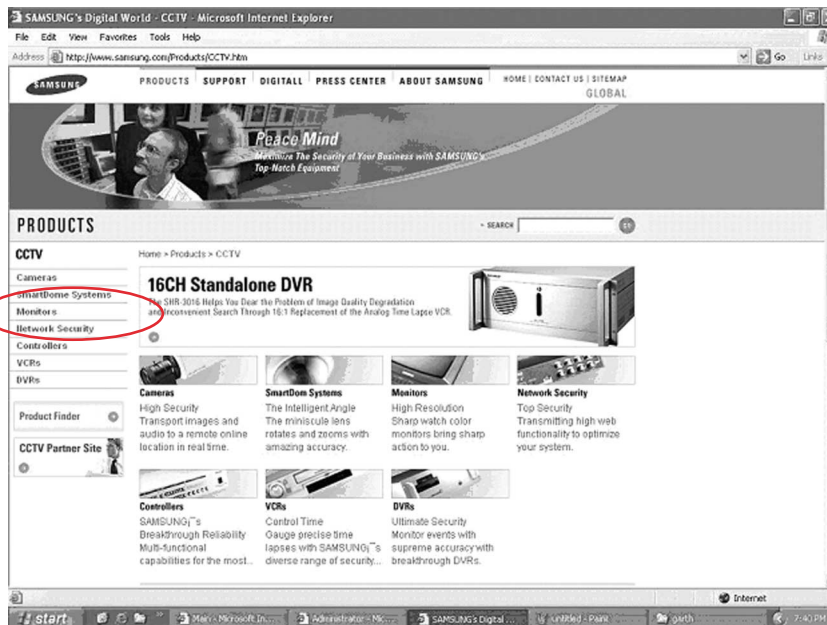

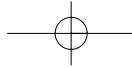

User Guide

Appendix B) IP Router Setup Guide

List of Routers compatible with SSC21WEB.

Refer to Router User's Manual for the detailed router setup.

1. Total System Configuration

2. Local System Configuration

3. Step-by-Step Examples :

Linksys (Model : WRT54G)

Netgear (Model : WGR614v4)

D-Link (Model : DI-624+)

SMC (Model : 7004VBR)

CAUTION

Other routers may be incompatible with SSC21WEB.

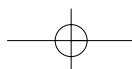

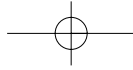

Total System Configuration

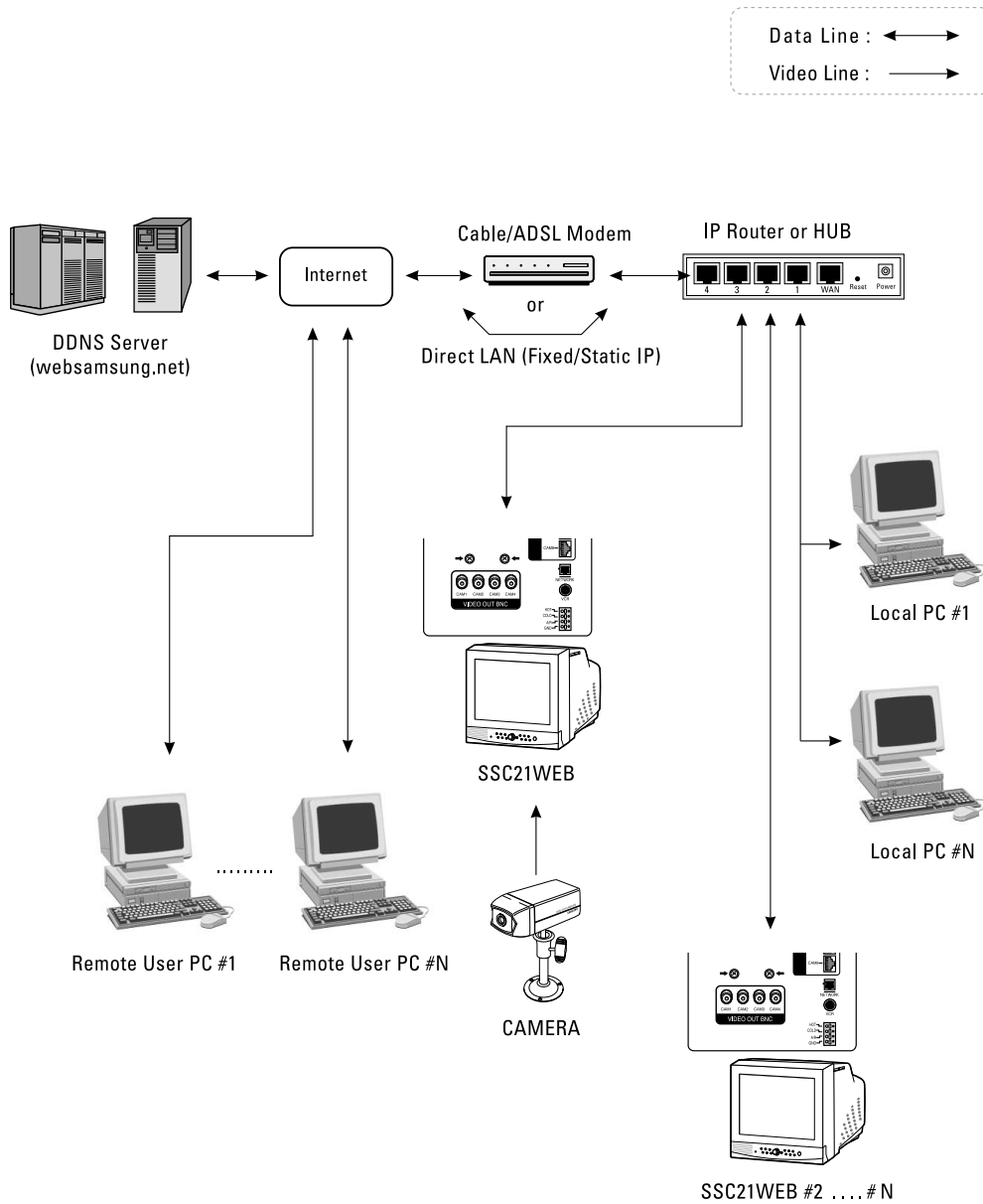

Eng-97

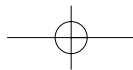

User Guide

Local System Configuration

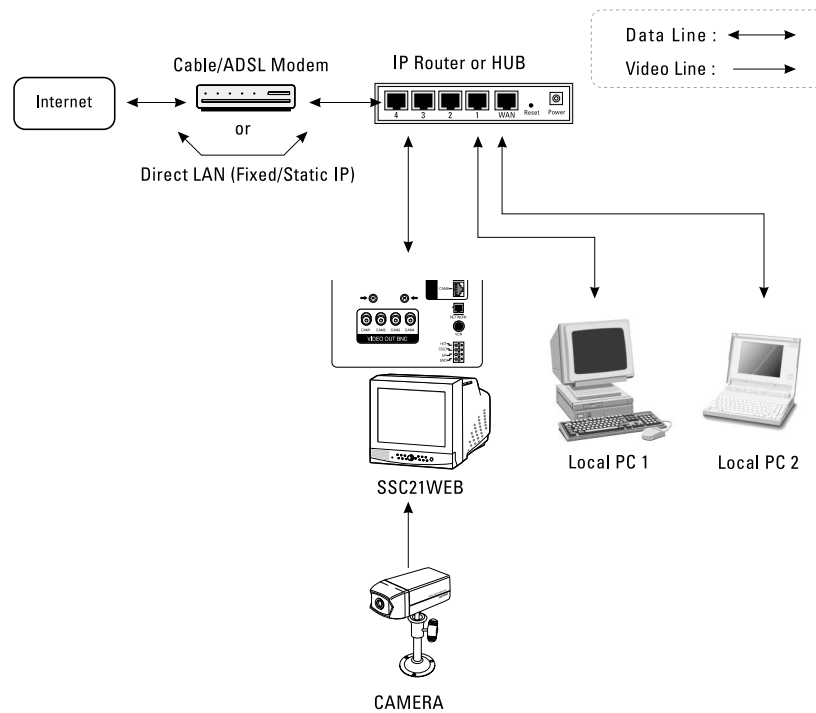

1. Connect LAN cable of Cable/ADSL modem or Direct Fixed/Static IP LAN Line to WAN port of IP Router.
2. Connect LAN ports of IP Router(1~4 or 1~8) to Ethernet port SSC21WEB to be set up and to Ethernet port of Local PC to use during setup.
3. Connect Video cable of Camera to SSC21WEB.
4. Turn on the SSC21WEB power.

Notice

If you have a Static (Fixed) IP line or Dynamic IP line (Cable Modem or ADSL Modem) with one IP address (whether its dynamic or fixed), but have more than one internet device to use (such as a PC and a SSC21WEB or several SSC21WEB); you must use an IP Router (different from a simple Network Hub); you must set up the Router to work with the SSC21WEB; and you must use a network capable PC within the local Router network to do the setup.

If you are using an existing Router which is already set up, you may not need to redo the basic setup of the Router again, but it is highly recommended that you at least read all the instructions below and go through the steps. Whether you are using an existing Router or a new Router, you must go through the Port Forwarding portion of the setup.

Eng-98

Step-by-Step Setup Example of IP Router

Linksys model WRT54G

Port Range					
Application	Start	End	Protocol	IP Address	Enable
SSC21WE	10000 to 10000	TCP	192.168.1.101	<input checked="" type="checkbox"/>	
	0 to 0	TCP	192.168.1.1	<input type="checkbox"/>	
	0 to 0	TCP	192.168.1.1	<input type="checkbox"/>	
	0 to 0	TCP	192.168.1.1	<input type="checkbox"/>	
	0 to 0	Both	192.168.1.0	<input type="checkbox"/>	
	0 to 0	Both	192.168.1.0	<input type="checkbox"/>	

1. Click the “Application and Gaming” tab.

2. Click “Port Range Forward”.

3. Port forwarding

Row #1 :

① Application : Set this to “HTTP”

② Start and End : Set both to “From 10000 to 65535”

③ Protocol : Select “TCP”

④ IP Address : SETUP MENU -> 7. NETWORK SETUP -> Check IP from network status to apply it identically to Private IP after DHCP setup.

(Eng-32 Setup)

* It is not in use by any other device connected to the IP Router including the Local PC.

⑤ Enable : Leave this “checked”

4. Click “Save Settings”

5. Close browser window.

Eng-99

User Guide

Step-by-Step Setup Example of IP Router

Netgear model WGR614v4

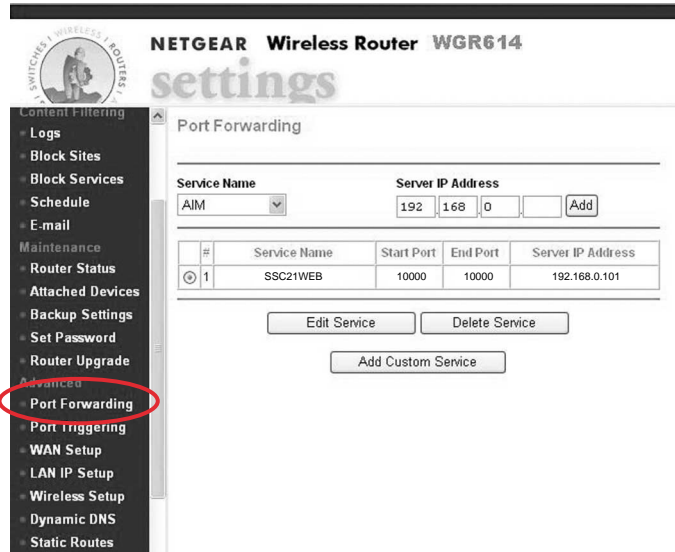

1. Click the "Router Status"
2. Click the WAN and LAN Port information.
Write down the WAN Port IP Subnet Mask number and the LAN Port IP Address number.
You will need it later when setting up the SSC21WEB.
3. Click "Advanced" and "Port Forwarding"
4. Port forwarding (HTTP)
 - ① Click "Add Custom Service"
 - ② Service Name : Set this to "HTTP"
 - ③ Start Port and End Port : Set both to "From 10000 to 65535"
 - ④ Server IP Address : SETUP MENU -> 7. NETWORK SETUP -> Check IP from network status to apply it identically to Private IP after DHCP setup. (Eng-32 Setup)
* It is not in use by any other device connected to the IP Router including the Local PC.
 - ⑤ Make sure "Enable" is checked.
 - ⑥ Click "Add"
5. Close browser window.

Eng-100

Step-by-Step Setup Example of IP Router

D-Link model DI-624+

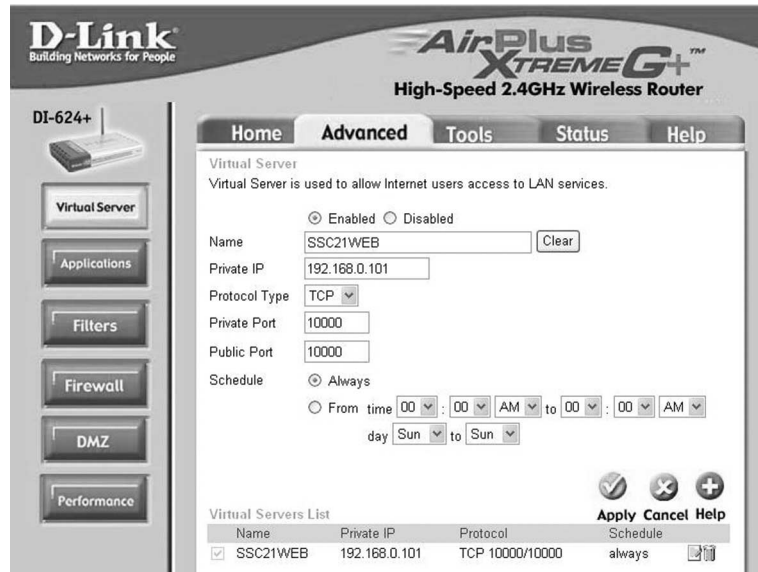

1. Select "Virtual Server" and "Advanced"

You need to create Virtual Servers (Port Forwarding) for HTTP, TCP and Upgrade separately.

2. Virtual Server (Port Forwarding) for HTTP

- ① Enabled : Leave this "checked"
- ② Name : Set this to "HTTP"
- ③ Private IP : SETUP MENU -> 7. NETWORK SETUP -> Check IP from network status to apply it identically to Private IP after DHCP setup.
(Eng-32 Setup)

* That is not in use by any other device connected to the IP Router including the Local PC.

- ④ Protocol Type : Select "TCP"
- ⑤ Private Port and Public Port : Set both to "From 10000 to 65535"
- ⑥ Schedule : Select "Always"
- ⑦ Click "Apply"

3. Close browser window.

Eng-101

User Guide

Step-by-Step Setup Example of IP Router

SMC model 7004VBR

Virtual Server

You can configure the Baricade as a virtual server so that remote users accessing services such as the Web or FTP at your local site via public IP addresses can be redirected to local servers configured with private IP addresses. In other words, depending on the requested service (TCP/UDP port number), the Wireless Baricade redirects external service request to the appropriate server (located at another internal IP address).

Well known services: -- select one -- ID

ID	IP Address	Port's	Data Type	Enable
1	192.168.2.101	10000	TCP	<input checked="" type="checkbox"/>
2	192.168.2.		TCP	<input type="checkbox"/>
3	192.168.2.		TCP	<input type="checkbox"/>
4	192.168.2.		TCP	<input type="checkbox"/>
5	192.168.2.		TCP	<input type="checkbox"/>
6	192.168.2.		TCP	<input type="checkbox"/>
7	192.168.2.		TCP	<input type="checkbox"/>

1. Select "NAT" and "Virtual Server"

You need to create Virtual Servers (Port Forwarding) for HTTP

2. Virtual Server (Port Forwarding) for HTTP : use the first empty ID row.

- ① IP Address : SETUP MENU -> 7. NETWORK SETUP -> Check IP from network status to apply it identically to Private IP after DHCP setup.
(Eng-32 Setup)

* That is not in use by any other device connected to the Router including the Local PC.

- ② Private Port and Public Port : Set both to "From 10000 to 65535"

- ③ Data Type : Select "TCP"

- ④ Enable : Leave this "checked"

3. Click "APPLY"

4. Close browser window.

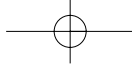

Samsung CCTV dba GVI
2801 Trade Center Drive. Suite 120
Carrollton, TX 75007
Toll Free : 888-595-2288

Part No.: AA68-03509A
Printed in Korea

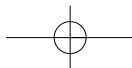

Free Manuals Download Website

<http://myh66.com>

<http://usermanuals.us>

<http://www.somanuals.com>

<http://www.4manuals.cc>

<http://www.manual-lib.com>

<http://www.404manual.com>

<http://www.luxmanual.com>

<http://aubethermostatmanual.com>

Golf course search by state

<http://golfingnear.com>

Email search by domain

<http://emailbydomain.com>

Auto manuals search

<http://auto.somanuals.com>

TV manuals search

<http://tv.somanuals.com>