

# **SWL-3000AP Series**

## **Access Point User's Guide**



**\* This User's Guide can be used on SWL-3000AP, 3000AP(DA), 3300AP and 3300AP(DA).**

### **Notice when you establish**

\* We recommend you to avoid this places where may be cause of performance decline or trouble.

1. Places with high humidity or wet condition
2. Places with extreme temperature(too hot or too cold)
3. Places where change of temperature is extreme
4. Places with a lot of dusts
5. Places sealed with thick walls or still structure

### **Notice when you use**

1. Do not disassemble on your own.
2. Do not drop the product or give excessive impact.
3. Do not twist or lengthen the power cord.
4. Do not place any object on the product.
5. Do not use any parts or components, which are not provided.
6. Use only the power adapter provided.

### **This Guide is a copyright of :**

Samsung Electro-Mechanics Co., Ltd.  
314 Maetan-3 Dong, Paldal-Gu  
Suwon, Kyunggi-Do, 442-743  
Korea.

### **SWL-3000AP Series Access Point User's Guide**

First Edition (November 2001)

### **Models subjected to this User's Guide :**

SWL-3000AP, 3000AP(DA), 3300AP, 3300AP(DA)

\* DA : Dipole Antenna Type

## Table of Contents

1.	Introduction.....	1
2.	Installation.....	3
3.	AP Basic Setting Using AP Manager.....	5
4.	PTP Setting Using AP Manager.....	10
5.	AML Setting Using AP Manager.....	14
6.	Bridge Table and Protocol Management Using AP Manager.....	19
7.	NAT Setting Using AP Manager.....	22
8.	DHCP Server Setting Using AP Manager.....	27
9.	NAT and DHCP Server Simultaneous Setting Using AP Manager .....	32
10.	ADSL and Cable Modem Connection Setting Using AP Manager .....	35
11.	Encryption Setting Using AP Manager.....	44
12.	User Access Control Setting Using AP Manager.....	47

13. Firmware Upgrade Using AP Manager .....	52
14. Data Transmission Status Check Using AP Manager·	55
15. AP Setting Using Web Browser.....	58
16. AP Setting Using TELNET.....	60
17. HyperTerminal Setting for RS-232C(COM Port) Communication.....	61
18. AP Basic Setting Using RS-232C(COM Port).....	62
19. Load Default Values Using RS-232C(COM Port).....	71
20. Firmware Upgrade Using RS-232C(COM Port).....	72

## APPENDIX I .

Explanation of Basic Configuration to use AP Manager	76
--	----

## APPENDIX II .

Specification.....	81
--------------------	----

**Also, this equipment is available for home use.**

This device complies with part 15 of the FCC Rules.

Operation is subject to the following two conditions:

- (1) This device may not cause harmful interference, and
- (2) this device must accept any interference received,  
including interference that may cause undesired operation.

# 1. Introduction

Thank you for purchasing SAMSUNG SWL-3000AP Series Access Point(AP).  
This guide describes the installation and basic configuration of the Access Point.  
Standard Model is SWL-3300AP for example.

## AP Components

- SWL-3000AP Series Access Point
- Wireless LAN Card (Internal for SWL-3300 and 3300(DA) models)
- RS-232C Serial Cable
- Power Adaptor
- Specific power cord for each country
- CD (AP Manager, User's Guide)

## AP View

- The Front and Rear View of SWL-3000AP

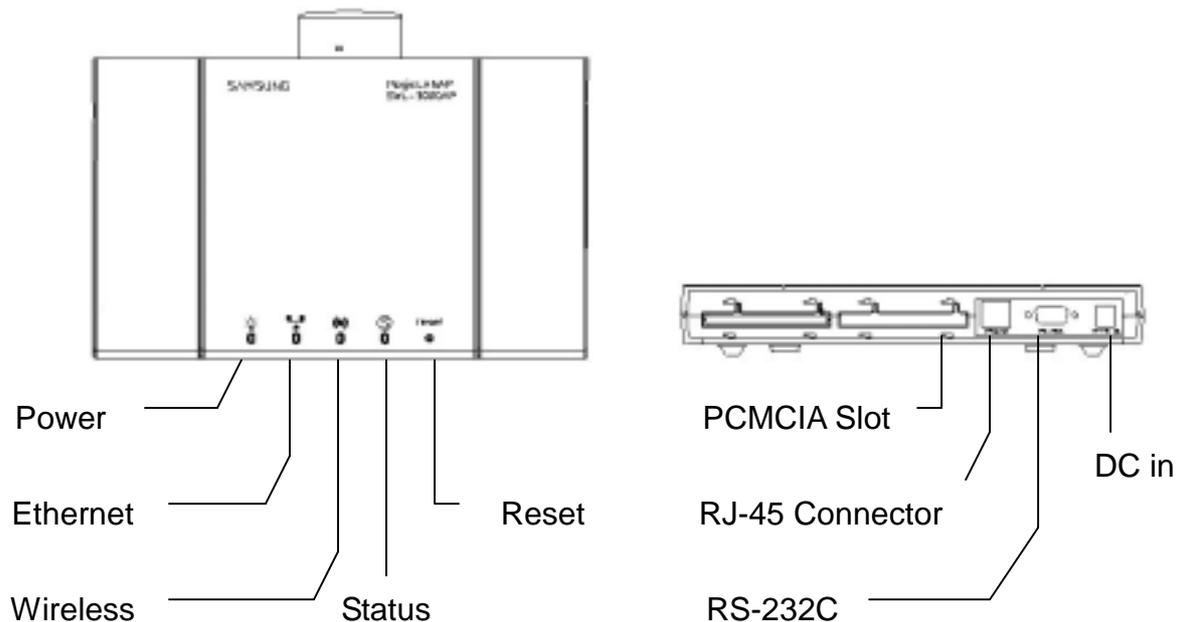

- The Front and Rear View of SWL-3000AP(DA)

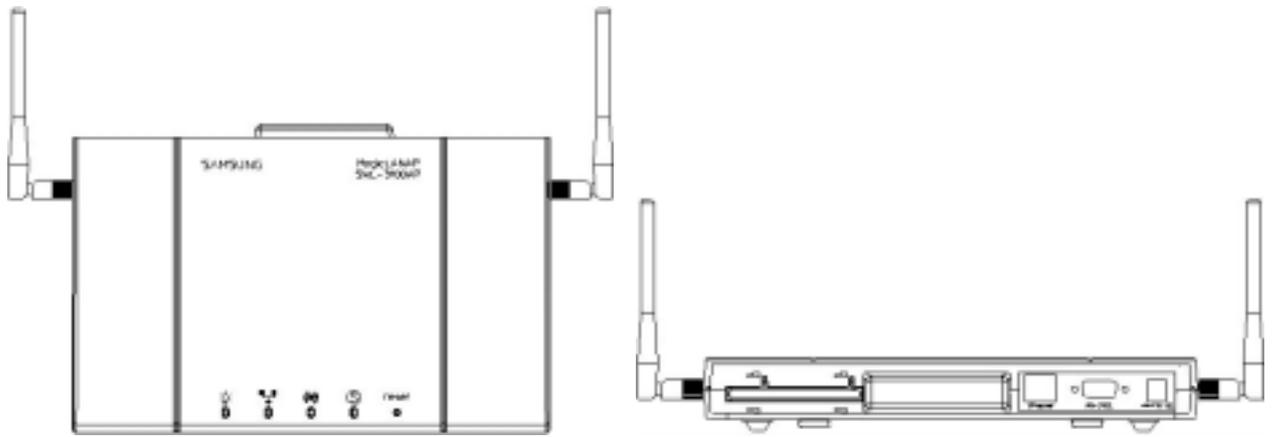

- The Front and Rear View of SWL-3300AP

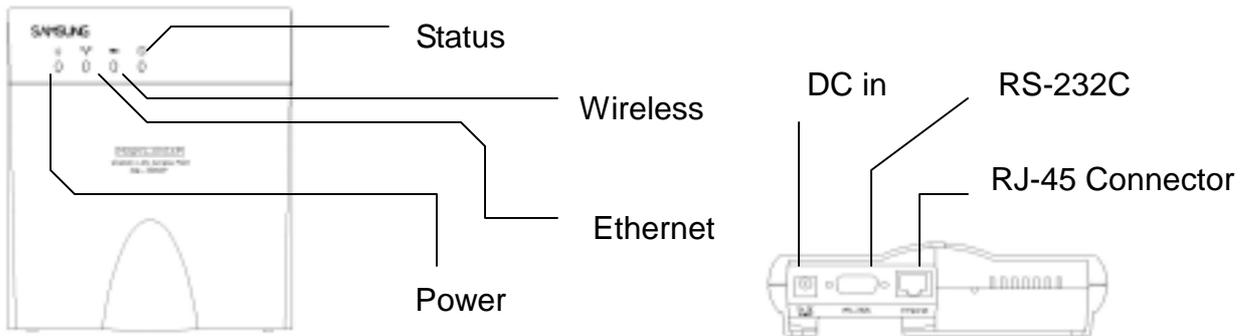

- The Front and Rear View of SWL-3300AP(DA)

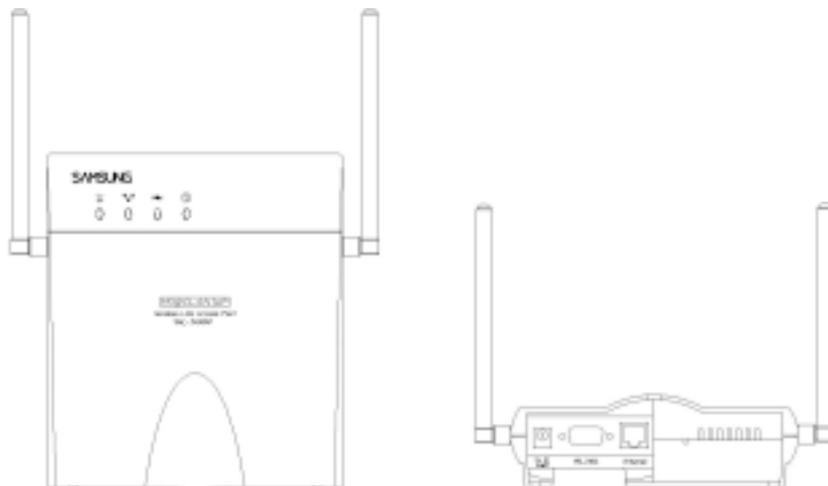

## 2. Installation

Choose the place with the consideration of power outlet and network connection (RJ-45 Cable connection) to install the Access Point.

Plug in the power cord to the power outlet and the power adapter.

Plug in the DC output to “DC in”. Make sure that the “Power” LED is on. If the “Power” LED is not on, please check the connections of the power cord.

**Notice** : *Use the supplied power adapter(DC 5V, 2A) **only** to prevent the permanent failure of AP.*

Confirm that “Wireless” LED of AP blinks.

If not, confirm that Wireless LAN Card of AP is properly mounted in case for 3000AP and 3000AP(DA). For 3300AP and 3300AP(DA), contact where you purchase the product. The card should be inserted or extracted when the power is off, and we are not responsible for any product failure due to disassemble by users.

**Notice** : *Use the supplied Wireless LAN card(3.3V) **only** to prevent the permanent failure of AP.*

Attach UTP Ethernet cable to the RJ-45 Connector.

Make sure that the “Ethernet” LED is on. If the “Ethernet” LED is on, you can use the existing network with the Access Point; otherwise check the UTP cable connections.

Attach RS-232C serial cable to the Access Point and the PC.

The parameters of Access Point can be configured through the connection of RS-232C serial cable to the PC(Refer to Chapter 17).

When AP Manager is used, you may skip the step .

Change settings of AP according to user’ s selection referring User’ s Guide.

Insert Wireless LAN Card into your PC.

Wireless LAN Cards are available both for desktop and notebook PCs. PCI Wireless LAN Card is used for the desktop PC where as the PCMCIA Wireless LAN Card is for the notebook PC only. For more information about PCI and PCMCIA Wireless LAN Cards, please visit <http://www.magiclan.com>.

Enter the same ESSID that you have set for the Access Point, using the Wireless LAN Card utility running on your PC.

Through AP, which is installed and set by the method above, you can communicate between server and PC with installed Wireless LAN Card.

Ethernet, ADSL,  
and Cable Modem

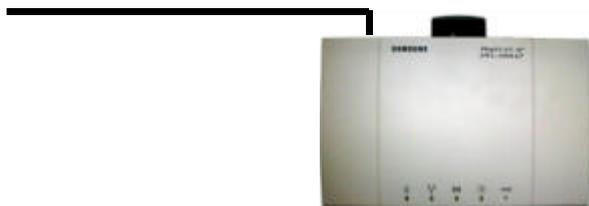

SWL-3000AP



**[Models subjected to this User's Guide]**



SWL-3000AP(DA)



SWL-3300AP



SWL-3300AP(DA)

### 3. AP Basic Setting Using AP Manager

- ① Execute AP Manager(SWL-3000AP Series, 4000AP Series Management Utility) under MS-Windows 95/98/Me/2000/NT/XP operating system.



- ② After choosing AP, which will be used by users, on "List Box" of AP Manager using mouse, select [Basic] tab for any changes on setting.

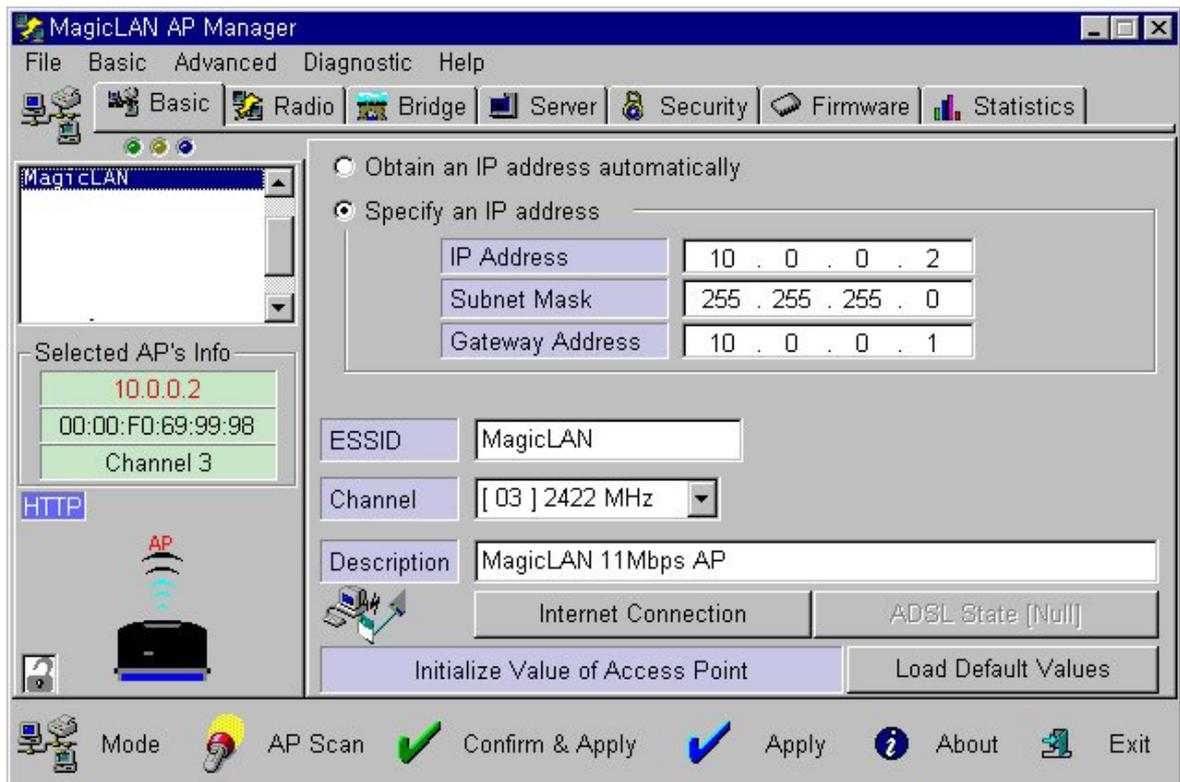

- ③ AP information of the selected AP will appear on [Selected AP's Info] Group Box. You may refer to APPENDIX 1 for detailed explanation.

- ④ TCP/IP address environment is set on [Basic] Dialogue Box.

<input type="radio"/> Obtain an IP address automatically	
<input checked="" type="radio"/> Specify an IP address	
IP Address	16 . 3 . 60 . 208
Subnet Mask	255 . 255 . 255 . 0
Gateway Address	16 . 3 . 60 . 1

- ◆ Specify an IP address

After consulting with your system administrator, you enter IP Address, Subnet Mask and Gateway Address.

- ◆ Obtain an IP address automatically

This setting is possible when AP is used for DHCP Client.

- ⑤ Set ESSID and Channel number. Description is a parameter not related with any operation, and it is used only to record description or stored location of AP.

ESSID	test_AP
Channel	[ 09 ] 2452 MHz
Description	test ap

- ◆ Set ESSID for AP use.

ESSID (Max. 32 Characters) must consist of alphabetic and numeric characters excluding blank and special characters(Capital•Small letter distinction).

- ◆ Set Channel for AP use.

Channel index should be between 1 and 14(differs from country to country).

**Notice** : *If you are operating two or more Access Points in the adjoining cells, keep the appropriate channel distance to avoid the interference. We recommend you to keep the distance of at least 4 channels in the adjoining cells.*

- ⑥ Select “Change Password” on [File] menu if you want to change the password.

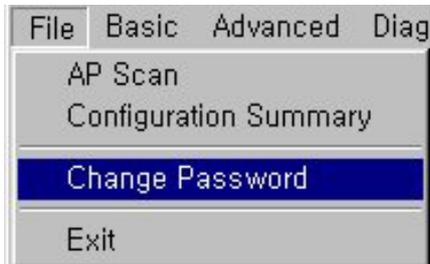

- ⑦ After entering Current Password, New Password and Retype Password, click [OK] button.

Please keep this password at a safe place or keep it where it may not get lost.

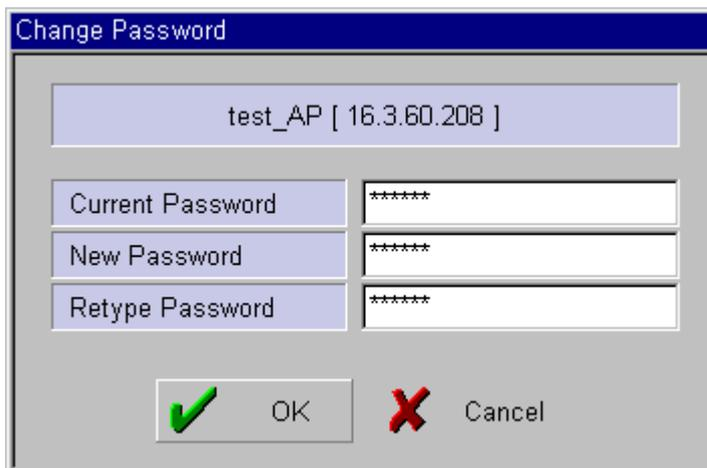

- ⑧ When you click [Confirm & Apply] button to apply new configuration, “Configuration Summary” window, which shows new configuration, will appear.

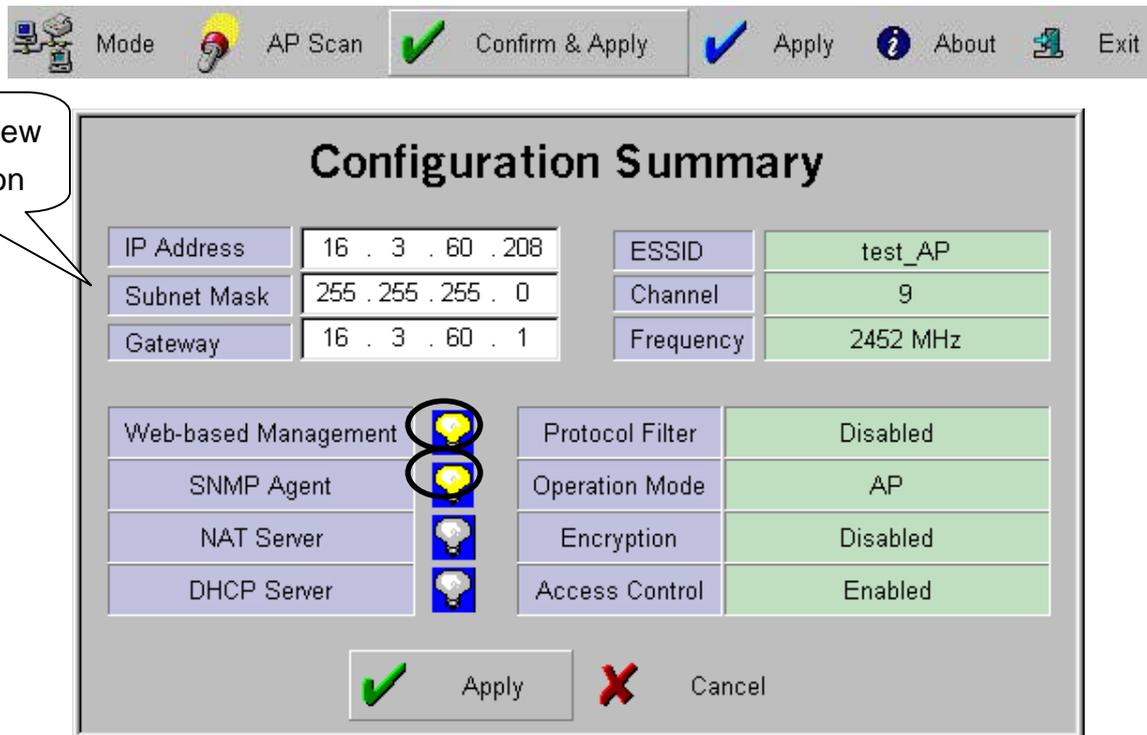

- ⑨ If new settings are entered correctly, click [Apply] button to apply new configuration.
- ⑩ When you click [Apply] button, “Password” window will appear. The default password is “public”, and user can change password later.



- ⑪ After you enter the password, click [OK] button.
- ⑫ If you want to set default values, click [Load Default values] button. Then, AP Configuration will return to default setting.

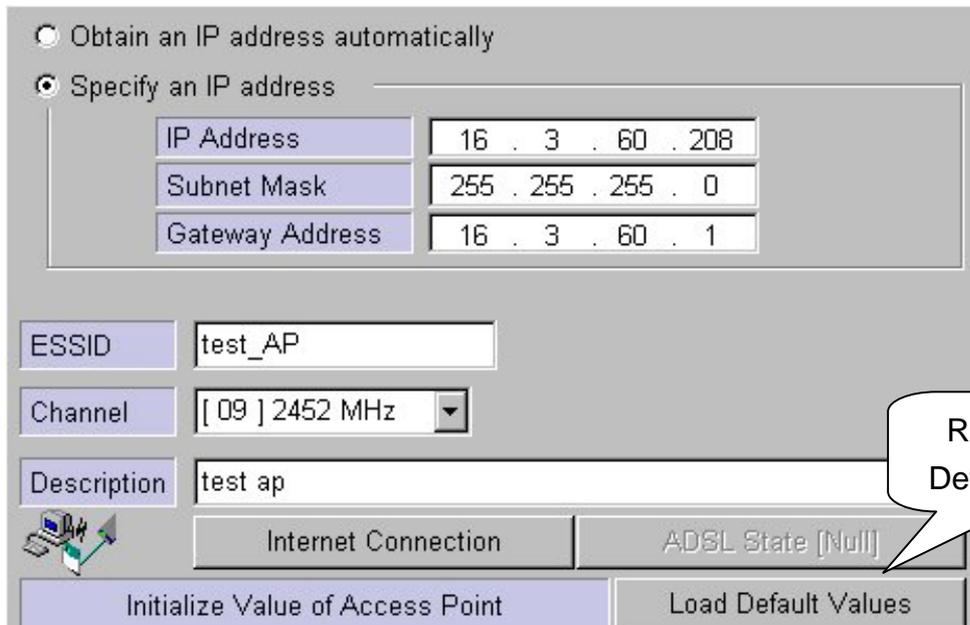

The screenshot shows a configuration window for an Access Point (AP). It has two radio buttons at the top: "Obtain an IP address automatically" (unselected) and "Specify an IP address" (selected). Below the second radio button is a table with three rows: "IP Address" with value "16 . 3 . 60 . 208", "Subnet Mask" with value "255 . 255 . 255 . 0", and "Gateway Address" with value "16 . 3 . 60 . 1". Below the table are three input fields: "ESSID" with "test\_AP", "Channel" with "[ 09 ] 2452 MHz" (dropdown), and "Description" with "test ap". At the bottom, there are two buttons: "Initialize Value of Access Point" and "Load Default Values". A speech bubble points to the "Load Default Values" button with the text "Resetting to Default Values".

IP Address	16 . 3 . 60 . 208
Subnet Mask	255 . 255 . 255 . 0
Gateway Address	16 . 3 . 60 . 1

ESSID: test\_AP  
Channel: [ 09 ] 2452 MHz  
Description: test ap

Buttons: Initialize Value of Access Point, Load Default Values

## 4. PTP Setting Using AP Manager

- ① PTP stands for Point to Point, and it is used to connect two divided networks into one using AP as Wireless Bridge. In this case, AP cannot be used for capabilities of Access Point.

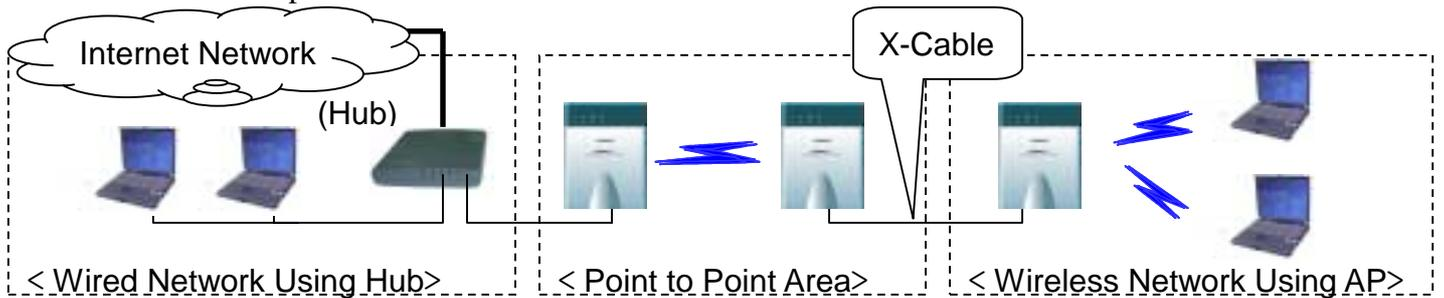

- ② After executing AP Manager, select [Radio] tab on “Tab Bar”. Select AP to set PTP on “List Box” using mouse, and confirm setting status on [Radio] Dialogue Box.

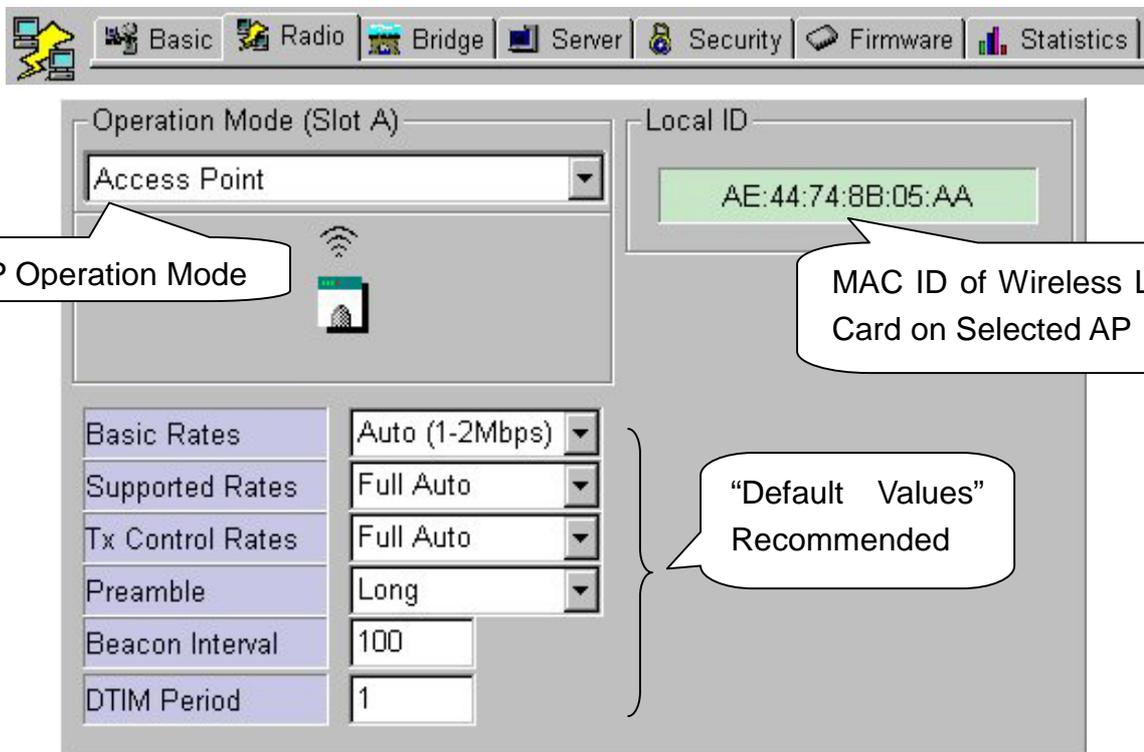

- ③ When Operation Mode of AP is selected for “Point-to-Point” on [Radio] Dialogue Box, [Remote ID (PTP)] Box will appear to enter MAC ID of Wireless LAN Card on other AP, which will be connected by using PTP mode.

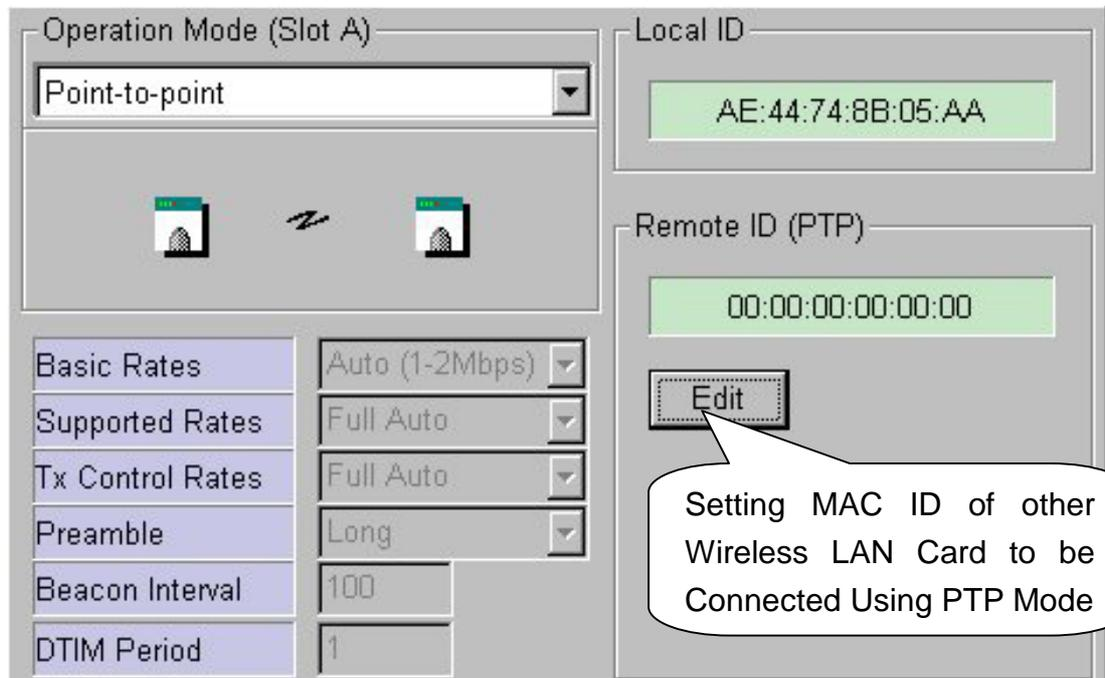
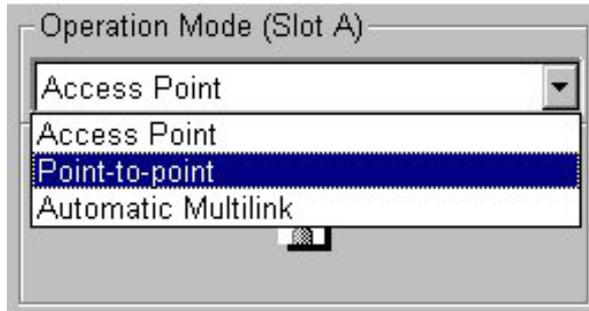

- ④ When [Edit] button on [Remote ID (PTP)] Box is selected, [MAC ID] Box, which is to enter(for entering) MAC ID of Wireless LAN Card of other AP to be connected, will appear. After entering MAC ID, click [OK] button to complete setting. MAC ID setting can be confirmed on [Remote ID (PTP)] Box.

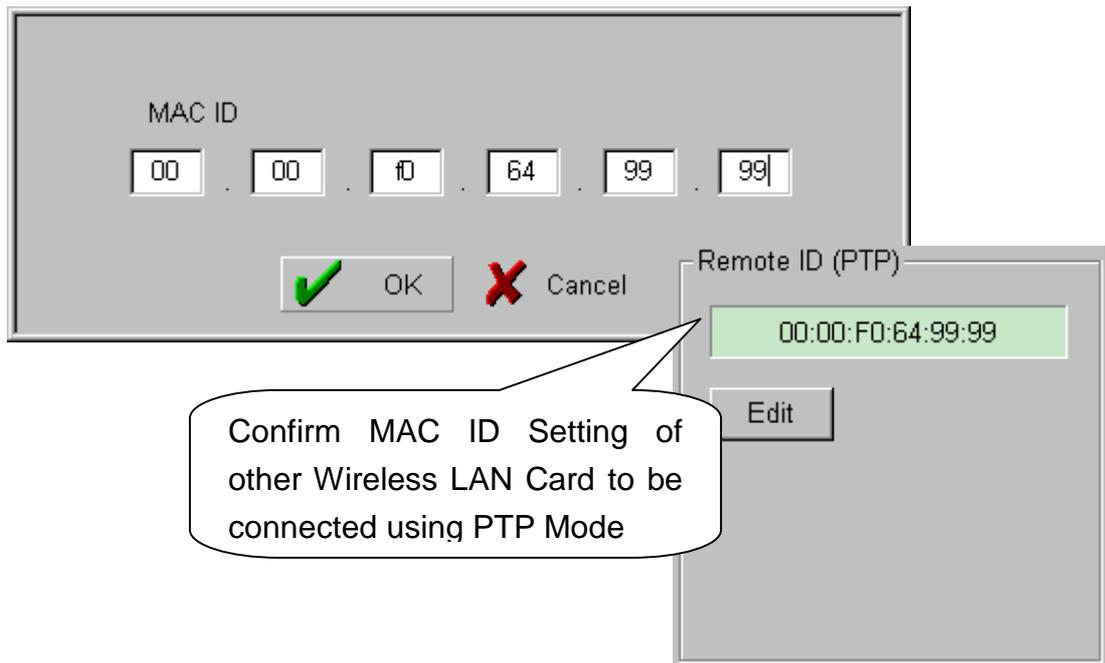

- ⑤ ESSID and Channel of two APs must be identical in PTP mode

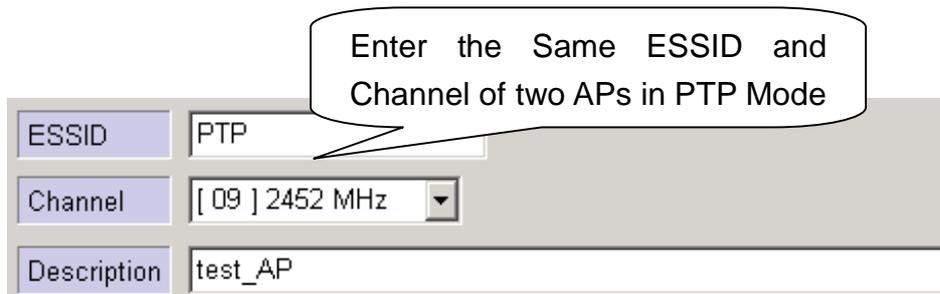

- ⑥ When you click [Confirm & Apply] button to apply new configuration, “Configuration Summary” window, which shows new configuration, will appear.

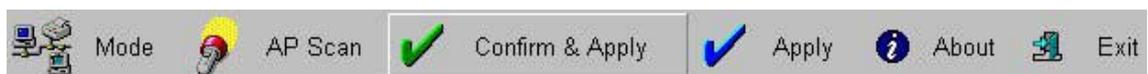

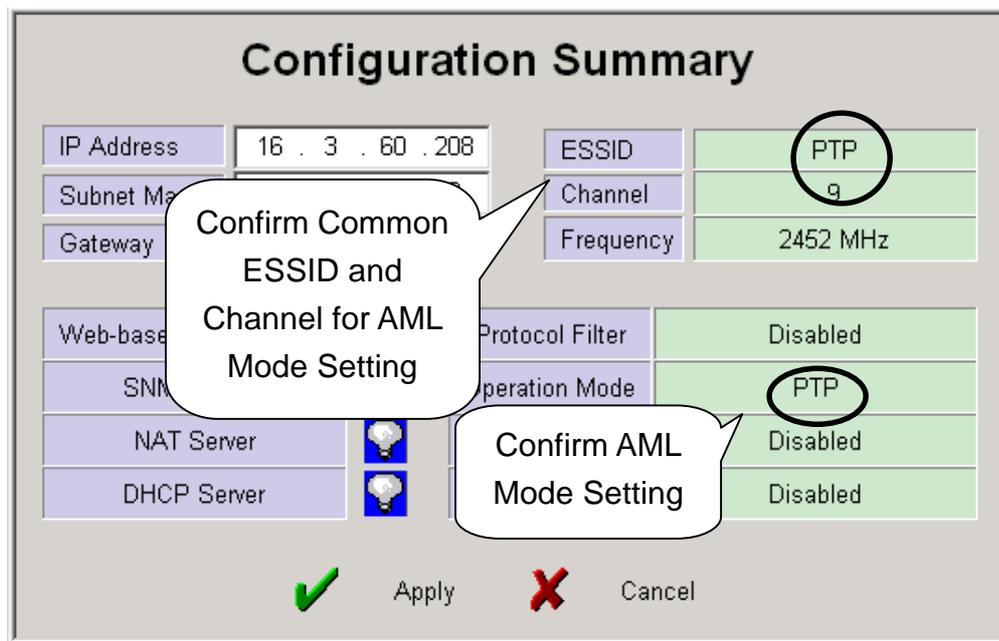

- ⑦ If new settings are entered correctly, click [Apply] button to apply new configuration.
- ⑧ When you click [Apply] button, “Password” window will appear.

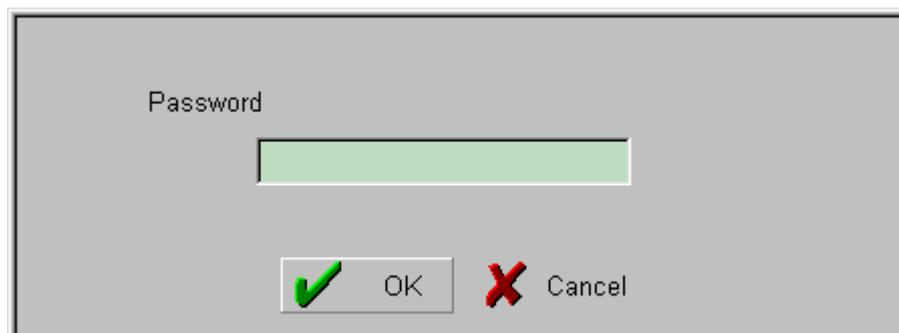

- ⑨ After you enter the password, click [OK] button.
- ⑩ When you click [Apply] button instead of [Confirm & Apply] button, “Password” window will appear immediately skipping “Configuration Summary” window. After you enter the password, click [OK] button to apply

new configuration.

- ⑪ After rebooting, choose selected proper AP on “List Box”. Then, the selected AP set with PTP Mode can be confirmed on [Selected AP’ s Info] Group Box as shown below.

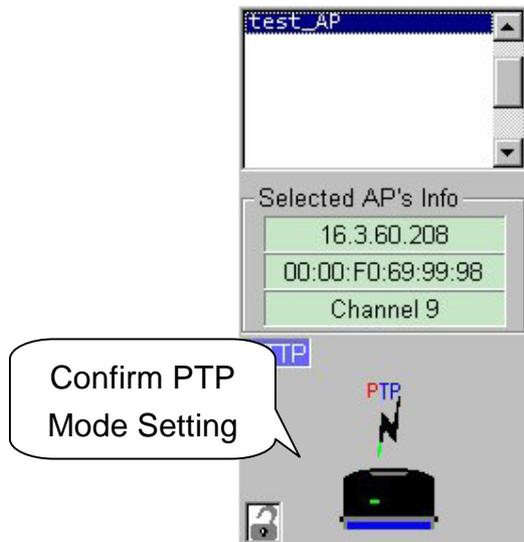

## 5. AML Setting Using AP Manager

- ① AML stands for Automatic Multi-link. Using AP as Wireless Bridge, it is used to connect several divided networks into one. It connects several [Slave]s with one main [Master].

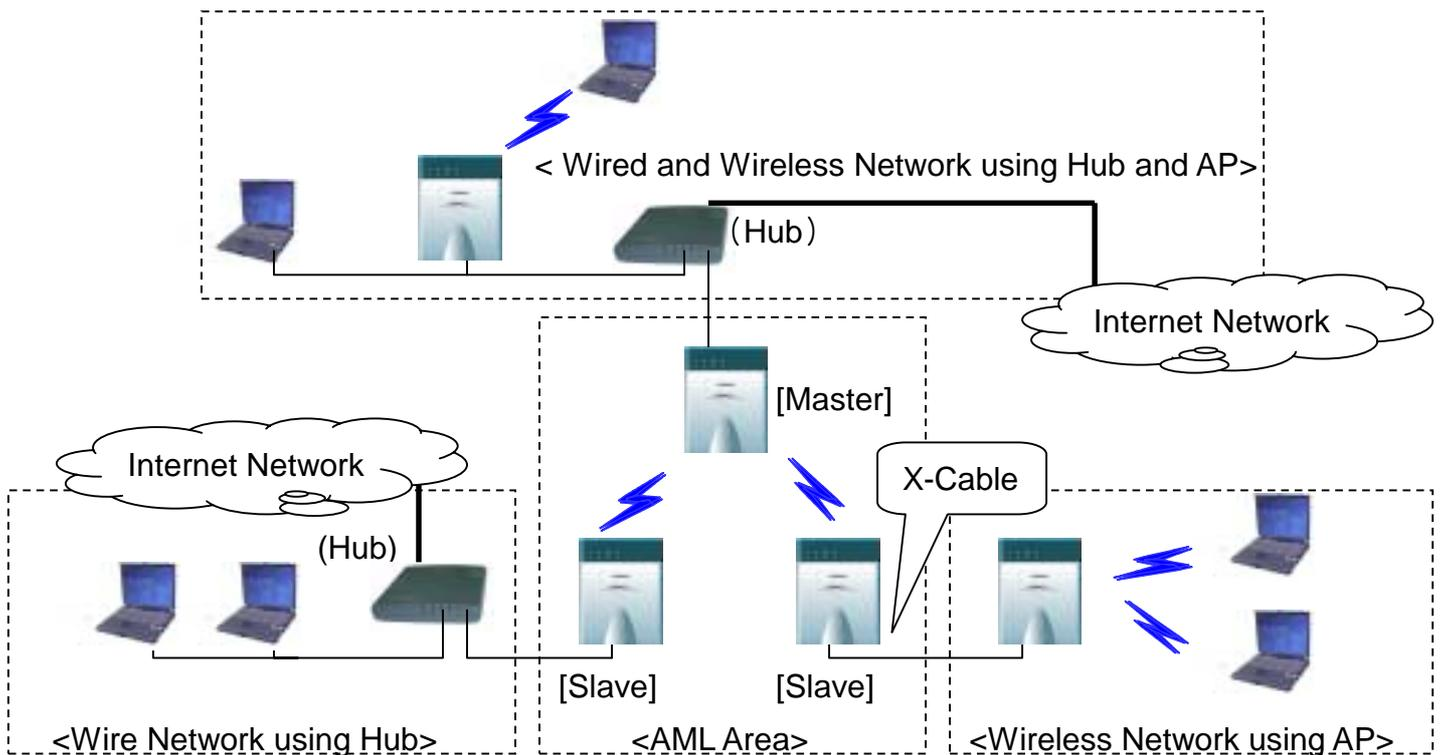

- ② After executing AP Manager, click [Radio] tab on “Tab Bar”. After selecting AP to set AML on “List Box” using mouse, set Operation Mode with “Automatic Multi-link” on [Radio] Dialogue Box.



- ③ When “Automatic Multi-link” on [Radio] Dialogue Box is selected, [Automatic Multi-link] Box, which sets AP status(Master or Slave) in AML mode, will appear.

- ④ Select either “Master” or “Slave” for [Control Mode] on [Automatic Multi-link] Box. Basically, AML Mode consists of two or more APs, and set one for “Master” and the rest for “Slave”s.

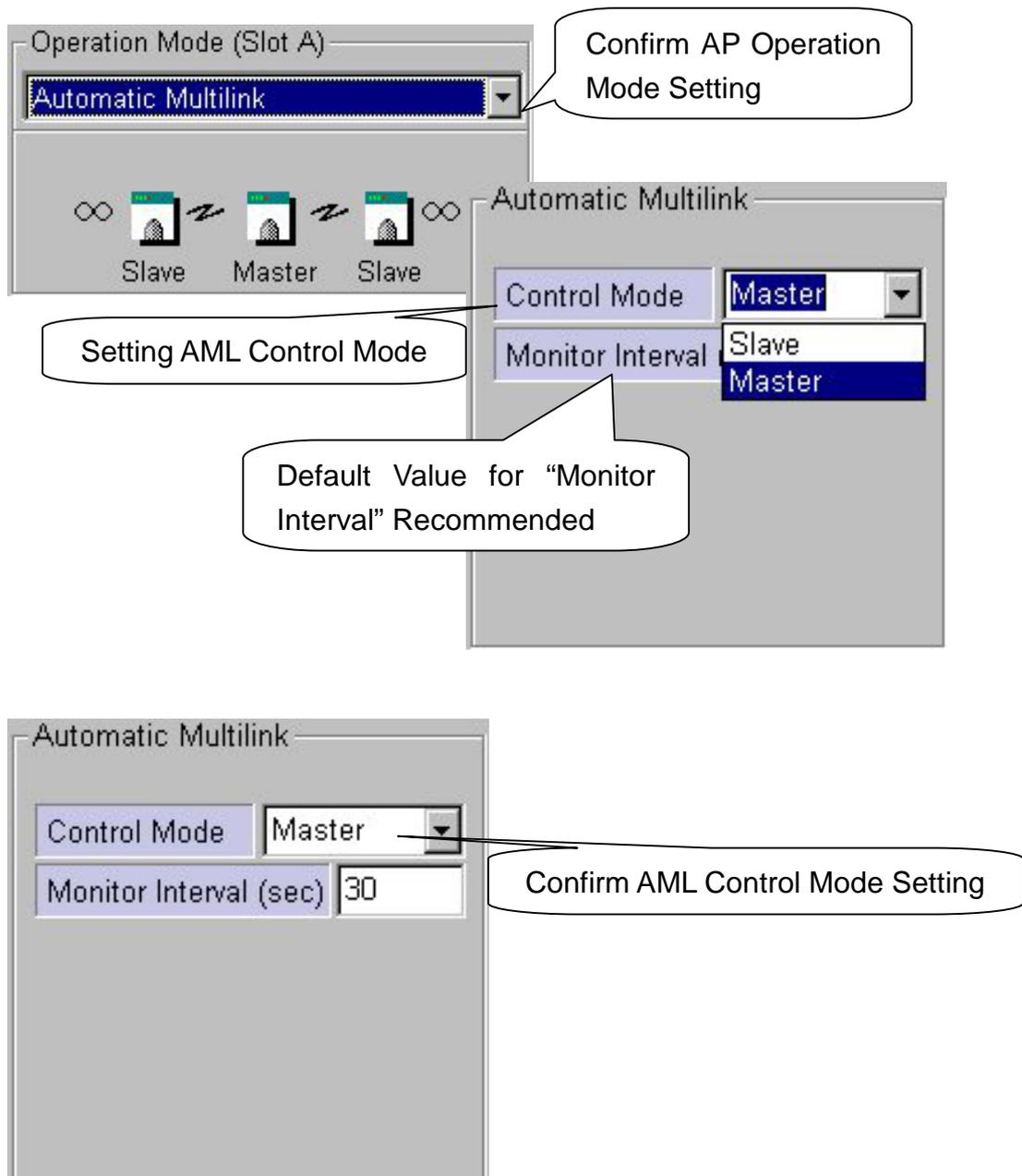

- ⑤ All of ESSID and Channel of AP set in AML mode must be identical.

Enter the Same ESSID and Channel of all APs in AML Mode

ESSID	AML
Channel	[ 09 ] 2452 MHz
Description	test_AP

- ⑥ When you click [Confirm & Apply] button to apply new configuration, “Configuration Summary” window, which shows new configuration, will appear.

Mode AP Scan Confirm & Apply Apply About Exit

### Configuration Summary

IP Address	16 . 3 . 60 . 208	ESSID	AML
Subnet M		Channel	9
Gateway		Frequency	2452 MHz
Web-bas		Protocol Filter	Disabled
SN		Operation Mode	AML
NAT Server	💡		Disabled
DHCP Server	💡		Enabled

Apply Cancel

Confirm Common ESSID and Channel for AML Mode Setting

Confirm AML Mode Setting

- ⑦ If new settings are entered correctly, click [Apply] button to apply new configuration.
- ⑧ When you click [Apply] button, “Password” window will appear.

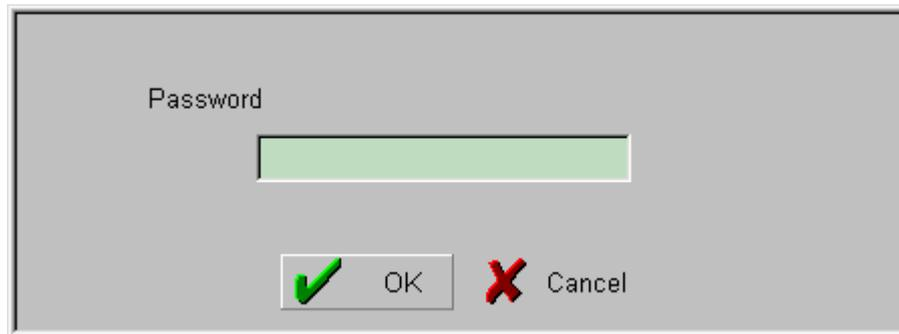

- ⑨ After you enter the password, click [OK] button.
- ⑩ When you click [Apply] button instead of [Confirm & Apply] button, “Password” window will appear immediately skipping “Configuration Summary” window. After you enter the password, click [OK] button to apply new configuration.
- ⑪ After rebooting, choose selected proper AP on “List Box”. Then, the selected AP set with AML Mode can be confirmed on [Selected AP’ s Info] Group Box as shown below.

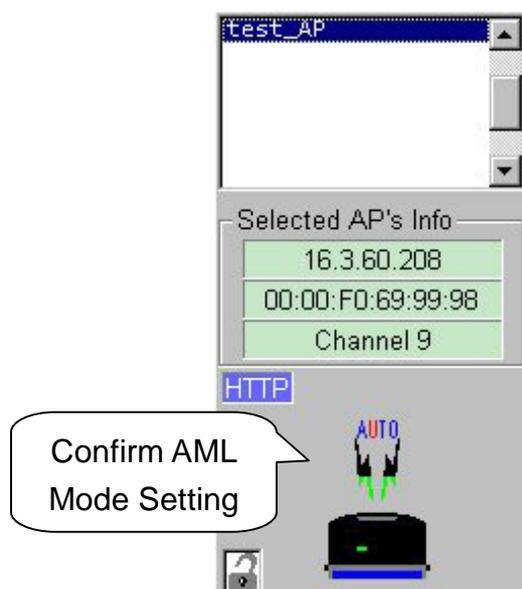

## 6. Bridge Table and Protocol Management Using AP Manager

- ① Using AP Manager, list of Wired and Wireless Station(PC or AP) connected to current AP can be confirmed. Also, it sets type of Protocol to receive and send selected data, which satisfy Protocol user wants, among data transmitting through AP.
- ② When you select [Bridge] tab on “Tab Bar” of AP Manager, two boxes, which manage “Bridge Table” and “Protocol” on Dialogue Box, will appear.

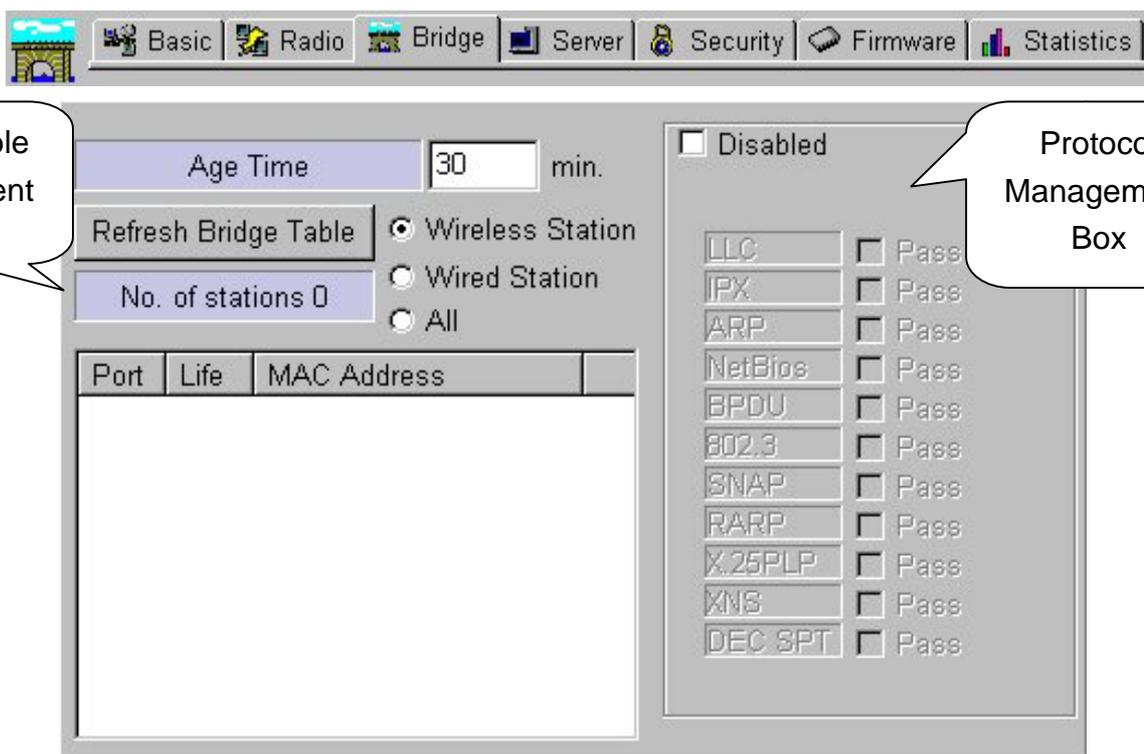

- ③ AP enables receiving and sending of data by managing currently connected Wired and Wireless Stations with “Bridge Table” consisting values of MAC Address form.

- ④ [Age Time] on [Bridge Table] Management Box shows cycle of AP refreshing “Bridge Table”. The use of Default Values is recommended.
- ⑤ After selecting Station Type you want with Radio button to refresh Stations connected to current AP, click [Refresh Bridge Table] button to confirm.

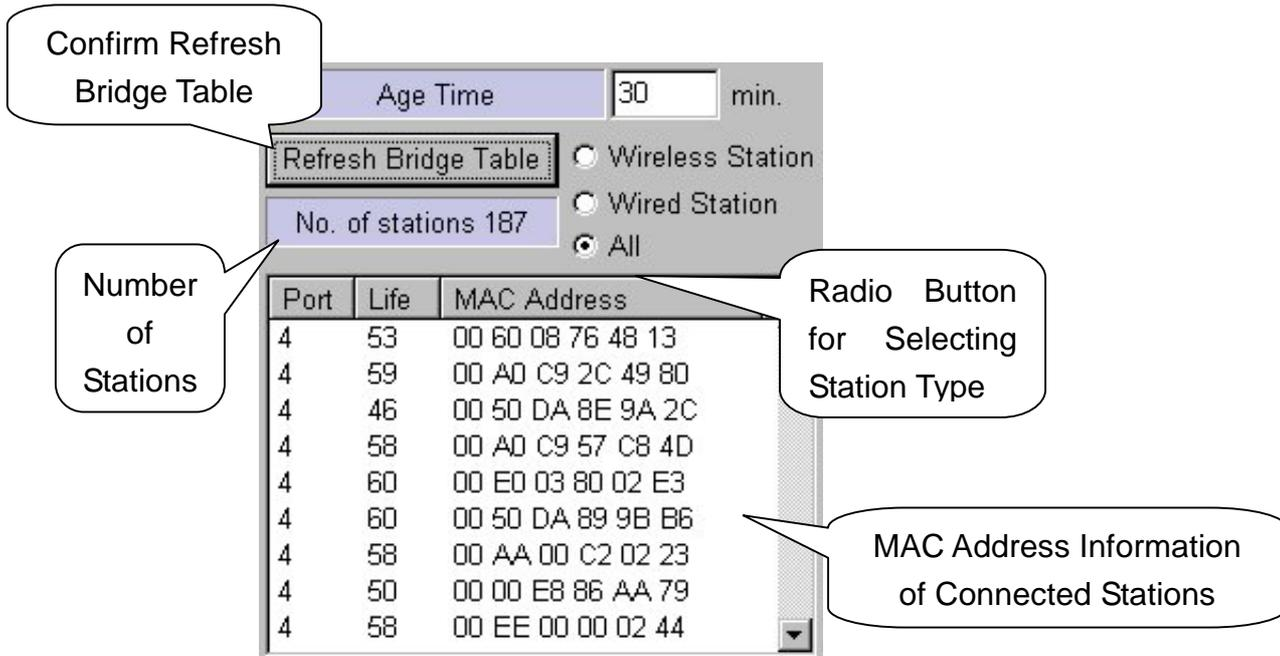

- ⑥ [Bridge Table] Management Box enables confirmation of Wired and Wireless Stations connected with current AP only.
- ⑦ You can block Protocol you do not want using [Protocol] Management Box. When Protocol use is limited, some specific applications may not operate. Therefore, before setting, consult your system administrator. “Disabled” of Default Value is recommended.
- ⑧ Selecting “Disabled” checkbox on [Protocol] Management Box leads to “Enabled”. Then, whole [Protocol] Management Box is activated to enable selecting.
- ⑨ If you select any Protocol what you do not want among Protocols shown on [Protocol] Management Box, a phrase of “Pass” changes to “Drop”.

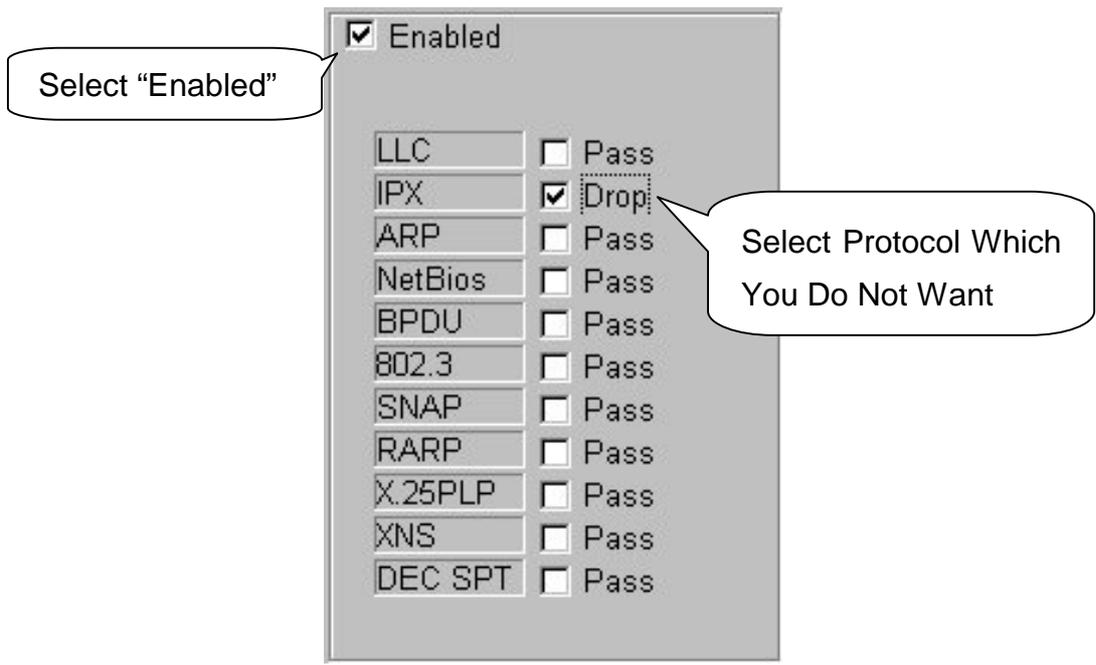

- ⑩ If new settings are entered correctly, click [Apply] button to apply new configuration.
- ⑪ When you click [Apply] button, "Password" window will appear.

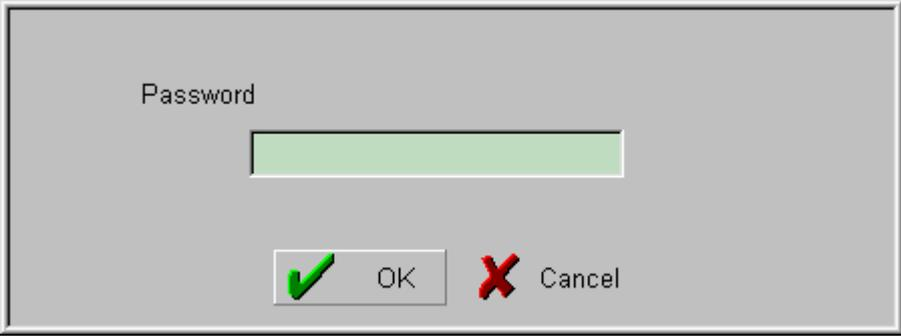

- ⑫ After you enter Password, click [OK] button.

## 7. NAT Setting Using AP Manager

- ① NAT stands for Network Address Translation, and it is used to establish private network domain. Using NAT, any desktop or notebook PC, which are connected to AP, may freely use any private IP Address. In this case, the private IP Address must have same Network Address assigned for NAT IP Address.

For Example)            NAT IP Address            :    172.16.0.1  
                                 Station IP Address #1    :    172.16.0.100  
                                 Station IP Address #2    :    172.16.0.150

In this case, Network Address is 172.16.0.X.

- ② After you select [Server] tab of AP Manager, select [NAT] on Dialogue Box. In this case, enter Gateway Address you select on “IP Address” of [NAT]. The default setting value is “172.16.0.1”.

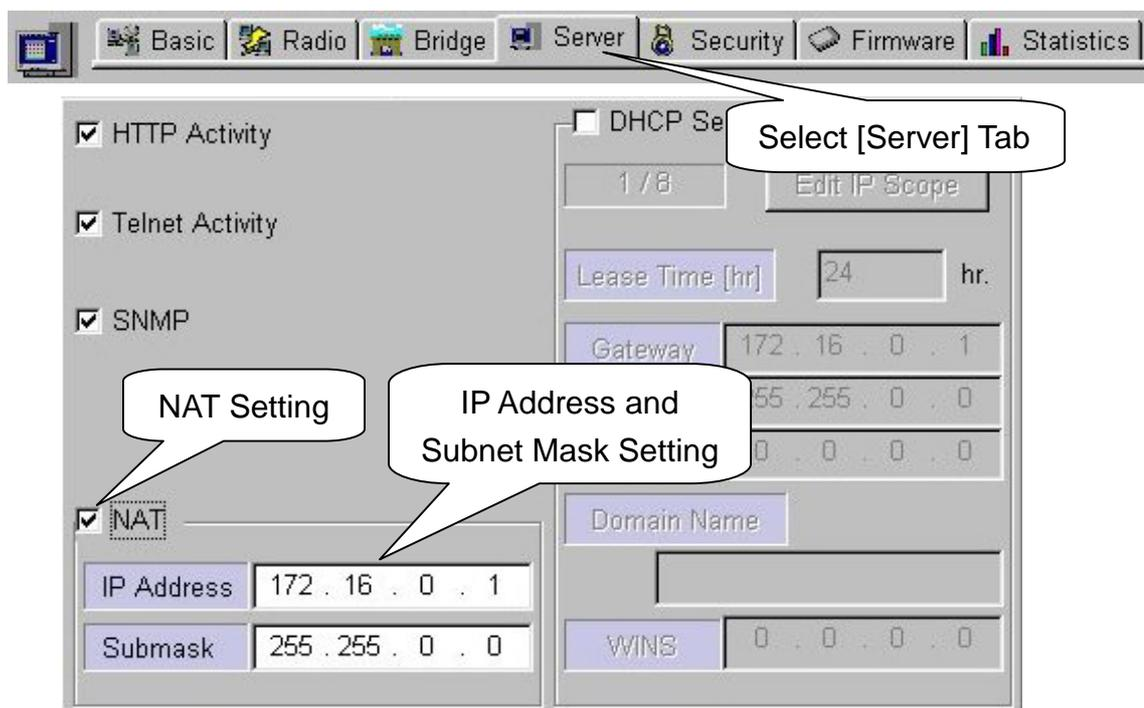

- ③ When you click [Confirm & Apply] button to apply new configuration, “Configuration Summary” window, which shows new configuration, will appear.

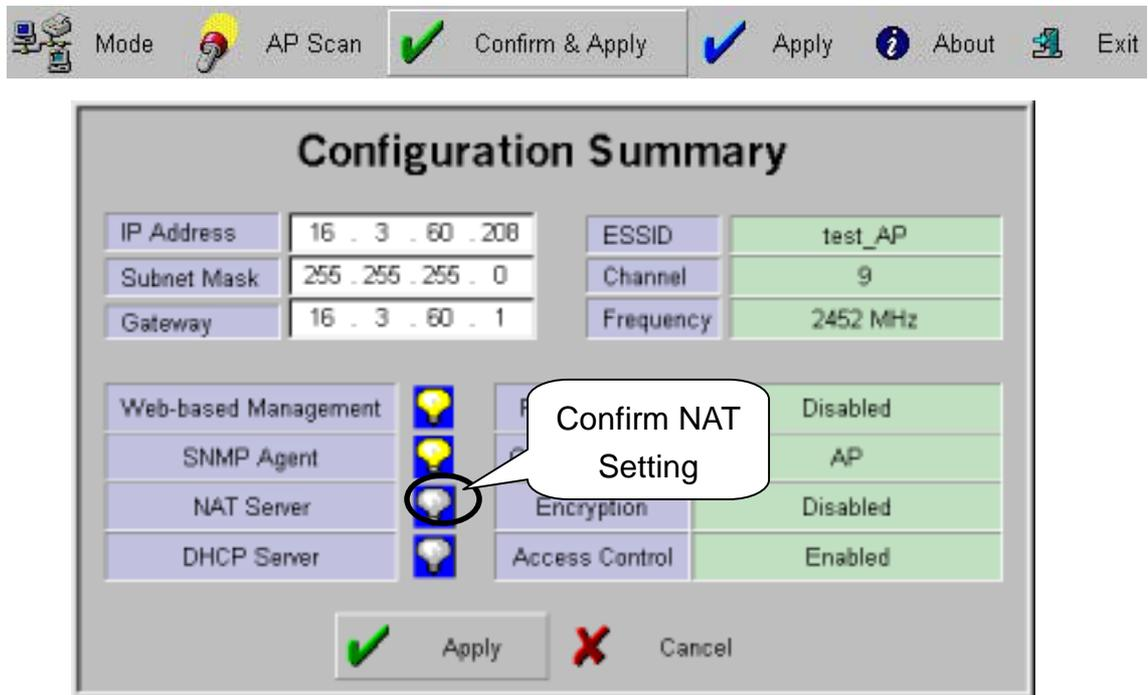

- ④ If new settings are entered correctly, click [Apply] button to apply new configuration.
- ⑤ When you click [Apply] button, “Password” window will appear.



- ⑥ After you enter the password, click [OK] button.

- ⑦ When you click [Apply] button instead of [Confirm & Apply] button, “Password” window will appear immediately skipping “Configuration Summary” window. After you enter the password, click [OK] button to apply new configuration.
- ⑧ After rebooting, choose selected proper AP on “List Box”. Then, the selected AP set with NAT can be confirmed on [Selected AP’ s Info] Group Box as shown below.

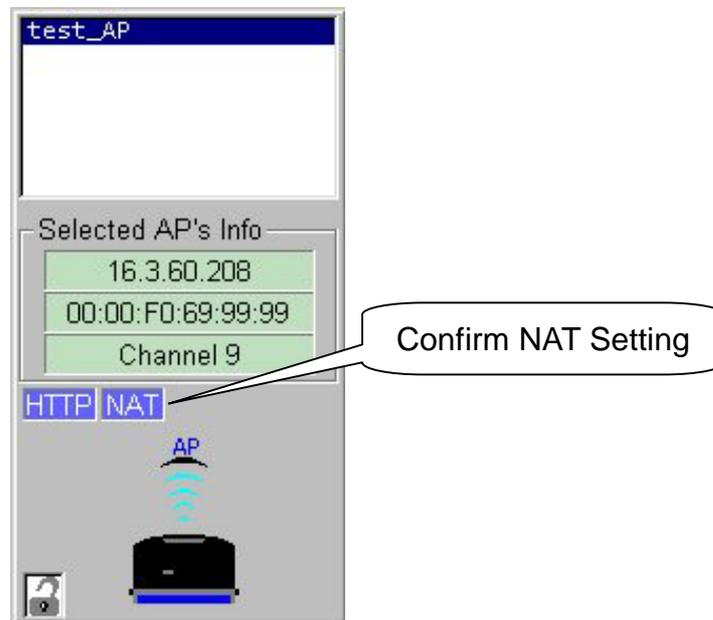

- ⑨ Configuration of Desktop or notebook PC to connect with AP under MS-Windows is shown below.

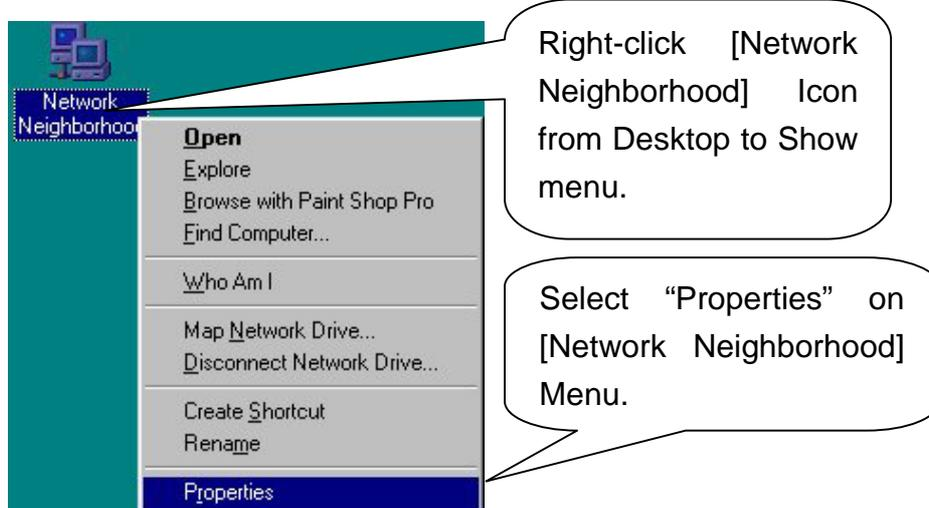

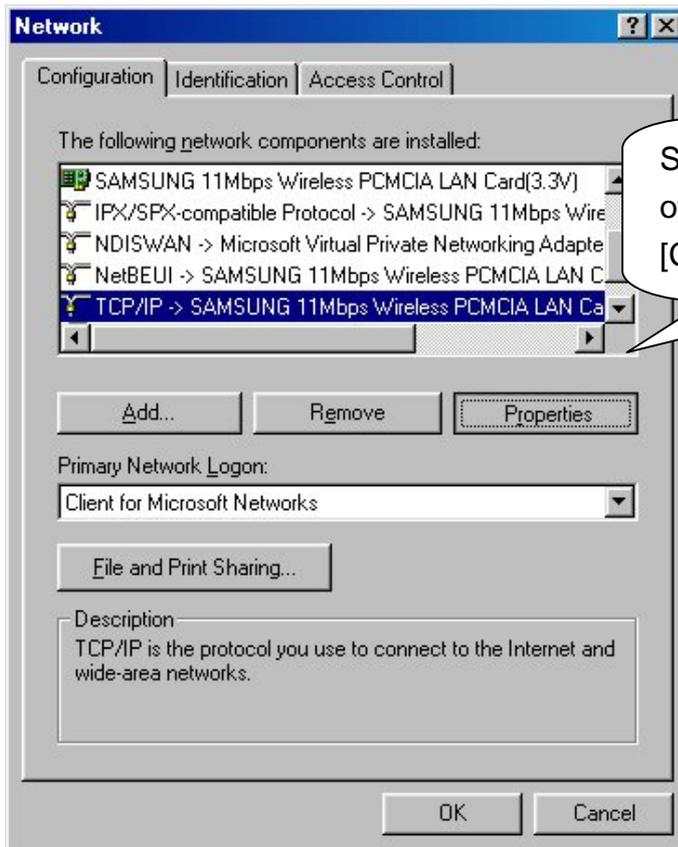

Select "TCP/IP" [Properties] of LAN Adapter to use on [Configuration] Menu.

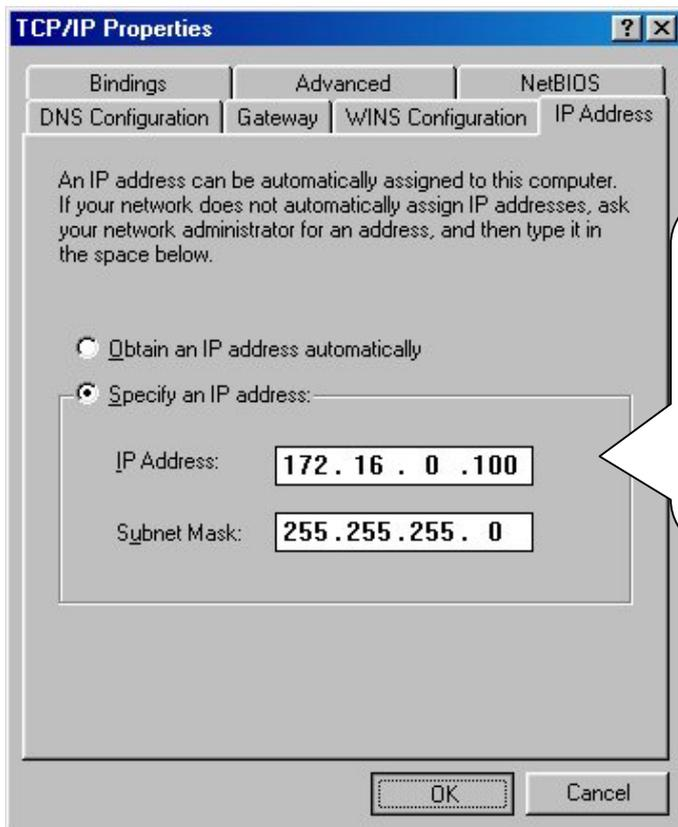

Set "IP Address" and "Subnet Mask" on [IP Address] Menu. In this case, IP Address entered on "IP Address" must have same Network Address of IP Address of AP assigned for NAT.(Refer step ①.)

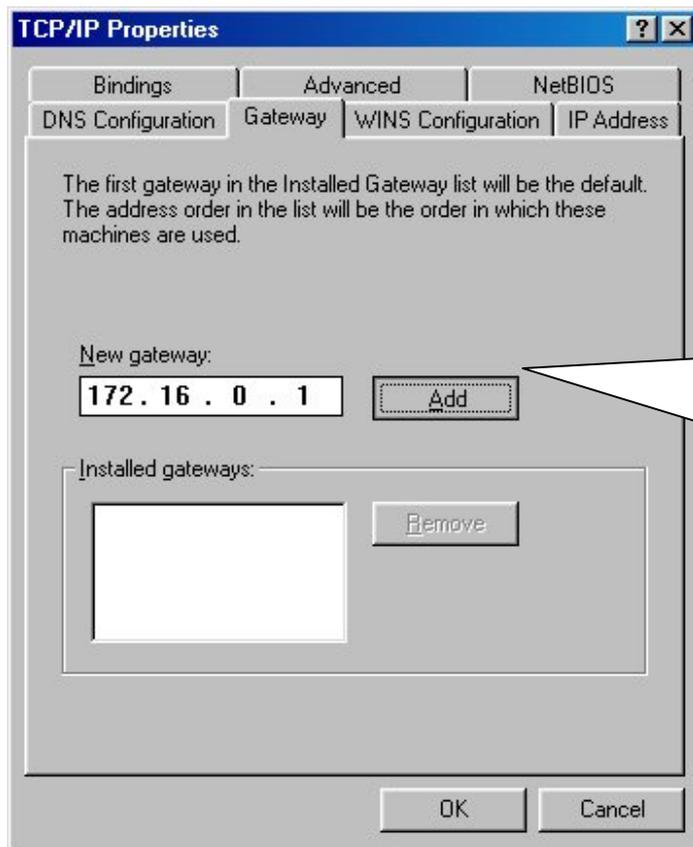

Configuration has been completed for desktop or notebook PC to connect with AP. In this case, the specified IP Address of desktop or notebook PC should have same network address as set by NAT setting.(Refer step ①.)

## 8. DHCP Server Setting Using AP Manager

- ① DHCP stands for Dynamic Host Configuration Protocol, it is protocol that enables Network administrator to manage and assign IP Address in system centrally. DHCP manages and assigns IP Address for network administrator, and it enables computer to get assigned IP Address when it is connected to other place in the network. However, any changes of IP Address of Web server and FTP server may cause confusion. Therefore, fixed IP Address should be used, and we recommend not to use DHCP.
- ② After executing AP Manager, select [Server] tab on “Tab Bar”. Then, select “DHCP Server”.

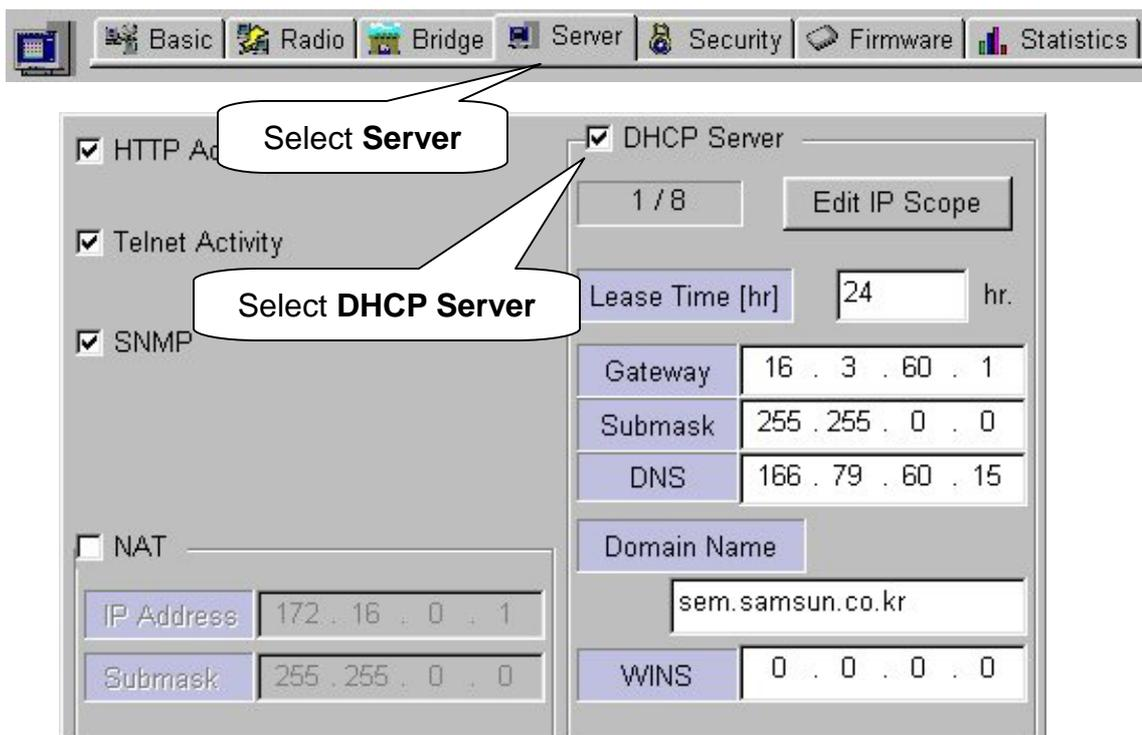

- ③ Configuration of “DHCP Server” is shown on the next page.

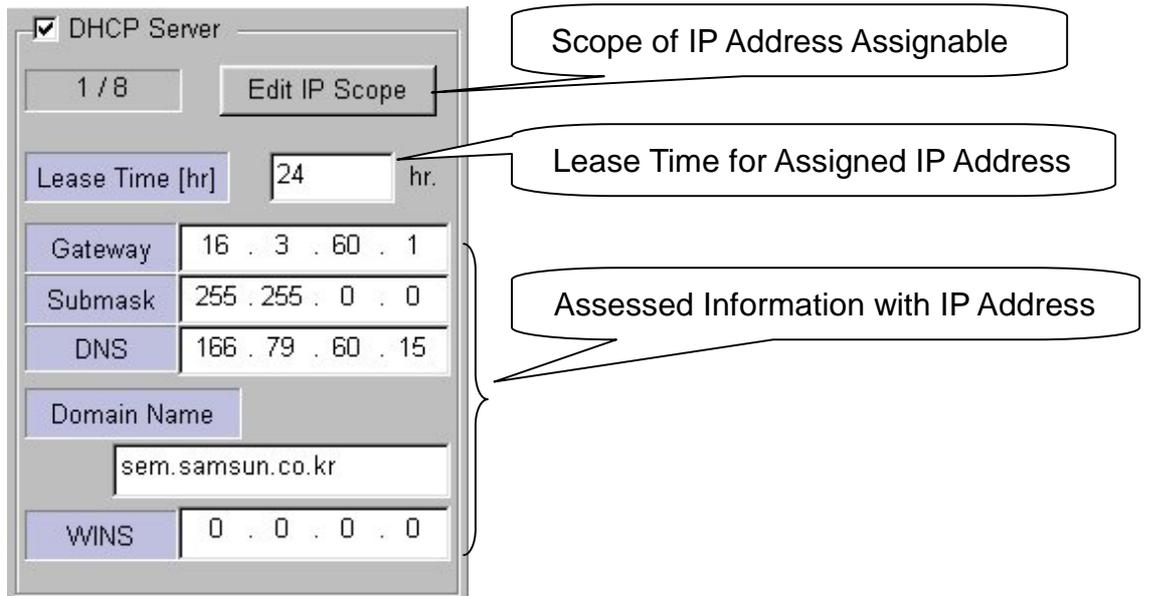

**Notice** : When you select DHCP Server, the values on the window show information assigned to DHCP Client with IP Address. In most cases, values of “Gateway” and “Submask” are same as those of Gateway and Submask of current AP.

- ④ Click [Edit IP Scope] button, and the window below will appear.

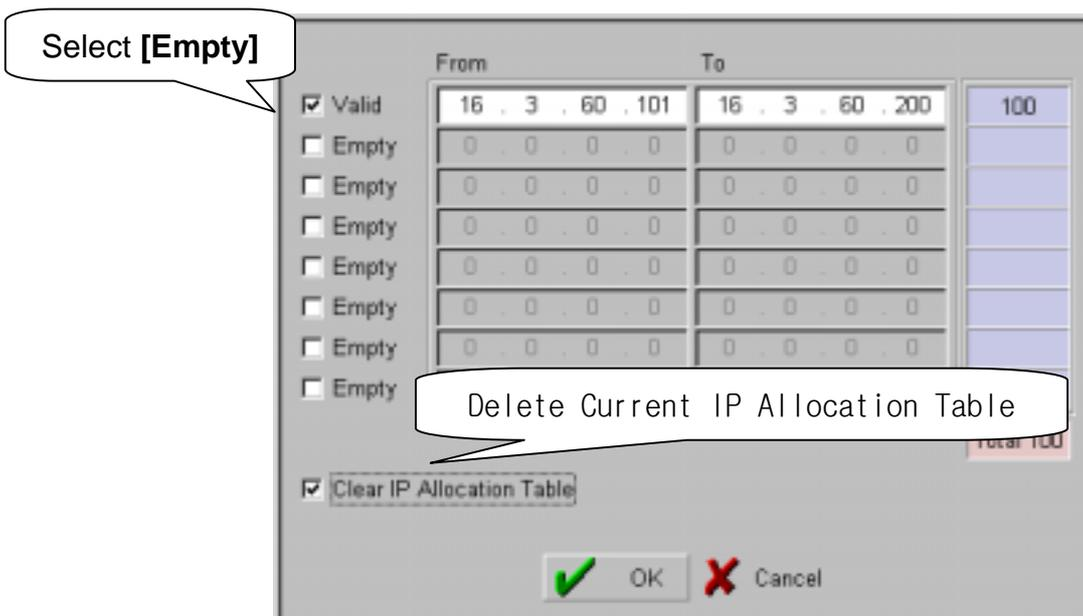

- ⑤ To set the scope of assignable IP Address, first check on [Empty] check box on the left. Then, “Empty” will be changed to “Valid”, and you can set the scope.
- ⑥ Enter the beginning value in “From”, and ending value in “To”.
- ⑦ When you complete to set the scope of assignable IP Address, click [Clear IP Allocation Table] button to current “Allocation Table”. Then, click [OK] button.
- ⑧ When you click [Confirm & Apply] button to apply new configuration, “Configuration Summary” window, which shows new configuration, will appear.

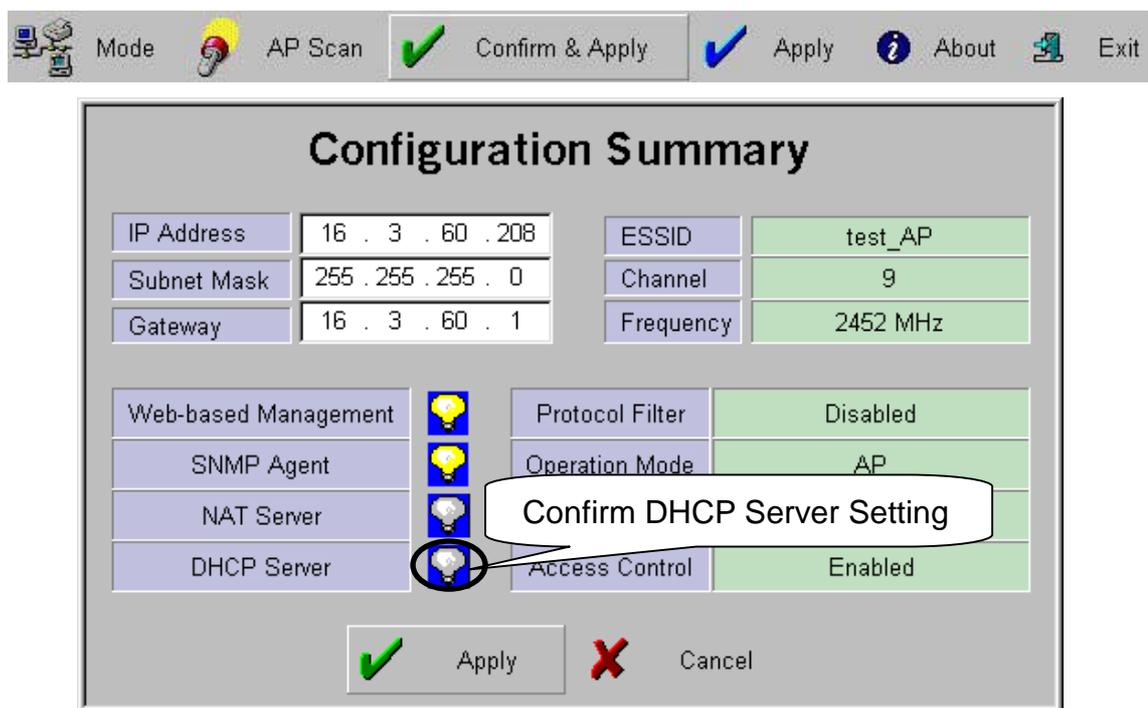

- ⑨ If new settings are entered correctly, click [Apply] button to apply new configuration.
- ⑩ When you click [Apply] button, “Password” window will appear.

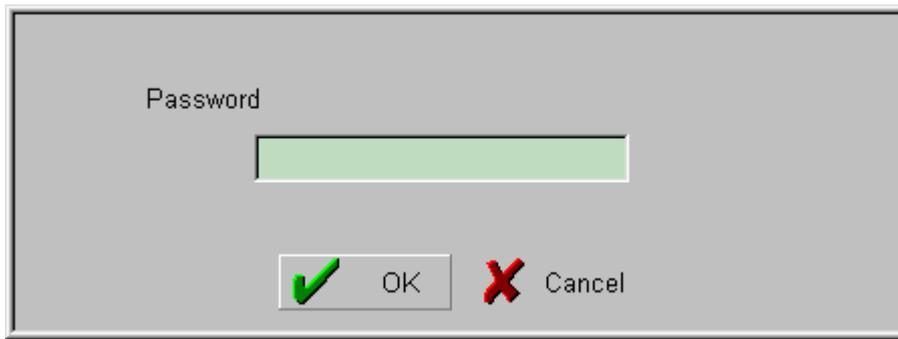

- ⑪ After you enter the password, click [OK] button.
- ⑫ When you click [Apply] button instead of [Confirm & Apply] button, “Password” window will appear immediately skipping “Configuration Summary” window. After you enter the password, click [OK] button to apply new configuration.
- ⑬ After rebooting, choose selected proper AP on “List Box”. Then, the selected AP set with DHCP Server can be confirmed on [Selected AP’ s Info] Group Box as shown below.

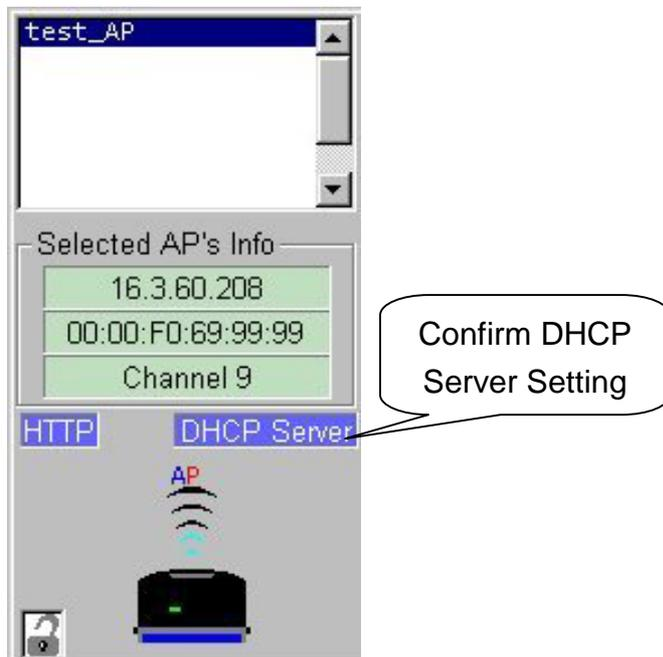

**Notice** : If you want to set DHCP Client instead of DHCP Server, select [Basic] on “Tab Bar” menu of AP. Then, select “Obtain an IP address automatically” from Dialogue Box. (Refer to step of Chapter6.) Then, the selected AP gives up its own IP Address, and other AP using DHCP Server will assign it. When the setting is completed, click [Confirm & Apply] or [Apply] button to apply new configuration.

In case of DHCP connection with desktop or notebook PC of user to AP using DHCP Server, select “Obtain an IP address automatically” on “TCP/IP Properties”. Please refer step of Chapter10.

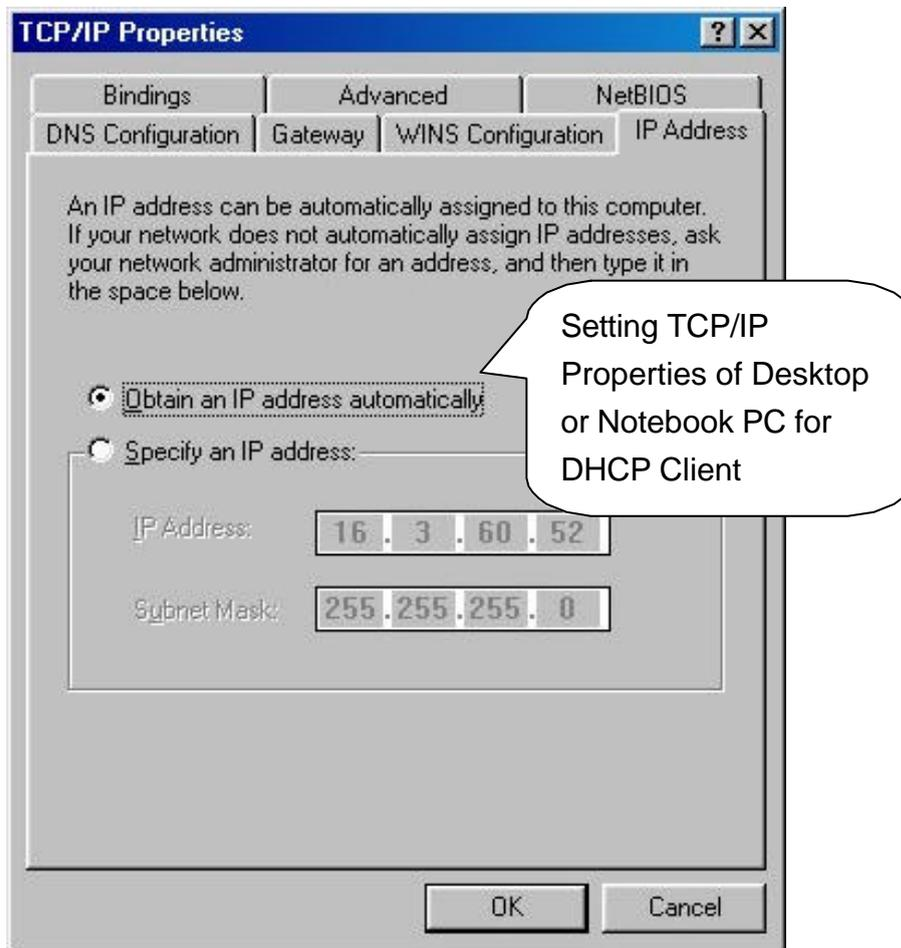

## 9. NAT and DHCP Server Simultaneous Setting Using AP Manager

- ① After executing AP Manager, select [Server] tab on “Tab Bar” to set DHCP Server and NAT simultaneously.
- ② Please refer to Chapter 10 for NAT Setting and Chapter 11 for DHCP Server Setting. This chapter shows default values.

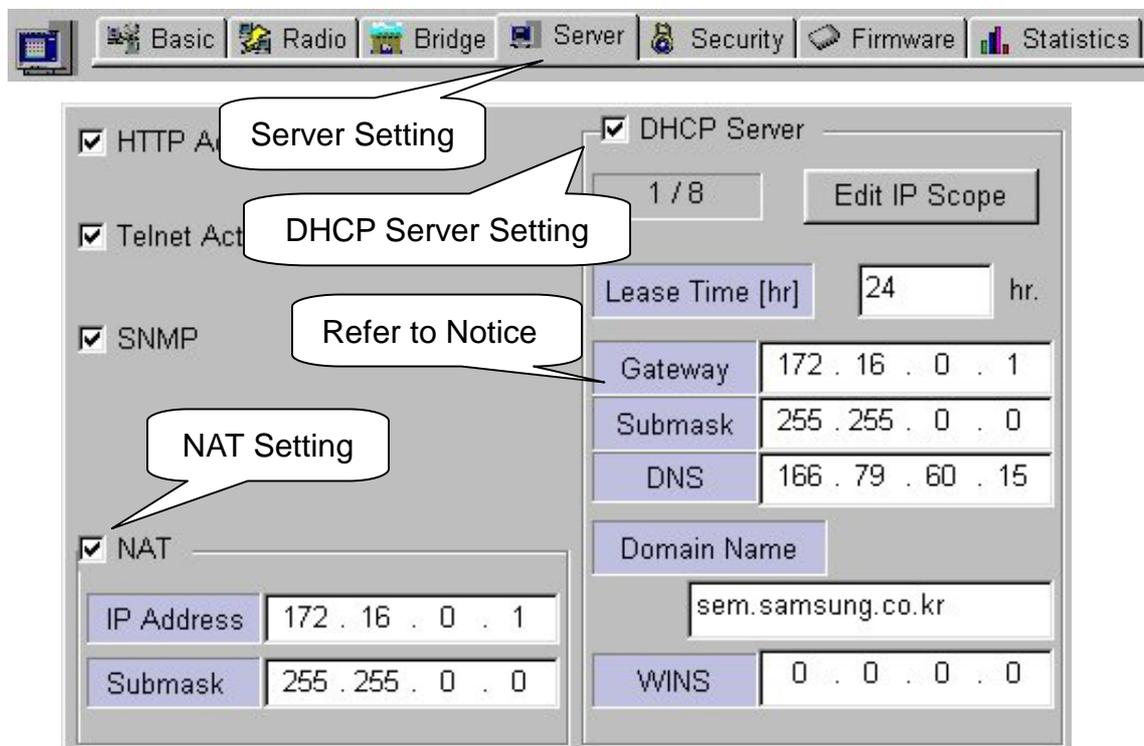

**Notice :** In this case, IP Address as Gateway format in NAT Setting must be set for Gateway of DHCP Server Setting.

- ③ When you click [Confirm & Apply] button to apply new configuration, “Configuration Summary” window, which shows new configuration, will appear.

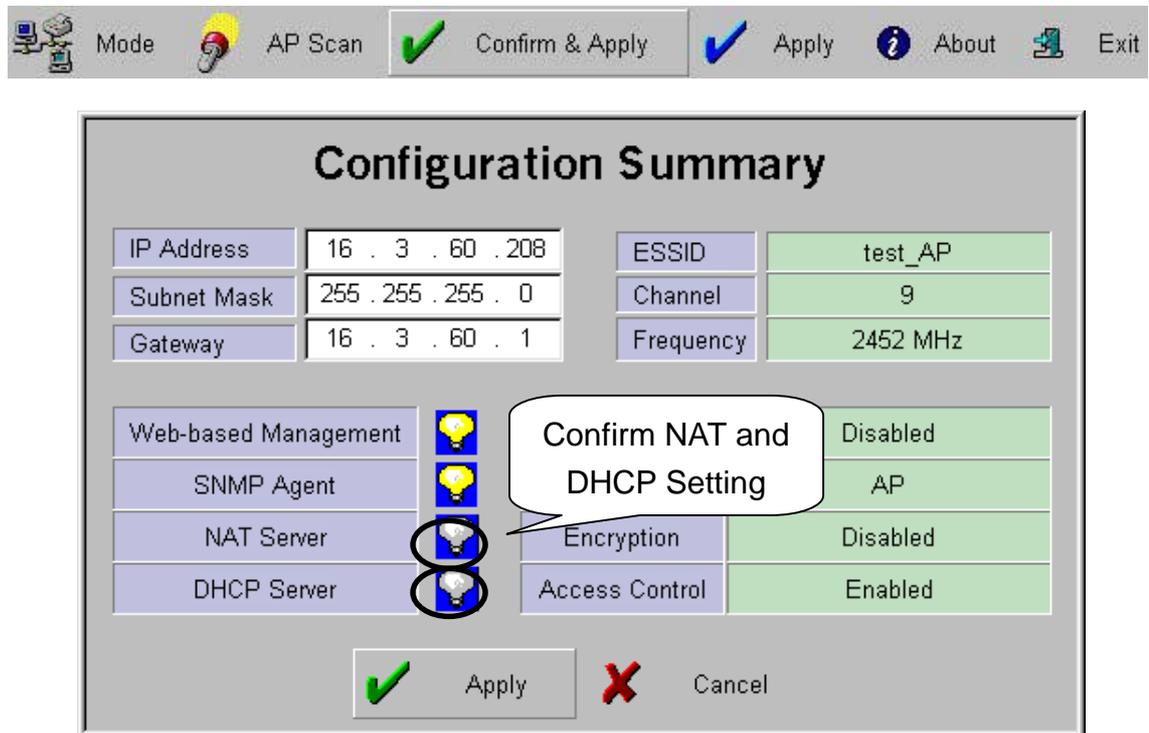

- ④ If new settings are entered correctly, click [Apply] button to apply new configuration.
- ⑤ When you click [Apply] button, “Password” window will appear.



- ⑥ After you enter the password, click [OK] button.

- ⑦ When you click [Apply] button instead of [Confirm & Apply] button, “Password” window will appear immediately skipping “Configuration Summary” window. After you enter the password, click [OK] button to apply new configuration.
  
- ⑧ After rebooting, choose selected proper AP on “List Box”. Then, the selected AP set with NAT and DHCP Server can be confirmed on [Selected AP’ s Info] Group Box as shown below.

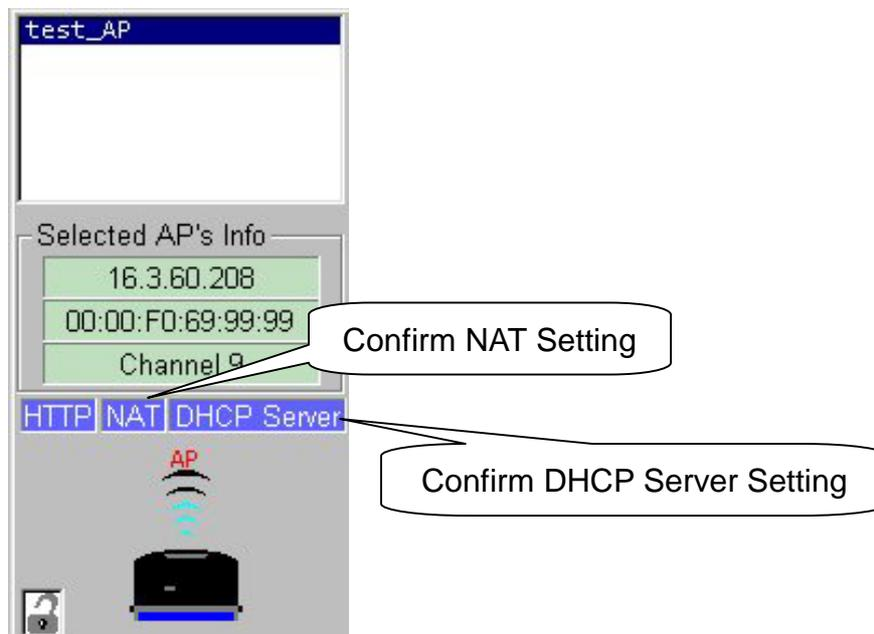

## 10. ADSL and Cable Modem Connection Setting Using AP Manager

- ① After executing AP Manager, click [Advanced] and [Internet Connection] on “Menu Bar” in the following order. Or click [Internet Connection] button on [Basic] Dialogue Box.

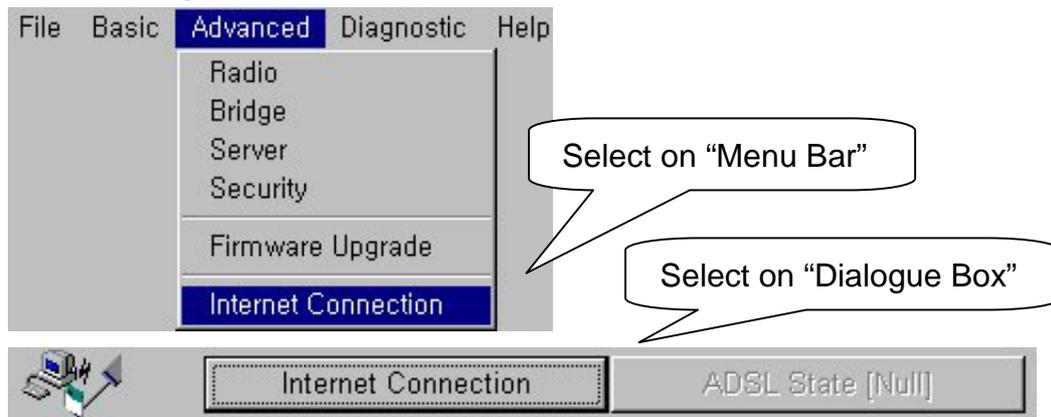

- ② Then the Internet Connection Setup page(default page) will appear.  
Select your Internet connection service type and click

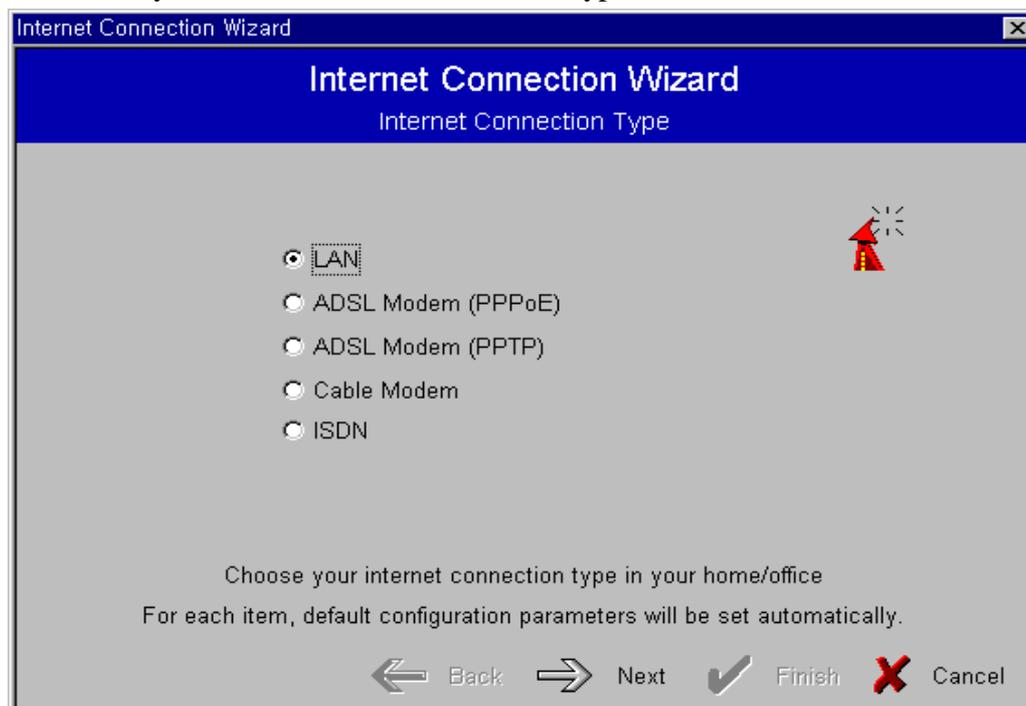

**Notice:** ADSL can generally be divided into two service types supporting PPPoE or PPTP, but PPPoE is more common. If you don't know your ADSL service type, please check the Website or contact your ISP to find out service type you are using.

- ③ Go to 10.1 for PPPoE, 10.2 for PPTP, and 10.3 for Cable Modem

## 10.1 Settings for ADSL – PPPoE

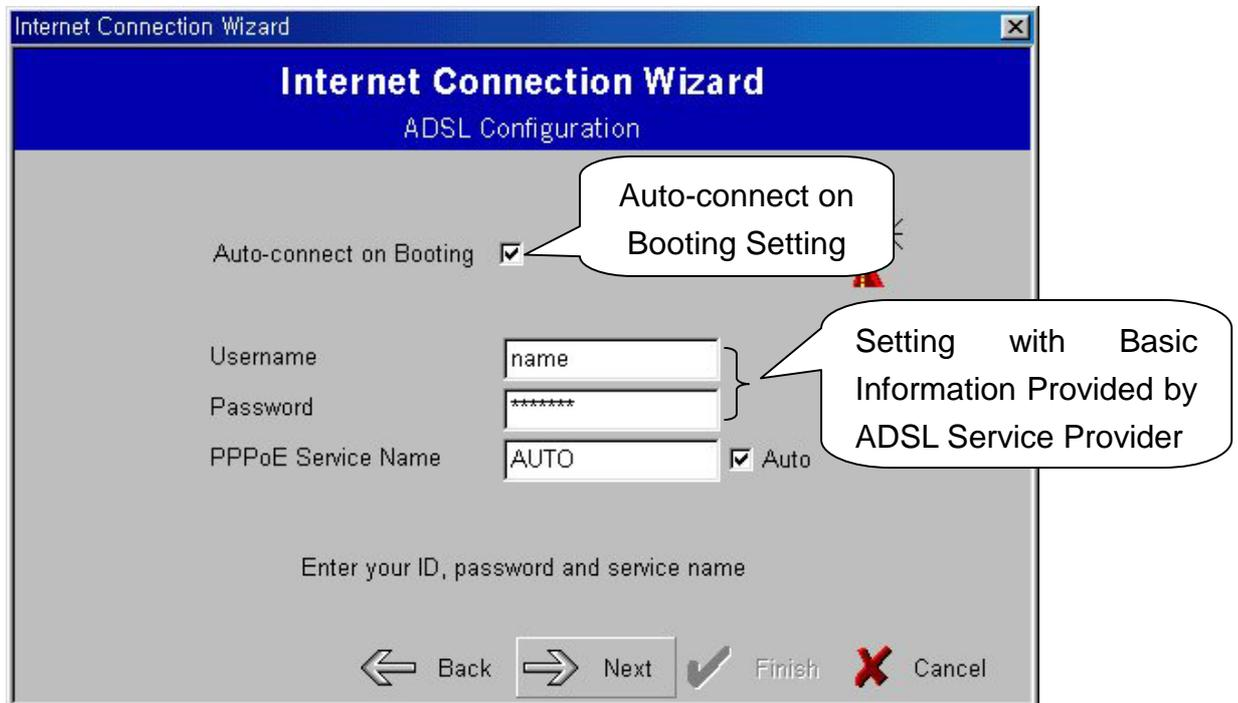

- ① When the above page appears, enter the user name given by your ISP(Internet Service Provider) in the “User Name” box.
- ② Enter the password in the “Password” box.

**Notice:** If PPPoE service name setting is not selected for Auto, PPPoE service name will be required

- ③ Set NAT and DHCP Server referring Chapter 9.

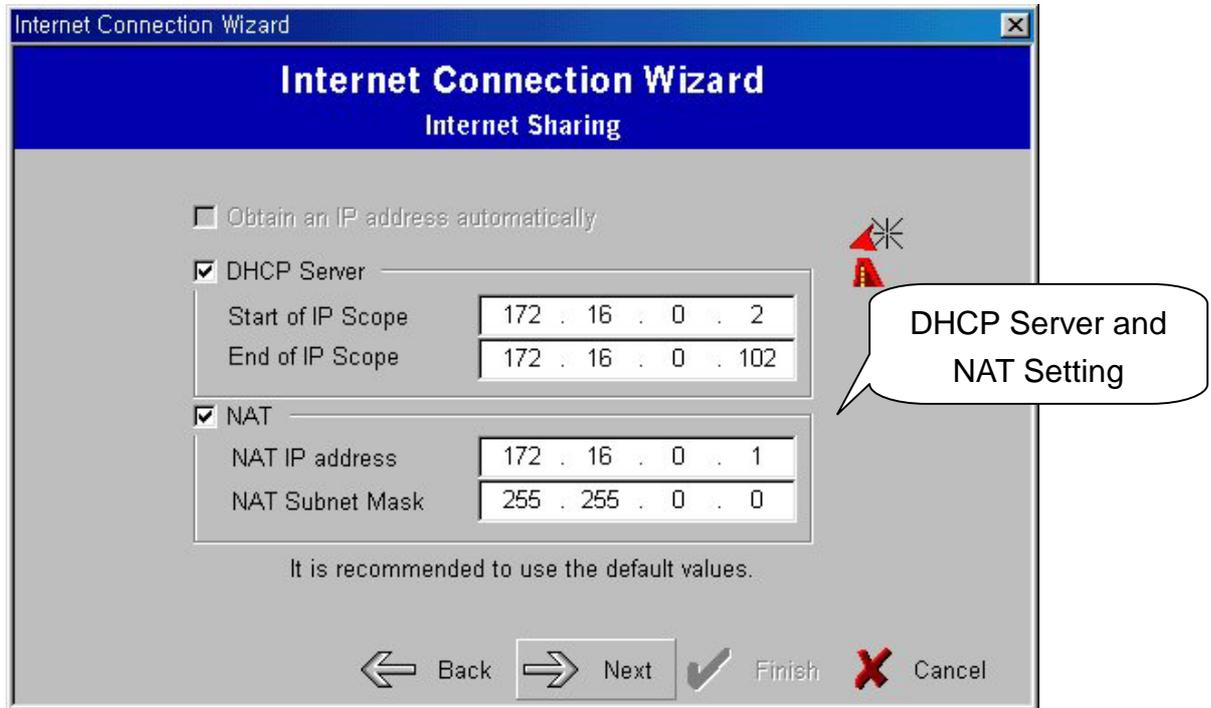

- ④ Click [Finish] button to complete setting.



- ⑤ A window will appear and ask you to apply new settings immediately. If you do not want to apply new settings, select [No(N)].



- ⑥ If you click [Yes(Y)] button, “Password” window will appear. After you enter the password, click [OK] button to apply. In case you select [No(N)] button, new settings will be saved. If you want to continue applying procedure again, click [Apply] button on “Button Bar”.
- ⑦ When you click [Basic] tab on “Tab Bar,” ADSL Connection Status will appear in Dialogue Box. The connection status will show “N/A” for Access Point and “Connected”, “Disconnected” and “Negotiating” for ADSL Setting.

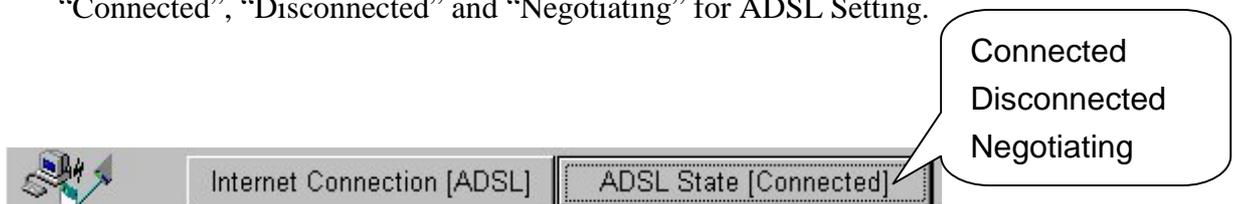

- ⑧ Clicking [ADSL State(Connected, Disconnected, Negotiating)] button enables you to disconnect. On the other hand, when you click the button while it is disconnected, you can re-connect according to selected information.

## 10.2 Settings for ADSL – PPTP



The screenshot shows the 'Internet Connection Wizard' window with the 'ADSL Configuration' tab selected. The window has a blue header bar with the title 'Internet Connection Wizard' and 'ADSL Configuration'. Below the header, there are several fields and options:

- 'Auto-connect on Booting' is checked with a small square icon.
- 'Username' field contains the text 'name'.
- 'Password' field contains seven asterisks '\*\*\*\*\*'.
- 'PPTP Server IP Address' field contains the IP address '10 . 0 . 0 . 1'.

At the bottom of the window, there is a navigation bar with four buttons: 'Back' (left arrow), 'Next' (right arrow), 'Finish' (checkmark), and 'Cancel' (red X). A warning icon (a red triangle with a lightning bolt) is visible on the right side of the window.

- ① When the above page appears, enter the user name given by your ISP(Internet Service Provider) in the “User Name” box.
- ② Enter the password in the “Password” box.
- ③ Enter the IP Address of PPTP Server in the “PPTP Server IP Address” box

**Notice:** *In case IP Address of PPTP Server are unknow, contact your ISP.*

- ④ Set NAT and DHCP Server referring Chapter 9.

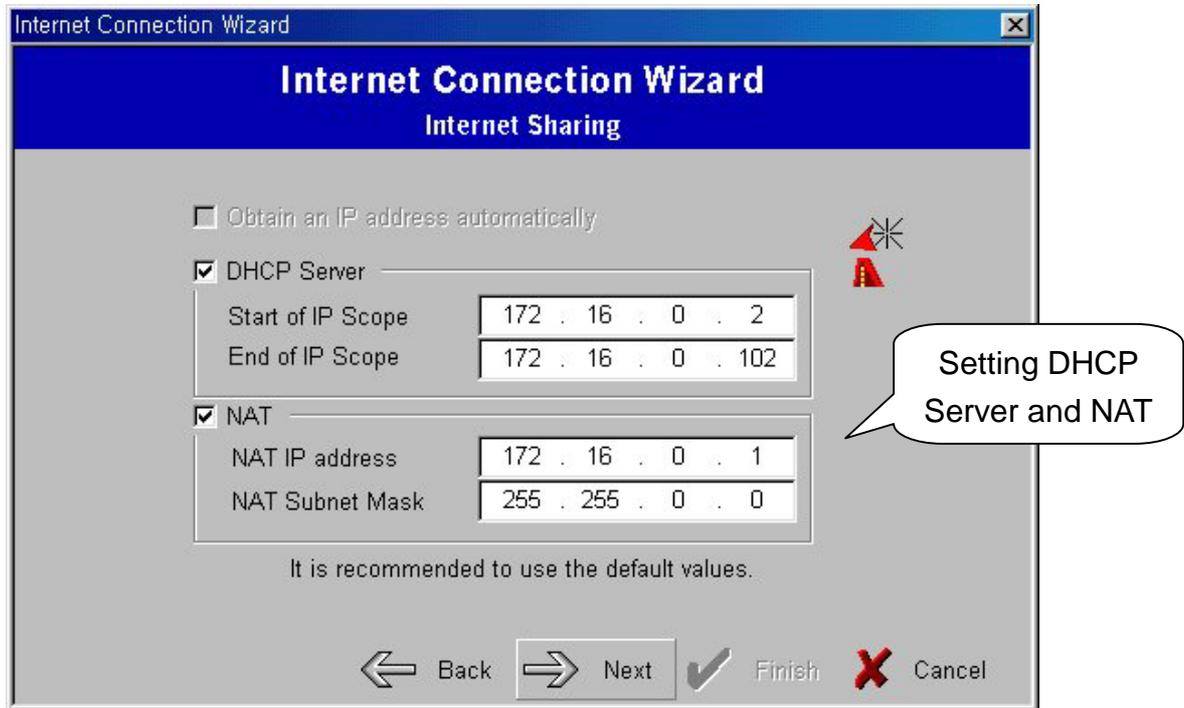

- ⑤ Click [Finish] button to complete setting.

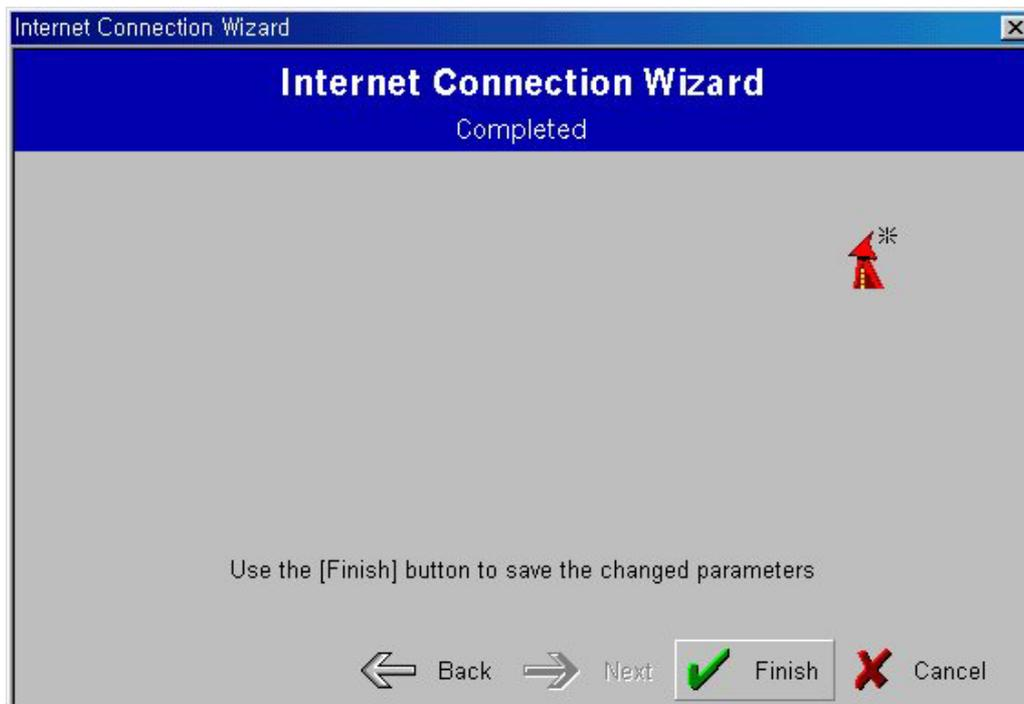

- ⑥ A window will appear and ask you to apply new settings immediately. If you do not want to apply new settings, select [No(N)].



- ⑦ If you click [Yes(Y)] button, “Password” window will appear. After you enter the password, click [OK] button to apply. In case you select [No(N)] button, new settings will be saved. If you want to continue applying procedure again, click [Apply] button on “Button Bar”.
- ⑧ When you click [Basic] tab on “Tab Bar,” ADSL Connection Status will appear in Dialogue Box. The connection status will show “N/A” for Access Point and “Connected”, “Disconnected” and “Negotiating” for ADSL Setting.

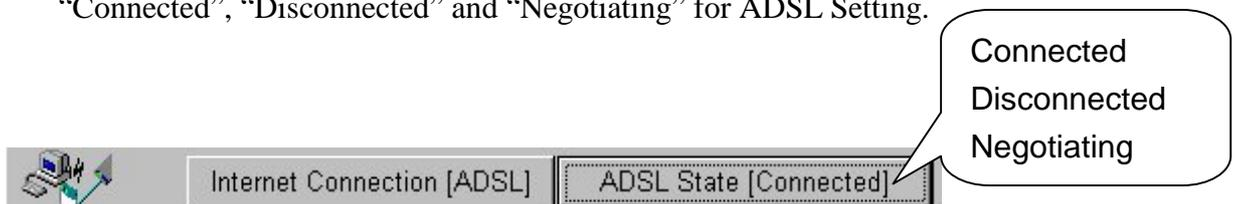

- ⑨ Clicking [ADSL State(Connected, Disconnected, Negotiating)] button enables you to disconnect. On the other hand, when you click the button while it is disconnected, you can re-connect according to selected information.

## 10.3 Settings for Cable Modem

- ① Set NAT and DHCP Server referring Chapter 9.

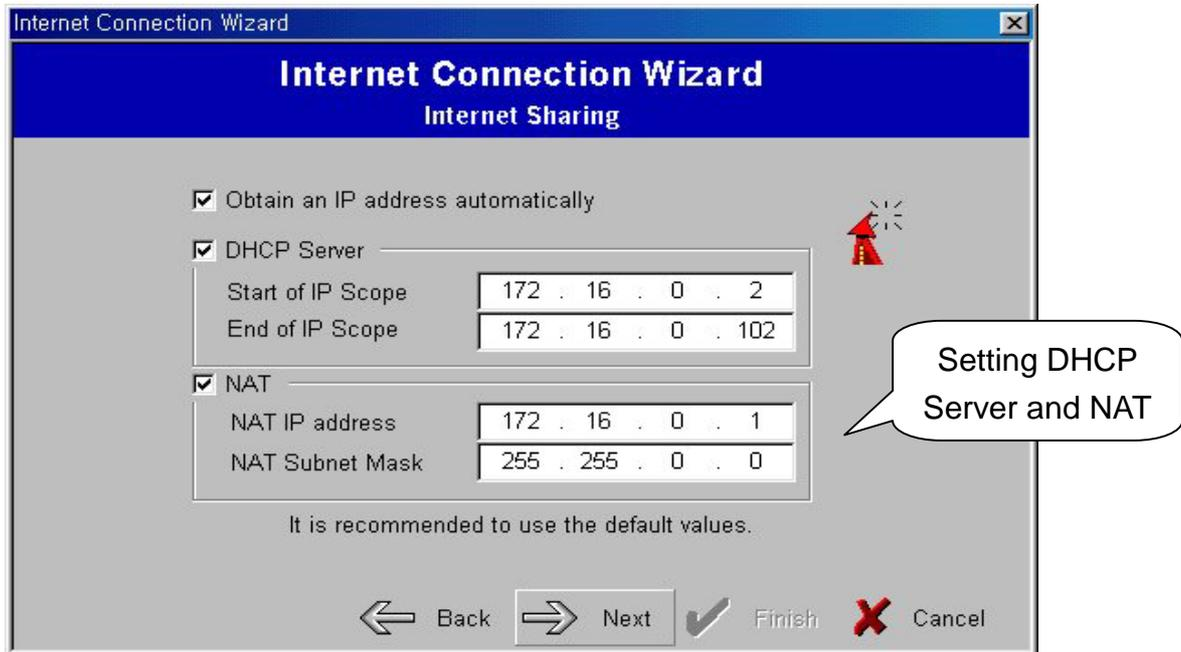

**Notice** : *Personal Information Setting is not needed because Cable modems are generally given with fixed IP Address.*

- ② Click [Finish] button to complete setting.



- ③ A window will appear and ask you to apply new settings immediately. If you do not want to apply new settings, select [No(N)].

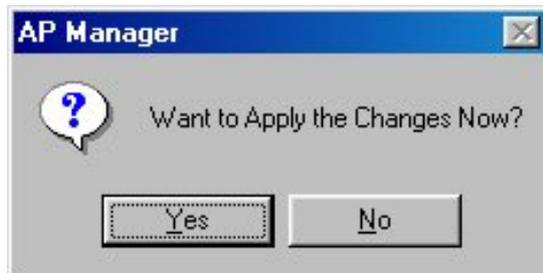

- ④ If you click [Yes(Y)] button, "Password" window will appear. After you enter the password, click [OK] button to apply. In case you select [No(N)] button, new settings will be saved. If you want to continue applying procedure again, click [Apply] button on "Button Bar".

## 11. Encryption Setting Using AP Manager

- ① After executing AP Manager, select [Security] tab on “Tab Bar” to set encryption. Then, select “Encryption”.



- ② Select either “64(40)-bit Key” or “128-bit Key.” The window below shows “64(40)-bit Key” setting.



- ③ When you select [Set WEP Key] button, a window for WEP Key generation is created as shown below.

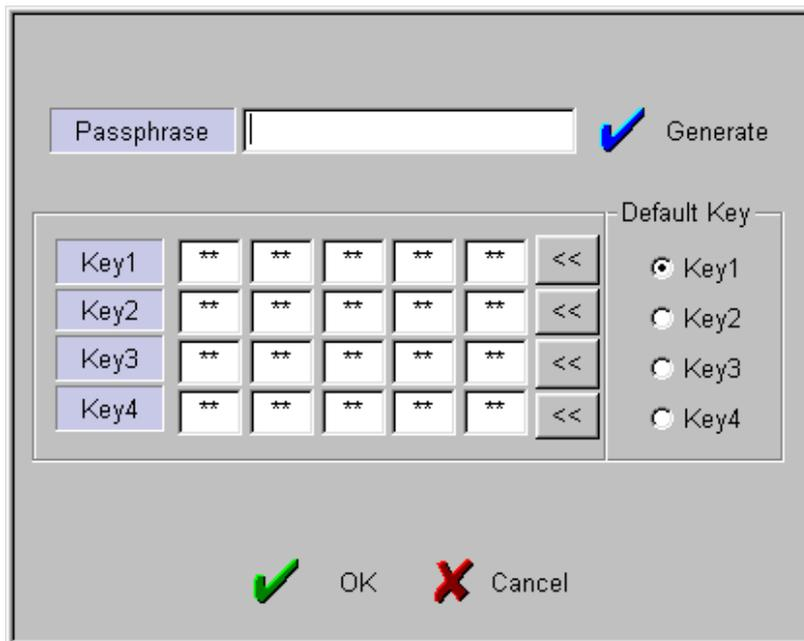

- ④ Enter the agreed password phrase to set encryption in “Passphrase,” and click [Generate] button to create WEP Key.

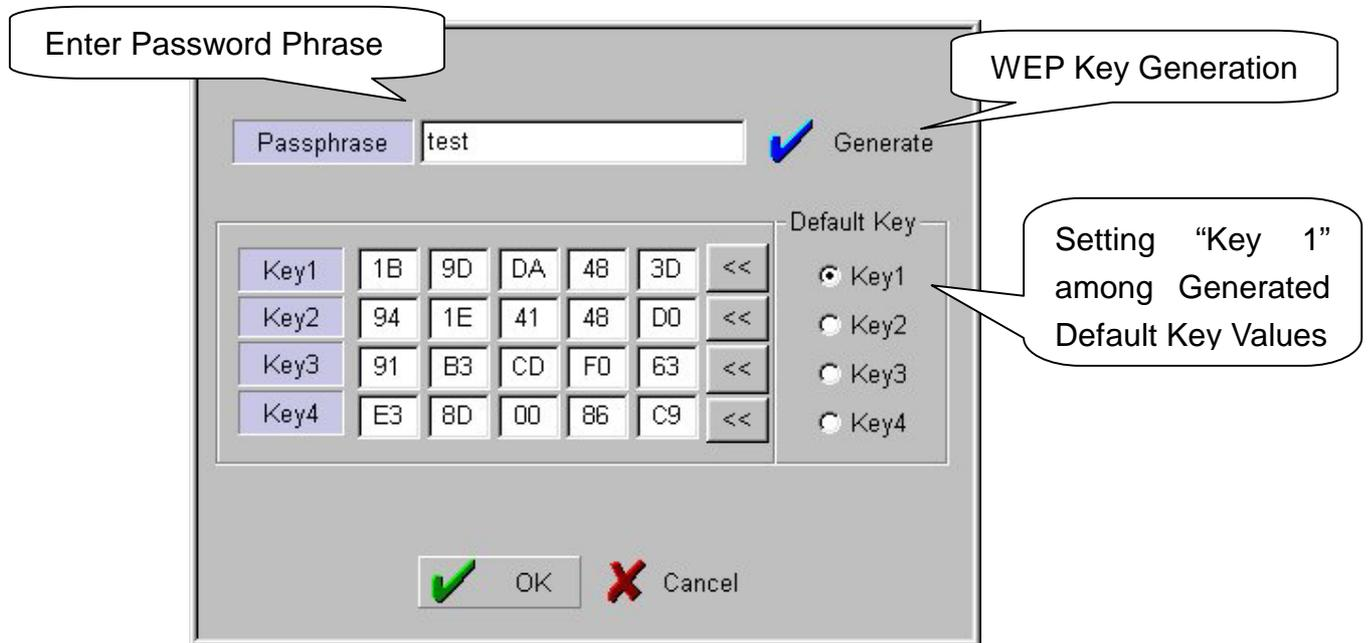

After generating the keys, select one key among “Default Key”s. Click [OK] button to complete setting of the key to be used for encryption.

**Notice :** *In this case, WEP Keys should be generated using same Passphrase for Card Utility of desktop and notebook PC. Select same key, which is also selected by AP, among generated WEP Keys for “Default Key” value.*

- ⑤ When you click [Confirm & Apply] button to apply new configuration, “Configuration Summary” window, which shows new configuration, will appear.

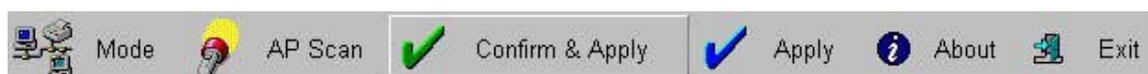

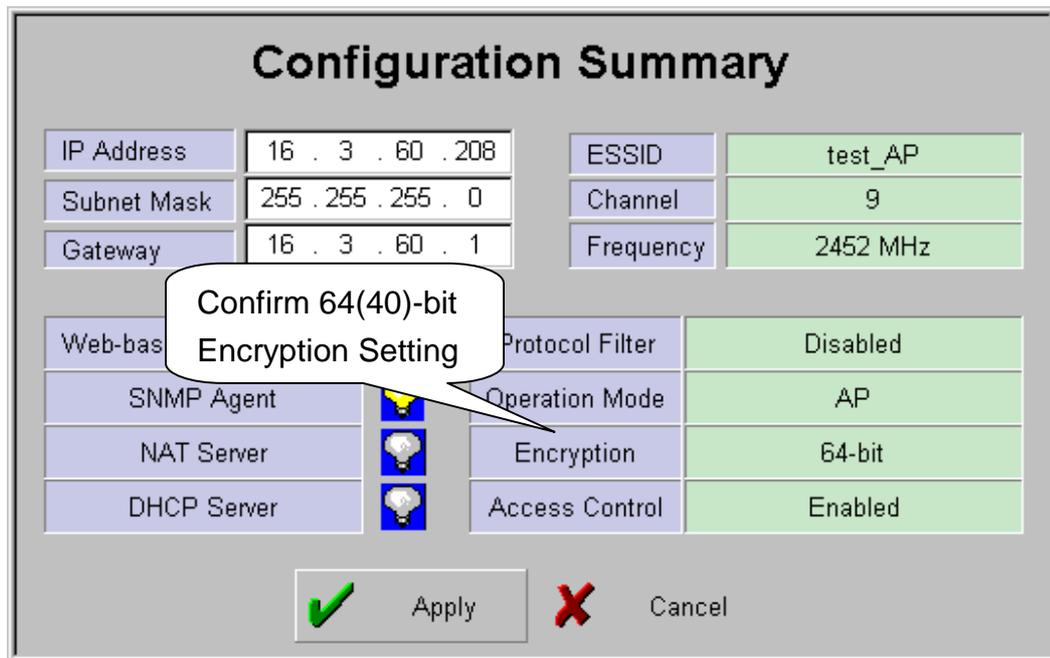

- ⑥ If new settings are entered correctly, click [Apply] button to apply new configuration.
- ⑦ When “Password” window appear, enter the password. Then click [OK] button.
- ⑧ After rebooting, choose selected proper AP on “List Box”. Then, the selected AP set with Encryption can be confirmed on [Selected AP’ s Info] Group Box as shown below.



- ⑨ Change configuration of Card Utility(installed Wireless LAN Card) of desktop or notebook PC, which is wanted to connect to AP with Encryption setting. For the configuration of Card Utility, refer to User Guide of your LAN Card

## 12. User Access Control Setting Using AP Manager

- ① “User Access Control” is function that shows permission of using AP to MAC ID Table of Wireless LAN Card installed on certain Stations among desktop or notebook PC, which are connected AP. If you want to use this function, select “User Access Control” on [Security] Dialogue Box.

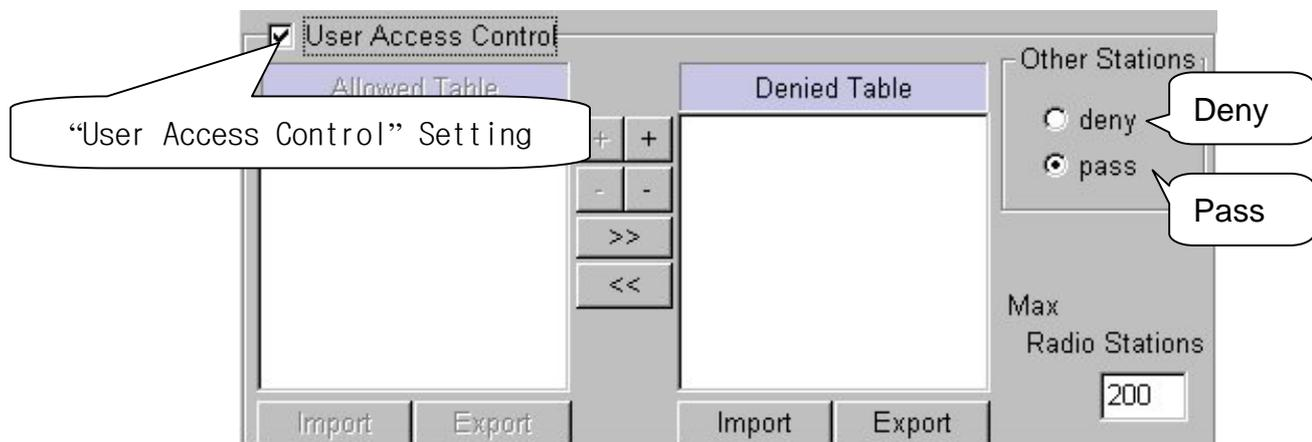

- ② The selections of [Other Stations] are common setting to decide whether deny or pass connection of Stations other than selected and managed by user.
- ③ When you permit connection to selected AP, enter MAC ID of Wireless LAN Card on [Allowed Table]. Otherwise, enter MAC ID on [Denied Table]. All settings of the other MAC ID other than entered MAC IDs in each table are set by selecting “deny” or “pass” on [Other Stations] Box.
- ④ When MAC ID is added on each table, use [+] icon. On the other hand, when deleted, use [-] icon.
- ⑤ When you want to permit specific MAC ID and deny the other, select “deny” on [Other Stations] Box. Then, enter the MAC ID on [Allowed Table], which is you want to permit.

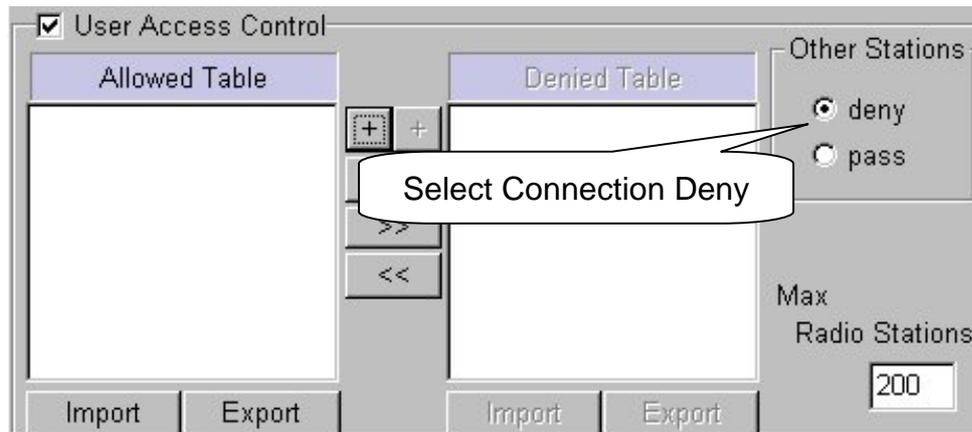

Click [+] icon, and enter MAC ID as shown on the window below. Then, click [OK] button to add MAC ID on [Allowed Table].

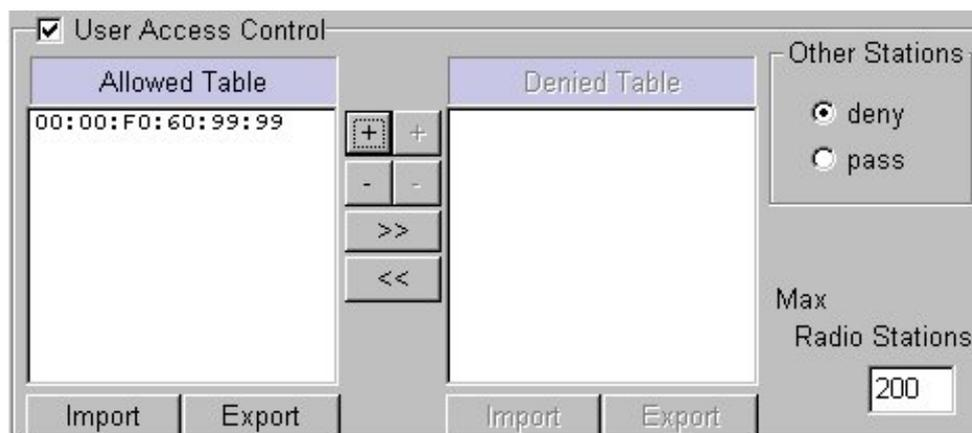
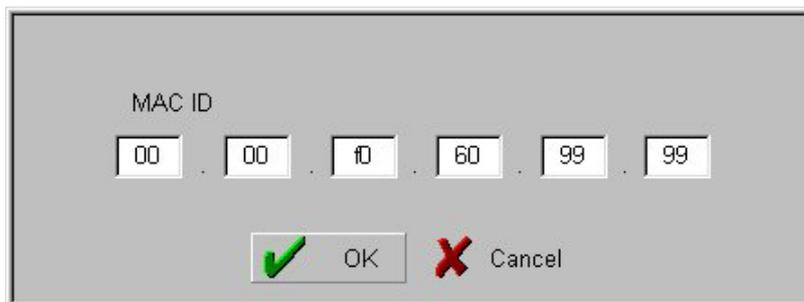

- ⑥ When you want to deny specific MAC ID and permit the other, select “pass” on [Other Stations] Box. Then, add the MAC ID on [Denied Table], which is you want to deny. MAC ID can be entered by the method explained on ⑤ and also move MAC ID from [Allowed Table].
- ⑦ To move MAC ID from [Allowed Table] to [Denied Table], use [>>] icon. Otherwise, use [<<] icon.
- ⑧ After select “pass” on [Other Stations] Box, move MAC ID from [Allowed Table] to [Denied Table] using [>>].

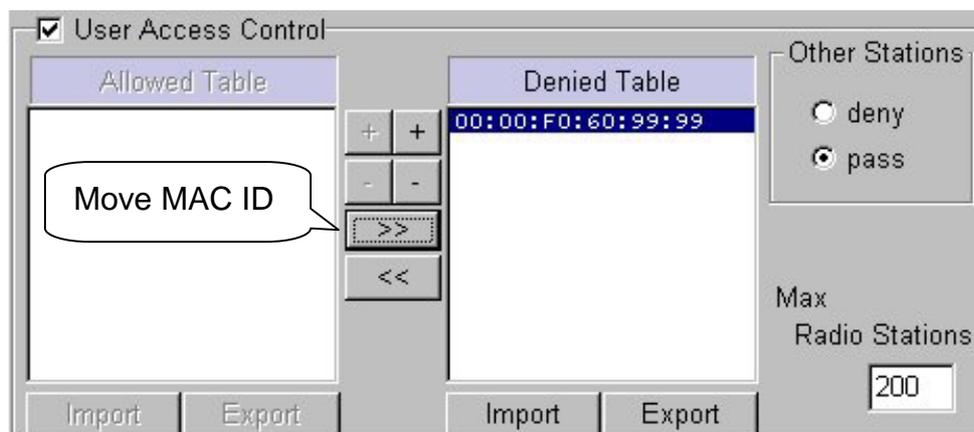
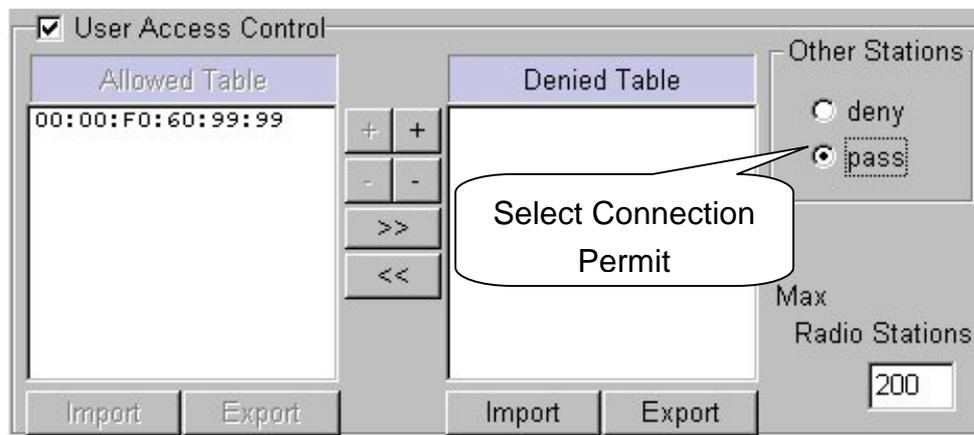

⑨ If you want to export and save MAC IDs registered either on [Allowed Table] or [Denied Table], click [Export] button. Then, it will be saved where user wants as “granted.lst” or “denied.lst”. You can rename the file name.

- granted.lst -> MAC ID List on [Allowed Table]
- denied.lst -> MAC ID List on [Denied Table]

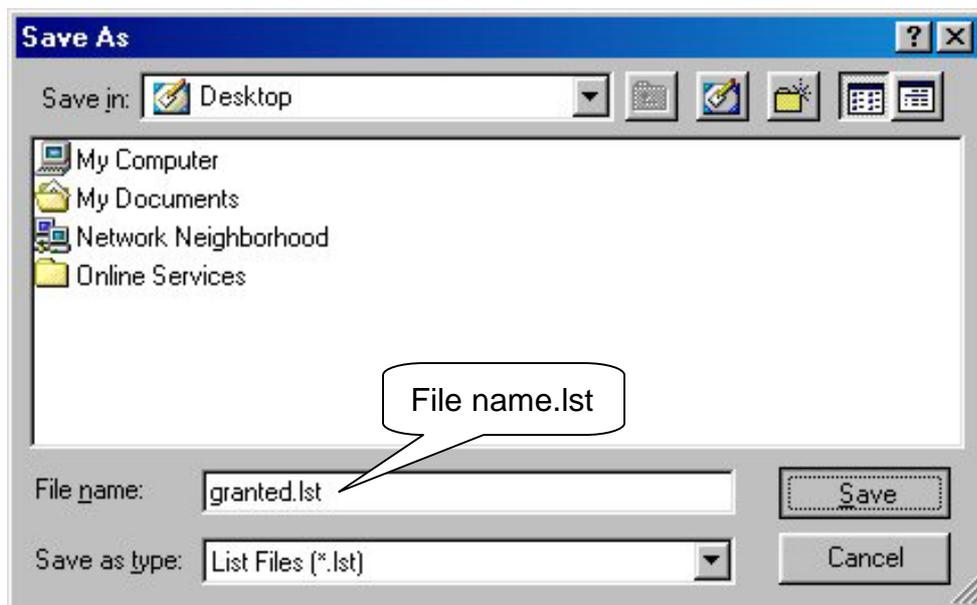
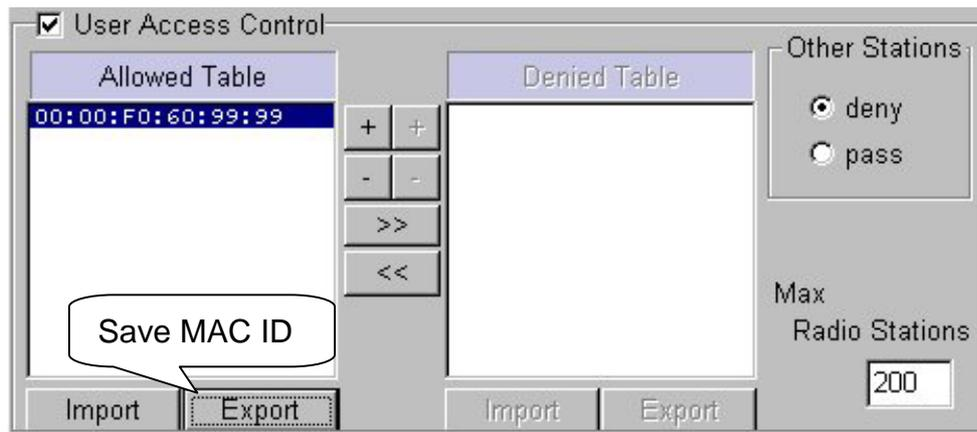

On the other hand, click [Import] button to import saved MAC ID Lists.

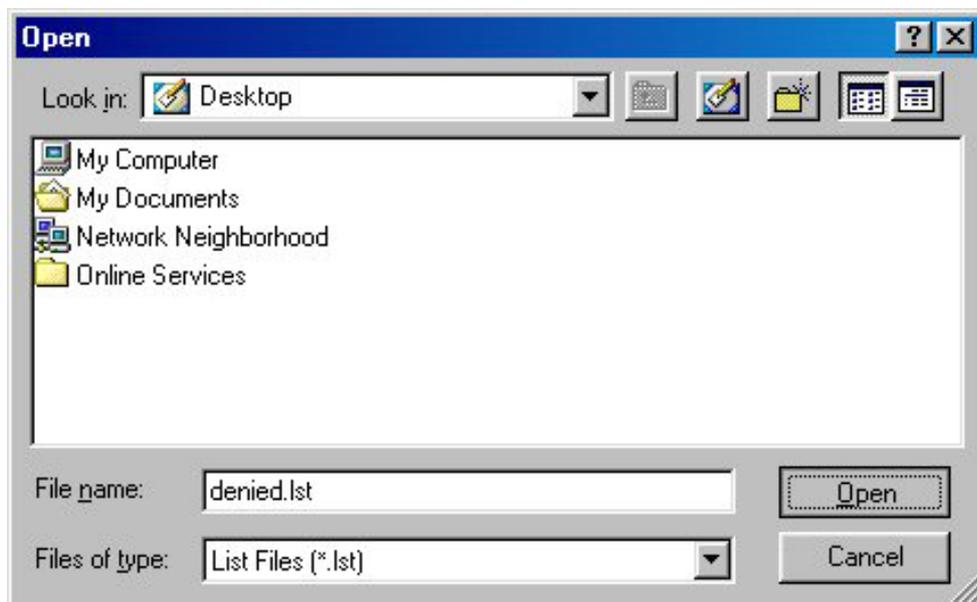
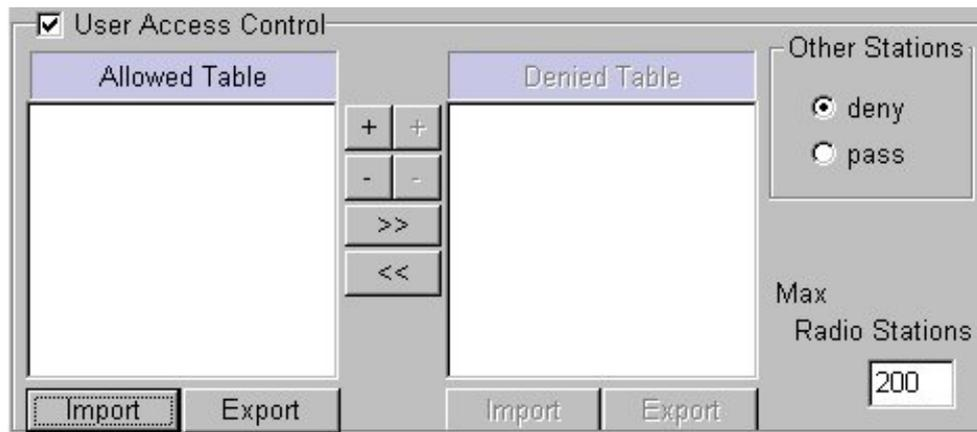

- ⑩ You can combine and use various settings as you wish.
- ⑪ If new settings are entered correctly, click [Apply] button to apply new configuration.
- ⑫ When “Password” window appear, enter the password. Then, click [OK] button.

## 13. Firmware Upgrade Using AP Manager

- ① Whenever the new version of AP Firmware is available, you can upgrade AP firmware into higher version using AP Manager.
- ② After executing AP Manager, select [Firmware] tab on “Tab Bar”.



- ③ Dialogue Box of the Firmware upgrade is like what is view in the window below.

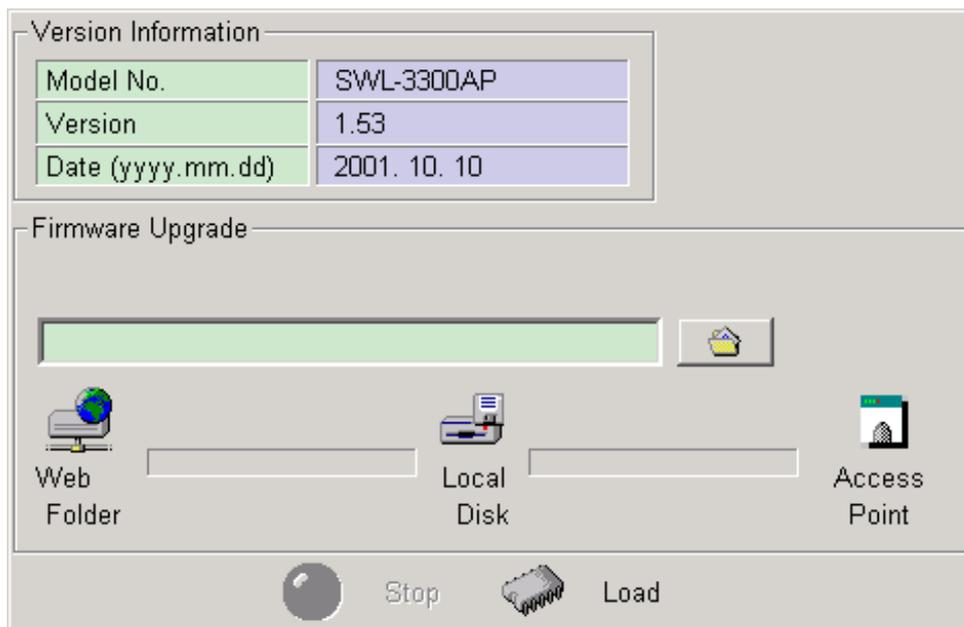

- ④ The current firmware information of the selected AP is displayed in the [Version Information] Box as shown in the window below.

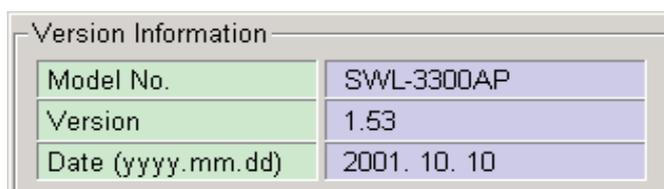

- ⑤ Downloaded the latest version of AP firmware in local disk of your PC

**Notice:** AP firmware corresponding to your AP can be downloaded in MagicLAN home page.

- ⑥ Click the file icon shown below on Dialogue Box.



- ⑦ After select the firmware image file, click [Open] button.

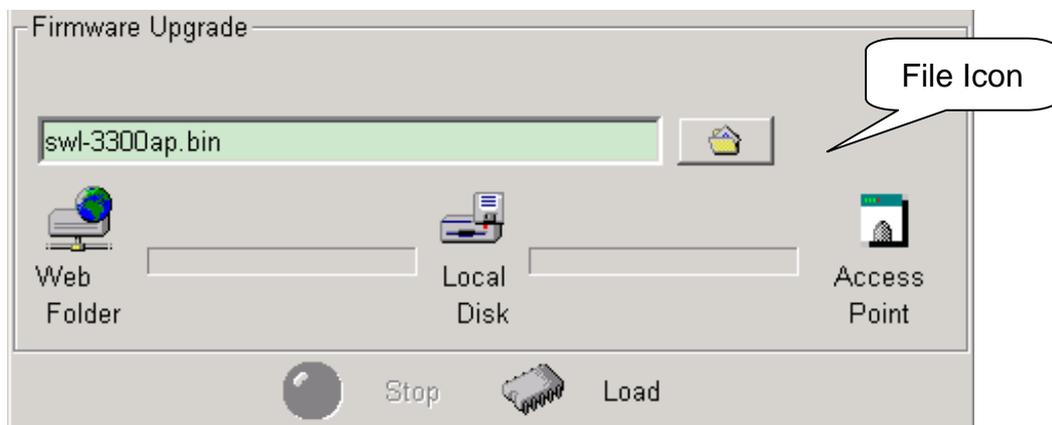
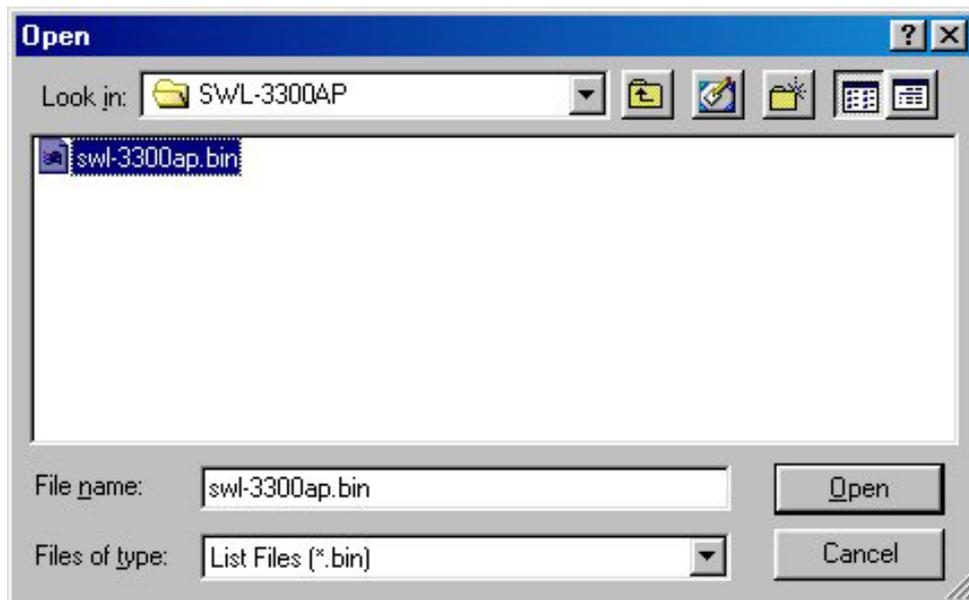

- ⑧ Click the [Load] button after the file is selected. Then, “Password” window will be displayed.

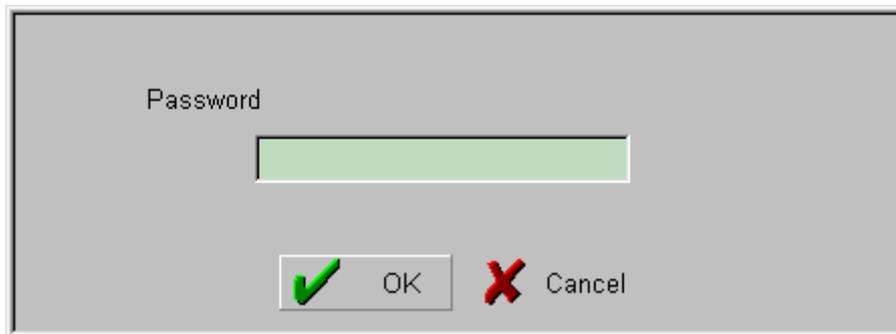

- ⑨ Enter the password, default password is “public”, and click [OK] button.

The AP firmware is loaded from your Local Disk to the Access Point and is upgraded. The following window shows the status of loading the AP firmware image file to the AP.

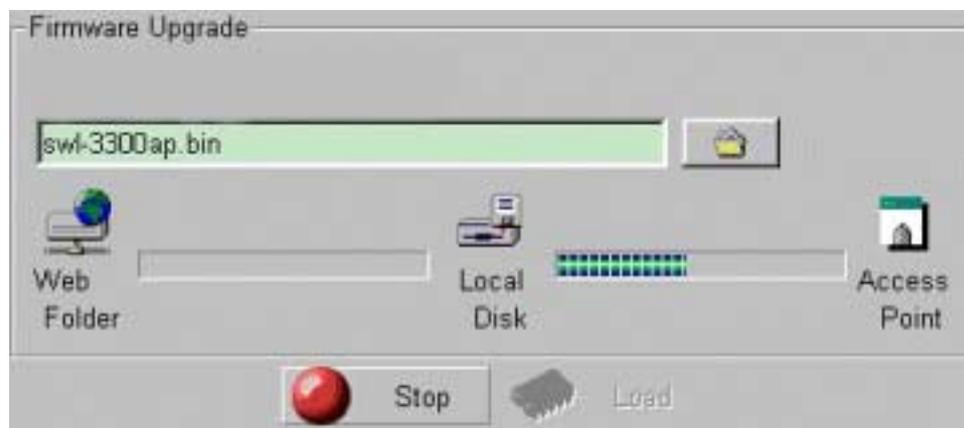

Click the [Stop] button to cancel the download of AP firmware at any time.

An error message will show up if AP firmware other than you select is downloaded.

## 14. Data Transmission Status Check Using AP Manager

- ① Data transmission traffic status of current AP can be confirmed using AP Manager.
- ② When [Statistics] tab on “Tab Bar” of AP Manager is selected, a window, which shows [Traffic Selection] Box on Dialogue Box to select Traffic type and shows related information below, will appear.

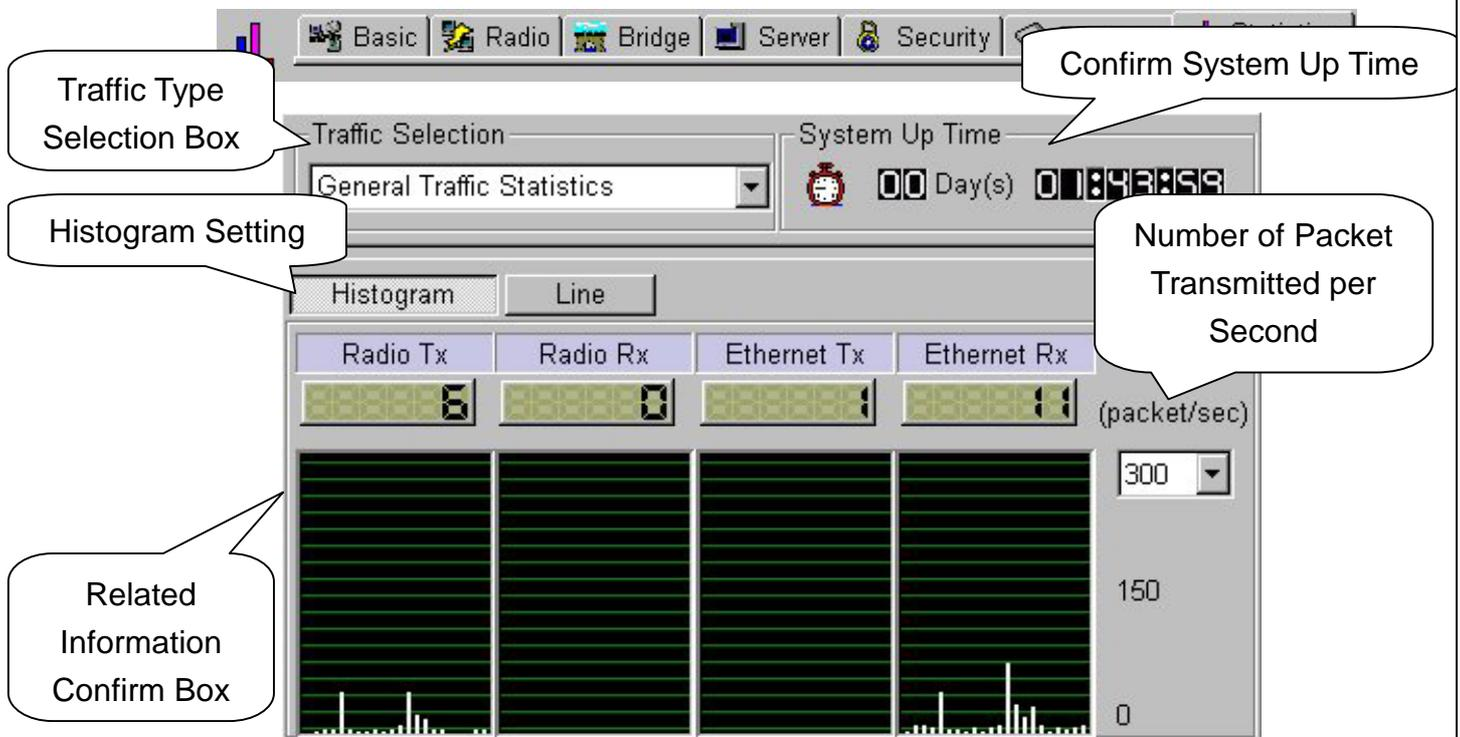

- ③ [System Up Time] Box informs operation time since starting of selected AP operation.
- ④ When selecting “General Traffic Statistics” on [Traffic Selection] Box, wired and wireless data transmission status can be shown with line or histogram graph on Related Information Confirm Box.

- ⑤ If you want to confirm with line graph, select “Line” instead of “Histogram” on Related Information Confirm Box.

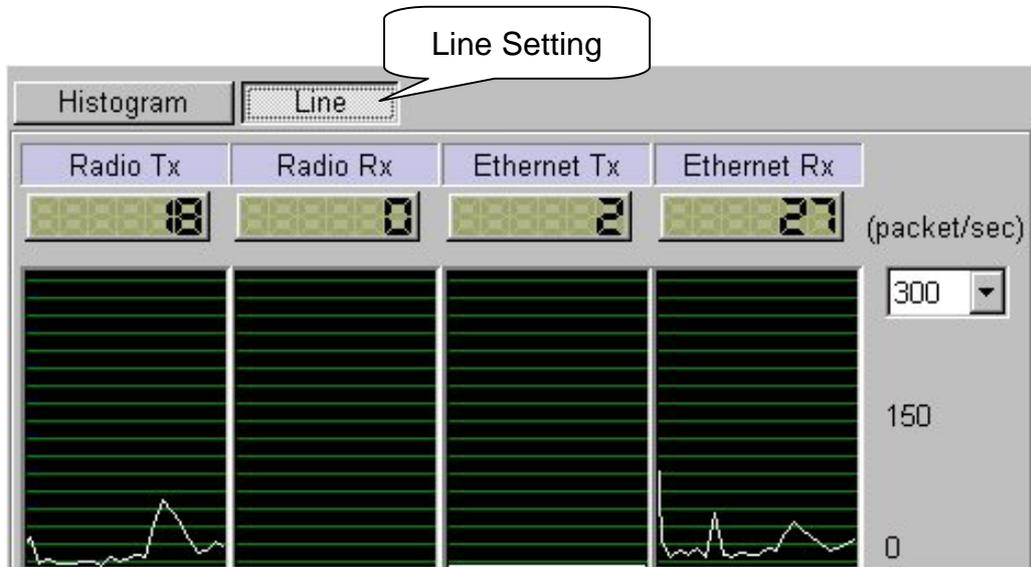

- ⑥ In this case, if confirm is impossible due to increased number of packets with wired and wireless transmission, increase scope of number of packet transmitted per second(packet/sec) to confirm.

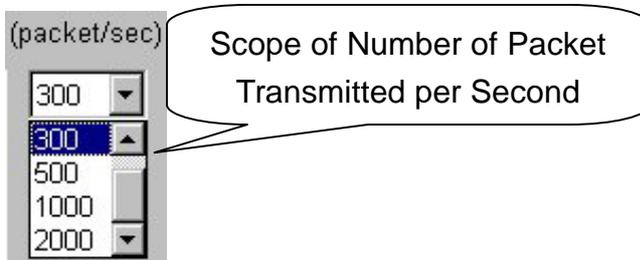

- ⑦ When selecting “SNMP MIB 1, || Variable” on [Traffic Selection] Box, basic information of Data Protocol Packet with wired and wireless transmission can be confirmed on Related Information Confirm Box.
- ⑧ When “SNMP MIB 1, || Variable” is selected, information such as IP, TCP/UDP, ICMP, 802.11(Card) MIB can be confirmed. Because ICMP has many MIB items, it can be confirmed by dividing ICMP1 and ICMP2.

- SNMP : Simple Network Management Protocol
- MIB : Management Information Base

Traffic Selection

SNMP MIB I,II Variables

Select **MIB** Type

IP	TCP/UDP	ICMP1	ICMP2	Card	
ipForwarding		1		ipOutDiscards	0
ipDefaultTTL		64		ipOutNoRoutes	2
ipInReceives		997		ipReasmTimeout	30
ipInHdrErrors		0		ipReasmReqds	0
ipInAddrErrors		9		ipReasmOKs	0
ipForwDatagrams		0		ipReasmFails	0
ipInUnknownProtos		2		ipFragOKs	0
ipInDiscards		0		ipFragFails	0
ipInDelivers		986		ipFragCreates	0
ipOutRequests		949		ipRoutingDiscards	0

Related Information Confirm Box

- ⑨ Confirming Traffic information you want enables more efficient AP operation.

## 15. AP Setting Using Web Browser

- ① Open Web Browser. (Beyond IE 4.0 or Netscape 4.0)
- ② Enter AP's IP Address on "Address" of the Web Browser.  
Press [ENTER : ↵] key.

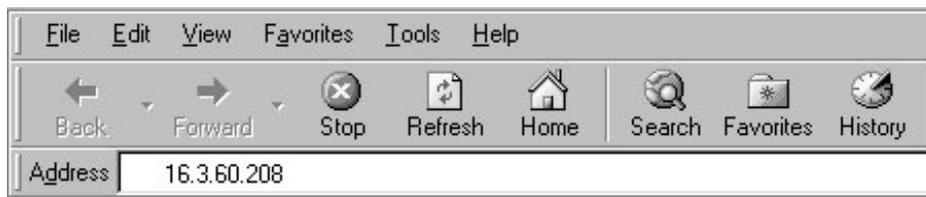

- ③ "Enter Network Password" window appears. Do not enter the User Name. Enter the password. (The default value is "public", and user can change the password later)



Click [OK] button.

**Notice :** *Capital•Small letter distinction is recommended for the password.*

- ④ Internet Connection Setting page”(default page) appears.

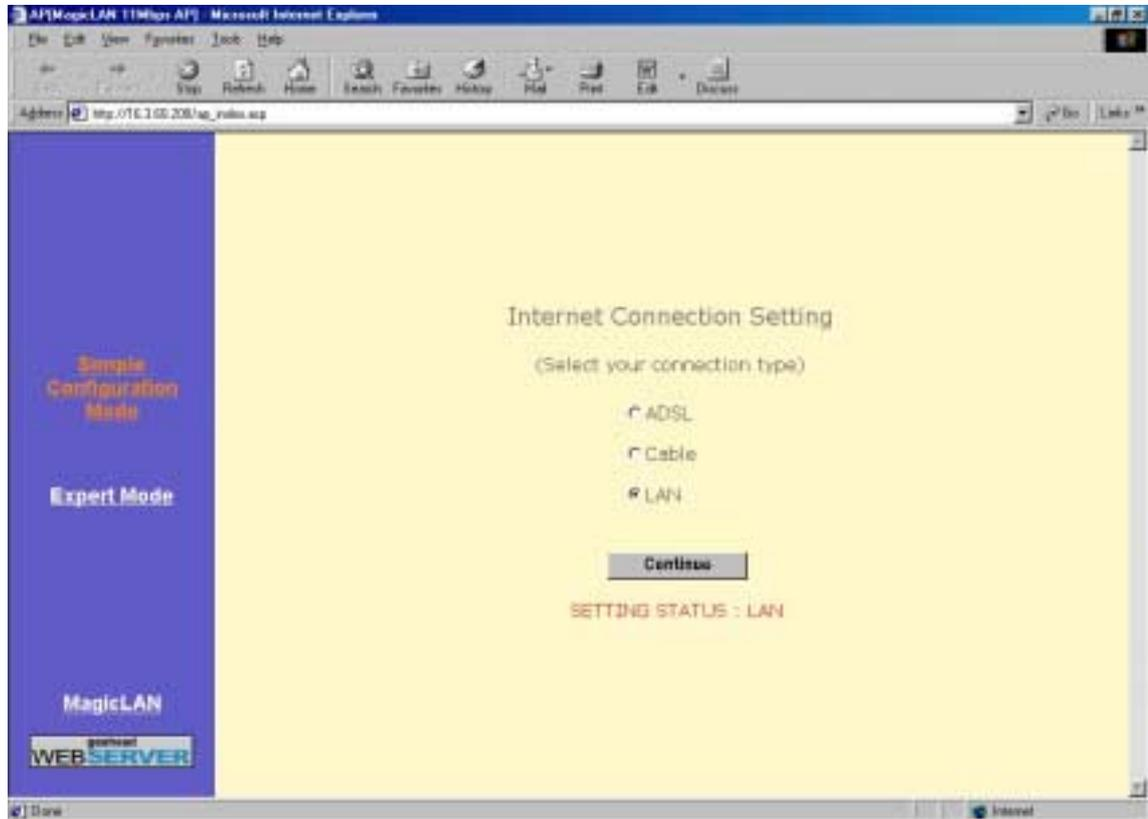

- ⑤ **Simple Configuration Mode** is for Setting of Internet Connection Environment, and refer to “**10. ADSL and Cable Modem Connection Setting Using AP Manager**”.
- ⑥ **Expert Mode** is for Network Administration, and refer to “**3. AP Basic Setting Using AP Manager**”.

## 16. AP Setting Using TELNET

- ① Open “Run” on [Start] menu of desktop and notebook PC. Enter the IP Address for Internet Connection as following Example.  
Example) telnet \*.\*.\*.\*.\*.\*.\* (IP Address )

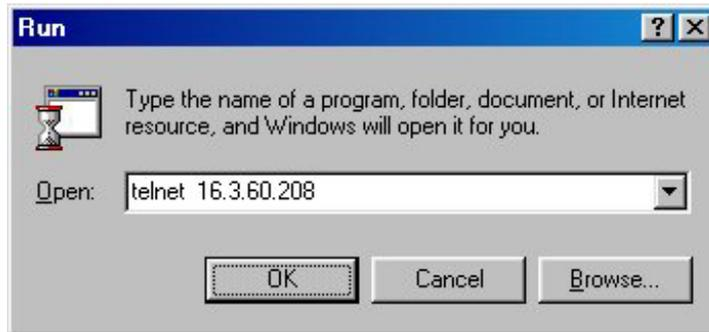

Click [OK] button.

- ② Telnet order window appears, and please refer to “18. AP Basic Setting Using RS-232C(COM Port)”

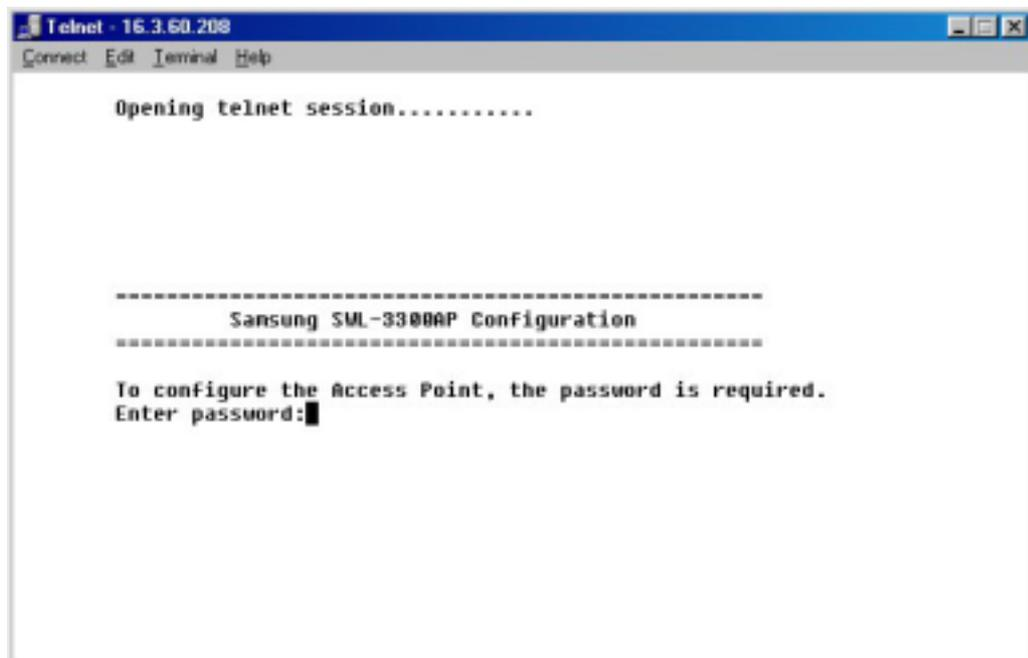

## 17. HyperTerminal Setting for RS-232C(COM Port) Communication

- ① Execute the **HyperTerminal** under MS-Windows 95/98/Me/2000/NT/XP operating system by following the steps below.  
Execute Hypertrm.exe file in “HyperTerminal” folder.

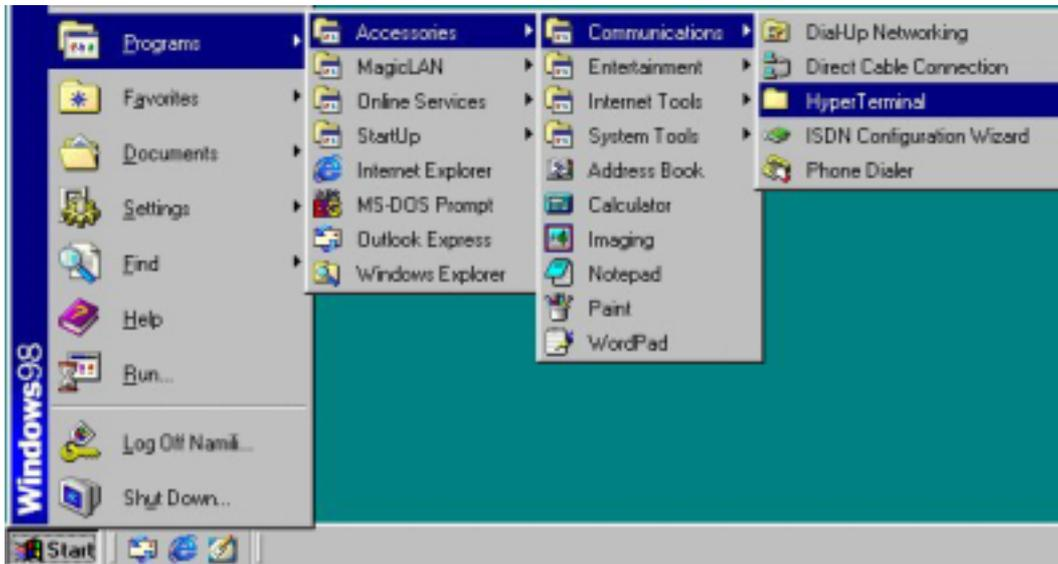

- ② After executing the Hypertrm.exe file, the following window will be displayed on MS-Windows.



- ③ As displayed above, type “**AP MANAGER**” in the name field, and click [OK] button. You can enter any name you wish for the connection.
- ④ Select the modem port as shown in the window below, and click [OK] button. (In most of the cases, select either “**Direct to Com1**” or “**Direct to Com2**”.)



- ⑤ You will view the following window and must set the properties of the selected COM port as shown below. Click [OK] button, and then press [ENTER : ↵].

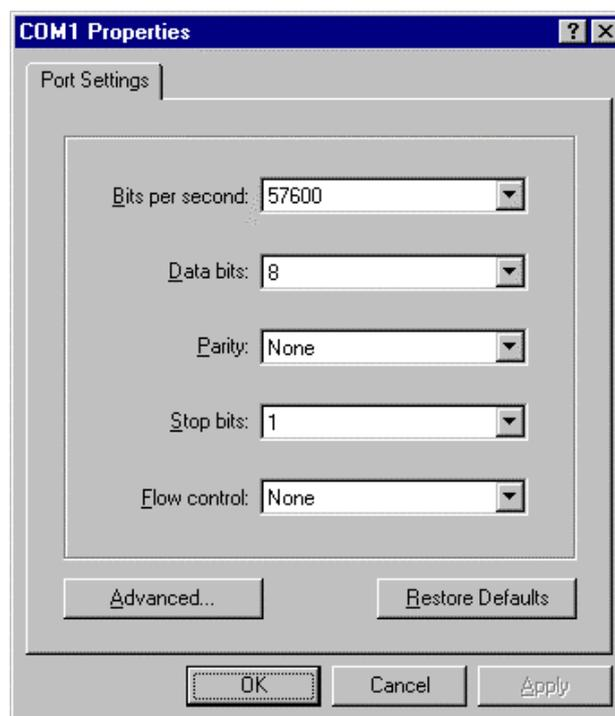

- ⑥ If all the steps above are executed correctly, then the following menu will be displayed on the HyperTerminal window. The default password is “public”, and user can change password later.

```
=====
                        Samsung SWL-3300AP Configuration
=====

To configure the Access Point, the password is required.
Enter password :
```

- ⑦ When the password is entered, the following [ROOT] menu appears on the HyperTerminal window.

```
=====
                        Samsung SWL-3300AP Configuration
=====

[ ROOT ]
  1. Basic           [Menu]
  2. Advanced       [Menu]
  3. Server         [Menu]
  4. Status         [Menu]
  5. Load default values
  6. Save and reboot

CMD(t, p, h):
```

t: Top Menu([ROOT])  
p: Previous Menu  
h: Help

- ⑧ When AP setting procedure is completed, close HyperTerminal window. If this is your first installation, on closing the HyperTerminal, you will get the message “**Do you want to save session AP Manager?**”. Then, click [yes] button to save HyperTerminal setting.

## 18. AP Basic Setting Using RS-232C(COM Port)

- ① Choose [Basic] menu on [ROOT] menu.

```
=====
                        Samsung SWL-3300AP Configuration
=====

[ Basic ]
  1. ESSID                MagicLAN
  2. Channel              3
  3. DHCP Client         Disabled
  4. IP Address          10.0.0.2
  5. Subnet Mask         255.255.255.0
  6. Gateway Address     10.0.0.1
  7. Description         MagicLAN 11Mbps AP

CMD(t,p,h):  Enter Menu Number
```

- ② Select the following order to set Wireless LAN ESSID.

```
CMD(t,p,h): 1  ↵

Enter new ESSID {Max. 32 ASCII}: test_AP  ↵ 
```

Enter the proper ESSID (strings up to 32 characters) on “**Enter new ESSID {Max. 32 ASCII}:**”, and press [ENTER : ↵]. **ESSID** must consist of alphabetic and numeric characters, excluding space and special characters. (Capital•Small letter distinction)

New setting appears on [Basic] menu. Type **u** and press [ENTER : ↵] if you would like to return to the top menu [ROOT]. Otherwise, you will remain in [Basic] menu.

- ③ Select the following order to change Wireless Channel.

```
CMD(t,p,h): 2  ↵  
Enter new Channel {1-14}: 11  ↵
```

Enter the proper channel number after the phrase “**Enter new Channel {1-14}:**”. Then, press [ENTER : ↵]. Channel index should be between 1 and 14(differs from country to country).

**Notice :** *If you are operating two or more Access Points in the adjoining cells, keep the appropriate channel distance to avoid the interference. We recommend you to keep the distance of at least 4 channels in the adjoining cells.*

- ④ Only if AP is used for DHCP Client, you set DHCP Client with “Enabled”. In this case, there is no need to set ⑤, ⑥, ⑦ below. The default setting is “Disabled”.

```
CMD(t,p,h): 3  ↵  
Enter new DHCP Client {enable, disable}: disable  ↵
```

- ⑤ Select the following order to set IP Address.

```
CMD(t,p,h): 4  ↵  
Enter new IP Address : 16.3.60.208  ↵
```

Enter the proper IP address after “**Enter new IP Address :**”. Then, press [ENTER : ↵]. Consult your system administrator for setting the proper value of IP Address.

- ⑥ Select the following order to set Subnet Mask.

```
CMD(t,p,h): 5 ↵  
Enter new Subnet Mask : 255.255.255.0 ↵
```

Enter Subnet Mask

Enter the proper subnet mask after the phrase “**Enter new Subnet Mask :**”.  
Then, press [ENTER : ↵].  
Consult your system administrator for setting the subnet mask.

- ⑦ Select the following order to set Gateway Address.

```
CMD(t,p,h): 6 ↵  
Enter new Gateway Address : 16.3.60.1 ↵
```

Enter Gateway Address

Enter the proper Gateway Address after “**Enter new Gateway Address :**” .  
Then, press [ENTER : ↵].  
Consult your system administrator for setting the gateway address.

- ⑧ Description shows explanation about current AP and does not have to be set.  
Select the following order to perform setting.

```
CMD(t,p,h): 7 ↵  
Enter new Description {Max. 128 ASCII}: test ap ↵
```

Enter Description

Enter the proper Description after “**Enter new Description {Max. 128 ASCII}:**”. Then, press [ENTER : ↵].

⑨ If you want to change Password, select the following order on [ROOT] menu.

```
=====
                Samsung SWL-3300AP Configuration
=====

[ ROOT ]
  1. Basic                [Menu]
  2. Advanced             [Menu]
  3. Server               [Menu]
  4. Status               [Menu]
  5. Load default values
  6. Save and reboot

CMD(t,p,h): 2 ↵
```



Select [Administration] menu on [Advanced] Menu.

```
=====
                Samsung SWL-3300AP Configuration
=====

[ Advanced ]
  1. Internet Connection  [Menu]
  2. Wireless             [Menu]
  3. Bridge               [Menu]
  4. Access control       [Menu]
  5. Administration       [Menu]
  6. Upgrade FW via serial

CMD(t,p,h): 5 ↵
```



Select “Change password” on [Administration] menu.

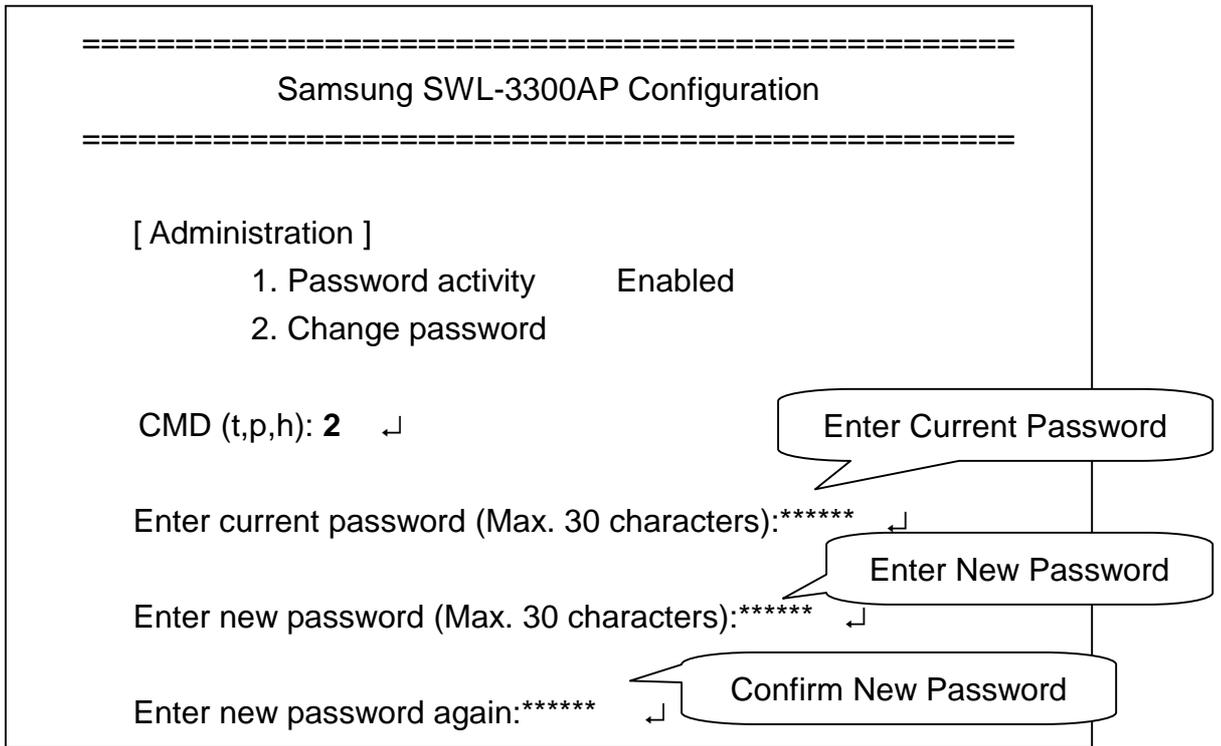

Enter the current password (Max. 30 characters) after “**Enter current password (Max. 30 characters):**”. Then, press [ENTER : ↵].

Enter the new password (Max. 30 characters) after “**Enter new password (Max. 30 characters):**”. Then, press [ENTER : ↵].

Enter the new password again after “**Enter new password again:**”. Then, press [ENTER : ↵].

**Notice :** *Please keep this password at a safe place or keep it where it may not get lost.*

- ⑩ You must select “**Save and reboot**” on [ROOT] menu, after changing the appropriate parameters by entering the new values.

```
=====
                Samsung SWL-3300AP Configuration
=====

[ ROOT ]

    1. Basic                [Menu]
    2. Advanced            [Menu]
    3. Server              [Menu]
    4. Status              [Menu]
    5. Load default values
    6. Save and reboot

CMD(t,p,h): 6  ↵  Select Save and reboot
```

By selecting the above menu, rebooting will occur automatically. The modified parameters of the **AP** will be changed effectively after it is rebooted. After the rebooting, you will view the following window to ask the password. If no further changes are needed in your settings, you do not need to enter the password.

```
=====
                Samsung SWL-3300AP Configuration
=====

To configure the Access Point, the password is required.
Enter password :
```

- ⑪ After following all the steps mentioned above, you can close the HyperTerminal window if there is no need for change or setting. Select [Basic] menu if you want to confirm the settings.

```
=====
                Samsung SWL-3300AP Configuration
=====

[ Basic ]

1. ESSID                test_AP
2. Channel              11
3. DHCP Client         Disabled
4. IP Address           16.3.60.208
5. Subnet Mask          255.255.255.0
6. Gateway Address     16.3.60.1
7. Description          test ap
```



## 19. Load default values Using RS-232C(COM Port)

- ⑫ Select “Load default values” on [ROOT] menu

```
=====
                        Samsung SWL-3300AP Configuration
=====

[ ROOT ]
  1. Basic                [Menu]
  2. Advanced            [Menu]
  3. Server              [Menu]
  4. Status              [Menu]
  5. Load default values
  6. Save and reboot

CMD(t, p, h): 5

All configured items will be set to the default values.
Do you really want (y/n)? y
```

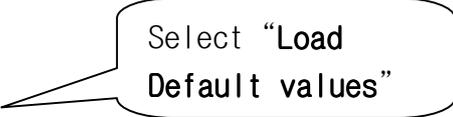

- ⑬ If you want to set default values, enter “y(yes)” after “Do you really want (y/n)?” then, press [Enter:↵]. AP configuration will return to default setting.
- ⑭ If all the steps above are executed correctly, a following sentence will be displayed.

All items was set to the default values.

## 20. Firmware Upgrade Using RS-232C(COM Port)

- ① Click the “Hyperterminal icon” saved in hard disk of your PC’



- ② “Enter password” menu will be displayed on the HyperTerminal window. The default password is “public”,
- ③ When the password is entered, [ROOT] menu appears on the HyperTerminal window.
- ④ Downloaded the latest version of AP firmware in local disk of your PC

**Notice:** AP firmware corresponding to your AP can be downloaded in MagicLAN home page.

- ⑤ After selecting [Advanced] menu on [ROOT] menu, select [Upgrade FW via serial] menu on [Advanced] menu again

```
=====
                        Samsung SWL-3300SA Configuration
=====

[ Advanced ]
    1. Radio                [Menu]
    2. Encryption           [Menu]
    3. HTTP Activity        Enabled
    4. Telnet Activity       Enabled
    5. Administration       [Menu]
    6. Upgrade FW via serial

CMD(t.b.h): 6 ↵
```

Select Upgrade FW via serial

AP Firmware can be upgraded via serial using 1k-xmode protocol.  
Power must be always on during the upgrade.

Do you really want to upgrade the firmware via serial ? (y/n):y ↵  
Do you really want (y/n)? y

- ⑥ If you want to upgrade the AP firmware, enter “y(yes)” after “**Do you really want to upgrade the firmware via serial ?**” then, press [Enter:↵]. Enter “y(yes)” again after “Do you really want (y/n)?”, then press [Enter:↵].  
The following window will be displayed.

```
#####  
AP will enter into the FIMWARE UPGRADE MODE  
#####  
  
>  
  
=====
```

Boot firmware  
(SST flash memory,0xBF)  
2000.12.09

```
=====
```

Type command([go]: normal operating or [help]: help)  
CMD : apfirm ↵

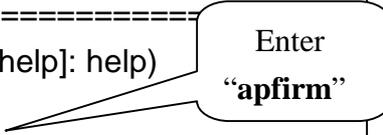

- ⑦ Enter the “apfirm” after “**CMD:** ” then, press [Enter ↵ ]

- ⑧ Select [transfer] menu on “Menu Bar” then, select “Send File“.

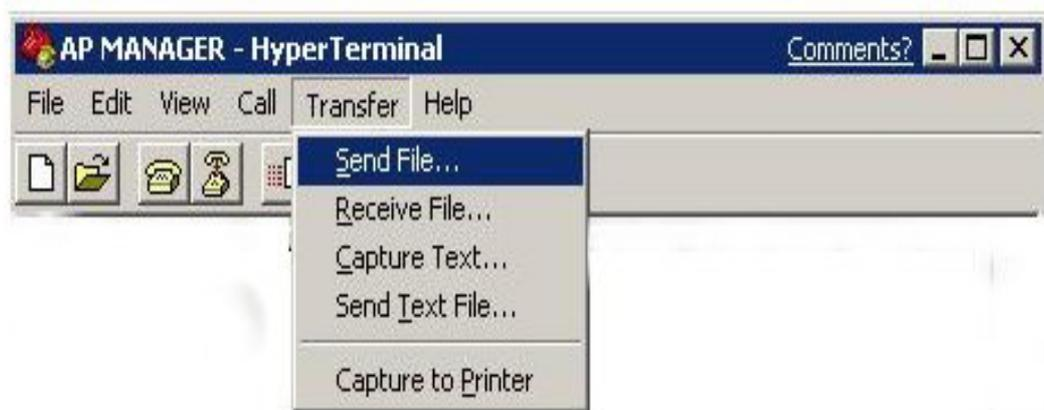

- ⑨ Click [Browse] button on the “Send File” window

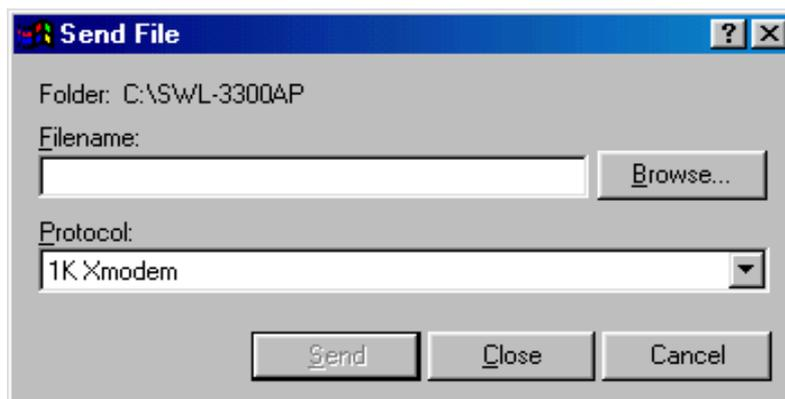

- ⑩ After select the firmware image file on opened window, click [Open] button.

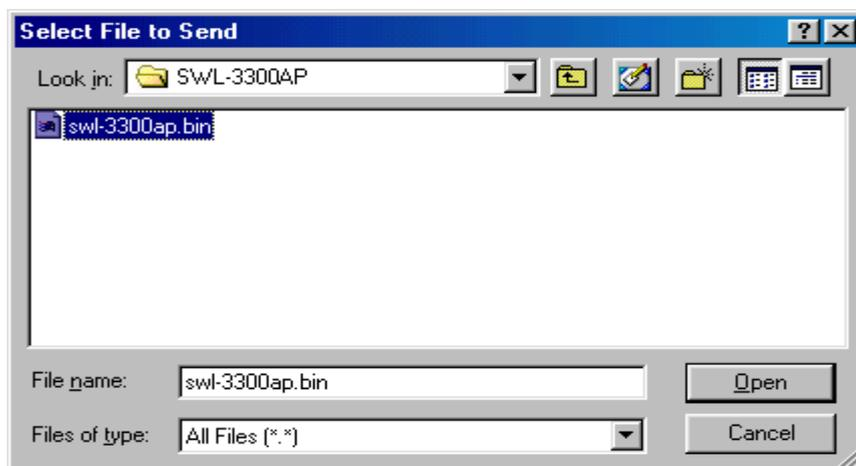

- ⑪ “1K Xmodem” should be selected on Protocol, then click [send] button.

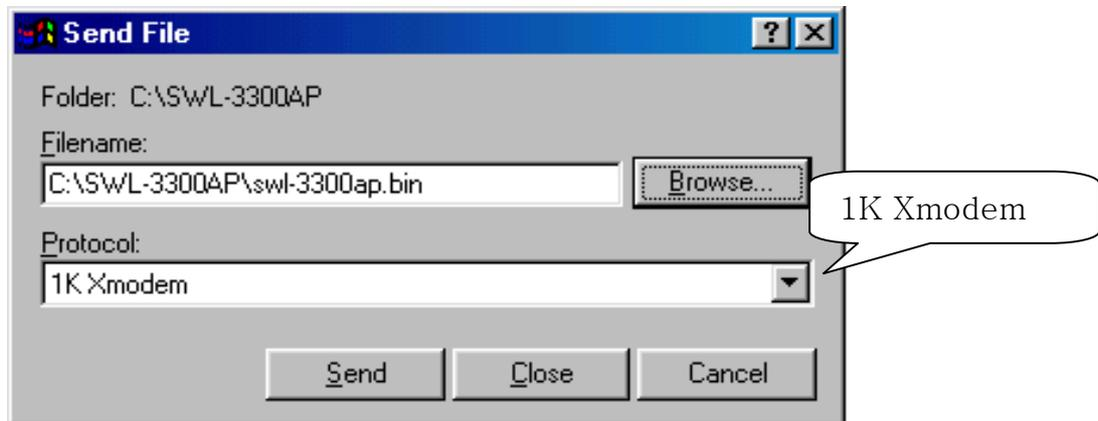

The following window shows the status of loading the AP firmware image file to the AP.

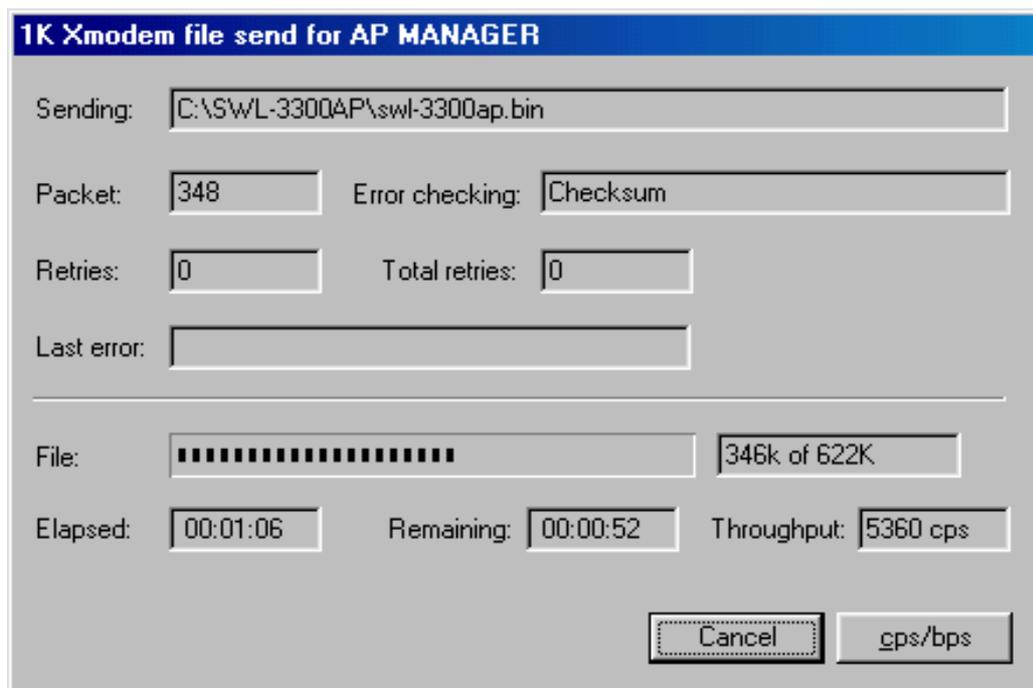

Notice: An error message will show up if AP firmware is not corresponding to your AP.

- ⑫ Firmware upgrade using RS-232C is recommended, only when “AP Manager” can not be used. (Refer to Chapter 13)

## APPENDIX | .

### Explanation of Basic Configuration to use AP Manager

#### ■ Explanation of AP External Icons



DC 5V Power LED(Green), it is always on.



IEEE 802.3 Wired LAN Connection LED(Orange), it is always on.



IEEE 802.11 Wireless LAN Connection LED(Green), it blinks.



Status LED(Red) - firmware upgrade / error occur

#### ■ Explanation of Detailed Names and Icons of AP Manager



This “AP Manager Execution Icon” appears on Desktop(under MS-Windows) of desktop and notebook PC.

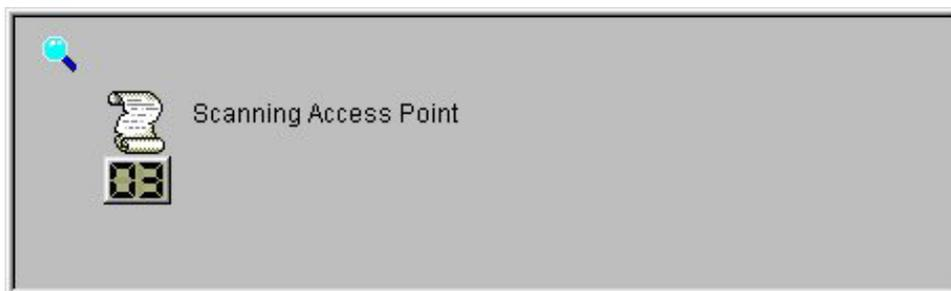

“AP Scan” window above appears during the first execution of AP Manager and also when [AP Scan] button is selected.

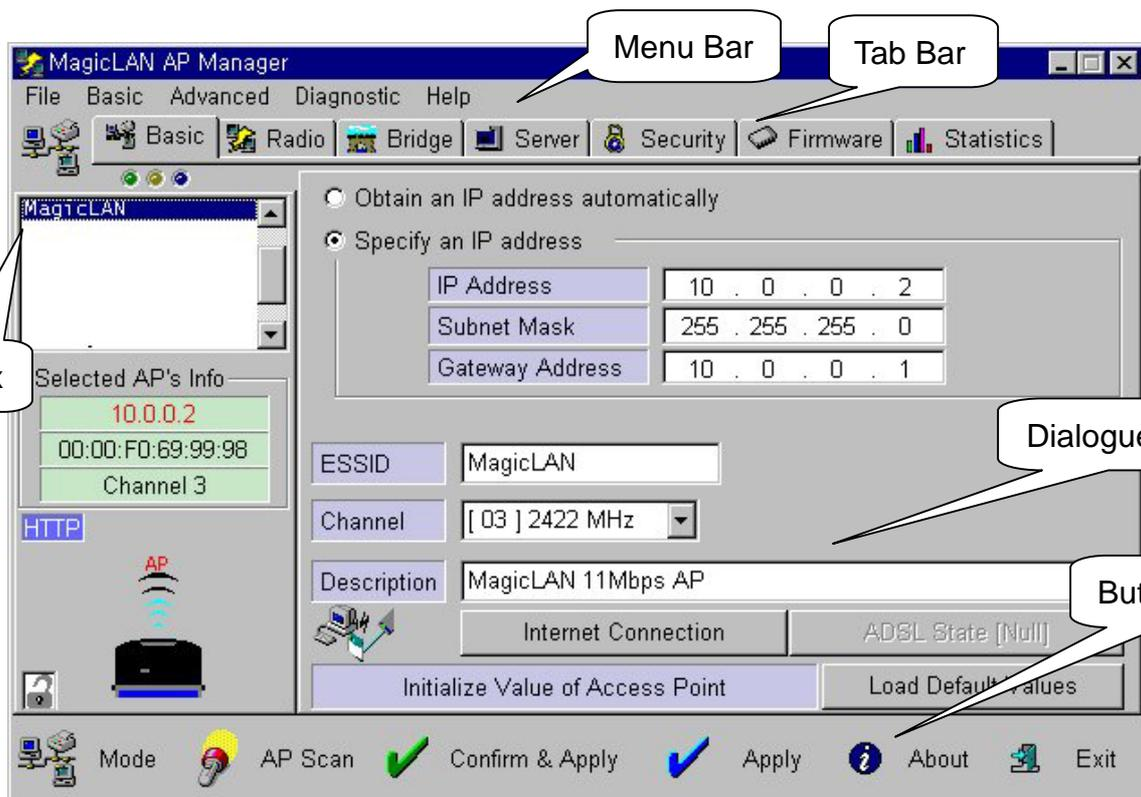

The window above shows “AP Manager” window.

File Basic Advanced Diagnostic Help

You can select menu from this “Menu Bar”.

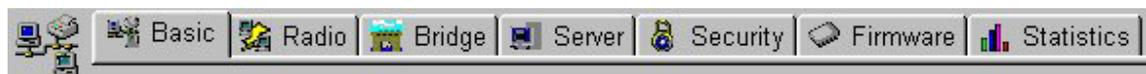

You can select each function of AP setting tabs on this “Tab Bar”. The very left icon shows currently selected tab.



This “LED icon” shows Sending and Receiving status of AP and Transmission status of ADSL. Sending, Receiving, and ADSL Transmission Status are shown on order.

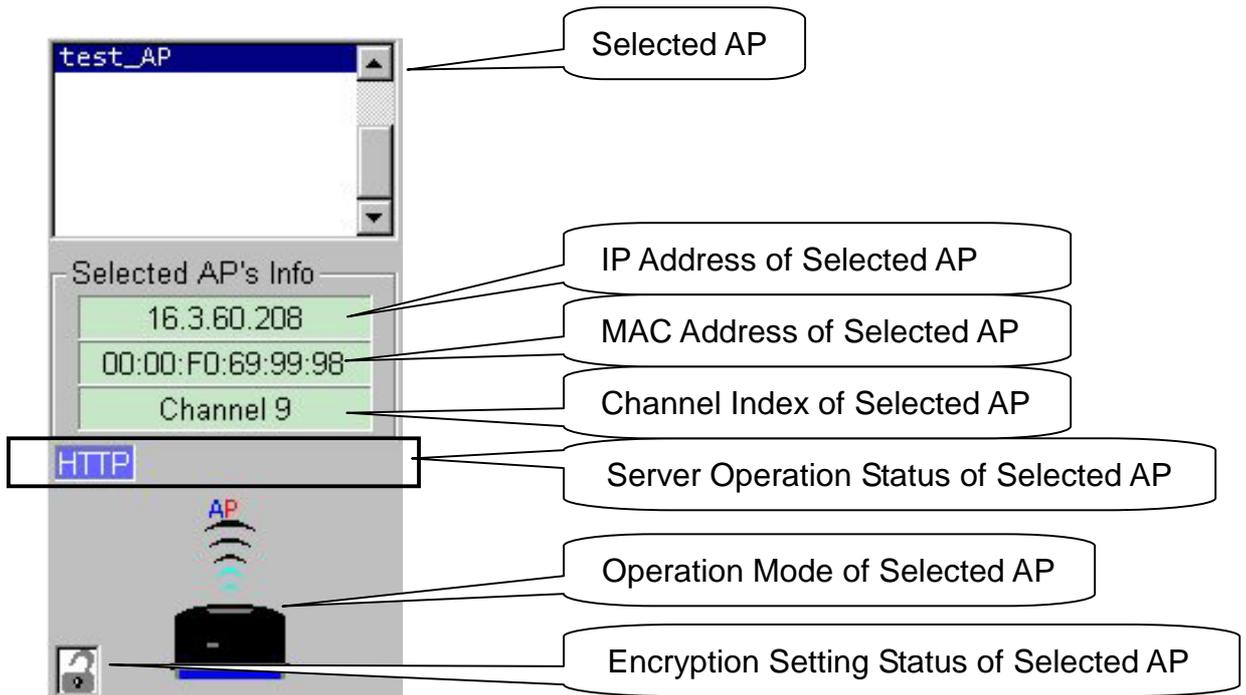

“List Box” shows Access Points connected to same network segment, and “Selected AP’s Info” shows simple information of selected AP.

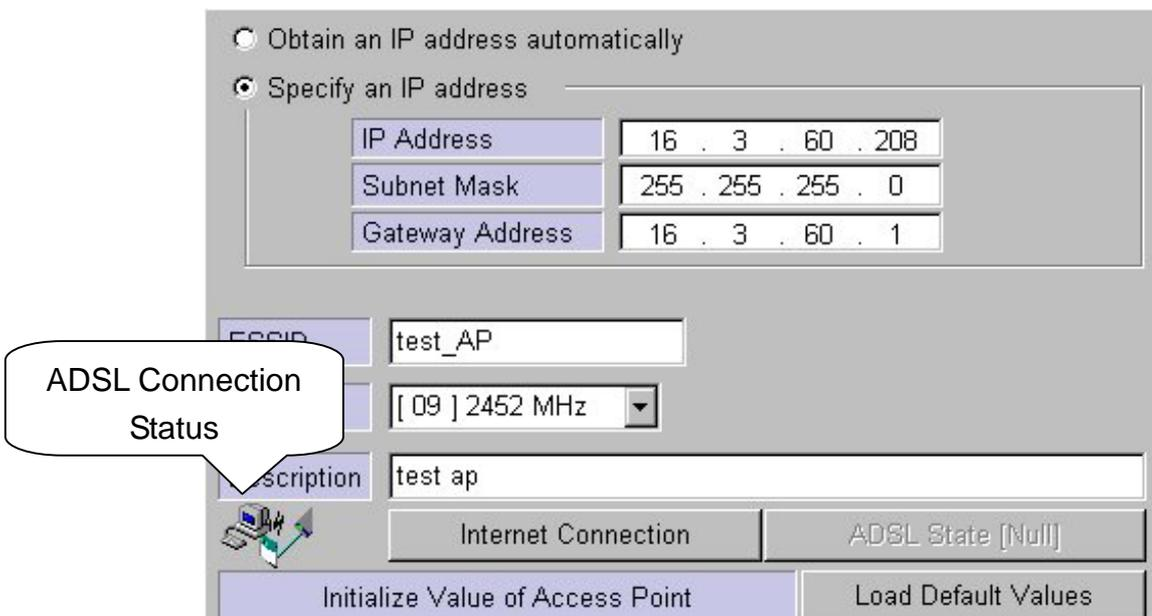

“Dialogue Box” is area for reading and writing setting values of AP. As shown above, each “Dialogue Box” with different information according to tab selected on “Tab Bar” appears. “Dialogue Box” about [Basic] tab also shows ADSL Connection Status.

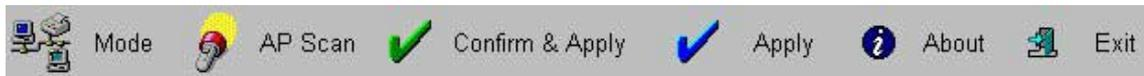

This “Button Bar” consists of buttons showing AP Scan, Entering setting values, AP information and AP Manager information.

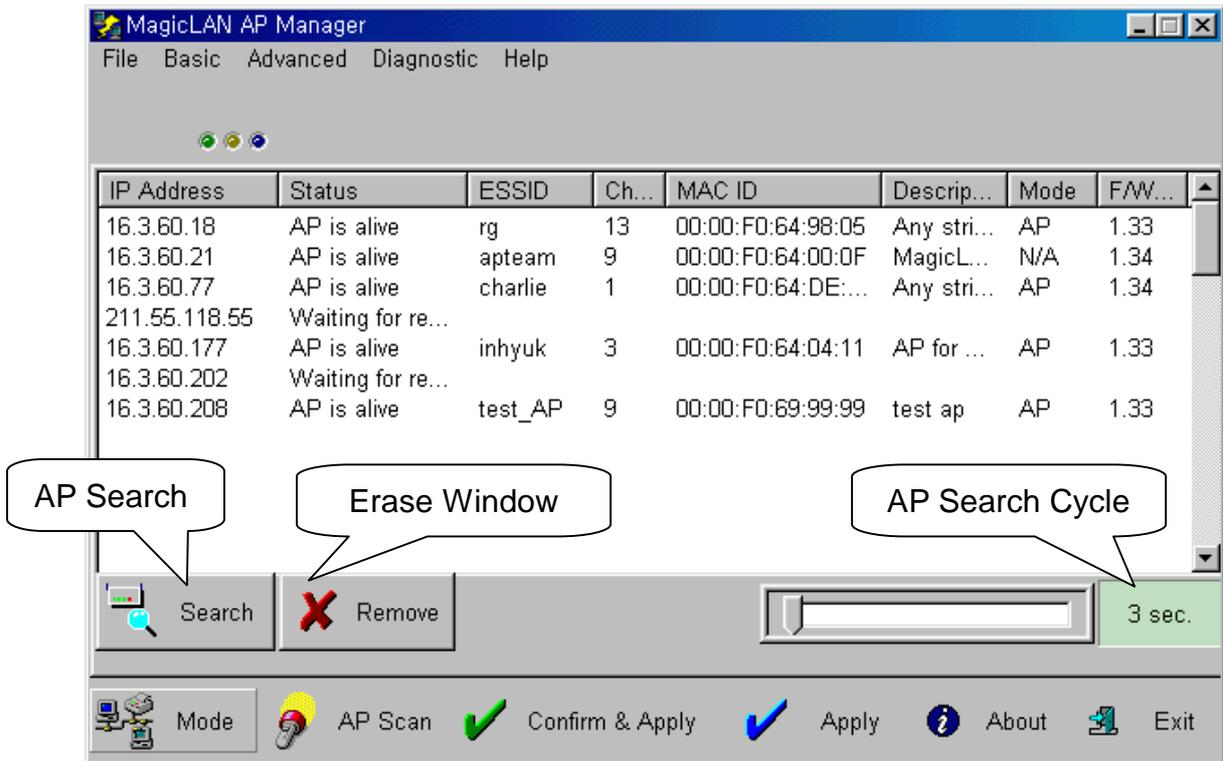

This is “AP Monitor Window” when you click [Mode] button from “Button Bar”. It shows APs connected around. Click [Mode] button to return to AP Manager mode.

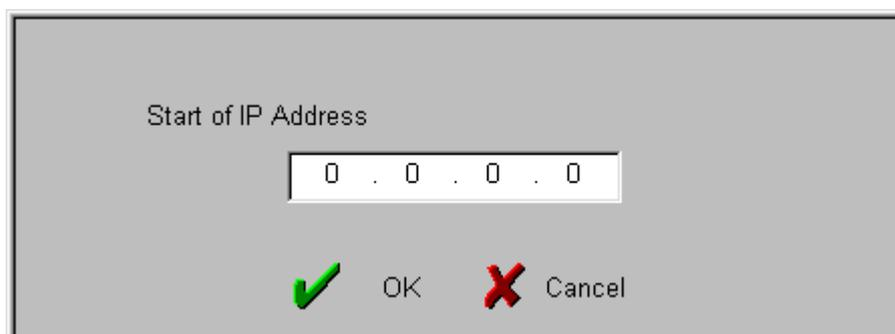

The window above is “Start IP Address Window” when you select [Search] button from “AP Monitor Window”.

### Configuration Summary

IP Address	16 . 3 . 60 . 208	ESSID	test_AP
Subnet Mask	16 . 3 . 60 . 1	Channel	9
Gateway	255 . 255 . 255 . 0	Frequency	2452 MHz

Web-based Management		Protocol Filter	Disabled
SNMP Agent		Operation Mode	AP
NAT Server		Encryption	Disabled
DHCP Server		Access Control	Enabled

 Apply
 Cancel

The window above shows “Configuration Summary”, and it appears when you select [Confirm & Apply] button.

Password

 OK
 Cancel

This is “Password Window” for user authentication. Click [Apply] button to open this window.

## APPENDIX II . Specification

<b>General</b>	
Wireless Network Architecture	IEEE 802.11b(DSSS)
Wired Network Architecture	Ethernet (10/100Mbps)
Power Adapter	90 ~ 265VAC 47/63 Hz to 5VDC 2A
Certifications	<b>EMC Emission :</b> - FCC Part 15 Class B - EN 55022 Class B <b>EMC Immunity :</b> EN 50082-1

<b>IEEE 802.11 Features</b>	
Data Rates	<ul style="list-style-type: none"><li>- 1Mbps, 2Mbps, 5.5Mbps, and 11Mbps</li><li>- Auto-fallback features</li><li>- Configuration of the Basic Data rates</li><li>- Configuration of Supported Data rates</li></ul>
Long/Short Preamble	Supports the long/short preamble
Power save	Complies with IEEE 802.11b PS(Powersave)
Beacon, DTIM Interval	Configuration of the Beacon and DTIM Interval
Roaming	IEEE 802.11b Compliant
Security	<ul style="list-style-type: none"><li>- 64(40)/128 Bit WEP Encryption</li><li>- Supports up to 4 WEP Keys for 64(40) Bit WEP</li></ul>

<b>Management Features</b>	
Local Configuration	Serial EIA-232
Remote Configuration	- HTTP, Telnet, SNMP supported - AP Manager for Microsoft Windows 95/98/2000/NT
Firmware Upgrade	Upgrading via Serial/Ethernet Interface supported
Automatic Searching AP	Easy to search the AP using AP Manager without knowing AP's IP Address
SNMP Compliance	MIB I, II and 802.11 MIB
IP Sharing	- Supports NAT (Network Address Translation) - All stations can share single IP address
IP Auto-configuration	Supports DHCP Server/Client features

<b>Other Supported Features</b>	
Wireless Bridging	Extends wireless networking using wireless bridging
Filtering	Ethernet Frame Type Filtering
Access Control	Ethernet Address Filtering
Max. Associations	Limits the maximum number of stations for load-balancing

<b>Radio Data</b>	
Radio	- 2.4 GHz ISM band (2.400-2.4835 GHz) - 11 Channels (US, Canada) - 13 Channels (ETSI, Korea) - 14 Channels (JAPAN)
Receiver Sensitivity	-84dBm at 11Mbps
Cell Coverage*	- Up to 150m(500ft) in Open Space - Up to 30m(100ft) in Office Environment
Output Power	Typical. 17dBm(70mW)

\* Cell Coverage may vary depending upon RF environment.

<b>Environmental Information</b>	
Operating Temperature	0°C to 45°C (32°F to 113°F)
Storage Temperature	-25°C to 70°C (-13°F to 158°F)
Humidity	95% Non-condensing

<b>Physical Characteristics</b>	
WLAN Interface	PCMCIA Release 2.1 (3.3V)
Wired Network Connection Type	10/100BaseT (RJ-45)
Serial Interface	EIA-232
Antenna Type	- Two Printed Antenna within wireless LAN card - Optional External Dipole Antenna
LED Indicator	Power, Ethernet Link, Wireless, and Status
Power Consumption	- SWL-3000AP, SWL-3000AP(DA) DC 5V, 1.1A - SWL-3300AP, SWL-3300AP(DA) DC 5V, 1.0A
Dimension	* Except the External Dipole Antenna - SWL-3000AP, SWL-3000AP(DA) 250 x 153 x 40 (mm) (9.84" x 6.02" x 1.57") - SWL-3300AP, SWL-3300AP(DA) 176 x 153 x 50 (mm) (6.92" x 6.02" x 1.96")
Weight	* Including the Power Adapter & Wireless LAN Card * Except the External Dipole Antenna - SWL-3000AP, SWL-3000AP(DA) 669g (1.47lb) - SWL-3300AP, SWL-3300AP(DA) 509g (1.12lb)

**Notice :** *The specifications can be changed without a prior notice.*

**We value your feedback.**

If you find errors or omissions in this manuscript, or if you can suggest ways to improve its usefulness, we would be pleased to hear from you.

Please contact us at :

E-mail:            wlanap@samsung.co.kr

You can find the latest firmware, software, and documents at:

**<http://www.magiclan.com/>**

## Free Manuals Download Website

<http://myh66.com>

<http://usermanuals.us>

<http://www.somanuals.com>

<http://www.4manuals.cc>

<http://www.manual-lib.com>

<http://www.404manual.com>

<http://www.luxmanual.com>

<http://aubethermostatmanual.com>

Golf course search by state

<http://golfingnear.com>

Email search by domain

<http://emailbydomain.com>

Auto manuals search

<http://auto.somanuals.com>

TV manuals search

<http://tv.somanuals.com>