

SAMSUNG

Operating Instructions and Cooking Guide

SPEED COOK OVEN



FQ159ST / FQ159UST

Owner's Manual

Download from www.Somanuals.com. All Manuals Search And Download.



Contents

Using This Manual	2
Important Safety Instructions.	2
Precautions to Avoid Possible Exposure to Excessive Microwave	2
Installation and Connection	6
Setting the Clock	7
Oven Features	8
Accessories	9
Control Panel.	10
Types of Heating	11
Using Oven Mode	12
Setting Oven Mode	12
Dual Convection Setting	14
Convection + Top Heat Setting	15
Conventional Heat Setting	16
Grill Setting.	17
Convection + Bottom Heat Setting.	18
Setting Cook Time	19
Setting End Time	20
Cooking Time Reservation Function	21
Using Speed Menu Mode	22
Setting Speed Menu Mode.	22
Guide to Auto Speed Menu Settings.	23
Using Speed Defrost Mode	25
Setting Speed Defrost Mode.	25
Guide to Auto Speed Defrost Settings.	26
How a Microwave Oven Works	27
Using Microwave Mode	28
Setting Microwave Mode.	28
Guide to Microwave Power Levels.	29
Microwave Cookware Guide	30
Microwave Cooking Guide	32
Switching Off the Beeper.	38
Child Safety Lock	39
Using the Steam Clean Feature	40
Cleaning Your Microwave Oven	41
Storing and Repairing Your Microwave Oven	41
Troubleshooting	42
Error Code	43
Technical Specifications	44

Using This Manual

Thank you for purchasing a SAMSUNG speed cook oven.

Your Owner's Manual contains important safety instructions and essential information on using and caring for your new speed cook oven.

Before using your oven, please read all the information in this manual and keep it for future reference.

A handy quick look-up guide explaining basic cooking operations is provided inside the front cover for your convenience.

Important Safety Instructions

PRECAUTIONS TO AVOID POSSIBLE EXPOSURE TO EXCESSIVE MICROWAVE ENERGY

Failure to observe the following safety precautions may result in harmful exposure to microwave energy.

- (a)** Under no circumstances should any attempt be made to operate the oven with the door open or to tamper with the safety interlocks (door latches) or to insert anything into the safety interlock holes.
- (b)** Do not place any object between the oven door and front face or allow food or cleaner residues to accumulate on sealing surfaces. Ensure that the door and door sealing surfaces are kept clean by wiping after use first with a damp cloth and then with a soft dry cloth.
- (c)** Do not operate the oven if it is damaged until it has been repaired by a qualified microwave service technician trained by the manufacturer. It is particularly important that the oven door closes properly and that there is no damage to the:
 - (1) Door (bent)
 - (2) Door hinges (broken or loose)
 - (3) door seals and sealing surfaces
- (d)** The oven should not be adjusted or repaired by anyone other than a properly qualified microwave service technician trained by the manufacturer.

WARNING

Accessible parts may become hot during use. Young children should be kept away.

- Do not use harsh abrasive cleaners or sharp metal scrapers to clean the oven door glass since they can scratch the surface, which may result in shattering of the glass. (if provided)
- When moving heating elements, make sure to use the equipment designed to move heating element while wearing safety gloves provided with the product, and see if temperature drops sufficiently (at least 10 minutes after grill or combination cooking operation) after operation.
- For safety reasons do not clean the appliance with a steam jet or high pressure cleaner.

Important Safety Instructions (Continued)

IMPORTANT SAFETY INSTRUCTIONS.

READ CAREFULLY AND KEEP FOR FUTURE REFERENCE.

Before cooking food or liquids in your microwave oven, please check that the following safety precautions are taken.

- Only use utensils that are suitable for use in microwave ovens;
DO NOT use any metallic containers, Dinnerware with gold or silver trimmings, Skewers, forks, etc.
Remove wire twist ties from paper or plastic bags.

Reason Electric arcing or sparking may occur and may damage the oven.

- When heating food in plastic or paper containers, keep an eye on the oven due to the possibility of ignition;
Do not use your microwave oven to dry newspapers or clothes
- If smoke is observed, switch off or unplug the appliance and keep the door closed in order to stifle any flames;
- Microwave heating of beverages can result in delayed eruptive boiling, therefore care must be taken when handling the container; To prevent this situation **ALWAYS** allow a standing time of at least 20 seconds after the oven has been switched off so that the temperature can equalize.
Stir during heating, if necessary, and **ALWAYS** stir after heating.

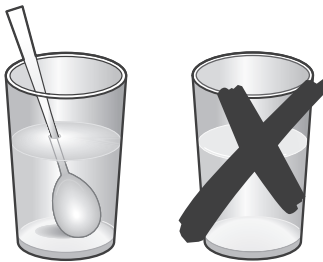

In the event of scalding, follow these FIRST AID instructions:

- * Immerse the scalded area in cold water for at least 10 minutes.
- * Cover with a clean, dry dressing.
- * Do not apply any creams, oils or lotions.
- **NEVER** fill the container to the top and choose a container that is wider at the top than at the bottom to prevent the liquid from boiling over. Bottles with narrow necks may also explode if overheated.
NEVER heat a babys bottle with the teat on, as the bottle may explode if overheated.
- The contents of feeding bottles and baby food jars shall be stirred or shaken and the temperature checked before consumption, in order to avoid burns;

Important Safety Instructions (Continued)

EN

- Eggs in their shell and whole hard-boiled eggs should not be heated in microwave ovens since they may explode, even after microwave heating has ended; Also do not heat airtight or vacuum-sealed bottles, jars, containers, nuts in shells, tomatoes etc.
- The oven should be cleaned regularly and any food deposits removed;
- Failure to maintain the oven in a clean condition could lead to deterioration of the surface that could adversely affect the life of the appliance and possibly result in a hazardous situation;
- **DO NOT** cover the ventilation slots with cloths or paper. They may catch fire as hot air is evacuated from the oven.
The oven may overheat and automatically switch itself off. It will remain inoperable until it has cooled sufficiently.
- **ALWAYS** use oven gloves when removing a dish from the oven to avoid unintentional burn.
- **DO NOT** touch heating elements or interior oven walls until the oven be cooled down.
- Do not immerse the power cable or plug in water and keep the power cable away from heated surfaces.
Do not operate this appliance if it has a damaged power cable or plug.
- Stand at arms length from the oven when opening the door.

Reason The hot air or steam released may cause scalding.

- You may notice a Clicking sound during operation(especially when the oven is defrosting).

Reason This sound is normal when the electrical power output is changing.

- **DO NOT** operate the microwave oven when it is empty. The power will be cut off automatically for safety. You can operate normally after letting it stand for over 30 minutes. It is best to leave a glass of water inside the oven at all times. The water will absorb the microwaves energy if the oven accidentally started.

Important Safety Instructions (Continued)

EN

IMPORTANT

- Young children should NEVER be allowed to use or play with the microwave oven. Nor should they be left unattended near the microwave oven when it is in use. Items of interest to children should not be stored or hidden just above the oven.
- This appliance is not intended for use by persons (including children) with reduced physical, sensory or mental capabilities, or lack of experience and knowledge, unless they have been given supervision or instruction concerning use of the appliance by a person responsible for their safety.
- Children should be supervised to ensure that they do not play with the appliance.
- During use the appliance becomes hot. Care should be taken to avoid touching heating elements inside the oven.
- **DO NOT** use harsh abrasive cleaners or sharp metal scrapers to clean the oven door glass since they can scratch the surface, which may result in shattering of the glass. (If provided)

WARNING:

If the door or door seals are damaged, the oven must not be operated until it has been repaired by a competent person.

WARNING:

It is hazardous for anyone other than a competent person to carry out any service or repair operation which involves the removal of a cover which gives protection against exposure to microwave energy.

WARNING:

Liquids and other foods must not be heated in sealed containers since they are liable to explode.

WARNING:

Only allow children to use the oven without supervision when adequate instructions have been given so that the child is able to use the oven in a safe way and understands the hazards of improper use.

WARNING:

When the appliance is operated in the combination mode, children should only use the oven under adult supervision due to the temperatures generated.

WARNING:

Accessible parts may become hot during use. Young children should be kept away.

- The microwave oven shall not be placed in a cabinet

Installation and Connection

EN

- This appliance is NOT intended for use in a commercial environment.
- Please observe the installation instructions provided and note that this appliance should only be installed by a qualified technician.
- The appliance is fitted with a plug and must only be connected to a properly installed earthed socket. The fuse protection must be rated at 16 amps (L or B-type miniature circuit breakers).
- In case a new socket is need, installation and cable connection must only be done by a qualified electrician. If the plug is no longer accessible following installation, a pole disconnecting device must be present on the installation site with a contact gap of at least 3 mm.
- Adapters, multiway strips and extension cords must not be used. Overloading can result in fire.
- **Plug in**

When the appliance has been connected for the first time, all segments are lit for a second. After 3 seconds, 12:00 flashes in the display prompting you to select the clock. Do not forget to reset the clock when you switch to and from summer or winter.

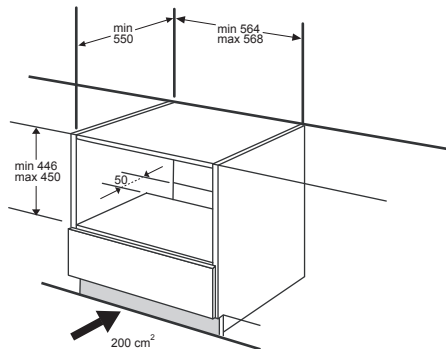
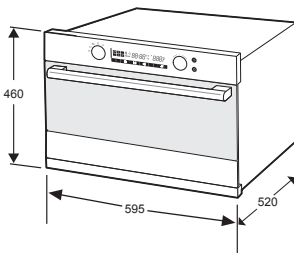

Setting the Clock

When the appliance is first plugged in, the **DISPLAY** lights up. After three seconds, the **Clock** symbol and “12:00” blink on the **DISPLAY**.

EN

Setting the Clock

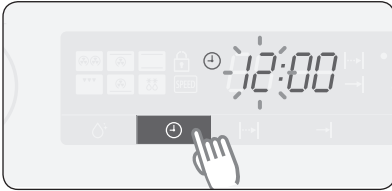

- 1** Press **CLOCK**. The “12” starts blinking.

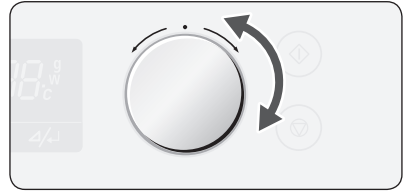

- 2** Turn **MULTI-FUNCTION SELECTOR** to set hour.

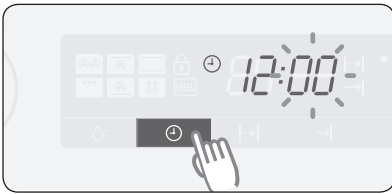

- 3** Press **CLOCK** again. The “00” starts blinking.

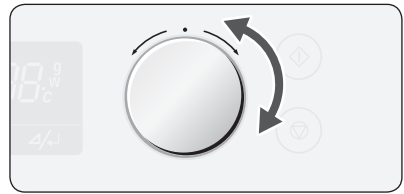

- 4** Turn **MULTI-FUNCTION SELECTOR** to set minute.



- 5** Press **CLOCK** again. The clock sets by itself within 5 seconds.

Oven Features

EN

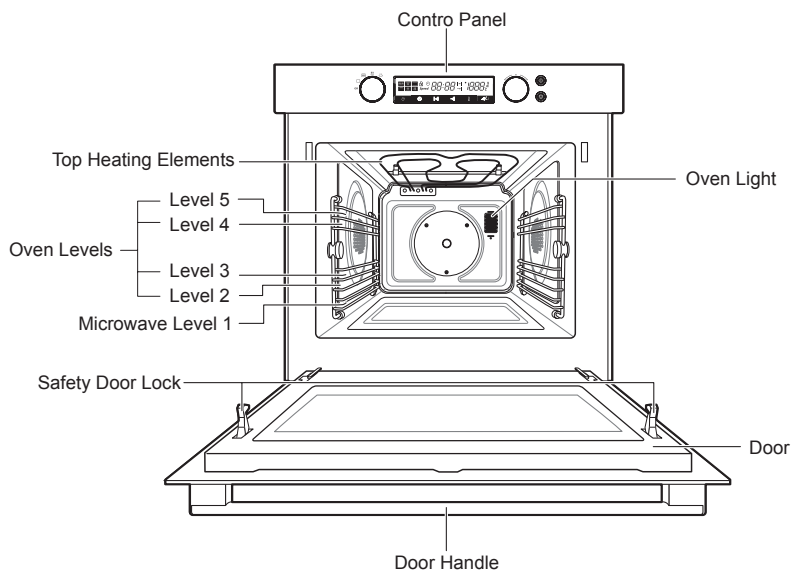

Note

- Shelf levels are numbered from the bottom up.
- The levels 4 and 5 are mainly used for grill function.
- The microwave level is mainly used for microwave function.
- Please refer to Cooking Guides provided throughout this booklet to determine appropriate shelf level for your dishes.

Accessories

The following accessories are provided with your microwave oven:

EN

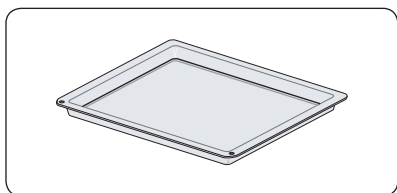

- 1** Ceramic Tray
(Useful for Microwave Mode)

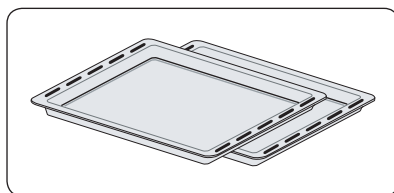

- 2** Two Baking Trays
(DO NOT use for Microwave Mode.)

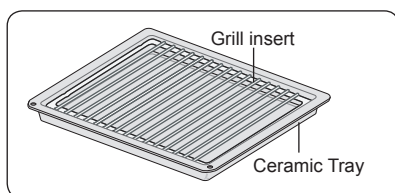

- 3** Grill Insert for Ceramic Tray
(Useful for Speed Menu and Grill Mode)

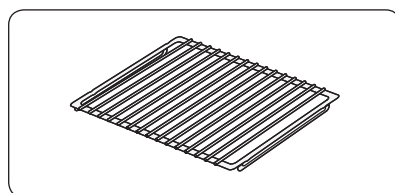

- 4** Oven Rack
(DO NOT use for Microwave Mode.)

Note

Please refer to Cooking Guides provided throughout this booklet to determine appropriate accessory for your dishes.

Control Panel

EN

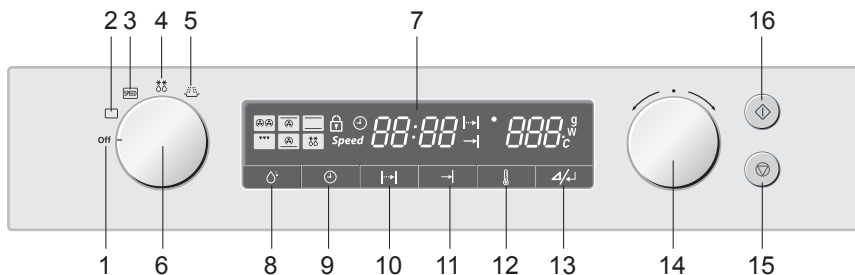

- | | |
|-----------------------|-----------------------------|
| 1. OFF | 9. CLOCK |
| 2. OVEN MODE | 10. COOK TIME |
| 3. SPEED MENU MODE | 11. END TIME |
| 4. SPEED DEFROST MODE | 12. TEMPERATURE |
| 5. MICROWAVE MODE | 13. POWER LEVEL/ENTER |
| 6. MODE SELECTOR | 14. MULTI-FUNCTION SELECTOR |
| 7. DISPLAY | 15. STOP / CANCEL |
| 8. STEAM CLEAN | 16. START |

Using Pop Up Dials

Note

The **MODE SELECTOR** (6) and **MULTI-FUNCTION SELECTOR** (14) are pop up dials. Simply press and turn to desired setting.

Types of Heating

EN

The following chart summarizes the various heating modes and settings available on your oven. Use the Cooking Guides in the pages that follow to determine the appropriate mode and setting for all your recipes.

OVEN MODE



Dual Convection Setting

Food is heated by hot air from the left and right sides of the oven. This setting provides uniform heating and is ideal for baking.



Convection + Top Heat Setting

Hot air and top heating element combine, making this setting ideal for crisping and browning. Especially recommended for meats.



Conventional Heat Setting

Heat comes from top and bottom heating elements. This setting is suitable for baking and roasting.



Grill Setting

Food is heated by the top heating element.



Convection + Bottom Heat Setting

Hot air and the bottom heating element combine so food can be crisped and browned.

SPEED MENU MODE



Choose from twelve pre-programmed speed menu settings to conveniently cook, roast or bake your favourite foods. Cooking time and power level are automatically set. Simply select the programme and weight to start cooking.

SPEED DEFROST MODE



Choose from five pre-programmed speed defrost settings for defrosting. Defrosting time and power level are automatically set. Simply select the programme and weight to start defrosting.

MICROWAVE MODE



Microwave energy is used to cook and defrost foods. It provides fast efficient cooking without changing the colour or form of food. Power level and cooking time are manually set to suit various dishes.

Using Oven Mode

EN

Five settings are available under this mode. Check *Cooking Guides* on pages 14 - 18 to determine appropriate setting.



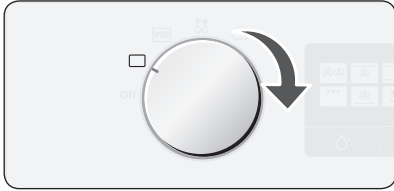



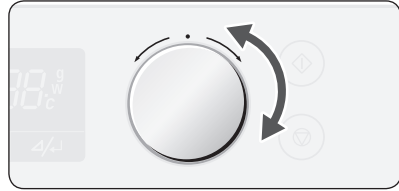



Setting Oven Mode



1 Turn **MODE SELECTOR** Dial to oven mode position.



2 Turn **MULTI-FUNCTION SELECTOR** Dial to desired oven mode. The oven mode and recommended temperature will be displayed.

	Dual Convection	
	Convection + Top Heat	
	Conventional Heat	
	Grill	
	Convection + Bottom Heat	

Note

The convection heater and grill heater switch on and off constantly to regulate the temperature.



3 To change temperature, press **TEMPERATURE** and turn **MULTI-FUNCTION SELECTOR** to set desired temperature.

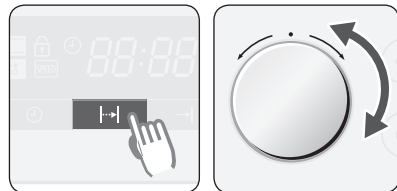

4 To set cooking time, press **COOK TIME** and turn **MULTI-FUNCTION SELECTOR** to set desired cooking time.

Using Oven Mode (Continued)

EN



- 5** Press **START**.
▶ The **TEMPERATURE** indicator on display will be lit and the indicator will blink after the temperature is reached.

Note

- 1) During cooking, **COOK TIME** and **TEMPERATURE** are available to change the setting.
- 2) In Oven Mode settings, the convection heater and top and bottom heating elements switch off and on throughout cooking to regulate the temperature.
- 3) During cooking, the inside temperature is displayed by pressing **TEMPERATURE** and **POWER LEVEL / ENTER** at the same time.

Important

When using Oven Mode, be sure glass baking dishes are suitable for 40 - 250 °C cooking temperatures.

Using Oven Mode (Continued)

EN

Dual Convection () Setting

Food is heated by hot air from the left and right sides of the oven. This setting provides uniform heating and is ideal for baking.

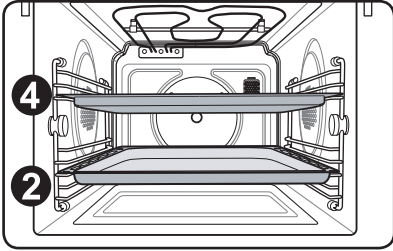

When you cook on two baking trays at the same time, place the trays on level **2**, and level **4**.

* Please ensure that glass baking dishes are suitable for 40 ~ 250 °C cooking temperatures.

Cooking Guide

Use temperatures and times in this table as guidelines for baking.

We recommend to preheat the oven with dual convection mode.

Food Item	Shelf Level	Temperature (°C)	Accessory	Time (h)
Hazelnut Cake Square Mould	2	160 - 170	Oven rack	1:00 - 1:10
Lemon Cake Ring-shaped or Bowl Mould	2	150 - 160	Oven rack	0:50 - 1:00
Sponge Cake	3	150 - 160	Oven rack	0:35 - 0:45
Fruit Flan Base	3	150 - 170	Oven rack	0:25 - 0:35
Flat Streusel Fruit Cake (Yeast dough)	3	150 - 170	Baking tray	0:30 - 0:40
Croissants	3	170 - 180	Baking tray	0:10 - 0:15
Bread Rolls	2	180 - 190	Baking tray	0:10 - 0:15
Cookies	3 / 4	160 - 180	Two baking trays	0:10 - 0:20

Note

Preheating is recommended.

Using Oven Mode (Continued)

EN

Convection + Top Heat () Setting

Hot air and top heating element combine, making this setting ideal for crisping and browning. This setting is especially recommended for cooking meats.

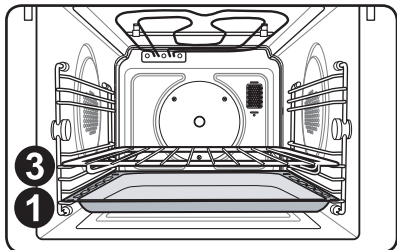

When cooking meat, place on rack on Level **3** and set baking tray on Level **1** to catch drippings.

* Please ensure that glass baking dishes are suitable for 40 ~ 250 °C cooking temperatures.

Cooking Guide

Use temperatures and times in this table as guidelines for roasting.

We recommend to preheat the oven using Convection+Top Heat mode.

Put meat on oven rack, follow shelf level advice in the table and use baking tray as oil pan on level 1.

Food Item	Shelf Level	Temperature (°C)	Accessory	Time (h)
Beef Roast Beef / 1kg Medium	3 / 1	170 - 190	Oven rack / Baking tray	1:00 - 1:30
Pork Shoulder Joint / Roll 1 kg	3 / 1	180 - 200	Oven rack / Baking tray	1:30 - 2:00
Lamb Roast Lamb / Leg of Lamb 0.8 kg	2 / 1	190 - 210	Oven rack / Baking tray	0:50 - 1:20
Chicken Whole Chicken 1.0 kg	3 / 1	170 - 190	Oven rack / Baking tray	0:50 - 1:10
Fish Whole Trouts 2 pcs / 0.5 kg	4 / 1	170 - 180	Oven rack / Baking tray	0:30 - 0:40
Duck Breast 0.3 kg	4 / 1	180 - 200	Oven rack / Baking tray	0:25 - 0:35

Note

Preheating is recommended.

Using Oven Mode (Continued)

EN

Conventional Heat () Setting

Heat comes from top and bottom heating elements. This setting is suitable for baking and roasting.

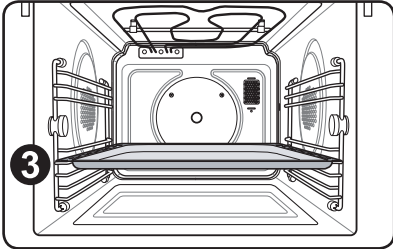

Baking tray or oven rack is usually placed on Level

3.

* Please ensure that glass baking dishes are suitable for 40 ~ 250 °C cooking temperatures.

Cooking Guide

Use temperatures and times in this table as guidelines for baking. We recommend to preheat the oven with Conventional Heat mode.

Food Item	Shelf Level	Temperature (°C)	Accessory	Time (h)
Lasagne	3	200 - 220	Oven rack	0:25 - 0:35
Vegetables Gratin	3	180 - 200	Oven rack	0:20 - 0:30
Potato Gratin	3	180 - 200	Oven rack	0:25 - 0:35
Frozen Pizza Baguettes	3	160 - 180	Baking tray	0:10 - 0:15
Oven Chips	3	200 - 220	Baking tray	0:15 - 0:20
Marble Cake	3	180 - 200	Oven rack	0:50 - 1:10
Muffins	3	180 - 200	Oven rack	0:10 - 0:15
Cookies	4	180 - 200	Baking tray	0:08 - 0:15

Note

Preheating is recommended.

Using Oven Mode (Continued)

Grill () Setting

Food is heated by the top heating elements.

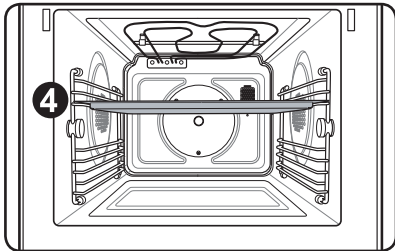

For grilling, ceramic tray with grill insert is usually placed on Level **4**.

* Please ensure that glass baking dishes are suitable for 40 ~ 250 °C cooking temperatures.

Cooking Guide

Use temperatures and times in this table as guidelines for grilling.

Set 220 °C grill temperature, preheat for 3 minutes.

Food Item	Shelf Level	Time (min) 1 st side	Time (min) 2 nd side	Accessory
Kebab Spits	4	8 - 10	6 - 8	Grill insert with ceramic tray
Pork Steaks	4	7 - 9	5 - 7	Grill insert with ceramic tray
Sausages	4	4 - 6	3 - 5	Baking tray
Chicken Pieces	4	10 - 15	8 - 10	Grill insert with ceramic tray
Salmon Steaks	4	8 - 12	6 - 10	Grill insert with ceramic tray
Sliced Vegetables	5	5 - 7	3 - 5	Baking tray
Toast	5	2 - 3	1 - 2	Oven rack
Cheese Toasts	5	4 - 5	-	Oven rack

Note

Recommended temperature for grilling is 220 °C.
Preheating for three minutes is recommended.

Using Oven Mode (Continued)

EN

Convection + Bottom Heat () Setting

Hot air and the bottom heating element combine to heat food. This is a useful setting for crisping and browning.

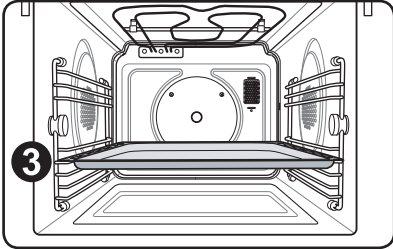

Baking tray or oven rack is often used on Level **3**.

* Please ensure that glass baking dishes are suitable for 40 ~ 250 °C cooking temperatures.

Cooking Guide

Use temperatures and times in this table as guidelines for baking.

We recommend to preheat the oven with Convection + Bottom Heat mode.

Food Item	Shelf Level	Temperature (°C)	Accessory	Time (min)
Fresh Pizza	3	180 - 200	Baking tray	15 - 25
Chilled Pre-baked Quiche / Pie	2	180 - 200	Oven rack	10 - 15
Frozen Self Raising Pizza	2	180 - 200	Baking tray	15 - 20
Frozen Pizza	3	200 - 220	Oven Rack	10- 15
Chilled Pizza	3	180 - 220	Baking tray	08- 15
Frozen Puff Pastry with Fruit Filled	2	180 - 200	Baking tray	10- 15

Note

Preheating is recommended.

Setting Cook Time

EN

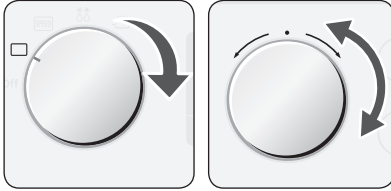

- 1** Select the desired oven function and temperature. (See also section "Changing the oven function and temperature")

Note : If there is no further entry on the control panel for 5 seconds, start key will blink.



- 2** Press **COOK TIME**.

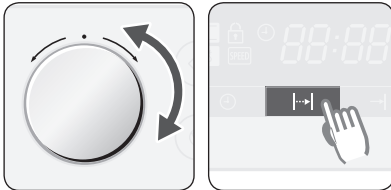

- 3** Turn **MULTI-FUNCTION SELECTOR** to set desired cook time.

- 1)** After 5 seconds, setting cook time ends automatically and **START** blinks.
- 2)** Press **COOK TIME** to end setting cook time.

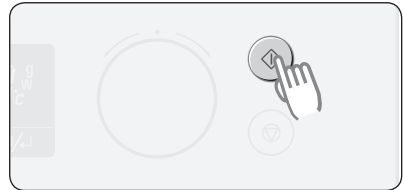

- 4** Press **START** the oven will start promptly.

- 5** When the set time has elapsed, an audible signal sounds and the oven switches itself off.

Note : More / Less function. During cooking, you can adjust the pre-set cooking time with **MULTI-FUNCTION SELECTOR** for better cooking performance.

Setting End Time

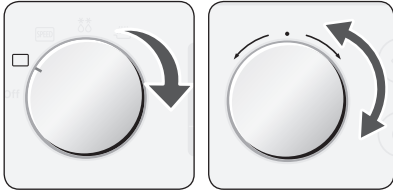

- 1** Select the desired oven function and temperature.



- 2** Press **END TIME**.
The current time will be shown blinking on the DISPLAY.

Example Current time is 13:00 The current time's digit "13:00" will blink.

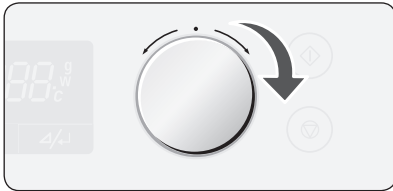

- 3** Turn **MULTI-FUNCTION SELECTOR** to set desired hour and minute. (14:00).

Example Desired time is 14:00.



- 4** Press **END TIME** again.

Example Current time is 13:00.
Desired end time is 14:00.
Cooking time "1:00" is displayed.

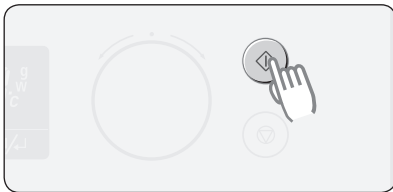

- 5** Press **START** to start the oven.
The oven will start promptly.

Note :

- 1) The cooking time will count down in the time display. When the set time has elapsed, an audible signal sounds and the oven switches itself off.
- 2) During cooking, you can adjust the preset cooking time with the **MULTI-FUNCTION SELECTOR** for better cooking performance.
- 3) During cooking, the inside temperature is displayed by pressing **TEMPERATURE** and **POWER LEVEL / ENTER** at the same time.

Cooking Time Reservation Function

Example : Current time : 12:00
Cook time :2:00 if you wish to end cooking at 18:00

EN

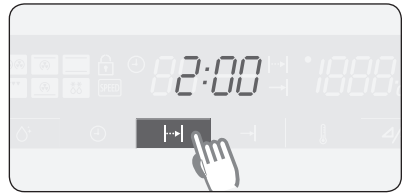
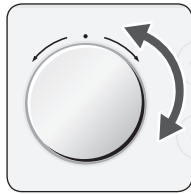
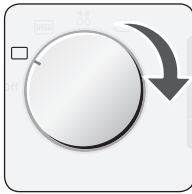

1 Select Oven Mode and desired function.

2 Select Cook Time and enter the desired cook time. (2:00)

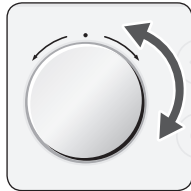

3 Press **END TIME**.
▶ "14:00", which cook time is added to current time, is displayed.
▶ Enter the desired End Time. (18:00)

4 Press **END TIME**.
▶ The oven automatically starts at the reserved time of 16:00.
▶ The Cook Time is displayed at the start of cooking.

Note :

- End Time is displayed when reservation is completed.
- Cook Time and End Time can be changed before the reserved time.

Using Speed Menu Mode

Speed Menu Mode allows you to choose from twelve pre-programmed settings to conveniently cook, roast or bake your favourite foods. Cooking time and power level are automatically set. Simply select one of the twelve settings and set the weight to start cooking.

Setting Speed Menu Mode

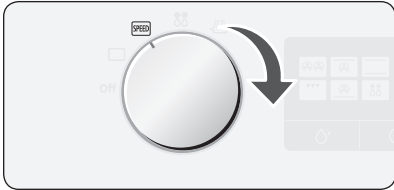

1 Turn **MODE SELECTOR** to Speed Menu position.

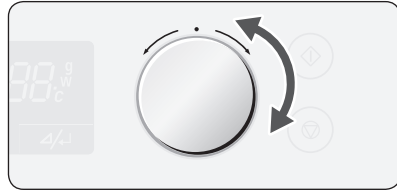

2 Turn **MULTI-FUNCTION SELECTOR** to select desired Speed Menu setting. Refer to table on pages 23 - 24 for a description of the 12 Speed Menu settings.

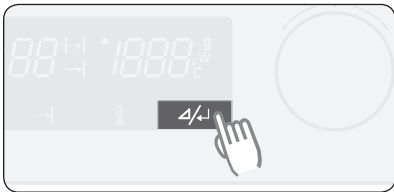

3 Press **POWER LEVEL / ENTER** to change weight.

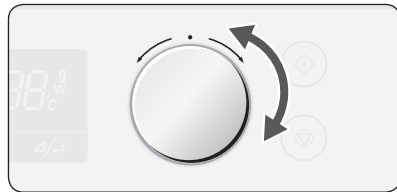

4 Turn **MULTI-FUNCTION SELECTOR** to select desired weight.

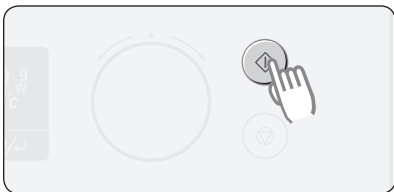

5 Press **START**.

Note

- Some of the speed menus are continuous. Others require the food to be turned over. the oven will beep to prompt you.
- The oven temperature set during the operation of the speed menu is displayed.
- Temperatures and times cannot be changed during cooking.

Using Speed Menu Mode (continued)

EN

Guide to Auto Speed Menu Settings

The following table presents 12 Auto Programmes for Speed Cooking, Roasting and Baking. It contains its quantities, standing times and appropriate recommendations. These auto programmes contain special cook modes, which have been developed for your convenience.

No	Food Item	Weight (kg)	Accessory	Shelf Level	Recommendation
1	Frozen Pizza	0.1 - 0.2 0.2 - 0.3 0.3 - 0.4 0.4 - 0.5	Grill insert with ceramic tray	4	Put frozen pizza in the middle of grill insert with ceramic tray.
2	Frozen Oven Chips	0.2 - 0.4 0.4 - 0.6 0.6 - 0.8	Baking tray	3	Distribute frozen Oven Chips on metal baking tray.
3	Frozen Croquettes	0.4 - 0.5 0.5 - 0.6 0.6 - 0.7 0.7 - 0.8	Grill insert with ceramic tray	4	Put frozen potato croquettes evenly on grill insert with ceramic tray.
4	Frozen Lasagne	0.3 - 0.4 0.5 - 0.6 0.7 - 0.8 0.9 - 1.0	Ceramic tray	3	Put frozen lasagne in a suitable glass pyrex or ceramic dish. After reheating let stand for 3 - 4 minutes.
5	Frozen Fish Gratin	0.3 - 0.4 0.5 - 0.6 0.7 - 0.8	Ceramic tray	3	Put frozen fish gratin in a suitable glass pyrex or ceramic dish. After cooking stand for 3 - 4 minutes.
6	Chicken Pieces	0.2 - 0.4 0.4 - 0.6 0.6 - 0.8 0.8 - 1.0	Grill insert with ceramic tray	4	Brush chilled chicken pieces with oil and spices. Put on grill insert with ceramic tray with the skin-side down. Turn over, as soon as the oven beeps. After cooking let stand for 2 minutes.
7	Whole Chicken	0.8 - 0.9 1.0 - 1.1 1.2 - 1.3 1.4 - 1.5	Grill insert with ceramic tray	3	Brush chilled chicken with oil and spices and put breast-side-down on the grill insert with ceramic tray. Turn over, as soon as the oven beeps. After cooking let stand for 5 minutes.
8	Beef Steaks	0.3 - 0.6 0.6 - 0.8	Grill insert with ceramic tray	4	Put beef steaks side by side in the middle of grill insert with ceramic tray.

Using Speed Menu Mode (continued)

EN

No	Food Item	Weight/kg	Accessory	Shelf Level	Recommendation
9	Roast Beef	0.7 - 0.8 0.9 - 1.0 1.1 - 1.2 1.3 - 1.5	Grill insert with ceramic tray	3	Marinate roast beef and put on grill insert, set on ceramic tray with the fat side down. Turn over as soon as the oven beeps. After cooking wrap in aluminium foil and let stand for 5-10 minutes.
10	Baked Potatoes	0.2 - 0.4 0.4 - 0.6 0.6 - 0.8 0.8 - 1.0	Grill insert with ceramic tray	4	Wash and clean potatoes and pierce with a fork. Put potatoes (each 200 - 250 g) side by side on grill insert with ceramic tray. After cooking let stand for 3 - 5 minutes.
11	Cake	0.5 - 0.6 0.7 - 0.8 0.9 - 1.0	Ceramic tray	3	Put dough into suitable sized round glass pyrex baking dish. This programme is suitable for batter such as marble cake, lemon cake and hazelnut cake.
12	Muffins	0.5 - 0.6 0.7 - 0.8	Oven rack	3	Put muffin dough in metal muffin dish, suitable for 12 muffins. Set dish on oven rack. 0.5 - 0.6 kg weight range is recommended for muffins of each 45 g, 0.7 - 0.8 kg weight range is recommended for medium sized muffins of each 65 g.

Important

Most of Speed Menu Mode settings use microwave energy to heat food. Therefore guidelines for cookware and other microwave safety precautions must be strictly observed when using this mode.

Warning: When the appliance is operated in the combination mode, children should only use the oven under adult supervision due to the temperatures generated.

Using Speed Defrost Mode

EN

Setting Speed Defrost Mode

Choose from five pre-programmed microwave settings for defrosting. Defrosting time and power level are automatically set. Simply select the setting and weight to start defrosting.

Open the door. Place the frozen food in the centre of the ceramic tray. Position is level 1. Close the door.

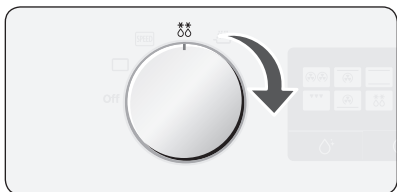

1 Turn **MODE SELECTOR** to the **Speed Defrost** (**) symbol.

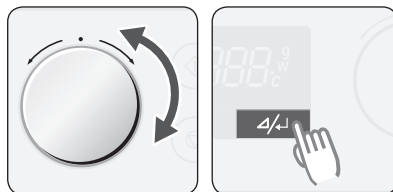

2 Turn **MULTI-FUNCTION SELECTOR** to choose desired defrost item. Press **POWER LEVEL / ENTOR** to set desired defrost item. (Refer to table on page 26 for a description of the 5 Speed Defrost settings.)

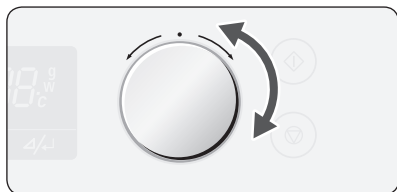

3 Select the food weight by turning the **MULTI-FUNCTION SELECTOR**.

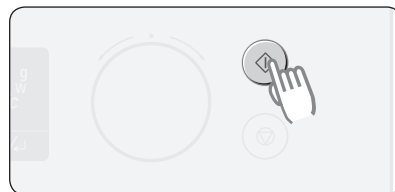

4 Press **START** to start cooking.

When cooking has finished, the oven will beep and flash "End" four times. The oven will then beep one time per minute for 3 minutes.

Result

- ◆ Defrosting begins.
- ◆ The oven beeps half way through defrosting to remind you to turn the food over.

Important

- Use only containers that are microwave - safe.
- You can also defrost food manually. To do so, select the microwave Cooking / Reheating function with a power level of 180 W. Refer to the section entitled "Cooking / Reheating" on page 35 for further details.

Using Speed Defrost Mode (Continued)

EN

Guide to Auto Speed Defrost Settings

The following table presents the various Auto Defrost programmes, quantities, standing times and appropriate recommendations. These programmes use microwave energy only. Remove all packaging material before defrosting. Place meat, poultry and fish on the ceramic tray.

No	Food Item	Weight (kg)	Accessory	Shelf Level	Standing Time (min)	Instructions
1	Meat	0.2 - 2.0	Ceramic tray	1	20 – 90	Shield the edges with aluminium foil. Turn the meat over, when the oven beeps. This programme is suitable for beef, lamb, pork, steaks, chops, minced meat.
2	Poultry	0.2 - 2.0	Ceramic tray	1	20 – 90	Shield the leg and wing tips with aluminium foil. Turn the poultry over, when the oven beeps. This programme is suitable for whole chicken as well as for chicken portions.
3	Fish	0.2 - 2.0	Ceramic tray	1	20 – 60	Shield the tail of a whole fish with aluminium foil. Turn the fish over, when the oven beeps. This programme is suitable for whole fishes as well as for fish fillets.
4	Bread / Cake	0.1 - 1.0	Ceramic tray	1	10 – 30	Put bread on a piece of kitchen paper and turn over, as soon as the oven beeps. Place cake on ceramic tray and if possible, turn over, as soon as the oven beeps. (Oven keeps operating and is stopped, when you open the door.) This programme is suitable for all kinds of bread, sliced or whole, as well as for bread rolls and baguettes. Arrange bread rolls in a circle. This programme is suitable for all kinds of yeast cake, biscuit, cheese cake and puff pastry. It is not suitable for short / crust pastry, fruit and cream cakes as well as for cake with chocolate topping.
5	Fruit	0.1 - 1.0	Ceramic tray	1	5 – 15	Distribute frozen fruit evenly on ceramic tray. This programme is suitable for fruits like raspberries, mixed berries, and tropical fruits.

Important

The Speed Defrost Mode uses microwave energy to heat food.

Therefore guidelines for cookware and other microwave safety precautions must be strictly observed when using this mode.

How a Microwave Oven Works

EN

Microwaves are high-frequency electromagnetic waves; the energy released enables food to be cooked or reheated without changing either the form or the colour.

You can use your microwave to:

- *Defrost*
- *Cook*

Cooking Principle

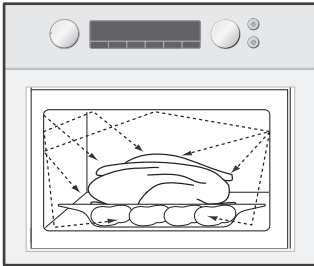

1. The microwaves generated by the magnetron are distributed uniformly by using stirrer distribution system. The food is thus cooked evenly.
2. The microwaves are absorbed by the food up to a depth of about 1 inch (2.5 cm). Cooking then continues as the heat is dissipated within the food.
3. Cooking times vary according to the container used and the properties of the food:
 - Quantity and density
 - Water content
 - Initial temperature (Refrigerated or not)

Important

As the centre of the food is cooked by heat dissipation, cooking continues even when you have taken the food out of the oven.

Standing times specified in recipes and in this booklet must therefore be respected to ensure:

- Even cooking of the food right to the centre
- The same temperature throughout the food

Using Microwave Mode

EN

Microwaves are high frequency electromagnetic waves. In microwave cooking, microwave energy penetrates food, attracted and absorbed by its water, fat and sugar content. The microwaves cause the molecules in the food to move rapidly. The rapid movement of these molecules creates friction and the resulting heat cooks the food.

Setting Microwave Mode

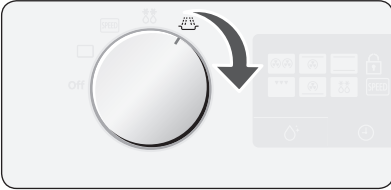

- 1** Turn **MODE SELECTOR** to microwave position. Time and power level will appear on **DISPLAY**.

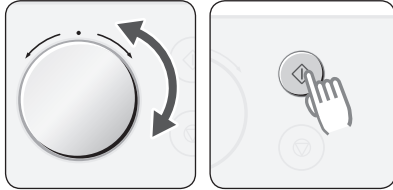

- 2** Turn **MULTI-FUNCTION SELECTOR** to set desired cooking time. When cooking time is set, **START** will blink. If you do not wish to change power level, press **START** to start cooking.

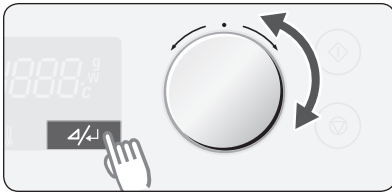

- 3** To change power level, press **POWER LEVEL / ENTER** and turn **MULTI-FUNCTION SELECTOR** to desired level. Refer to Cooking Guides (pages 32 to 37) for guidelines on appropriate cooking times and power levels.

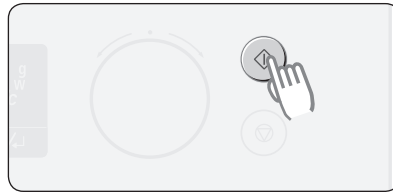

- 4** Press **START** to start cooking.

Using Microwave Mode (Continued)

Guide to Microwave Power Levels

POWER LEVEL	PERCENTAGE (%)	OUTPUT POWER (W)	REMARK
HIGH	100	900	For heating up liquids.
HIGH LOW	83	750	For heating up and cooking food.
MEDIUM HIGH	67	600	For heating up and cooking food.
MEDIUM	50	450	For cooking meat and heating up delicate foods.
MEDIUM LOW	33	300	For cooking meat and heating up delicate foods.
DEFROST	20	180	For defrosting and continued cooking.
LOW	11	100	For defrosting delicate foods.

EN

Using Microwave Mode (Continued)

EN

Microwave Cookware Guide

Cookware used for Microwave Mode must allow microwaves to pass through and penetrate food. Metals such as stainless steel, aluminum and copper reflect microwaves. Therefore, do not use cookware made of metallic materials. Cookware marked microwave-safe is always safe for use. For additional information on appropriate cookware refer to following guide and always use ceramic tray on shelf Level 1 when using microwave mode.

COOKWARE	MICROWAVE-SAFE	COMMENTS
Aluminium Foil	✓X	Can be used in small quantities to protect areas against overcooking. Arcing can occur if the foil is too close to the oven wall or if too much foil is used.
Crusting Plate	✓	Do not preheat for more than 8 minutes.
China and Earthenware	✓	Porcelain, pottery, glazed earthenware and bone china are usually suitable, unless decorated with a metal trim.
Disposable Polyester Cardboard Dishes	✓	Some frozen foods are packaged in these dishes.
Fast-food Packaging		
<ul style="list-style-type: none"> • Polystyrene cups containers 	✓	Can be used to warm food. Overheating may cause the polystyrene to melt.
<ul style="list-style-type: none"> • Paper bags or newspaper 	X	May catch fire.
<ul style="list-style-type: none"> • Recycled paper or metal trims 	X	May cause arcing.
Glassware		
<ul style="list-style-type: none"> • Oven-to-table ware 	✓	Can be used, unless decorated with a metal trim. Can be used to warm foods or liquids. Delicate glass may break or crack if heated suddenly.
<ul style="list-style-type: none"> • Fine glassware 	✓	
<ul style="list-style-type: none"> • Glass jars 	✓	
Metal		
<ul style="list-style-type: none"> • Dishes 	X	May cause arcing.
<ul style="list-style-type: none"> • Freezer bag twist ties 	X	

Using Microwave Mode (Continued)

EN

COOKWARE	MICROWAVE-SAFE	COMMENTS
Paper		
<ul style="list-style-type: none"> Plates, cups, napkins and Kitchen paper 	✓	For short cooking times and warming. Also to absorb excess moisture.
<ul style="list-style-type: none"> Recycled paper 	✗	May cause arcing.
Plastic		
<ul style="list-style-type: none"> Containers 	✓	Particularly if heat-resistant thermoplastic. Some other plastics may warp or discolour at high temperatures. Do not use Melamine plastic.
<ul style="list-style-type: none"> Cling film 	✓	Can be used to retain moisture. Should not touch the food. Take care when removing the film as hot steam will escape.
<ul style="list-style-type: none"> Freezer bags 	✓✗	Only if boilable or oven-proof. Should not be airtight. Prick with a fork, if necessary.
Wax or Grease-proof Paper	✓	Can be used to retain moisture and prevent spattering.

Note

“Arcing” is the microwave term for sparks in the oven.

- ✓ : Recommended
- ✓✗ : Use Caution
- ✗ : Unsafe

Using Microwave Mode (Continued)

EN

Microwave Cooking Guide

GENERAL GUIDELINES

Food Suitable for Microwave Cooking

Many kinds of food are suitable for microwave cooking, including fresh or frozen vegetables, fruit, pasta, rice, grains, beans, fish, and meat. Sauces, custard, soups, steamed puddings, preserves, and chutneys can also be cooked in a microwave oven. Generally speaking, microwave cooking is ideal for any food that would normally be prepared on a hob.

Covering During Cooking

Food should be covered during cooking, as the evaporated water rises as steam and contributes to cooking process. Food can be covered in different ways such as with a ceramic plate, plastic cover or microwave suitable cling film.

Standing Times

After cooking, it is important to let food stand for recommended standing time to allow the temperature to even out within the food.

COOKING GUIDE FOR FROZEN VEGETABLES

Use a suitable glass Pyrex bowl with lid. Cook covered for the minimum time (see table). Continue cooking to get the result you prefer. Stir twice during cooking and once after cooking. Add salt, herbs or butter after cooking. Keep covered during standing time.

Food	Portion (g)	Power (W)	Time (Min)	Standing Time (Min)	Instructions
Spinach	150	600	5 - 6	2-3	Add 15 ml (1 tbsp) cold water.
Broccoli	300	600	8 - 9	2-3	Add 30 ml (2 tbsp.) cold water.
Peas	300	600	7 - 8	2-3	Add 15 ml (1 tbsp.) cold water.
Green Beans	300	600	7½ - 8½	2-3	Add 30 ml (2 tbsp.) cold water.
Mixed Vegetables (Carrots / peas / corn)	300	600	7 - 8	2-3	Add 15 ml (1 tbsp.) cold water.
Mixed Vegetables (Chinese style)	300	600	7½ - 8½	2-3	Add 15 ml (1 tbsp.) cold water.

Using Microwave Mode (Continued)

EN

COOKING GUIDE FOR FRESH VEGETABLES

Use a suitable glass Pyrex bowl with lid. Add 30 - 45 ml cold water (2 - 3 tbsp) for every 250 g unless another water quantity is recommended (see table). Cook covered for the minimum time (see table). Continue cooking to get the result you prefer. Stir once during and after cooking.

Add salt, herbs or butter after cooking. Cover during the 3 minute standing time.

Hint : Cut fresh vegetables into even sized pieces. The smaller they are cut the quicker they are cooked.

Note : All fresh vegetables should be cooked using full microwave power (900 W).

Food	Portion (g)	Time (Min)	Standing Time (Min)	Instructions
Broccoli	250	3 - 4	3	Prepare even sized florets. Arrange stems to the centre.
	500	6 - 7		
Brussels Sprouts	250	5 - 6	3	Add 60-75 ml (4 - 5 tbsp.) water.
Carrots	250	4 - 5	3	Cut carrots into even sized slices.
Cauliflower	250	4 - 5	3	Prepare even sized florets. Cut big florets into halves. Arrange stems to the centre.
	500	7 - 8		
Courgettes	250	3 - 4	3	Courgettes into slices. Add 30ml (2 tbsp) water or a knob of butter. Cook until just tender.
Egg Plants	250	3 - 4	3	Cut egg plants into small slices and sprinkle with 1 tablespoon lemon juice.
Leeks	250	3 - 4	3	Cut leeks into thick slices.
Mushrooms	125	1 - 2	3	Prepare small whole or sliced mushrooms. Do not add any water. Sprinkle with lemon juice. Spice with salt and pepper. Drain before serving.
	250	2 - 3		
Onions	250	4 - 5	3	Cut onions into slices or halves. Add only 15 ml (1 tbsp) water.
Pepper	250	4 - 5	3	Cut pepper into small slices.
Potatoes	250	4 - 5	3	Weigh the peeled potatoes and cut them into similar sized halves or quarters.
	500	7 - 8		
Turnip Cabbage	250	5 - 6	3	Cut turnip cabbage into small cubes.

Using Microwave Mode (Continued)

EN

COOKING GUIDE FOR RICE AND PASTA

Rice Use a large glass Pyrex bowl with lid. (Note that rice doubles in volume during cooking.) Cook covered. After cooking time is over, stir before letting stand. Add salt or herbs and butter. Note that rice may not have absorbed all water after the cooking time is finished.

Pasta Use a large glass Pyrex bowl. Add boiling water, a pinch of salt and stir well. Cook uncovered. Stir occasionally during and after cooking. Cover during standing time and drain thoroughly afterwards.

Food	Portion (g)	Power (W)	Time (Min)	Standing Time (Min)	Instructions
White Rice (Parboiled)	250 375	900	15 - 16 17½ - 18½	5	Add 500 ml cold water. Add 750 ml cold water
Brown Rice (Parboiled)	250 375	900	20 - 21 22 - 23	5	Add 500 ml cold water. Add 750 ml cold water
Mixed Rice (Rice + Wild Rice)	250	900	16 - 17	5	Add 500 ml cold water.
Mixed Corn (Rice + Grain)	250	900	17 - 18	5	Add 400 ml cold water.
Pasta	250	900	10 - 11	5	Add 1000 ml hot water.

REHEATING

Your microwave oven will reheat food in a fraction of the time a conventional oven takes.

Arranging and Covering

Avoid reheating large items such as joints of meat since they tend to overcook and dry out before the centre is piping hot. You will have more success reheating smaller pieces. Keeping food covered while heating will also help prevent drying.

Power Levels

Different power levels can be used for reheating foods.

In general, for large quantities of delicate food or foods that heat up quickly, such as mince pies, it is better to use a lower power level.

Stirring

Stir well or turn food over during reheating for best results. When possible, stir again before serving. Stirring is especially important when heating liquids.

Heating and Standing Times

When reheating food for the first time, it is helpful to make a note of the time taken for future reference. Avoid overheating. If uncertain, it is preferable to underestimate cooking time. Then extra heating time can be added, if necessary. Always make sure that reheated food is piping hot throughout. Allow food to stand for a short time after reheating to let the temperature even out. The recommended standing time after reheating is 2-4 minutes

Using Microwave Mode (Continued)

EN

REHEATING LIQUIDS

Take special care when heating liquids. To prevent eruptive boiling and possible scalding, place a spoon or glass stick in the beverage. Stir during heating and always stir after heating. Allow a standing time of at least 20 seconds after the oven has been switched off to allow the temperature to even out.

REHEATING BABY FOOD

Baby Food

Extra caution should also be exercised when reheating baby foods. Put food into deep ceramic plate. Cover with plastic lid. Stir well after reheating. Let stand for 2 - 3 minutes before serving. Stir again and check temperature. Recommended serving temperature is between 30 – 40 °C.

Baby Milk

Pour milk into a sterilised glass bottle. Reheat uncovered. Never heat a baby's bottle with nipple on, as the bottle may explode if overheated. Shake well before standing time and again before serving. Always carefully check the temperature of baby milk or food before serving. Recommended serving temperature is 37 °C.

DEFROSTING

Microwaves are an excellent way of defrosting frozen food. Microwaves gently defrost frozen food in a short period of time. This can be a great advantage, if unexpected guests suddenly show up.

Frozen poultry must be thoroughly thawed before cooking. Remove any metal ties and take it out of any wrapping to allow thawed liquid to drain away.

Put the frozen food on a dish without cover. Turn over half way, drain off any liquid and remove any giblets as soon as possible.

Check the food occasionally to make sure that it does not feel warm.

If smaller and thinner parts of the frozen food start to warm up, they can be shield by wrapping very small strips of aluminium foil around them during defrosting.

Should poultry start to warm up on the outer surface, **STOP / CANCEL** thawing and allow it to stand for 20 minutes before continuing.

Leave the fish, meat and poultry to stand in order to complete defrosting.

The standing time for complete defrosting will vary depending on the quantity defrosted.

Please refer to the table on the next page.

Hint Flat food is defrosted better than thicker items, and smaller quantities need less time than bigger ones. Remember this hint while freezing and defrosting food.

For defrosting of frozen food with a temperature of about -18 to -20 °C, use the following table as a guide.

Frozen foods should be defrosted using defrosting power level (180 W).

Using Microwave Mode (Continued)

EN

Food	Portion	Time (Min)	Standing Time (Min)	Instructions
Meat				
Minced Beef	250 g	6 - 7	15 - 30	Place the meat on the ceramic plate. Shield thinner edges with aluminium foil. Turn over after half of defrosting time!
	500 g	10 - 12		
Pork Steaks	250 g	7 - 8		
Poultry				
Chicken Pieces	500 g (2 pcs)	12 - 14	15 - 60	First, put chicken pieces first skin-side down, whole chicken breast-side-down on ceramic plate. Shield the thinner parts like wings and ends with aluminium foil. Turn over after half of defrosting time
Whole Chicken	1200 g	28 - 32		
Fish				
Fish Fillets	200 g	6 - 7	10 - 25	Put frozen fish in the middle of ceramic plate. Arrange the thinner parts under the thicker parts. Shield narrow ends of fillets and tail of whole fish With aluminium foil. Turn over after half of defrosting time!
Whole Fish	400 g	11 - 13		
Fruit				
Berries	300 g	6 - 7	5 - 10	Spread fruit on a flat, round glass dish with a large diameter.
Bread				
Bread Rolls (Each ca. 50 g)	2 pcs 4 pcs	1 - 1½ 2½ - 3	5 - 20	Arrange rolls in a circle or bread horizontally on kitchen paper on the ceramic plate. Turn over after half of defrosting time.
Toast / Sandwich	250 g	4 - 4½		
	500 g	7 - 9		

Using Microwave Mode (Continued)

EN

QUICK & EASY

Melting Butter

Put 50 g of butter into a small deep glass dish. Cover with plastic lid.

Heat for 30 - 40 seconds using 900 W.

Melting Chocolate

Put 100 g of chocolate into a small deep glass dish.

Heat for 3 - 5 minutes using 450 W.

Stir once or twice during melting.

Melting Crystallized Honey

Put 20 g crystallized honey into a small deep glass dish.

Heat for 20 - 30 seconds using 300 W.

Melting Gelatine

Place dry gelatine sheets (10 g) in cold water for 5 minutes.

Put drained gelatine into a small glass Pyrex bowl.

Heat for 1 minute using 300 W.

Stir after melting.

Cooking Glaze or Icing

Mix instant glaze (approximately 14 g) with 40 g of sugar and 250 ml of cold water.

Cook uncovered in a glass Pyrex bowl using 900 W until glaze/icing is transparent (about 3½ to 4½ minutes). Stir twice during cooking.

Cooking Jam

Put 600 g of fruits such as mixed berries in a suitably sized glass Pyrex bowl.

Add 300 g of preserving sugar and stir well.

Cook covered for 10 - 12 minutes using 900 W.

Stir several times during cooking.

Empty directly into small jam glasses with twist-off lids.

Let it stand with lid on for 5 minutes.

Cooking Pudding

Mix pudding powder with sugar and milk (500 ml) by following the manufacturers instructions and stir well. Use a suitable sized glass Pyrex bowl with lid.

Cook covered for 6½ to 7½ minutes using 900 W.

Stir several times during cooking.

Browning Almond Slices

Spread 30 g sliced almonds evenly on a medium-sized ceramic plate.

Heat for 3½ to 4½ minutes using 600 W, stirring several times.

Let stand for 2 to 3 minutes in the oven.

Switching Off the Beeper

EN

The oven beeps at the end of cooking, “End” blinks 4 times on the display.



1 To switch beeper off, press **STOP / CANCEL** (⬠) and **START** (⬇) at the same time and hold for one second.



2 To switch beeper back on, press **STOP / CANCEL** (⬠) and **START** (⬇) again at the same time and hold for one second.

Child Safety Lock

The oven's Child Safety Lock allows you to lock the control panel to protect the oven against unintended use.

EN

To Lock Oven



1 Press **STEAM CLEAN** and **CLOCK** at the same time and hold for 3 seconds.

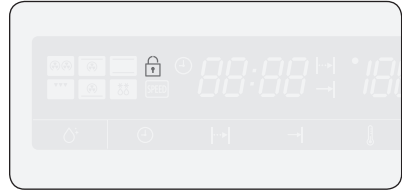

2 Lock symbol appears on DISPLAY indicating all functions locked.

To Unlock Oven



1 Press **STEAM CLEAN** and **CLOCK** at the same time and hold for 3 seconds.

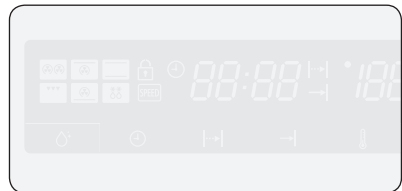

2 Lock symbol disappears indicating functions unlocked.

Using the Steam Clean Feature

The Steam Clean feature allows you to sanitize your oven in just 15 minutes.

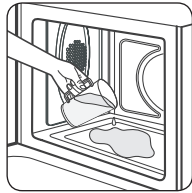
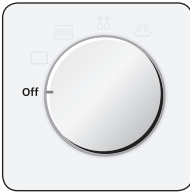

- 1 Turn **MODE SELECTOR** to "Off" position.
 - ▶ Pour about 100 ml water onto the floor of the empty oven.

- 2 Press **STEAM CLEAN**. The oven will start automatically.
 - ▶ After 15 minutes, the oven will stop automatically. Wipe it out with a dry cloth.

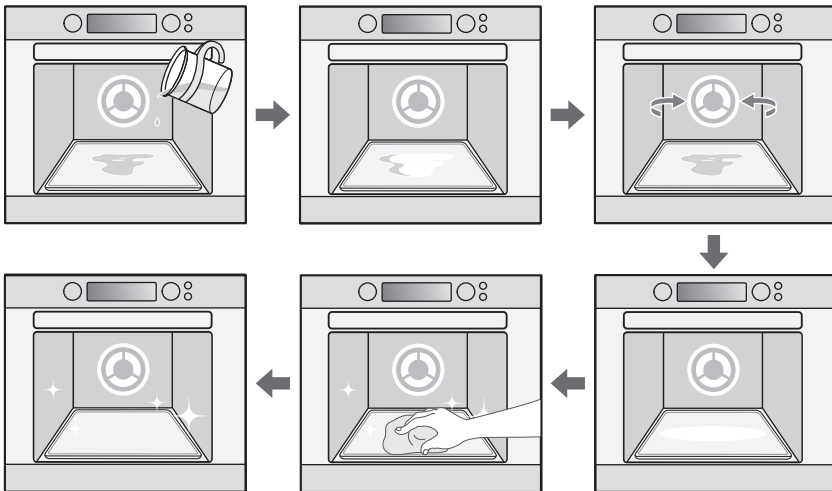

Important

- Use this feature only when oven has cooled completely to room temperature.
- Do NOT use distilled water.
- Do NOT use high-pressure water cleaners or steam jet cleaners for safety reasons.

Cleaning Your Microwave Oven

Clean your oven regularly to prevent grease and food particles from building up, especially on inside and outside surfaces, door and door seals.

1. Clean outside surfaces with a soft cloth and warm soapy water. Rinse and dry.
2. Remove any splashes or stains on inside surfaces with a soapy cloth. Rinse and dry.
3. To loosen hardened food particles and remove smells, place a cup of diluted lemon juice on the floor of the empty oven and heat for ten minutes at maximum power.
4. Wash the inside.

Important

- Take special care NOT to spill water in the vents.
- NEVER use abrasive products or chemical solvents.
- ALWAYS ensure that door seals are clean to prevent particles from building up so that the door can close properly.

Storing and Repairing Your Microwave Oven

Repairs should only be made by a qualified service technician.

If oven requires servicing, unplug the oven and contact the nearest Samsung Customer Service Center.

When calling, please have the following information ready:

- ***The model number and serial number (Can be found at rear of the oven.)***
- ***Warranty details***
- ***Clear description of the problem***

If oven must be temporarily stored, choose a clean dry place as dust and dampness can cause damage.

Troubleshooting

EN

If you have problems with your oven, try the solutions suggested below. They may save you the time and inconvenience of an unnecessary service call.

- ◆ Food remains uncooked.
 - Ensure timer has been set correctly and START button pressed.
 - Firmly close door.
 - Make sure you have not blown a fuse or triggered a circuit breaker.
- ◆ Food is either overcooked or undercooked.
 - Make sure appropriate cook time was used.
 - Make sure appropriate power level was used.
- ◆ Sparking and cracking (arcing) occur inside the oven.
 - Make sure you are using proper cookware without metal trimmings.
 - Make sure no forks or other metal utensils have been left inside the oven.
 - If using aluminum foil, make sure it is not too close to inside walls.
- ◆ The oven causes interference with radios or televisions.
 - Slight interference on televisions or radios may occur when the oven is operating. To minimize this effect, try to install oven away from televisions, radios and aerials.
- ◆ Electronic interference causes DISPLAY to be reset.
 - Disconnect the power plug and reconnect it. Reset the time.
- ◆ Condensation appears inside the oven.
 - This is a normal occurrence. Simply wipe away after cooking.
- ◆ The fan continues to operate after the oven has been turned off.
 - This is a normal occurrence. Cooling fan may continue to operate for up to three minutes after oven has been turned off.
- ◆ Air flow is detected around the door and outer casing.
 - This is a normal occurrence.
- ◆ Light reflection around the door and outer casing.
 - This is a normal occurrence.
- ◆ Steam escapes from around the door or vents.
 - This is a normal occurrence.
- ◆ A clicking sound occurs while the oven is operating, especially in defrosting mode.
 - This is a normal occurrence.

Error Code

EN

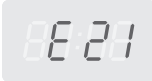
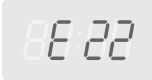
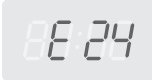
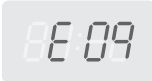
Error Code	General Functions
	TEMP SENSOR OPEN In case the value of a temperature sensor is more than 250 °C during operation / cancellation.
	TEMP SENSOR SHORT In case the value of a temperature sensor is less than 5 °C during operation / cancellation.
	OVER 210 °C DURING OPERATION OF MWO In case the temperature rises over 210 °C during operation of MWO (FIRE sensed)
	DAMPER S/W In case it fails to sense DAMPER whether to open or close for 2 minutes.

Technical Specifications

“Samsung strives to improve its products at all times. Both the design specifications and these user instructions are thus subject to change without notice.”

Model	FQ159ST (Display Color Orange) FQ159UST (Display Color Blue)
Power Source	240V ~ 50 Hz
Power Consumption Maximum power Microwave Top Grill Dual Convection	3400 W 1650 W 2900 W 3300 W
Output Power	100 W / 900 W (IEC - 705)
Operating Frequency	2450 MHz
Magnetron	OM75P (20)
Cooling Method	Cooling fan motor
Dimensions (W x H x D) Outside Oven cavity	595 x 460 x 520 mm 429 x 229 x 430 mm
Volume	42 liter
Weight Net Shipping	37 kg approx 46 kg approx





ELECTRONICS

**If you have any questions or comments relating to Samsung products,
please contact the SAMSUNG customer care center.**

Tel : 1300 362 603
www.samsung.com/au

Free Manuals Download Website

<http://myh66.com>

<http://usermanuals.us>

<http://www.somanuals.com>

<http://www.4manuals.cc>

<http://www.manual-lib.com>

<http://www.404manual.com>

<http://www.luxmanual.com>

<http://aubethermostatmanual.com>

Golf course search by state

<http://golfingnear.com>

Email search by domain

<http://emailbydomain.com>

Auto manuals search

<http://auto.somanuals.com>

TV manuals search

<http://tv.somanuals.com>