



# Wireless Audio Portable user manual

---

Thank you for purchasing this Samsung product. To receive more complete service, please register your product at

[www.samsung.com/register](http://www.samsung.com/register)

---

**DA-F60/DA-FM60C**

## WHAT'S INCLUDED

Check for the supplied accessories shown below. The appearance of the accessories may differ slightly from the illustrations.



**Power Adapter**  
(BN44-00659A)

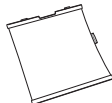

**Cover Fabric**  
(AH96-02524A)



**User Manual**  
(AH68-02622A)

### Using the Cover Fabric

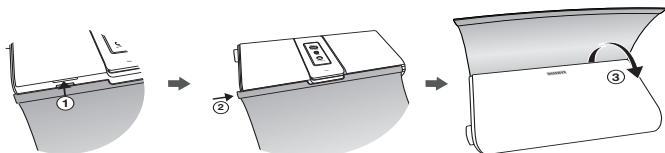

Wrap the cover around the product. The cover will be held in place by magnets.

## YOUR WIRELESS AUDIO PORTABLE

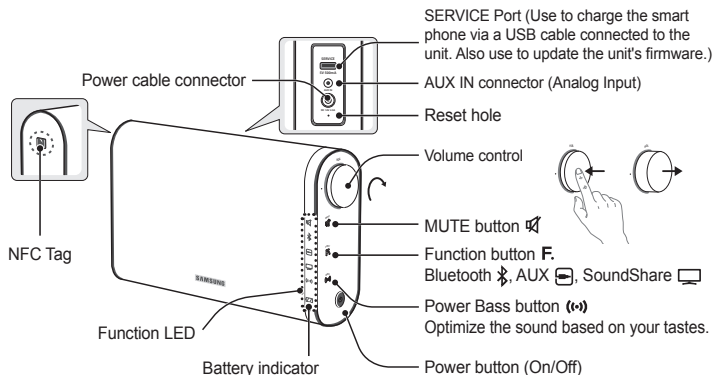

- ▶ When you charge smart phone via USB, the battery may discharge more quickly.
  - Charging smart phone through the Service (USB) port takes longer than charging the unit using the adapter. It is only chargeable when this product is turned on.

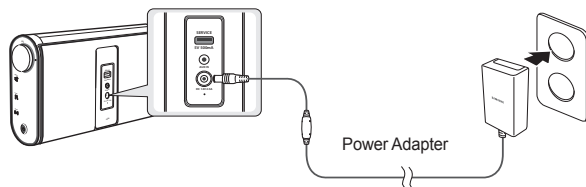

### Charge the battery

The battery status indicator is normally off to conserve battery power. To check the charge level, press and hold the Power button for 5 seconds. You can play this product for 12 hours continuously on one charge. For a full charge, we recommend you charge the battery for about 3 hours.



- OFF ..... Full charge
- Green ..... 60% to 99% of full charge
- Yellow ..... 30% to 60% of full charge
- Red ..... 30% or less
- Red blink ..... Charge needed

### Support

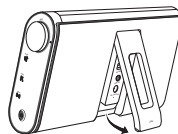

Don't pull the support too hard. You can damage it.

- ▶ We recommend you charge the battery for 3 hours.
- ▶ Charge and store the battery at 41° F ~ 95° F.
- ▶ Do not charge the battery for more than 12 hours or leave the battery fully discharged for a long time. Doing so may shorten the battery life.
- ▶ Depending on how you use your player, actual battery life may vary and may be shorter than specified.

### Reset your Product

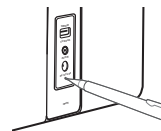

If an error occurs while you are operating this product and it doesn't work properly, press the Reset hole with a pen tip or similar item for 2 seconds.

## USING THE NFC FUNCTION

Connect your NFC compatible device via Bluetooth to the Wireless Audio Portable using this simple set-up procedure and play music on the device through the Wireless Audio Portable.

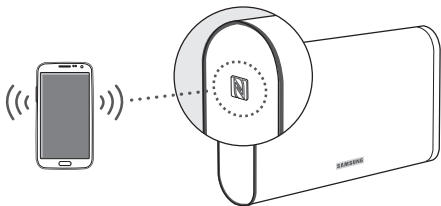

1. Turn on the NFC function on the device and make sure the screen lock function on the device is off. The device's NFC function will not work if screen lock is on.
2. Gently touch the top of the Wireless Audio Portable's left panel with the NFC supported device.
  - If the Wireless Audio Portable is off, it will turn on automatically.
3. A pop-up asking whether to proceed with the Bluetooth connection appears on the device. Select **<Yes>**.
  - When the connection is complete, the 'connected' message appears.
4. To disconnect the NFC device, touch the device to the Wireless Audio Portable's left panel again. To connect another NFC device while the first device is still connected, touch that device to the Wireless Audio Portable's left panel. The Wireless Audio Portable will disconnect the first device and connect to the second device.

- ▶ The NFC function is built into Android devices running Android OS 4.1 Jellybean or later.
  - If your device is running an Android OS earlier than Android OS 4.1 Jellybean, you must download the 'Samsung NFC Connection' application from Android market to use the NFC function.
- ▶ The position of the NFC antenna differs on devices. Check where the NFC antenna is located before connecting.
- ▶ If your device is covered with a thick case, the connection may not succeed.

## USING BLUETOOTH

You can connect the Wireless Audio Portable to Bluetooth devices and enjoy music with high quality stereo sound, all without wires!

Bluetooth technology lets Bluetooth-compliant devices interconnect easily with each other using a short wireless connection.

- A Bluetooth device may cause noise or malfunction, depending on usage, when:
  - A part of your body is in contact with the receiving/transmitting system of the Bluetooth device or the Wireless Audio Portable.
  - It is subject to electrical variation from obstructions caused by a wall, corner, or by office partitioning.
  - It is exposed to electrical interference from same frequency-band devices including medical equipment, microwave ovens, and wireless LANs.
- Pair the Wireless Audio Portable with the Bluetooth device while they are close together.
- The further the distance between the Wireless Audio Portable and Bluetooth device, the worse the quality. If the distance exceeds the Bluetooth operational range, the connection is lost.
- The Bluetooth connection only works when the Bluetooth device is close to the set. The connection is automatically cut off if the Bluetooth device moves out of range. Even within range, the sound quality may be degraded by obstacles such as walls or doors.
- This wireless device may cause electric interference during its operation.

## To connect the Wireless Audio Portable to a Bluetooth device

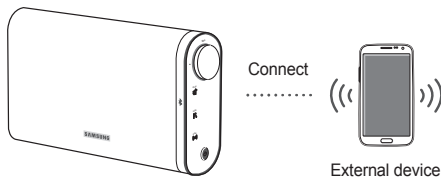

**aptX®**  
aptX enables high quality Bluetooth stereo audio that delivers wired audio quality wirelessly.

1. Press the **BT** button on the Wireless Audio Portable to select the Bluetooth function.
2. Press the **BT** button for 3 seconds in Bluetooth mode.
3. The Bluetooth indicator blinks quickly and the product changes to the pairing mode.
4. Scan or Search for the Wireless Audio Portable on your Bluetooth device.
5. Select **"[Samsung] W\_Audio"** on the list of items found by the Bluetooth device.
  - If the Bluetooth device fails to pair with the Wireless Audio Portable, repeat Steps 2, 3, and 4.
6. Play music on the connected device.

- ▶ In Bluetooth connection mode, the Bluetooth connection will be lost if the distance between the Wireless Audio Portable and the Bluetooth device exceeds 16.25 ft (5m).

- ▶ You may be required to enter a PIN code (password) when connecting the Bluetooth device to the Wireless Audio Portable. If the PIN code input window appears, enter <0000>.
- ▶ The Wireless Audio Portable supports SBC data (44.1kHz, 48kHz).
- ▶ The AVRCP feature is not supported.
- ▶ Connect only to a Bluetooth device that supports the A2DP (AV) function.
- ▶ You cannot connect to a Bluetooth device that supports only the HF (Hands Free) function.
- ▶ Only one Bluetooth device can be paired at a time.

## USING THE SOUNDSHARE FUNCTION

This section explains how to connect the Wireless Audio Portable to Bluetooth compatible SAMSUNG TVs.

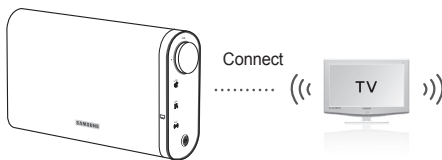

1. Turn on the Samsung TV and Wireless Audio Portable.
  - Set 'Add New Device' to 'On' in the TV's 'SoundShare Settings' menu. (Refer to the TV's user manual for details.)
2. Press the button to change the mode of the Wireless Audio Portable to . A message asking whether to proceed with Bluetooth pairing appears.
  - The blinks in the standby mode.
3. Select <Yes> on the TV screen. The Wireless Audio Portable pairs with the TV.
  - The indicator blinks, and then stops blinking.
  - The Wireless Audio Portable Bluetooth pairing is complete.
  - If you want to cancel an existing pairing and pair the Wireless Audio Portable to another TV, press the button for 3 seconds with the unit in mode.

- ▶ SoundShare is supported by some Samsung TVs released after 2012. Check whether your TV supports SoundShare before you begin.
- ▶ Optimal pairing distance is 3.3 feet or less.

## SOFTWARE UPGRADE

Samsung may offer upgrades for the Wireless Audio Portable's system firmware in the future. If an upgrade is offered, you can upgrade the firmware by connecting a USB drive with the firmware upgrade stored on it to the Service (USB) port on your Wireless Audio Portable.

Please visit [Samsung.com](http://Samsung.com) to receive more information about downloading upgrades files.

To upgrade after you have downloaded the firmware, follow these steps:

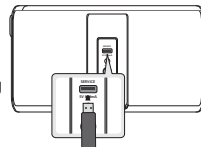

1. Turn on the product.
2. Insert a USB drive containing the firmware upgrade into the Service (USB) port on the back of the product.
3. Press the and buttons for 5 seconds at the same time. The update process starts.
  - All LEDs indicators will blink during the update process.
4. The LEDs will turn off automatically after the update process is complete.
  - Do not disconnect the power or remove the USB drive while upgrades are being applied.
  - The product will turn off automatically after completing the firmware upgrade.
  - When firmware is upgraded, settings you have made will return to their default (factory) settings. We recommend you write down your settings so that you can easily reset them after the upgrade.
  - When the battery indicator LED is red, do not update the product. Doing so could cause the product to malfunction.

- ▶ If the firmware fails to upgrade, we recommend formatting the USB drive in FAT16 and trying again.
- ▶ For upgrading purposes, do not format the USB drive in NTFS format because it is not a supported file system.
- ▶ Depending on the manufacturer, the USB may not be supported.

## CONNECTING AN AUDIO DEVICE USING AUX IN

This section explains how to connect the unit to an audio device. This unit requires one audio analog jack for connecting to an audio device.

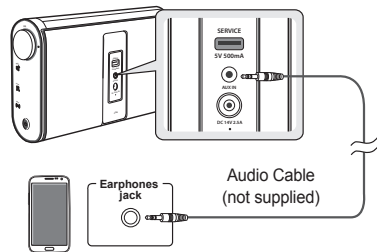

External device

Press the button to select AUX function.

- ▶ Before moving or installing this product, be sure to turn off the power and disconnect the power cord.

## TROUBLESHOOTING

Before requesting service, please try the following solutions:

### The unit will not turn on.

- Connect the power plug to the outlet.
- Your player will not turn on if the battery is completely drained. Recharge the battery and turn the player on again.
- Check if the battery is discharged.

### A function does not work when the button is pressed.

- Disconnect the power plug and connect it again.
- Check if the buttons correspond to the functions you want to activate.

### Sound is not produced.

- Make sure the unit is properly connected.
- Check if the Mute function is on.
- Check if the volume is set to minimum.

### The power of the unit is off.

- The unit automatically turns off in the following situations.
  - If there is no KEY input for 8 hours when the cable is connected in AUX mode.
  - If the AUX cable in AUX mode is disconnected for 25 minutes.
  - If the Bluetooth or SoundShare mode has been disconnected from this unit for 25 minutes.
  - It does not turn off when the smart phone is charging.

### Sound is not produced in AUX mode.

- Check the power of the external device and whether the music is playing or not.
- Make sure the AUX mode is selected.
- Check if the audio cable is connected properly.
- Turn up the volume of the product/external device.

### The SoundShare (TV pairing) failed.

- Check whether your TV supports SoundShare. (<http://www.samsung.com>)
- Check whether your TV has the latest firmware.
- Reset the unit.
- If the function doesn't work even though the connection is completed, contact the Samsung call center.

### The Wireless Audio Portable may not search or connect properly in the following cases.

- If there is a strong electrical field around the Wireless Audio Portable.
- If several Bluetooth devices are simultaneously paired to the Wireless Audio Portable.
- If the Bluetooth device is turned off, not in place, or malfunctions.

## OTHER NOTES

### About the Battery

- If the battery is nearly discharged, red indicator begins to blink and eventually turned off.
- If the battery has insufficient charges, pressing the power button does not turn on the product. Instead, the battery indicator blinks red a few times and turns off.
- While the battery indicator is blinking, all other buttons will not work.
- If the battery is fully discharged, all function, volume and bass settings are initialized.

BC

### About NFC

- NFC tagging for Bluetooth connection cannot be established while powering on and off.
- NFC tagging for Bluetooth connection will not work while the battery indicator is blinking.

### About Automatic Bluetooth Connection

- When switching to Bluetooth mode or powered up in Bluetooth mode, the last Bluetooth connection will be restored automatically if available. Automatic Bluetooth connection attempt will abort after 1 minute.
- Within the automatic connection trial, connection to another Bluetooth device can be limited. To connect to a different Bluetooth device, switch the product's Bluetooth mode to pairing mode. (See page 3.)

## SPECIFICATIONS

**Model name :** DA-F60/DA-FM60C

**Power supply :** DC 14V 2.5A

**Power consumption :** 23W

**Weight :** 2.42 lbs

**Dimensions (W x D x H) :**

8.8 x 1.8 x 5.2 inches

**Operating temperature range :**

+41°F to +95°F

**Operating humidity range :** 10 % to 75 %



- Samsung Electronics Co., Ltd reserves the right to change the specifications without notice.
- Weight and dimensions are approximate.
- Open the rear cover to check the label.

### Copyright

©2013 Samsung Electronics Co.,Ltd.

All rights reserved; no part or whole of this user's manual may be reproduced or copied without the prior written permission of Samsung Electronics Co.,Ltd.

## SAFETY WARNINGS

	<b>CAUTION</b> RISK OF ELECTRIC SHOCK DO NOT OPEN	
The lightning flash and arrowhead within the triangle indicates that there is dangerous voltage inside the product.	CAUTION: TO REDUCE THE RISK OF ELECTRIC SHOCK, DO NOT REMOVE THE COVER (OR BACK). NO USER SERVICEABLE PARTS INSIDE. REFER SERVICING TO QUALIFIED SERVICE PERSONNEL.	The exclamation point within the triangle indicates that there are important instructions accompanying the product.

### WARNING

- To reduce the risk of fire or electric shock, do not expose this appliance to rain or moisture.

### CAUTION

- Do not expose this apparatus to dripping or splashing. Do not put an object filled with liquid, such as a vase, on the apparatus.
- To turn this apparatus off completely, you must pull the power plug out of the wall socket. Consequently, the power plug must be easily and readily accessible at all times.

This product satisfies FCC regulations when shielded cables and connectors are used to connect the unit to other equipment. To prevent electromagnetic interference with electric appliances, such as radios and televisions, use shielded cables and connectors for connections.

### FCC NOTE (for U.S.A.):

This equipment has been tested and found to comply with the limits for a Class B digital device, pursuant to Part 15 of the FCC Rules. These limits are designed to provide reasonable protection against harmful interference in a residential installation.

This equipment generates, uses and can radiate radio frequency energy and, if not installed and used in accordance with the instructions, may cause harmful interference to radio communications. However, there is no guarantee that interference will not occur in a particular installation.

If this equipment does cause harmful interference to radio or television reception, which can be determined by turning the equipment off and on, the user is encouraged to try to correct the interference by one or more of the following measures:

- Reorient or relocate the receiving antenna.
- Increase the separation between the equipment and receiver.
- Connect the equipment to an outlet that is on a different circuit than the radio or TV.
- Consult the dealer or an experienced radio/TV technician for help.

Caution : FCC regulations state that any unauthorized changes or modifications to this equipment may void the user's authority to operate it.

## Important Safety Instructions

Read these operating instructions carefully before using the unit. Follow all the safety instructions listed below. Keep these operating instructions handy for future reference.

- 1) Read these instructions.
- 2) Keep these Instructions.
- 3) Heed all warnings.
- 4) Follow all instructions.
- 5) Do not use this apparatus near water.
- 6) Clean only with dry cloth.
- 7) Do not block any ventilation openings. Install in accordance with the manufacturer's instructions.
- 8) Do not install near any heat sources such as radiators, heat registers, stoves, or other apparatus (including amplifiers) that produce heat.
- 9) Do not defeat the safety purpose of the polarized or grounding-type plug. A polarized plug has two blades with one wider than the other. A grounding type plug has two blades and a third grounding prong. The wide blade or the third prong are provided for your safety. If the provided plug does not fit into your outlet, consult an electrician for replacement of the obsolete outlet.
- 10) Protect the power cord from being walked on or pinched particularly at plugs, convenience receptacles, and the point where they exit from the apparatus.
- 11) Only use attachment/accessories specified by the manufacturer.
- 12) Use only with the cart, stand, tripod, bracket, or table specified by the manufacturer, or sold with the apparatus. When a cart is used, use caution when moving the cart/apparatus combination to avoid injury from tip-over.
- 13) Unplug this apparatus during lightning storms or when unused for long periods of time.
- 14) Refer all servicing to qualified service personnel. Servicing is required when the apparatus has been damaged in any way, such as power-supply cord or plug is damaged, liquid has been spilled or objects have fallen into the apparatus, the apparatus has been exposed to rain or moisture, does not operate normally, or has been dropped.



## SAFETY PRECAUTIONS

### Power Supply Precautions

- Do not overload outlets or extension cords.
  - This may result in abnormal heat or fire.
- Do not plug in or unplug the power cord with wet hands.
- Do not place the product near heating equipment.
- To clean the power plug blades, remove the plug from the wall outlet and wipe the blades with a dry cloth only.
- Do not bend the power cord or pull it forcefully.
- Do not put heavy objects on the AC power adaptor.
- Do not use the AC adaptor if it is damaged. Do not disconnect the AC adaptor by pulling on its power-cord.
- Do not plug the power cord into a loose or damaged outlet.
- Fully insert the AC adaptor's plug into the wall outlet so that it's plug is firmly attached to the outlet.
  - If the connection is unstable, there is a risk of fire.

### Installation Precautions

- Do not install the product near equipment or objects that generate heat or produce fire (candles, mosquito coils, heaters, radiators, etc.). Do not install in direct sunlight.
- When moving the product, turn off the power and disconnect all cords (include the power cord) from the unit.
  - A damaged cord may cause a fire and poses a risk of electric shock.
- Installing the product in environments with high heat or humidity, dust, or extreme cold, can lead to quality problems or cause the product to malfunction. Before you install the product in an environment that is outside the norm, please contact the Samsung service center for additional information.
- Place the product upright when installing it on a shelf, cabinet, or desk. Do not place the product on an unstable surface (e.g. a shaky shelf, a tilted desk, etc.).
  - Dropping the product can cause it to malfunction and poses a risk of injury. Severe vibration or impact can also cause the product to malfunction and lead to a fire hazard.
- Install your product with enough space around it for the ventilation.
  - Leave at least 4 inches (10cm) at the rear of the product and more than 2 inches (5cm) on each side of the product.

- Keep the plastic packing materials out of reach of your children.
  - Children playing with the plastic packing materials run the risk of suffocation.

### Usage Precautions

- Using for an extended time at high volume may cause serious damage to your hearing.
  - If you are exposed to sound louder than 85db for an extended time, you may adversely affect your hearing. The louder the sound is, the more seriously damaged your hearing may become. Note that an ordinary conversation is between 50 to 60 db and road noise is approximately 80 db.
- This product contains dangerous high voltage. Do not attempt to disassemble, repair, or modify it yourself.
  - Contact a Samsung service center when your product is in need of repair.
- Do not place any container that contains liquid on the product (e.g. vase, beverages, cosmetics, chemicals, etc.). Do not allow any metal objects (e.g. coins, hair clips, etc.) or flammable material (e.g. paper, matches, etc.) to enter the product (through the air vents, I/O ports, etc.).
  - If any harmful material or liquid enters the product, turn off the product immediately, unplug the power cord, and then contact a Samsung service center.
- Do not drop the product. In case of a mechanical breakdown, disconnect the power cord and contact a Samsung service center.
  - There is a risk of fire or electric shock.
- Do not hold or pull the product by the power cord or the signal cable.
  - A damaged cable can cause the product to malfunction, cause a fire, and poses a risk of electric shock.
- Do not use or keep flammable materials near the product.
- If the product emits an abnormal sound or a burnt smell or smokes, unplug the power-cord immediately and contact a Samsung service center.
- If you smell gas, ventilate the room immediately. Do not touch the power plug of the product. Do not turn the product off or on.
- Do not strike or subject the product to a sudden shock. Do not pierce the product with a sharp object.

### Cleaning Precautions

- Never use alcohol, solvents, waxes, benzene, thinners, air freshener, or lubricants to clean the product or spray insecticide on the product.
  - Using any of these materials can discolor the exterior coating or cause it to split or peel off, or remove the labelling on the product.
- To clean the product, unplug the power cord, and then wipe the product with a clean, dry, soft cloth (Microfiber, cotton).
  - Avoid leaving dust on the product. Dust can scratch its the surface.

### Battery Usage Precautions

- Do not subject the product to high temperatures or fire. Do not bring the product into hot, poorly ventilated areas such as saunas or closed vehicles during the summer time.
  - There is a risk of fire or the battery could explode.
- Do not expose the product to high humidity.
  - Humidity and liquids can damage the components and electrical circuits of the product, cause the product to malfunction, and may cause a risk of fire. We recommended that you use the product in environments with temperatures between 41° and 95° F (5° ~ 35 °C) and relative humidities between 10% ~ 75%.
- Do not leave the product connected to the AC adaptor after the battery has been fully charged.
  - Disconnect the AC adapter after the battery is fully charged to prevent damage to the battery. Overcharging can decrease the battery's useful life.
- Check the charge status of the battery once a month. If you do not use the product for long periods of time, recharge the battery periodically to maintain battery capacity and functionality.
  - Leaving the battery discharged for a long time can reduce its useful life, cause the battery to malfunction, or cause a risk of fire.



## QUESTIONS OR COMMENTS?

### COUNTRY IN THE US

### CALL

1-800-SAMSUNG (726-7864)

### OR VISIT US ONLINE AT

[www.samsung.com](http://www.samsung.com)

### WRITE

Samsung Electronics America, Inc. 85 Challenger Road  
Ridgefield Park, NJ 07660



AH68-02622A-00

## LIMITED WARRANTY TO ORIGINAL PURCHASER

This SAMSUNG brand product, as supplied and distributed by Samsung Electronics America, Inc. (SAMSUNG) and delivered new, in the original carton to the original consumer purchaser, is warranted by SAMSUNG against manufacturing defects in materials and workmanship for a limited warranty period of:

### One (1) Year Parts and Labor\* (\*90 Days Parts and Labor for Commercial Use)

This limited warranty begins on the original date of purchase, and is valid only on products purchased and used in the United States. To receive warranty service, the purchaser must contact SAMSUNG for problem determination and service procedures. Warranty service can only be performed by a SAMSUNG authorized service center. The original dated bill of sale must be presented upon request as proof of purchase to SAMSUNG or SAMSUNG's authorized service center. Transportation of the product to and from the service center is the responsibility of the purchaser.

SAMSUNG will repair or replace this product, at our option and at no charge as stipulated herein, with new or reconditioned parts or products if found to be defective during the limited warranty period specified above. All replaced parts and products become the property of SAMSUNG and must be returned to SAMSUNG. Replacement parts and products assume the remaining original warranty, or ninety (90) days, whichever is longer.

SAMSUNG's obligations with respect to software products distributed by SAMSUNG under the SAMSUNG brand name are set forth in the applicable end user license agreement. Non-SAMSUNG hardware and software products, if provided, are on an "AS IS" basis. Non-SAMSUNG manufacturers, suppliers, publishers, and service providers may provide their own warranties.

This limited warranty covers manufacturing defects in materials and workmanship encountered in normal, and except to the extent otherwise expressly provided for in this statement, noncommercial use of this product, and shall not apply to the following, including, but not limited to: damage which occurs in shipment; delivery and installation; applications and uses for which this product was not intended; altered product or serial numbers; cosmetic damage or exterior finish; accidents, abuse, neglect, fire, water, lightning or other acts of nature; use of products, equipment, systems, utilities, services, parts, supplies, accessories, applications, installations, repairs, external wiring or connectors not supplied and authorized by SAMSUNG, or which damage this product or result in service problems; incorrect electrical line voltage, fluctuations and surges; customer adjustments and failure to follow operating instructions, cleaning, maintenance and environmental instructions that are covered and prescribed in the instruction book; product removal or reinstallation; reception problems and distortion related to noise, echo, interference or other signal transmission and delivery problems. SAMSUNG does not warrant uninterrupted or error-free operation of the product.

THERE ARE NO EXPRESS WARRANTIES OTHER THAN THOSE LISTED AND DESCRIBED ABOVE, AND NO WARRANTIES WHETHER EXPRESS OR IMPLIED, INCLUDING, BUT NOT LIMITED TO, ANY IMPLIED WARRANTIES OF MERCHANTABILITY OR FITNESS FOR A PARTICULAR PURPOSE, SHALL APPLY AFTER THE EXPRESS WARRANTY PERIODS STATED ABOVE, AND NO OTHER EXPRESS WARRANTY OR GUARANTY GIVEN BY ANY PERSON, FIRM OR CORPORATION WITH RESPECT TO THIS PRODUCT SHALL BE BINDING ON SAMSUNG. SAMSUNG SHALL NOT BE LIABLE FOR LOSS OF REVENUE OR PROFITS, FAILURE TO REALIZE SAVINGS OR OTHER BENEFITS, OR ANY OTHER SPECIAL, INCIDENTAL OR CONSEQUENTIAL DAMAGES CAUSED BY THE USE, MISUSE OR INABILITY TO USE THIS PRODUCT, REGARDLESS OF THE LEGAL THEORY ON WHICH THE CLAIM IS BASED, AND EVEN IF SAMSUNG HAS BEEN ADVISED OF THE POSSIBILITY OF SUCH DAMAGES. NOR SHALL RECOVERY OF ANY KIND AGAINST SAMSUNG BE GREATER IN AMOUNT THAN THE PURCHASE PRICE OF THE PRODUCT SOLD BY SAMSUNG AND CAUSING THE ALLEGED DAMAGE. WITHOUT LIMITING THE FOREGOING, PURCHASER ASSUMES ALL RISK AND LIABILITY FOR LOSS, DAMAGE OR INJURY TO PURCHASER AND PURCHASER'S PROPERTY AND TO OTHERS AND THEIR PROPERTY ARISING OUT OF THE USE, MISUSE OR INABILITY TO USE THIS PRODUCT SOLD BY SAMSUNG NOT CAUSED DIRECTLY BY THE NEGLIGENCE OF SAMSUNG. THIS LIMITED WARRANTY SHALL NOT EXTEND TO ANYONE OTHER THAN THE ORIGINAL PURCHASER OF THIS PRODUCT, IS NONTRANSFERABLE AND STATES YOUR EXCLUSIVE REMEDY.

Some states do not allow limitations on how long an implied warranty lasts, or the exclusion or limitation of incidental or consequential damages, so the above limitations or exclusions may not apply to you. This warranty gives you specific legal rights, and you may also have other rights which vary from state to state. To obtain warranty hardware service, please contact SAMSUNG customer care center.



## Free Manuals Download Website

<http://myh66.com>

<http://usermanuals.us>

<http://www.somanuals.com>

<http://www.4manuals.cc>

<http://www.manual-lib.com>

<http://www.404manual.com>

<http://www.luxmanual.com>

<http://aubethermostatmanual.com>

Golf course search by state

<http://golfingnear.com>

Email search by domain

<http://emailbydomain.com>

Auto manuals search

<http://auto.somanuals.com>

TV manuals search

<http://tv.somanuals.com>