

# SKM 5200-II



Instruction manual

 **SENNHEISER**

# Contents

Important safety instructions .....	2
The SKM 5200-II radio microphone .....	4
Delivery includes .....	6
Product overview .....	7
Overview of the SKM 5200-II radio microphone .....	7
Putting the radio microphone into operation .....	9
Inserting, removing and changing the power pack .....	9
Changing the microphone head .....	11
Using the radio microphone .....	13
Switching the radio microphone on/off .....	13
Doing a frequency check .....	14
The automatic lock mode (autolock function) .....	14
Identifying the radio microphone .....	15
The operating menu .....	16
The buttons .....	16
Overview of the operating menu .....	17
Working with the operating menu .....	17
Overview of the operating menu .....	21
Adjustment tips for the operating menu .....	23
Selecting a channel – “CHAN” .....	23
Selecting the frequencies to be stored in the channel bank “VAR” – “TUNE” .....	23
Entering a name – “NAME” .....	25
Adjusting the microphone sensitivity – “ATTEN” .....	26
Adjusting the low-cut frequency – “LOWCUT” .....	26
Selecting the standard display – “VIEW” .....	26
Loading the factory-preset default settings – “RESET” .....	27
Activating/deactivating the automatic lock mode – “LOCK” .....	27
Adjusting the output power – “POWER” .....	28
Displaying the software revision – “SW--REV” .....	28
Exiting the operating menu – “EXIT” .....	28
Maintenance and care .....	28
If a problem occurs ... ..	29
Accessories .....	30
Specifications .....	31
Manufacturer Declarations .....	34















# Important safety instructions

- Read this instruction manual.
- Keep this instruction manual. Always include this instruction manual when passing the product on to third parties.
- Heed all warnings and follow all instructions in this instruction manual.
- Use only a cloth for cleaning the product.
- Do not place the product near any heat sources such as radiators, stoves, or other devices (including amplifiers) that produce heat.
- Only use attachments/accessories specified by Sennheiser.
- Refer all servicing to qualified service personnel.  
Servicing is required if the product has been damaged in any way, liquid has been spilled, objects have fallen inside, the product has been exposed to rain or moisture, does not operate properly or has been dropped.
- **WARNING:** To reduce the risk of short circuits, do not use the product near water and do not expose it to rain or moisture.

## Safety instructions for handling rechargeable batteries

When used properly, rechargeable batteries are a safe and reliable energy source. However, if abused or misused, rechargeable batteries may leak and, in extreme cases, may even present an explosion and fire hazard.

Please understand that Sennheiser does not accept liability for damage arising from abuse or misuse. Especially observe the following safety instructions.

	Keep away from children.		Only use rechargeable batteries recommended by Sennheiser.
	Observe correct polarity.		Do not short-circuit.
	Do not expose to moisture.		Switch rechargeable battery-powered products off after use.
	Do not get fully charged but unpacked rechargeable batteries mixed up.		When not using rechargeable batteries for extended periods of time, charge them regularly (about every three months).
	Only charge rechargeable batteries at ambient temperatures between 10°C/50°F and 40°C/104°F.		Do not heat above 70°C/158°F, e.g. do not expose to sunlight or throw into a fire.
	Do not mutilate or dismantle.		Do not continue to use defective rechargeable batteries.
	Immediately remove rechargeable batteries from obviously defective units.		Dispose of rechargeable batteries at special collection points or return them to your specialist dealer.
	Only charge rechargeable batteries with the appropriate Sennheiser chargers.		

### Intended use of the radio microphone

Intended use of the product includes:

- having read this instruction manual especially the chapter "Important safety instructions",
- using the product within the operating conditions and limitations described in this instruction manual.

"Improper use" means using the product other than as described in this instruction manual, or under operating conditions which differ from those described herein.

# The SKM 5200-II radio microphone

The SKM 5200-II is a professional hand-held radio microphone transmitter that is easy to use and is easily adaptable to a wide variety of applications:

- Suitable for all-purpose use, e.g. for reporting, stage and studio applications.
- Rugged housing and intuitive, menu-assisted operation.
- Screw-on microphone heads with different pick-up patterns (omni-directional, cardioid and super-cardioid) for a wide variety of applications. A super-cardioid dynamic microphone head capable of accommodating extremely high sound pressure levels is also available.
- Microphone sensitivity can be adjusted in steps of 1 dB.
- Tunable transmission frequencies ensure high flexibility in varying transmission situations.
- Can be operated either on rechargeable or standard alkaline batteries – with LC display (in percent) of charging status on suitable receivers.
- Color-coded identification markers for quick and unambiguous identification.
- Switchable low-cut filter
- Up to 184 MHz switching bandwidth
- Signal-to-noise ratio typ. 110 dB(A)
- Adjustable output power:  
10 mW, 10 mW Low Intermodulation mode (LoI), 50 mW.  
In Low Intermodulation mode (LoI), the intermodulation performance is significantly improved.

## Information on the compander system

This product is equipped with HiDy*nplus*<sup>™</sup>, the Sennheiser noise reduction system that reduces RF interference. HiDy*nplus*<sup>™</sup> offers extreme operational reliability and ensures highest transmission quality.

## The channel bank system

The transmitter is available in five UHF frequency ranges with up to 184 MHz switching bandwidth:

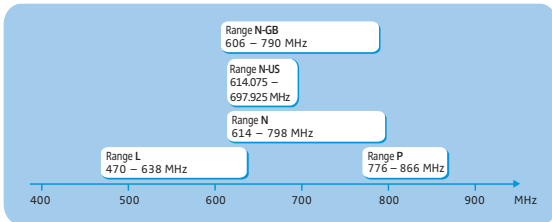

The transmitter has two frequency banks:

Channel	Frequency bank	
	"FIX"	"VAR"
1	The transmission frequencies are factory-preset (see enclosed frequency table) and cannot be changed.	The transmission frequencies can be freely selected within the switching bandwidth.
2		
...		
max. 59		
	<p>Optimized for maximum transmission reliability</p> <p>Additionally available channels in Low Inter-modulation mode</p>	



The factory-preset frequencies within the frequency bank "FIX" are interference and intermodulation-free.

- ▶ Set all transmitters of your multi-channel system to different channels within the frequency bank "FIX".

### Variants

- SKM 5200-II (hematite-colored housing)
- SKM 5200 BK-II (black housing)
- SKM 5200 NI-II (nickel-colored housing)

### Suitable receivers

- EM 1046 system
- EM 3532, EM 3031, EM 3032
- EK 3041, EK 3241
- EM 3731, EM 3732, EM 3732 COM
- EM 3731-II, EM 3732-II, EM 3732 COM-II

## Delivery includes

- 1 radio microphone transmitter body SKM 5200-II  
(microphone head and power pack to be ordered separately)
- 1 MZQ 3072 quick release clamp
- 9 color-coded identification markers
- 1 instruction manual
- 1 frequency table
- 1 supplement "Legal requirements for the use of radiomicrophones"

# Product overview

## Overview of the SKM 5200-II radio microphone

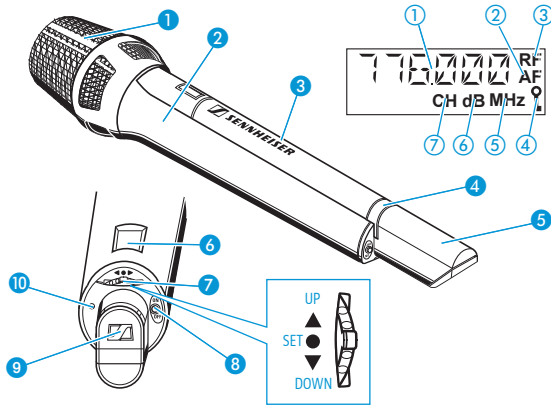

### Operating controls

- ① Screw-on microphone head (not included in the delivery)
- ② Body of radio microphone
- ③ Power pack (not included in the delivery)
- ④ Battery compartment locking mechanism
- ⑤ Antenna
- ⑥ LC display
- ⑦ Multi-function switch with three switch positions:  
▼ (DOWN), ▲ (UP) and • (SET)
- ⑧ ON/OFF button (red) with ESC function (cancel)
- ⑨ Color-coded identification marker
- ⑩ LED ON/LOW BATT: operation and battery status indication, green LED

### LC display panel

- ① Alphanumeric display
- ② Level display for audio signal "AF"
- ③ "RF" – appears when an RF signal is transmitted
- ④ Lock mode icon
- ⑤ "MHz" – appears when the frequency is displayed
- ⑥ "dB" – appears when the microphone sensitivity is displayed
- ⑦ "CH" – appears when the channel number is displayed



## Display backlighting

When the lock mode is deactivated, the display remains backlit for approx. 20 seconds after pressing a button.

## Operation and battery status indication

The LED ON/LOW BATT 10 provides information on the current operating state of the radio microphone:

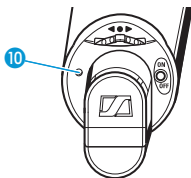

LED ON/LOW BATT 10 ...	Meaning
... lights up normally	The radio microphone is switched on and the capacity of the power pack is sufficient (ON).
... is flashing	The power pack is going flat (LOW BATT)!

# Putting the radio microphone into operation

## Inserting, removing and changing the power pack

For powering the radio microphone, you can either use the Sennheiser B 5000-2 battery box (1.5 V AA size batteries) or the rechargeable Sennheiser BA 5000-2 battery pack. For regular use, we recommend using the environmentally friendly rechargeable BA 5000-2 battery pack.



For battery pack operation of the radio microphone, only use the BA 5000-2 battery pack in order to ensure optimum operational reliability. Batteries and rechargeable battery cells have different discharging curves. The radio microphone is able to identify the BA 5000-2 battery pack and to use its capacity to the full. Individual rechargeable battery cells in the B 5000-2 battery box will not be identified as battery packs.

### Inserting the power pack

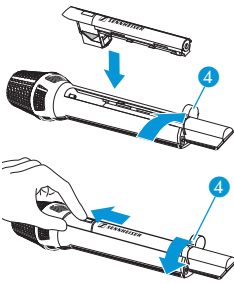

- ▶ Open the locking mechanism 4 by moving it in the direction of the arrow.
- ▶ Insert the power pack into the radio microphone.
- ▶ Push the power pack towards the microphone head.
- ▶ Close the locking mechanism 4 by moving it in the direction of the arrow.

### Removing the power pack

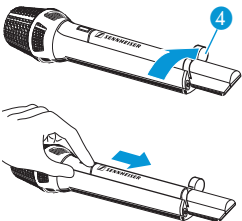

- ▶ Open the locking mechanism 4 by moving it in the direction of the arrow.
- ▶ Push the power pack towards the antenna.  
You can now remove the power pack.



After you have changed the power pack, the radio microphone continues operating on exactly the same settings as before the change. Stored settings are retained in memory on switch-off.

### Inserting batteries into the B 5000-2 battery box

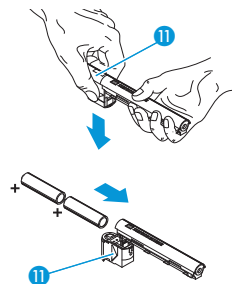

- ▶ To open the battery box, push down the display section 11 of the battery box 3.
- ▶ Insert the batteries. Observe correct polarity when inserting the batteries.
- ▶ Close the battery box.

### LC display shown on the example of the B 5000-2 battery box

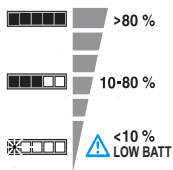

- 3-step LC display for remaining battery capacity.
- If the battery capacity is too low (LOW BATT), the last segment starts flashing and the batteries must be changed.

### Recharging the BA 5000-2 battery pack

Before using the BA 5000-2 battery pack (see "Accessories" on page 30) for the first time or if you have not used it for several weeks, you must charge the battery pack completely.

The L 50 charger (see "Accessories" on page 30) can charge two BA 5000-2 battery packs simultaneously.

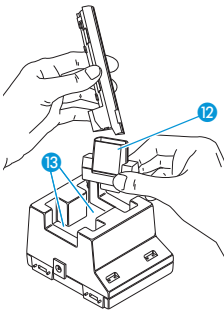

- ▶ Place the appropriate charging adapter 12 in the charging compartment 13 of the charger.
- ▶ Insert the BA 5000-2 battery pack into the charging adapter 12.  
Charging time: approx. 2.5 hrs with the L 50 charger (dependent on the residual charge of the battery pack).



The battery pack is carefully charged using the  $-\Delta U$ -method. For further details, please refer to the user manual of the L 50 charger.

### LC display shown on the example of the BA 5000-2 battery pack

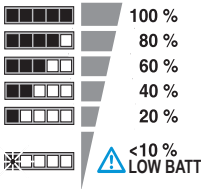

- 6-step LC display for (remaining) battery pack capacity.
- Microprocessor-controlled electronics takes self-discharge of rechargeable cells into account.
- The maximum capacity of is reduced due to natural ageing of the cells. The BA 5000-2 battery pack measures the maximum capacity and therefore displays less than 100% capacity for older cells – even when they have been fully charged.

## Changing the microphone head

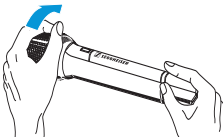

- ▶ Unscrew the microphone head by turning it in the direction of the arrow.

## Putting the radio microphone into operation

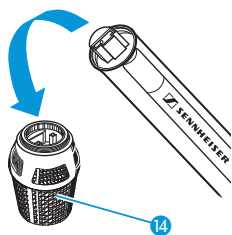

- ▶ Pull off the microphone head 14.
- ▶ Put on the new microphone head.
- ▶ Screw tight the microphone head by turning it against the direction indicated by the arrow.

Different microphone heads ensure suitability for a wide variety of applications:

Model	Type	Pick-up pattern	SPL
ME 5002	condenser	omni	138 dB
ME 5004	condenser	cardioid	139 dB
ME 5005	condenser, high feedback rejection	super-cardioid	154 dB
ME 5005e	condenser, high feedback rejection	super-cardioid	158 dB
ME 5009	condenser	wide cardioid	140 dB
MD 5235	dynamic, high feedback rejection	cardioid	163 dB
KK 105 S (nickel-colored)	condenser (Neumann)	super-cardioid	155 dB
KK 105 BK (black)	condenser (Neumann)	super-cardioid	155 dB
KK 104 S (nickel-colored)	condenser (Neumann)	cardioid	153 dB
KK 104 BK (black)	condenser (Neumann)	cardioid	153 dB

# Using the radio microphone

## Switching the radio microphone on/off

To switch the radio microphone on:

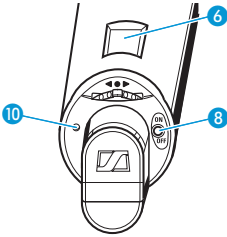

- ▶ Briefly press the ON/OFF button 8. The LED ON/LOW BATT 10 lights up and the standard display is shown on the display panel 6; after a short pause, "RF" appears on the display panel 6.



Remove the batteries or the battery pack when the radio microphone will not be used for extended periods of time.

The radio microphone can only be switched off when the lock mode is deactivated (see page 15).

To switch the radio microphone off:



- ▶ Press the ON/OFF button 8 until "OFF" appears on the display panel 6. The LED ON/LOW BATT 10 and the display on the display panel 6 go off.



When in the setting mode of the operating menu, the ON/OFF button 8 will cancel your entry (ESC function).

## Doing a frequency check

The radio microphone has a frequency check mode that prevents that the radio microphone transmits on an unwanted frequency after switch-on.

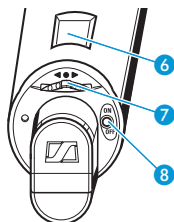

- ▶ When switching on the device, keep the **ON/OFF** button **8** depressed. The RF signal is deactivated. The current frequency is displayed on the LC display panel **6**.

If the displayed frequency is the wanted frequency:



- ▶ Release the **ON/OFF** button **8**. After five seconds the “**RF**” **3** icon appears and the radio microphone starts transmitting.

If you want to select another frequency, proceed as follows:

- ▶ Release the **ON/OFF** button **8**.
- ▶ Within 5 seconds, change to the setting mode of the “**CHAN**” or “**TUNE**” menu.
- ▶ Change the transmission frequency (see “Adjustment tips for the operating menu” on page 23).

## The automatic lock mode (autolock function)

The radio microphone has a lock mode that prevents that the radio microphone is accidentally programmed while operating. When the autolock function is activated via the “**LOCK**” menu (see page 27) the lock mode is automatically activated 10 seconds after pressing the last button and remains activated.



- Prior to this, the lock mode icon **4** flashes several times on the display.



You can deactivate the autolock function either permanently (see page 27) or temporarily (see page 15).

### Deactivating the autolock function temporarily

To be able to make changes to the settings via the operating menu, you must temporarily deactivate the lock mode.

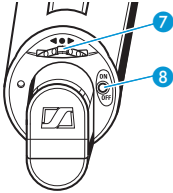

- ▶ To achieve this, either press the ON/OFF button 8 or the multi-function switch 7 (switch position • SET).



“LOCK” appears on the display panel.

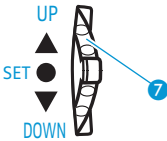

- ▶ Slide the multi-function switch 7 to the position ▲ (UP) or ▼ (DOWN). “UNLOCK” appears on the display panel.
- ▶ Press the multi-function switch 7 (switch position • SET).



You can now change the settings.

After you have exited the operating menu, the lock mode is automatically re-activated after 10 seconds. You can also immediately activate the lock mode by pressing the ON/OFF button 8 briefly.

### Identifying the radio microphone

The radio microphone comes with nine interchangeable color-coded identification markers, allowing you to clearly identify each radio microphone.

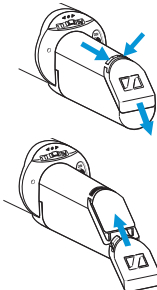

- ▶ To remove the identification marker, press the two snap-in pins together while sliding the identification marker out of the guide rails.
- ▶ Put on the new identification marker by sliding it onto the guide rails.



# The operating menu

## The buttons

Button	Mode	Function
ON/OFF, ESC	Switched off	<ul style="list-style-type: none"> <li>Briefly pressing the button: Switching the radio microphone on</li> <li>Keeping the button pressed: Doing a frequency check</li> </ul>
	Display mode	<ul style="list-style-type: none"> <li>Briefly pressing the button (with activated autolock function): Immediately activating the lock mode</li> <li>Briefly pressing the button (with activated lock mode): Calling up the lock mode for deactivation</li> <li>Pressing the button for 3 sec. (with deactivated lock mode): Switching the radio microphone off</li> </ul>
	Selection mode	Canceling the entry and returning to the display mode
	Setting mode	Canceling the entry and returning with the last setting stored to the last parameter displayed in the display mode
• SET	Display mode	<ul style="list-style-type: none"> <li>With deactivated lock mode: Changing to the selection mode</li> <li>With activated lock mode: Calling up the lock mode for deactivation</li> </ul>
	Selection mode	Changing to the setting mode of the selected menu
	Setting mode	Storing the setting and returning to the selection mode ("STORED" is displayed)

Button	Mode	Function
▲ (UP)/ ▼ (DOWN)	Display mode	Changing to the previous parameter (▲) or changing to the next parameter (▼)
▲ (UP)/ ▼ (DOWN)	Selection mode	Changing to the previous menu (▲) or changing to the next menu (▼)
	Setting mode	Increasing (▲) or reducing (▼) the setting of the selected menu

## Overview of the operating menu

Menu	Function of the menu
"CHAN"	Selects a channel
"TUNE"	Sets transmission frequencies for the frequency bank "VAR" (variable bank)
"NAME"	Enters a name
"ATTEN"	Adjusts the microphone sensitivity
"LOWCUT"	Adjusts the bass roll-off frequency
"VIEW"	Selects the standard display
"RESET"	Loads the factory-preset default settings
"LOCK"	Activates/deactivates the autolock function
"POWER"	Adjusts the output power
"SW--REV"	Displays the current software revision
"EXIT"	Exits the operating menu and returns to the standard display

## Working with the operating menu

The operating menu has three modes:

- Display mode  
In display mode, you can display the current menu settings one after the other – even when the lock mode is activated.
- Selection mode  
In selection mode, you can select the menu whose setting you want to change. To change to the selection mode, the lock mode must be deactivated.
- Setting mode  
In setting mode, you can change the setting of the selected menu.

By way of example of the “LOWCUT” menu, this section describes how to use the operating

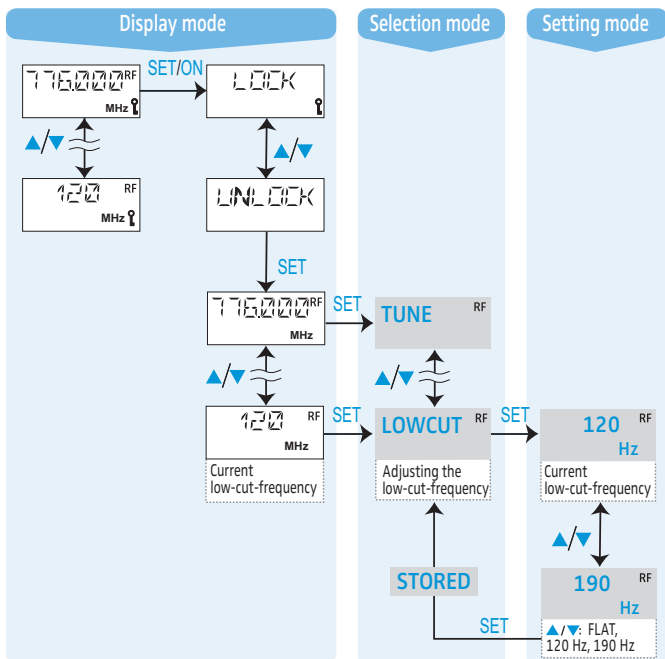

### After switch-on

After switch-on, the standard display is shown on the display panel. Depending on the setting, the transmission frequency, the channel number or the name of the radio microphone is displayed.

### Displaying the menu settings in display mode

In display mode, and with the lock mode activated, you can display the current menu settings one after the other (see “Overview of the operating menu” on page 21). After a few seconds, the display returns to the standard display. With the lock mode activated, the LC display is not backlit.

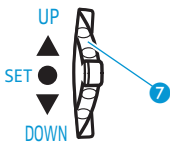

- ▶ Slide the multi-function switch 7 to the position ▲ (UP) or ▼ (DOWN) to display the menu settings. If you slide the multi-function switch repeatedly to the same position, all menu settings are displayed one after the other.

### Changing to the selection mode

To change from display mode to selection mode, you have to deactivate the lock mode.

- ▶ Deactivate the lock mode (see “Deactivating the autolock function temporarily” on page 15). You can now select the menu whose settings you want to adjust.
- ▶ Press the multi-function switch 7 (switch position • SET) to change to the menu that was displayed in display mode.

### Selecting a menu

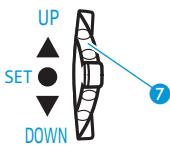

- ▶ Slide the multi-function switch 7 to the position ▲ (UP) or ▼ (DOWN).
- ▶ Press the multi-function switch 7 (switch position • SET). The name of the selected menu starts flashing.

### Changing to the setting mode of a selected menu

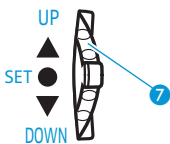

- ▶ Press the multi-function switch 7 (switch position • SET) to change to the setting mode of the selected menu. The current setting that can be adjusted flashes on the display.

### Adjusting a setting

- ▶ Use the multi-function switch 7 to adjust the setting of the selected menu.

By briefly sliding the multi-function switch 7 to the position ▲ (UP) or ▼ (DOWN), the display jumps either forwards or backwards to the next setting.

In the "ATTEN", "CHAN", "TUNE" and "NAME" menu and when slid to the position ▲ (UP) or ▼ (DOWN), the multi-function switch features a "fast search" function, i.e. the display cycles continuously. In the "TUNE" menu, the cycling of the display is continuously accelerated. The "fast search" function allows you to get fast and easily to your desired setting.

### Storing a setting

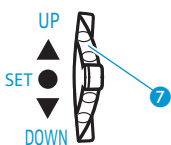

- ▶ Press the multi-function switch 7 (switch position ● SET) to permanently store a setting. "STORED" appears on the display panel, indicating that the setting has been stored. The display then returns to the top menu level.

With most menus, new settings become effective immediately without having to be stored. An exception are the "TUNE" and "CHAN" menus. With these menus, new settings only become effective after they have been stored ("STORED" appears on the display panel, indicating that the setting has been stored).

### Exiting the operating menu

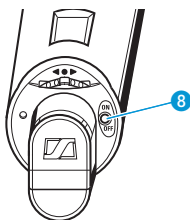

- ▶ Select the "EXIT" menu to exit the operating menu and to return to the standard display.

When in the operating menu, pressing the ON/OFF button 8 will cancel your entry (ESC function) and return you to the standard display with the last stored settings.

## Overview of the operating menu

Deactivate the lock mode before adjusting the settings (see “Deactivating the autolock function temporarily” on page 15). Pressing the **ON/OFF** button **8** will cancel your entry (ESC function) and return you to the display mode.

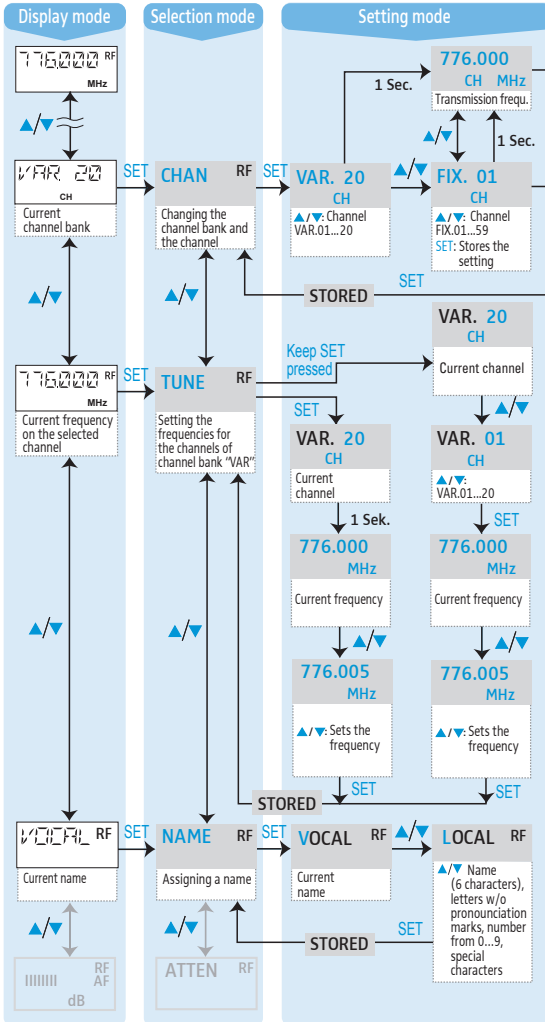

# The operating menu

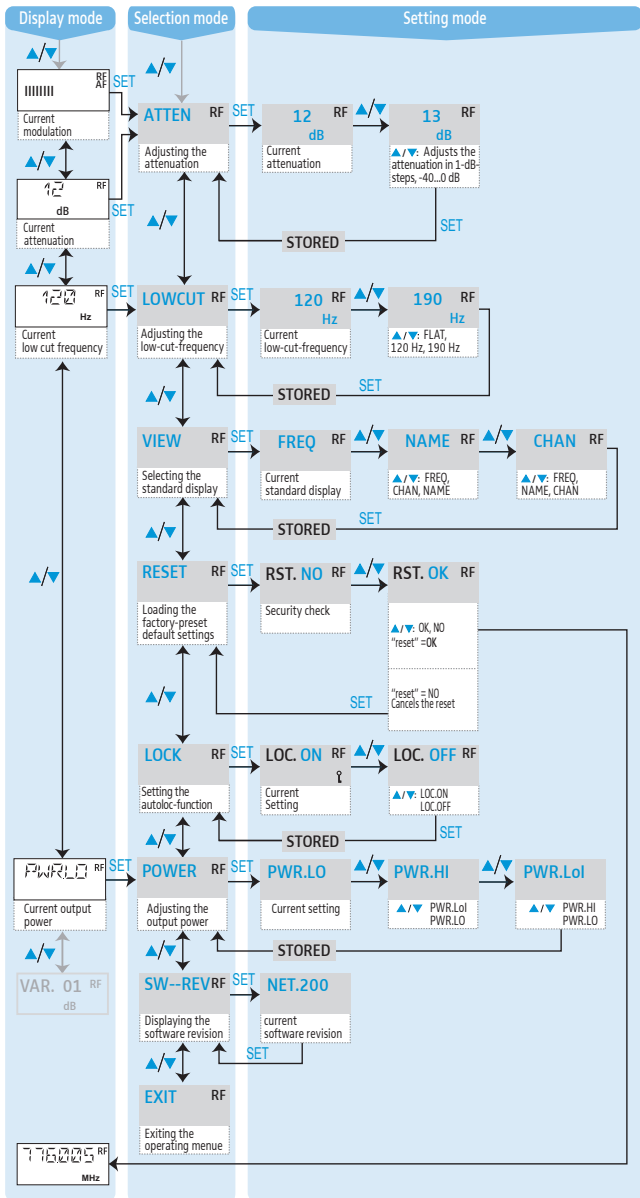

# Adjustment tips for the operating menu



When setting frequencies on the radio microphone, please observe the following:

- ▶ Make sure that the desired frequencies are listed in the enclosed frequency table and approved and legal in your country. If necessary, apply for an operating license. For an overview of the frequencies and transmission powers, refer to the enclosed supplement "Legal requirements for the use of radiomicrophones".

## Selecting a channel – "CHAN"

Via the "CHAN" menu, you can switch between the channels in the channel banks "FIX" and "VAR". The radio microphone is not transmitting while this adjustment is being made.

When changing to the setting mode of the "CHAN" menu, the current channel number appears on the display. After approx. 1 second, the currently assigned frequency is displayed.

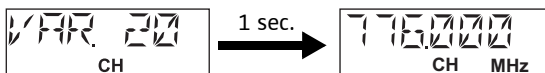

- ▶ To select a different channel, slide the multi-function switch 7 to the position ▲ (UP) or ▼ (DOWN). The new channel number appears on the display panel for approx. 1 second and then the currently assigned frequency is displayed.

Only after the new setting has been stored ("STORED" has appeared on the display panel) does the transmitter operate on the transmission frequency of the new channel.

## Selecting the frequencies to be stored in the channel bank "VAR" – "TUNE"

Via the "TUNE" menu, you can freely select the frequencies to be stored in the channel bank "VAR" (variable bank). The radio microphone is not transmitting while this adjustment is being made.





When you have selected the channel bank "FIX" and then select the "TUNE" menu, the radio microphone automatically switches to channel 01 of the channel bank "VAR" and "VAR" briefly appears on the display panel 6.

The transmission frequencies are tunable in 5-kHz steps within a switching bandwidth of 184 MHz max.



When operating a multi-channel system, make sure to only use intermodulation-free frequencies.

There are two options for setting the frequencies:

- You can set a new frequency for the selected channel:

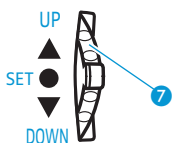

- In the selection mode of the "TUNE" menu, press the multi-function switch 7 (switch position • SET). The current channel number appears on the display and then the currently assigned frequency is displayed.

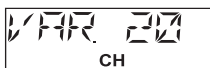

- Change the frequency by sliding the multi-function switch 7 to the position ▲ (UP) or ▼ (DOWN).
- Store your setting.

- You can change to a different channel and set a new frequency for the new channel:

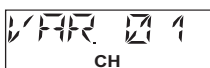
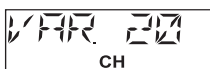
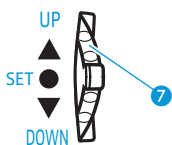

- Press the multi-function switch for a longer time 7 (switch position • SET). The current channel flashes on the display.
- Select a new channel by sliding the multi-function switch 7 to the position ▲ (UP) or ▼ (DOWN).
- Confirm your selection by pressing the multi-function switch 7 (switch position • SET).

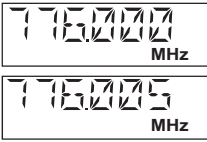

- ▶ The current frequency of the selected channel is displayed. Change the frequency by sliding the multi-function switch 7 to the position ▲ (UP) or ▼ (DOWN).
- ▶ Store your setting.

## Entering a name – “NAME”

Via the “NAME” menu, you can enter a freely selectable name for the radio microphone. This name can be displayed on the standard display and can consist of up to six characters such as:

- letters (without pronunciation marks),
- numbers from 0 to 9,
- special characters and spaces.

After you have changed to the setting mode of the “NAME” menu, the first segment starts flashing on the display.

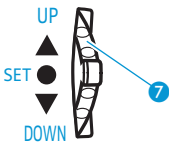

- ▶ Slide the multi-function switch 7 to the position ▲ (UP) or ▼ (DOWN) to select a character.  
(By sliding the switch only once, the next or the previous character is displayed. If you keep the switch slid, the characters change in quick succession.)
- ▶ Press the multi-function switch 7 (switch position • SET) to change to the next segment.
- ▶ Have you entered the name completely? Press the multi-function switch 7 (switch position • SET) to store your setting. “STORED” appears on the display panel 6.

## Adjusting the microphone sensitivity – “ATTEN”

Via the “ATTEN” menu, you can adjust the radio microphone’s sensitivity by changing its input attenuation.

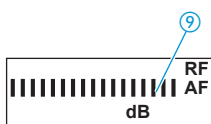

The input attenuation is correctly adjusted when the level display for audio signal “AF” shows full deflection ⑨ only during the loudest passages. The input attenuation can be adjusted in 1-dB steps from –40 dB to 0 dB.



The bargraph has a resolution of approx. 3 dB per segment with a display range of 45 dB.

## Adjusting the low-cut frequency – “LOWCUT”

To reduce unwanted low-frequency noise such as engine, wind and rumble noise, you can activate a low-cut filter. The low-cut frequency can be set to 190 Hz or 120 Hz.

If you do not want to reduce low-frequency signal portions, select the setting “FLAT”.

## Selecting the standard display – “VIEW”

Via the “VIEW” menu, you can select one of the following standard displays:

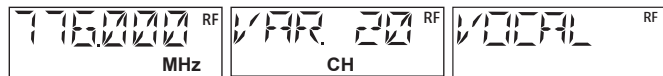

Transmission  
frequency “FREQ”

Channel “CHAN”

Name “NAME”

The selected standard display is shown

- after switch-on,
- after the menu settings have been displayed in display mode.

## Loading the factory-preset default settings – “RESET”

Via the “RESET” menu, you can load the factory-preset default settings. After the reset, the standard display is shown on the display panel.

Function	Setting
Low-cut frequency	“FLAT”
Microphone sensitivity	“-20 dB”
Name	“5200”
Standard display	frequency
Autolock function	deactivated
Channel	“FIX 01”
Output power	“PWR.HI”
Frequencies in the channel bank “VAR” are reset	

## Activating/deactivating the automatic lock mode – “LOCK”

The radio microphone has an autolock function (automatic lock mode) that can be activated or deactivated via the “LOCK” menu. When the autolock function is activated, the lock mode is automatically activated 10 seconds after pressing the last button. The lock mode protects the radio microphone from accidental programming. For daily use, we would recommend activating the autolock function.

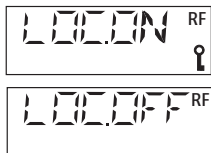
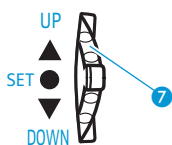

- ▶ In the selection mode of the “Lock” menu, press the multi-function switch 7 (switch position • SET). The current setting of the autolock function is displayed.
- ▶ Change the setting by sliding the multi-function switch 7 to the position ▲ (UP) or ▼ (DOWN). Select “LOC.ON” to activate the autolock function or select “LOC.OFF” to deactivate the autolock function.
- ▶ Store your setting.

## Adjusting the output power – “POWER”

The radio microphone features switchable output power. With reduced output power, the operating time increases.

In addition, you can also adjust the radio microphone to “Low Intermodulation mode” (“LoI”). By so doing, the radio microphone’s intermodulation performance is significantly improved, especially in multi-channel operation. In “Low Intermodulation mode”, the output power is reduced to 10 mW; the operating time will be about the same as using an output power of 50 mW.

## Displaying the software revision – “SW--REV”

You can display the current software revision of the radio microphone by calling up the “SW--REV” menu item.

## Exiting the operating menu – “EXIT”

Via the “EXIT” menu, you can exit the operating menu and return to the standard display.

When in the operating menu, briefly pressing the ON/OFF button **8** will cancel your entry (ESC function) and return you to the standard display without saving any changes.

# Maintenance and care

---

**CAUTION!** Liquids can damage the electronics of the radio microphone!

Liquids entering the housing of the device can cause a short-circuit and damage the electronics.

▶ Keep all liquids away from the radio microphone.

---

- ▶ Use a cloth to clean the radio microphone from time to time.
- ▶ Do not use any solvents or cleansing agents.

## If a problem occurs ...

Problem	Possible cause	Possible solution
No operation indication	Batteries are flat or inserted incorrectly, battery pack is flat	Replace the batteries or check if they are inserted correctly or recharge the battery pack
Transmitter cannot be switched off/ Settings cannot be changed	Lock mode is activated	Deactivate the lock mode (see "Deactivating the autolock function temporarily" on page 15)
Receiver: No RF signal	Transmitter and receiver are not on the same channel	Set transmitter and receiver to the same channel
	Transmitter is out of range	Check the squelch threshold setting or reduce the distance between receiving antenna and transmitter
Weak signal	Antenna signal is attenuated	Do not clasp the antenna section
Audio signal has a high level of background noise	Transmitter's input attenuation is adjusted too high	see "Adjusting the microphone sensitivity – "ATTEN"" on page 26
	Receiver's output level is adjusted too low	Increase the line output level
Audio signal is distorted	Transmitter's input attenuation is adjusted too low	see "Adjusting the microphone sensitivity – "ATTEN"" on page 26
	Receiver's output level is adjusted too high	Reduce the line output level

If a problem occurs that is not listed in the above table or if the problem cannot be solved with the proposed solutions, please contact your local Sennheiser partner for assistance. To find a Sennheiser partner in your country, search at [www.sennheiser.com](http://www.sennheiser.com) under "Service & Support".

## Accessories

- 003763 ME 5009 microphone head
- 003760 ME 5005 microphone head
- 005249 ME 5005e microphone head
- 003762 ME 5004 microphone head
- 003761 ME 5002 microphone head
- 500822 MD 5235 microphone head
- 008474 Neumann KK 105 S microphone head
- 008476 Neumann KK 105 S-BK microphone head
- 008533 Neumann KK 104 S-BK microphone head
- 008534 Neumann KK 104 S microphone head
- 005273 B 5000-2 battery box
- 005274 BA 5000-2 battery pack  
incl. charging adapter for the L 50 charger
- 003554 L 50 charger (for BA 5000-2 battery pack)
- 051662 Charging adapter for L 50 charger
- 003824 MZW 5000-ANT windshield,  
anthracite, without identification ring
- 003825 MZW 5000-BL windshield  
with blue identification ring
- 003826 MZW 5000-GE windshield  
with yellow identification ring
- 003827 MZW 5000-GN windshield  
with green identification ring
- 003828 MZW 5000-RT windshield  
with red identification ring
- 003829 MZW 5000-WS windshield  
with white identification ring
- 512888 9 color-coded identification markers

# Specifications

Modulation	wideband FM
Frequency range	range L: 470 to 638 MHz range N: 614 to 798 MHz range N-US: 614.075 to 697.925 MHz range N-GB: 606 to 790 MHz range P: 776 to 866 MHz
Switching bandwidth	up to 184 MHz
Transmission frequencies	frequency bank "FIX" with up to 59 factory-preset frequencies frequency bank "VAR" with 20 freely selectable frequencies (frequencies tuneable in steps of 5 kHz)
RF output power	switchable, typ.: 50 mW (PWR.Hi) 10 mW (PWR.LO) 10 mW (PWR.LoI)
Frequency stability	$\pm 10$ kHz within the specified temperature range
Nominal/peak deviation	$\pm 40$ kHz/ $\pm 56$ kHz
Signal-to-noise ratio	typ. 110 dB (A) <sub>rms</sub>
THD (at 1 kHz, nom. deviation)	< 0.5%
AF frequency response	60–20,000 Hz
Noise reductions system	Sennheiser HiDyn <i>plus</i> <sup>TM</sup>
Low-cut frequency (–3 dB)	adjustable (flat, 120 Hz, 190 Hz)
Sensitivity	adjustable in steps of 1 dB from –40 to 0 dB



## Specifications

Power consumption  
(without LC display illumination)

---

PWR.LO: approx. 140 mA  
(10 mW) at 2.4 V  
PWR.HI: approx. 195 mA  
(50 mW) at 2.4 V  
PWR.Lol: approx. 195 mA  
(10 mW) at 2.4 V

---

Operating time

---

with B 5000-2:  
PWR.LO: approx. 13 hrs  
PWR.HI: approx. 7 hrs 30 min  
PWR.Lol: approx. 7 hrs 30 min

---

with BA 5000-2:  
PWR.LO: approx. 12 hrs 40 min  
PWR.HI: approx. 7 hrs 20 min  
PWR.Lol: approx. 7 hrs 20 min

---

Dimensions

---

length: 200 mm  
(without microphone head),  
Ø 35.5 mm

---

Weight

---

approx. 300 g incl. BA 5000-2,  
without microphone head

---

### Operating conditions

Ambient temperature

---

-10 °C to +55 °C

---

Relative humidity

---

max. 90 %  
(non condensing)

---

Power supply

---

B 5000-2 battery box (1.5 V AA  
size batteries) or  
rechargeable Sennheiser  
BA 5000-2 battery pack

---

### Storage and transport conditions

Ambient temperature

---

-25°C to +70°C

---

Relative humidity

---

max. 90%

---

Shock test

---

shock test according to  
IEC 68 or EN 60068, T2-27

---

**In compliance with**

Europe



---

EMC	EN 301489-1/-9
Radio	EN 300422-1/-2
Safety	EN 60065
	EN 62311 (SAR)

---

**Approved by**

Canada

---

Industry Canada RSS-123  
IC: 2099A-SKM5200A2  
limited to 698 MHz

---

USA

---

FCC-Part 74  
FCC ID: DMOSKM5200A2  
limited to 698 MHz

---

# Manufacturer Declarations

## Warranty

Sennheiser electronic GmbH & Co. KG gives a warranty of 24 months on this product.

For the current warranty conditions, please visit our website at [www.sennheiser.com](http://www.sennheiser.com) or contact your Sennheiser partner.

## In compliance with

- RoHS Directive (2002/95/EC)
- Battery Directive (2006/66/EC)

The supplied batteries or rechargeable batteries can be recycled. Please dispose of them as special waste or return them to your specialist dealer. In order to protect the environment, only dispose of exhausted batteries.



## CE Declaration of Conformity

- **CE 0682** ⓘ
- R&TTE Directive (1999/5/EC)

The declarations are available at [www.sennheiser.com](http://www.sennheiser.com).

Before putting the device into operation, please observe the respective country-specific regulations.

## Statements regarding FCC and Industry Canada

This device complies with Part 15 of the FCC Rules and with RSS-123 of Industry Canada. Operation is subject to the following two conditions: (1) this device may not cause harmful interference, and (2) this device must accept any interference received, including interference that may cause undesired operation.

This equipment has been tested and found to comply with the limits for a Class B digital device, pursuant to Part 15 of the FCC Rules. These limits are designed to provide reasonable protection against harmful interference in a residential installation. This equipment generates, uses and can radiate radio frequency energy and, if not installed and used in accordance with the instructions, may cause harmful interference to radio communications. However, there is no guarantee that interference will not occur in a particular installation. If this equipment does cause harmful interference to radio or television reception, which can be determined by turning the equipment off and on, the user is encouraged to try to correct the interference by one or more of the following measures:

- Reorient or relocate the receiving antenna.
- Increase the separation between the equipment and receiver.
- Connect the equipment into an outlet on a circuit different from that to which the receiver is connected.
- Consult the dealer or an experienced radio/TV technician for help.

This class B digital device complies with the Canadian ICES-003.

Changes or modifications made to this equipment not expressly approved by Sennheiser electronic Corp. may void the FCC authorization to operate this equipment.

Before putting the device into operation, please observe the respective country-specific regulations!

**Sennheiser electronic GmbH & Co. KG**

Am Labor 1, 30900 Wedemark, Germany  
[www.sennheiser.com](http://www.sennheiser.com)

Printed in Germany, Publ. 11/10, 542645/A01



## Free Manuals Download Website

<http://myh66.com>

<http://usermanuals.us>

<http://www.somanuals.com>

<http://www.4manuals.cc>

<http://www.manual-lib.com>

<http://www.404manual.com>

<http://www.luxmanual.com>

<http://aubethermostatmanual.com>

Golf course search by state

<http://golfingnear.com>

Email search by domain

<http://emailbydomain.com>

Auto manuals search

<http://auto.somanuals.com>

TV manuals search

<http://tv.somanuals.com>