



SR 2000 IEM SR 2050 IEM

Contents

Important safety instructions	2
The SR 2000 IEM and SR 2050 IEM transmitters	4
The frequency bank system	4
Areas of application	5
Delivery includes	5
Product overview	6
Overview of the SR 2000 IEM/SR 2050 IEM transmitter	6
Overview of the displays	7
Putting the transmitter into operation	8
Setting up the transmitter on a flat surface	8
Mounting the transmitter into a 19" rack	8
Connecting the antennas	8
Connecting an audio source to the input sockets	11
Daisy chaining audio signals	11
Connecting devices to the output sockets	12
Connecting transmitters in a network	12
Connecting the mains cable	12
Using the transmitter	13
Switching the transmitter on/off	13
Deactivating the lock mode temporarily	14
Activating/deactivating the RF signal	14
Monitoring the audio signal via headphones	15
Synchronizing transmitters and EK 2000 IEM receivers via the infra-red interface	15
Using the operating menu	18
The buttons	18
Overview of the operating menu	18
Working with the operating menu	20
Adjusting settings via the operating menu	22
The main menu "Menu"	22
The extended menu "Advanced Menu"	25
Synchronizing the transmitter with the EK 2000 IEM receiver	30
Synchronizing the transmitter with an EK 2000 IEM receiver – individual operation	30
Synchronizing transmitters with EK 2000 IEM receivers – multi-channel operation	30
Using freely selectable transmission frequencies	31
Cleaning the transmitter	32
Recommendations and tips	33
Accessories	34
If a problem occurs	35
Specifications	36
Manufacturer Declarations	38
Index	39



Supplementary information can be found on the SR 2000 IEM and SR 2050 IEM product pages on our website at www.sennheiser.com.

Important safety instructions

1. Read these instructions.
2. Keep these instructions. Always include these instructions when passing the transmitter on to third parties.
3. Heed all warnings.
4. Follow all instructions.
5. Do not use this apparatus near water.
6. Clean only with a dry cloth.
7. Do not block any ventilation openings. Install in accordance with the manufacturer's instructions.
8. Do not install near any heat sources such as radiators, heat registers, stoves, or other apparatus (including amplifiers) that produce heat.
9. Do not defeat the safety purpose of the polarized or grounding-type plug. A polarized plug has two blades with one wider than the other. A grounding type plug has two blades and a third grounding prong. The wide blade or the third prong are provided for your safety. If the provided plug does not fit into your outlet, consult an electrician for replacement of the obsolete outlet.
10. Protect the power cord from being walked on or pinched, particularly at plugs, convenience receptacles, and the point where they exit from the apparatus.
11. Only use attachments/accessories specified by the manufacturer.
12. Use only with the cart, stand, tripod, bracket, or table specified by the manufacturer, or sold with the apparatus. When a cart is used, use caution when moving the cart/apparatus combination to avoid injury from tip-over.
13. Unplug this apparatus during lightning storms or when unused for long periods of time.
14. Refer all servicing to qualified service personnel.
Servicing is required when the apparatus has been damaged in any way, such as power supply cord or plug is damaged, liquid has been spilled or objects have fallen into the apparatus, when the apparatus has been exposed to rain or moisture, does not operate normally, or has been dropped.
15. To completely disconnect this apparatus from the AC mains, disconnect the power supply cord plug from the AC receptacle.
16. **WARNING:** To reduce the risk of fire or electric shock, do not expose this apparatus to rain or moisture.
17. Do not expose this equipment to dripping or splashing and ensure that no objects filled with liquids, such as vases, are placed on the equipment.
18. The mains plug of the power supply cord shall remain readily operable.



Hazard warnings on the rear of the transmitter



The label shown on the left is attached to the rear of the transmitter. The symbols on this label have the following meaning:



This symbol is intended to alert the user to the presence of uninsulated dangerous voltage within the transmitter's enclosure that may be of sufficient magnitude to constitute risk of fire or electric shock.



This symbol is intended to alert the user to the risk of electric shock if the transmitter is opened. There are no user serviceable parts inside. Refer servicing to qualified personnel only.



This symbol is intended to indicate the presence of important operating and maintenance instructions in the literature accompanying this transmitter.

Overloading

Do not overload wall outlets and extension cables as this may result in fire and electric shock.

Replacement parts

When replacement parts are required, be sure the service technician uses replacement parts specified by Sennheiser or those having the same characteristics as the original part. Unauthorized substitutions may result in fire, electric shock, or other hazards.

Safety check

Upon completion of any service or repairs to this device, ask the service technician to perform safety checks to determine that the device is in safe operating order.

Danger of hearing damage due to high volumes

This is a professional transmitter. Commercial use is subject to the rules and regulations of the trade association responsible. Sennheiser, as the manufacturer, is therefore obliged to expressly point out possible health risks arising from use.

This transmitter is capable of producing sound pressure exceeding 85 dB(A). 85 dB(A) is the sound pressure corresponding to the maximum permissible volume which is by law (in some countries) allowed to affect your hearing for the duration of a working day. It is used as a basis according to the specifications of industrial medicine. Higher volumes or longer durations can damage your hearing. At higher volumes, the duration must be shortened in order to prevent hearing damage. The following are sure signs that you have been subjected to excessive noise for too long a time:

- You can hear ringing or whistling sounds in your ears.
- You have the impression (even for a short time only) that you can no longer hear high notes.

Intended use

Intended use of the SR 2000 IEM and SR 2050 IEM transmitters includes:

- having read these instructions, especially the chapter "Important safety instructions" on page 2,
- using the device within the operating conditions and limitations described in this instruction manual.

"Improper use" means using the device other than as described in these instructions, or under operating conditions which differ from those described herein.

The SR 2000 IEM and SR 2050 IEM transmitters

With the SR 2000 IEM and SR 2050 IEM 2-channel/stereo monitoring transmitters, musicians, video and sound amateurs, reporters/broadcasters, etc. can directly monitor the received sound signals without troublesome cables or monitor speakers being required. In addition, the transmitters can also be used for any application where talkback signals are to be transmitted.

Features of the SR 2000 IEM and SR 2050 IEM transmitters:

- Optimized PLL synthesizer and microprocessor technology
- Stereo/mono selection
- HDX noise reduction system
- Switching bandwidth of up to 75 MHz
- Safe configuration of a multi-channel system using the WSM
- Easy setup of a multi-channel system using the [Easy Setup Sync](#) function

The frequency bank system

The transmitters are available in 5 UHF frequency ranges with up to 3,000 transmission frequencies per frequency range:

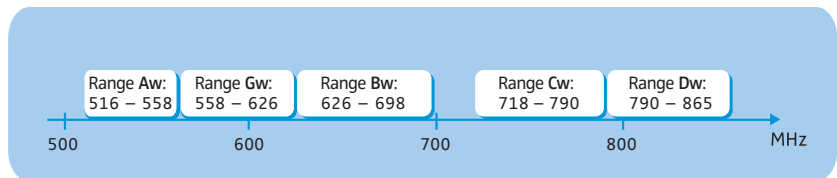

Each frequency range (Aw–Dw, Gw) offers 26 frequency banks with up to 32 channels each:

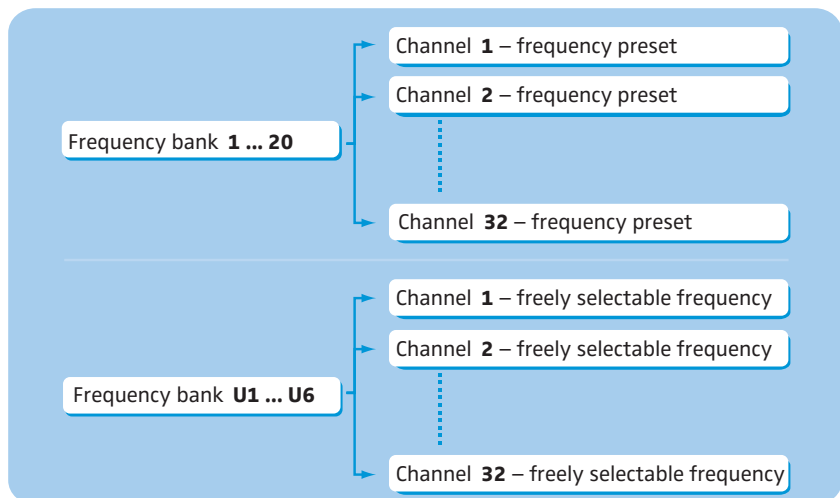

Each of the channels in the frequency banks “1” to “20” has been factory-preset to a fixed transmission frequency (frequency preset). The factory-preset frequencies within one frequency bank are intermodulation-free. These frequencies cannot be changed.

For an overview of the frequency presets, please refer to the supplied frequency information sheet. Updated versions of the frequency information sheet can be downloaded from the corresponding product page on our website at www.sennheiser.com.

The frequency banks “U1” to “U6” allow you to freely select and store transmission frequencies. It might be that these transmission frequencies are **not** intermodulation-free (see page 30).

Areas of application

The transmitters can be combined with the EK 2000 IEM receiver. For more information, visit our website at www.sennheiser.com.

This receiver is available in the same UHF frequency ranges and is equipped with the same frequency bank system with factory-preset frequencies. An advantage of the factory-preset frequencies is that

- a transmission system is ready for immediate use after switch-on,
- several transmission systems can be operated simultaneously on the preset frequencies without causing intermodulation interference.

Delivery includes

The packaging contains the following items:

- 1 SR 2000 IEM transmitter or 1 SR 2050 IEM twin transmitter
- 3 mains cables (with EU, UK and US plug)
- 1 rod antenna (SR 2000 IEM) or 2 rod antennas (SR 2050 IEM)
- 1 instruction manual
- 1 frequency information sheet
- 1 RF licensing information sheet
- 4 self-adhesive device feet

Product overview

Overview of the SR 2000 IEM/SR 2050 IEM transmitter



The SR 2050 IEM twin transmitter has the same operating elements as the SR 2000 IEM transmitter. All information contained in this instruction manual refers to both transmitters.

SR 2050 IEM

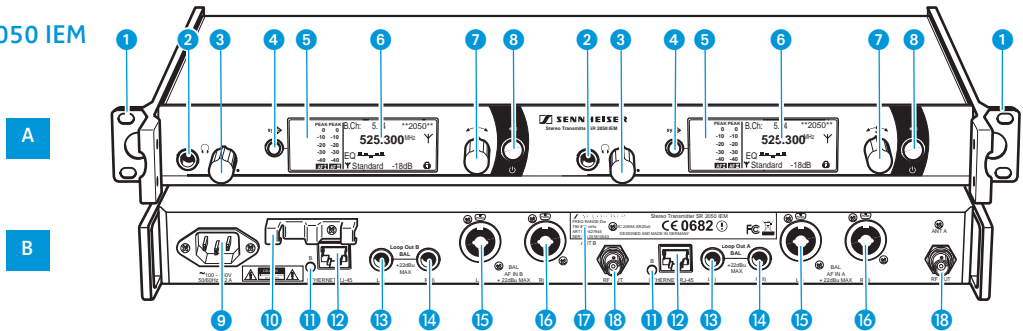

SR 2000 IEM

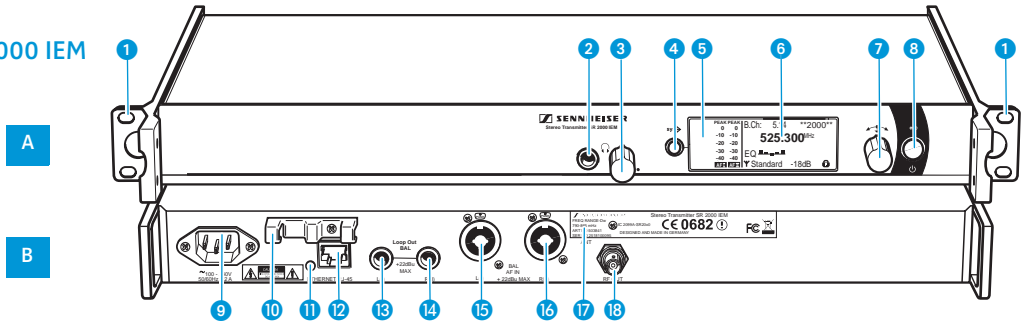

A Operating elements – front panel

- 1 Rack mount "ear"
- 2 Headphone output, 1/4" (6.3 mm) jack socket (I)
- 3 Headphone volume control
- 4 button, backlit
- 5 Infra-red interface
- 6 Display panel, backlit in orange
- 7 Jog dial
- 8 **STANDBY** button
operation indication (red backlighting)
ESC function (cancel)

B Operating elements – rear panel

- 9 3-pin mains socket
- 10 Cable grip for power supply DC cable
- 11 LED (yellow) for network activity indication*
- 12 LAN socket (**ETHERNET RJ-45**)*
- 13 Audio output left (**LOOP OUT BAL L (I)**),
1/4" (6.3 mm) jack socket*
- 14 Audio output right (**LOOP OUT BAL R (II)**),
1/4" (6.3 mm) jack socket*
- 15 Audio input left (**BAL AF IN L (I)**),
1/4" (6.3 mm) jack/XLR-3 combo socket*
- 16 Audio input right (**BAL AF IN R (II)**),
1/4" (6.3 mm) jack/XLR-3 combo socket*
- 17 Type plate
- 18 Antenna output (**RF OUT**), BNC socket*

During **mono** operation, the signal from the **left** audio input (1/4" (6.3 mm) jack/XLR-3 combo socket 15) is transmitted.

* These operating elements are available twice on the SR 2050 IEM twin transmitter and are labeled **A** and **B** respectively. **A** designates the left-hand transmitter, **B** the right-hand one (seen from the front).

Overview of the displays

After switch-on, the transmitter displays the standard display.

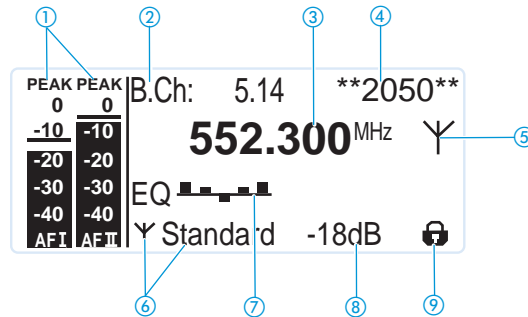

Display	Meaning
① Audio level "AF I" and "AF II" (Audio Frequency)	<p>PEAK PEAK 0 0 -10 -10 -20 -20 -30 -30 -40 -40 AF I AF II</p> <p>Modulation of the left (AF I) and right (AF II) audio channel with peak hold function</p> <p>When the transmitter is overmodulated frequently or for extended periods of time, the "PEAK" display is shown inverted. In addition, the display backlighting changes from orange to red and "AF PEAK" flashes in alternation with the standard display.</p> <p>During mono operation, only the "AF I" display is shown.</p>
② Frequency bank and channel	Current frequency bank and channel number
③ Frequency	Current transmission frequency
④ Name	Freely selectable name of the transmitter
⑤ Transmission icon	RF signal is being transmitted
⑥ Transmission power	Current transmission power
⑦ Equalizer setting	Current equalizer setting
⑧ Input sensitivity	Current input sensitivity for the audio signal available at the audio input sockets BAL AF IN L (I) 15 and BAL AF IN R (II) 16.
⑨ Lock mode icon	Lock mode is activated (see page 14)

Putting the transmitter into operation

Setting up the transmitter on a flat surface



Do not fit the device feet when mounting the transmitter into a 19" rack.

- ▶ Clean the base of the transmitter where you want to fix the device feet.
- ▶ Fit the device feet to the four corners of the transmitter.
- ▶ Place the transmitter on a flat, horizontal surface. Please note that the device feet can leave stains on delicate surfaces.

Mounting the transmitter into a 19" rack

CAUTION!



Risks when rack mounting the transmitter!

When installing the device in a closed or multi-rack assembly, please consider that, during operation, the ambient temperature, the mechanical loading and the electrical potentials will be different from those of devices which are not mounted into a rack.

- ▶ Make sure that the ambient temperature within the rack does not exceed the permissible temperature limit specified in the specifications.
- ▶ If necessary, provide additional ventilation.
- ▶ Make sure that the mechanical loading of the rack is even.
- ▶ When connecting to the power supply, observe the information indicated on the type plate. Avoid circuit overloading. If necessary, provide overcurrent protection.
- ▶ When rack mounting, please note that intrinsically harmless leakage currents of the individual mains units may accumulate, thereby exceeding the allowable limit value. As a remedy, ground the rack via an additional ground connection.

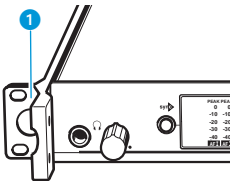

- ▶ Slide the transmitter into the 19" rack.
- ▶ Secure the rack mount "ears" ① to the rack using four screws (not included in the delivery).

Connecting the antennas

You have the following options:

- For professional use, we recommend connecting a remote antenna and, if necessary, using Sennheiser antenna accessories (see next section and the chapter "Connecting several transmitters to a remote antenna" on page 9).
- If the transmitter is to be put into operation without a large amount of installation work, you can:
 - connect the supplied rod antenna to the rear of the transmitter (see page 9) or
 - use the optional GA 3030 AM antenna front mount kit (see page 9).

Connecting and positioning a remote antenna

Use a remote antenna when the transmitter position is not the best antenna position for optimum transmission. You can choose between two antennas (see “Accessories” on page 34):

- A 2003 UHF passive directional broadband antenna
 - A 1031 passive omni-directional broadband antenna
- ▶ Use a low-attenuation 50-Ω cable to connect the antenna to the transmitter.
 - ▶ If possible, use a short antenna cable and as little connections as possible, since long cables and many connectors lead to an attenuation of the antenna signal.
 - ▶ Position the antenna in the same room in which the transmission takes place.
 - ▶ Observe a minimum distance of 1 m between the antenna and metal objects (including reinforced concrete walls).



You can connect several transmitters to the same remote antenna (see next section).

Connecting several transmitters to a remote antenna

To make multi-channel systems, you should use the AC 3200 antenna combiner (optional accessory). The AC 3200 allows you to operate up to eight transmitters with a single antenna without virtually any intermodulation.

- ▶ Connect the AC 3200 antenna combiner to the BNC socket 18.

Connecting the rod antenna to the rear of the transmitter

The supplied rod antenna 19 is suitable for all applications where the transmitter is to be put into operation without a large amount of installation work.

- ▶ Connect the rod antenna 19 to the BNC socket 18.

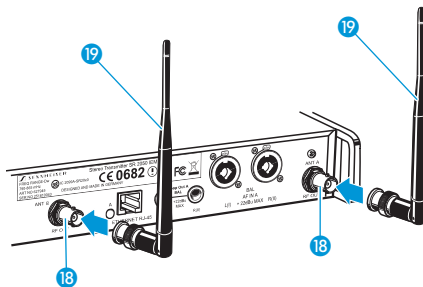

Mounting the antennas to the front of the transmitter

To mount the antenna connections to the front of the transmitter, you require the GA 3030 AM antenna front mount kit (optional accessory). The GA 3030 AM consists of:

Putting the transmitter into operation

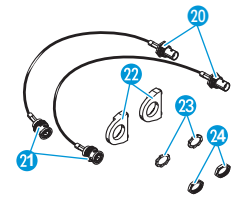

- 2 BNC extension cables (screw-in BNC socket 20 to BNC connector 21),
- 2 antenna holders 22,
- 4 screws,
- 2 washers 23,
- 2 nuts 24.

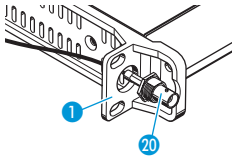

▶ Guide the BNC connector 21 of the BNC extension cable through the hole in the rack mount "ear" 1.

▶ Connect the BNC connector 21 to the antenna output 18.

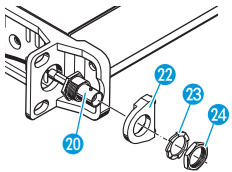

▶ Screw the antenna holder 22 to the BNC socket 20 using the supplied washer 23 and nut 24.

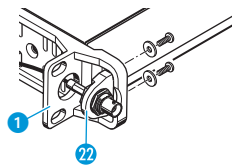

▶ Secure the antenna holder 22 to the rack mount "ear" 1 of the transmitter using two of the supplied screws.

If you are using the SR 2050 IEM twin transmitter:

▶ Mount the second BNC extension cable in the same way.

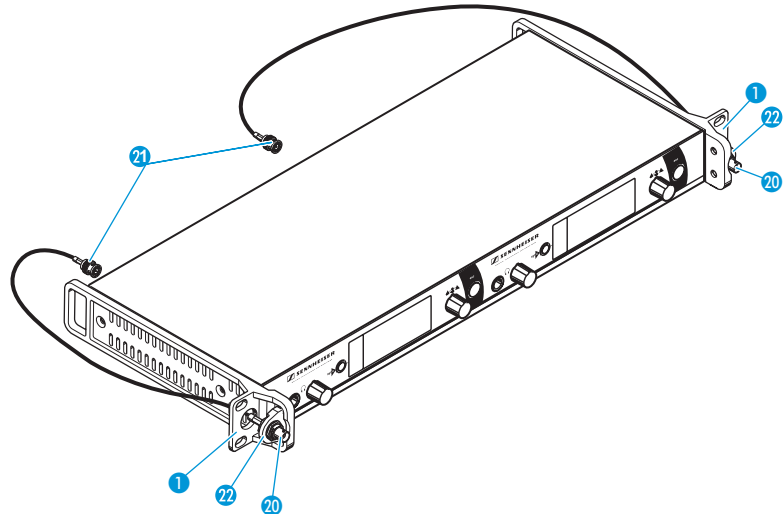

▶ Slide the transmitter into the 19" rack.

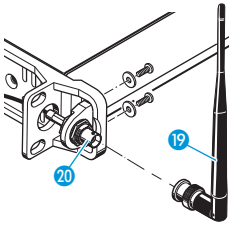

- ▶ Connect the rod antennas 19 to the two BNC sockets 20.

Connecting an audio source to the input sockets

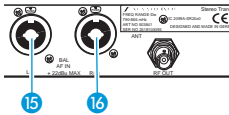

- ▶ Use a suitable cable to connect the output of the audio source (e.g. mixing console) to the ¼" (6.3 mm) jack/XLR-3 combo socket BAL AF IN L (I) 15 and/or BAL AF IN R (II) 16.
- ▶ Adjust the output level of your audio source.
- ▶ Via the operating menu, adjust the transmitter's input sensitivity. The input sensitivity is adjusted via the "Sensitivity" menu item and is common for both inputs (see page 22).



You can connect several transmitters to the same audio source (see next chapter).

Daisy chaining audio signals

You can transmit the same audio signal (e.g. the sum of all audio channels of a mixing console) to several receivers of a multi-channel system. To do so, you have to daisy chain this audio signal from one transmitter to the next via the output sockets LOOP OUT BAL L (I) 13 or LOOP OUT BAL R (II) 14. The audio signal is then transmitted by all transmitters on one of the two channels L (I) or R (II). The second channel allows you to transmit an individual audio signal (e.g. the instrument of a musician). Using the balance setting on the receiver, you can then adjust the relative levels of the sum of all audio channels and the individual audio signal. For this, the transmitter has to be set to stereo mode and the receiver to Focus mode.

To daisy chain an audio signal from one transmitter to the next:

- ▶ Route a signal from the audio source to the input socket (in this example: BAL AF IN R(II) 16) of transmitter A.

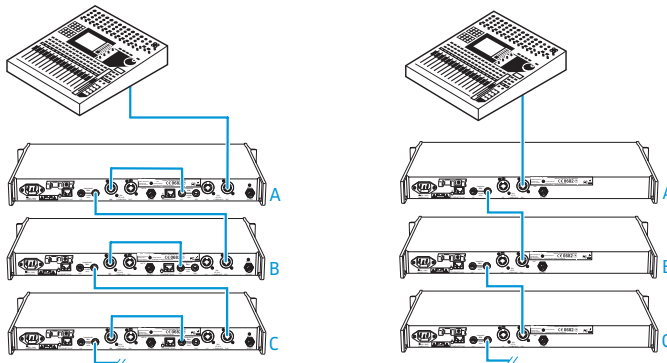

- ▶ Connect the output socket **LOOP OUT BAL R(II)** 14 of transmitter A to the input socket **BAL AF IN R(II)** 16 of transmitter B.
- ▶ Connect the output socket **LOOP OUT BAL R(II)** 14 of transmitter B to the input socket **BAL AF IN R(II)** 16 of transmitter C.
- ▶ Repeat for the other transmitters.



The AF output sockets **LOOP OUT BAL L(I)** 13 and/or **LOOP OUT BAL R(II)** 14 will work only when the transmitter is switched on and powered.

Connecting devices to the output sockets

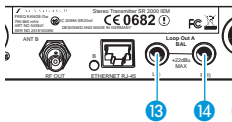

- ▶ Use a suitable cable to connect the audio input of a device (e.g. a mixing console or an additional SR 2000 IEM or SR 2050 IEM) to the output socket **LOOP OUT BAL L (I)** 13 and/or **LOOP OUT BAL R (II)** 14 (see also preceding chapter).



The signal received from the AF input sockets **BAL AF IN L(I)** 15 and **BAL AF IN R(II)** 16 is actively buffered and then routed to the output sockets **LOOP OUT BAL L(I)** 13 and **LOOP OUT BAL R(II)** 14. The AF output sockets will therefore work only when the transmitter is switched on and powered.

Connecting transmitters in a network

You can connect several transmitters in a network. The transmitters are remote controlled via a PC running the “**Wireless Systems Manager**” (WSM) software. This software will assist in the quick and safe configuration of multi-channel systems.



The “**Wireless Systems Manager**” (WSM) software can be downloaded from our website at www.sennheiser.com.

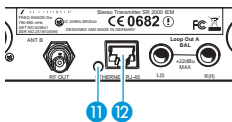

- ▶ Connect a standard network cable (at least Cat 5) to the LAN socket 12 of the transmitter.
- ▶ Connect your transmitters to an Ethernet switch.
- ▶ Connect a PC to the Ethernet switch.
When a transmitter is properly connected to the Ethernet switch or the PC, the yellow LED 11 at the rear of the transmitter lights up.

For further information on network operation using the WSM, refer to page 30.

Connecting the mains cable

CAUTION!

Damage due to electric current!

If you connect the transmitter to an unsuitable power supply, this can cause damage to the device.

- ▶ Use the supplied mains cable to connect the transmitter to the mains (100 to 240 V AC, 50 or 60 Hz).
- ▶ Ensure a reliable mains ground connection of the transmitter – especially when you are using multi-outlet power strips or extension cables.

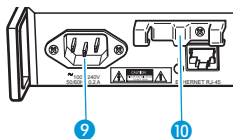

- ▶ Pass the mains cable through the cable grip 10.
- ▶ Connect the mains cable to the mains socket 9.
- ▶ Plug the mains plug into the wall socket.

Using the transmitter

To establish a transmission link, proceed as follows:

1. Switch the transmitter on (see next section).
2. Switch the EK 2000 IEM receiver on (see the instruction manual of the receiver).
The transmission link is established.



It is vital to observe the notes on frequency selection on page 30.

If you cannot establish a transmission link between the transmitter and the EK 2000 IEM receiver, read the chapter "Synchronizing the transmitter with the EK 2000 IEM receiver" on page 30.

Switching the transmitter on/off

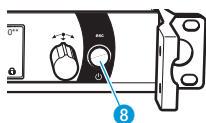

To switch the transmitter **on** (online operation):



- ▶ Briefly press the **STANDBY** button 8.
The transmitter switches on and the standard display appears.
The transmitter transmits an RF signal and the transmission icon 5 is displayed.

To switch the transmitter on and to **deactivate the RF signal on switch-on** (offline operation):



- ▶ Keep the **STANDBY** button 8 pressed until "RF Mute On?" appears on the display panel.



- ▶ Press the jog dial.
The transmission frequency is displayed but the transmitter does not transmit an RF signal. The transmission icon 5 is not displayed. In addition, the display backlighting changes from orange to red and "RF Mute" flashes in alternation with the standard display.

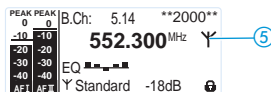

Use this function to prepare a transmitter for use during live operation without causing interference to existing transmission links.

To **activate** the RF signal:



- ▶ Press the **STANDBY** button 8.
"RF Mute Off?" appears on the display panel.

- ▶ Press the jog dial.
The transmission icon ⑤ is displayed again.

To switch the transmitter to **standby mode**:

- ▶ If necessary, deactivate the lock mode (see page 14)
- ▶ Keep the **STANDBY** button ⑧ pressed until "OFF" appears on the display panel.
The transmitter switches to standby mode.



When in the operating menu, pressing the **STANDBY** button ⑧ will cancel your entry (ESC function) and return you to the standard display.

The **STANDBY** button ⑧ is backlit in red both during operation and in standby mode.

To completely switch the transmitter **off**:

- ▶ Disconnect the transmitter from the mains by unplugging the mains plug from the wall socket.
The backlighting of the **STANDBY** button ⑧ goes off.

Deactivating the lock mode temporarily

You can activate or deactivate the automatic lock mode via the "Auto Lock" menu item (see page 25). If the lock mode is activated, you have to temporarily deactivate it in order to be able to operate the transmitter:

- ▶ Press the jog dial.
"Locked" appears on the display panel.
- ▶ Turn the jog dial.
"Unlock?" appears on the display panel.
- ▶ Press the jog dial.
The lock mode is temporarily deactivated.
 - When you are in the operating menu, the lock mode remains deactivated until you exit the operating menu.
 - When the standard display is shown, the lock mode is automatically activated after 10 seconds.

The lock mode icon ⑨ flashes prior to the lock mode being activated again.

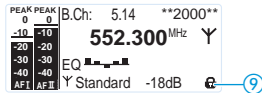

Activating/deactivating the RF signal

To **deactivate** the RF signal:



- ▶ When the standard display is shown on the display panel, press the **STANDBY** button.
"RF Mute On?" appears on the display panel.

- ▶ Press the jog dial.
The RF signal is deactivated. The transmission icon ⑤ is not displayed. In addition, the display backlighting changes from orange to red and “RF Mute” flashes in alternation with the standard display.

To **activate** the RF signal:

- ▶ Press the **STANDBY** button.
“RF Mute Off?” appears on the display pane.
- ▶ Press the jog dial.
The RF signal is activated and the transmission icon ⑤ is displayed. The display backlighting changes from red to orange.

To **deactivate the RF signal** on **switch-on**:

- ▶ See “offline operation” on page 13.

Monitoring the audio signal via headphones

CAUTION!



Danger of hearing damage!

Listening at high volume levels for long periods can lead to permanent hearing defects.

- ▶ Set the headphone volume control ③ to the minimum position before putting the headphones on.
- ▶ Do **not** continuously expose yourself to high volumes.

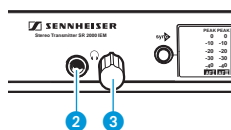

- ▶ Set the headphone volume control ③ to the minimum position.
- ▶ Connect headphones with a ¼" (6.3 mm) stereo jack plug to the headphone output ②.
- ▶ Gradually increase the volume and monitor the audio signal with the lowest possible volume.



Synchronizing transmitters and EK 2000 IEM receivers via the infra-red interface

Synchronization allows you to quickly and easily transfer transmitter and receiver settings from one device to the other, especially if you want to configure a multi-channel system. There are two transfer directions:

1. **Easy Setup Sync:** Transfer from the receiver to one or several transmitters

Once you have performed a frequency preset scan with a receiver, you can use the **Easy Setup Sync** function to transfer unused frequency presets from the receiver to the transmitters via the infra-red interface. In order to set up a multi-channel system, you use the diversity receiver to transfer the first unused channel from the selected frequency bank to the first transmitter and the next unused channel to the second transmitter and so on, thus ensuring that all transmitters of a multi-channel system operate on suitable frequencies.

2. **Sync:** Transfer from a transmitter to a receiver

Once you have selected and set the desired receiver settings on the transmitter (either manually or using the **Easy Setup Sync** function), you transfer these settings to a receiver. This configures the receiver and establishes a transmission link between transmitter and receiver.

When carrying out the **Sync** function, the transmitter's current frequency bank and channel setting as well as the receiver parameters adjusted via the "Sync Settings" submenu (see page 27) are transferred to the EK 2000 IEM receiver via the infra-red interface.

Carrying out an Easy Setup Sync or a Sync function

The following assumes that you are using the **Easy Setup Sync** function for setting up a multi-channel system. You can also use the **Easy Setup Sync** function for establishing a transmission link between one transmitter and one EK 2000 IEM receiver.

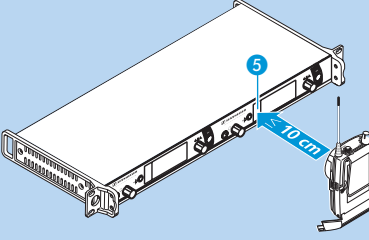
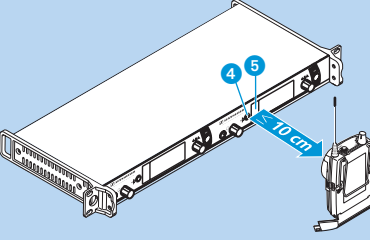

Easy Setup Sync	Sync
<ul style="list-style-type: none"> ▶ Switch all transmitters and one receiver on. 	<ul style="list-style-type: none"> ▶ Switch the transmitter and the receiver on.
<ul style="list-style-type: none"> ▶ On all transmitters, call up the "Easy Setup" menu item. The text "Easy Setup Sync" and the sync icon appear on the display panels of the transmitters. The RF signal of the transmitters is automatically deactivated. 	<ul style="list-style-type: none"> ▶ Press the sync button 4 on the transmitter. The sync icon appears on the display panel of the transmitter.
<ul style="list-style-type: none"> ▶ Use your receiver to perform a frequency preset scan (Scan New List). ▶ Select a channel within a frequency bank with a sufficient number of unused channels (Current List). 	<p>–</p>
	
<ul style="list-style-type: none"> ▶ Place the infra-red interface of the receiver (see the instruction manual of the receiver) in front of the infra-red interface 5 of the first transmitter. 	<ul style="list-style-type: none"> ▶ Place the infra-red interface of the receiver (see the instruction manual of the receiver) in front of the infra-red interface 5 of your transmitter.

Easy Setup Sync	Sync
<p>The first unused frequency preset is transferred from the receiver to the transmitter.</p> <p>When the transfer is completed, the display panel of the transmitter displays the numbers of the transferred frequency bank and channel.</p> <p>Please note that the transmitter does not automatically store the frequency bank and channel setting.</p>	<p>The current frequency bank and channel setting as well as the parameters adjusted via the "Sync Settings" menu item are transferred from the transmitter to the receiver.</p> <p>When the transfer is completed, "✓" appears on the display panel of the transmitter. The transmitter then switches back to the standard display.</p> <p>The transferred parameters are automatically adjusted and stored by the receiver. The transmission link between transmitter and receiver is now established.</p>
<p>▶ Place the infra-red interface of the diversity receiver in front of the infra-red interfaces of the remaining transmitters, one after the other.</p> <p>In each case, the next unused frequency preset is transferred from the receiver to the transmitter.</p>	<p>–</p>
<p>Either:</p> <p>▶ Store the frequency bank and channel setting by pressing the jog dial on your transmitters.</p> <p>The RF signal is activated. You can carry out the Sync function (see right-hand column) at a later time to establish a transmission link between transmitters and receivers.</p>	<p>–</p>
<p>Or:</p> <p>▶ Immediately synchronize your receivers with your transmitters by carrying out the Sync function (see right-hand column).</p> <p>The sync icon in the left lower corner of the transmitter display indicates that the Sync function can be carried out. The transmission link between transmitters and receivers is established.</p>	<p>–</p>
<p>–</p>	<p>To cancel the transfer:</p> <p>▶ Press the STANDBY button on the transmitter.</p> <p>"X" appears on the display panel of the transmitter. "X" also appears if no suitable receiver was found.</p>

Using the operating menu

A special feature of the Sennheiser 2000 series is the consistent, intuitive menu structure of transmitters and receivers. As a result, adjustments to the settings can be made quickly – even in stressful situations, for example on stage or during a live show or presentation.

The buttons

Button	Function of the button
Press the STANDBY button 	<ul style="list-style-type: none"> Switches the transmitter on and off Cancels the entry and returns to the standard display (ESC function) Activates/deactivates the RF signal (special function, see page 14)
Press the jog dial 	<ul style="list-style-type: none"> Changes from the standard display to the operating menu Calls up a menu item Enters a submenu Stores the settings and returns to the operating menu
Turn the jog dial 	<ul style="list-style-type: none"> Changes to the next/previous menu item Changes the setting of a menu item

Overview of the operating menu

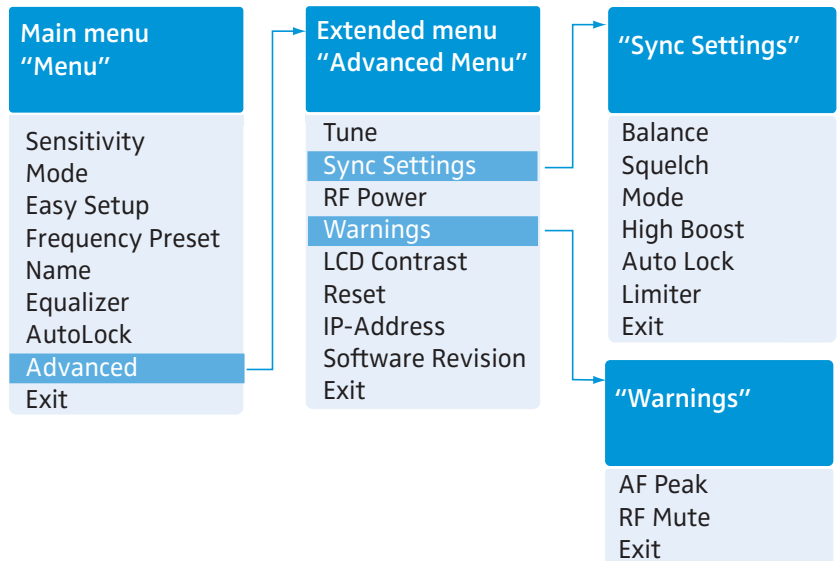

Display	Function of the menu item	Page
Main menu "Menu"		22
Sensitivity	Adjusts the input sensitivity (0 to -42 dB in steps of 3 dB)	22
Mode	Selects mono or stereo operation	22
Easy Setup	Deactivates the RF signal and activates the Easy Setup Sync function	30
Frequency Preset	Sets the frequency bank and the channel	23
Name	Enters a freely selectable name	24
Equalizer	Changes the frequency response of the output signal using a graphic equalizer (+/- 12 dB in steps of 2.4 dB)	24
AutoLock	Activates/deactivates the automatic lock mode	25
Advanced	Calls up the extended menu "Advanced Menu"	25
Exit	Exits the operating menu and returns to the standard display	-
Extended menu "Advanced Menu"		25
Tune	Sets the transmission frequencies for the frequency banks "U1" to "U6"	25
	Sets the frequency bank, the channel and the transmission frequency (frequency banks "U1" to "U6")	26
Sync Settings	Adjusts the receiver parameters and activates/deactivates their transfer to the receivers	27
RF Power	Adjusts the transmission power (Low, Standard or High)	28
Warnings	Calls up "Warnings" (see below)	28
LCD Contrast	Adjusts the contrast of the display panel (adjustable in 16 steps)	28
Reset	Resets the settings made in the operating menu	28
IP-Address	Adjusts the IP address of the transmitter	29
Software Revision	Displays the current software revision	29
Exit	Exits the extended menu "Advanced Menu" and returns to the main menu	-
"Warnings"		
Activates/deactivates warnings (color change and warning messages)		
AF Peak	Audio overmodulation	28
RF Mute	RF signal is deactivated	
Exit	Exits "Warnings" and returns to the extended menu "Advanced Menu"	

Working with the operating menu



If the lock mode is activated, you have to deactivate it In order to be able to work with the operating menu (see page 14).

By way of example of the “Frequency Preset” menu, this section describes how to use the operating menu.

Changing from the standard display to the operating menu



- Press the jog dial.
The standard display is replaced by the main menu. The last selected menu item is displayed.

Menu
Sensitivity
Mode
Easy Setup
Frequency Preset
Name
Equalizer
Auto Lock
Advanced
Exit

Selecting a menu item



- Turn the jog dial to change to the “Frequency Preset” menu item.
The current setting of the selected menu item is displayed:

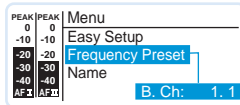

Changing and storing settings

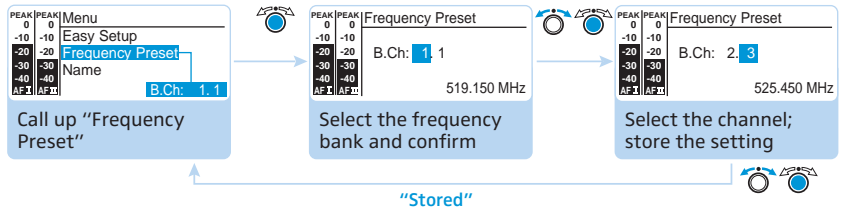

- Press the jog dial to call up the menu item.



- Turn the jog dial to set the frequency bank.



- Press the jog dial to confirm your selection.



- Turn the jog dial to set the channel.



- Press the jog dial to store the setting.



By briefly turning the jog dial to the left or right, the display jumps either forwards or backwards to the next menu item or setting. If you turn the jog dial to the left or right and hold it in this position, the display cycles continuously ("fast search" function).

Canceling an entry



- ▶ Press the **STANDBY** button to cancel the entry.
The standard display appears on the display panel.

To subsequently return to the last edited menu item:



- ▶ Press the jog dial repeatedly until the last edited menu item appears.

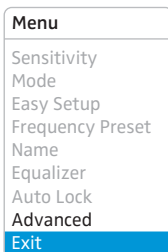

Exiting a menu item



- ▶ Change to the "Exit" menu item.



- ▶ Confirm your selection.
You return to the next higher menu level or you exit the operating menu and return to the standard display.

To directly return to the standard display:



- ▶ Press the **STANDBY** button.

Adjusting settings via the operating menu

The main menu "Menu"

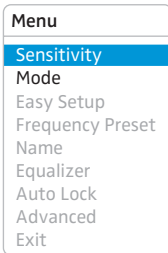

Adjusting the input sensitivity – "Sensitivity"

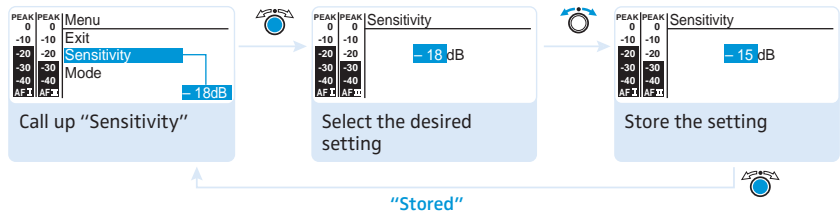

Adjustment range: 0 to -48 dB, adjustable in steps of 3 dB

Via the "Sensitivity" menu item, you can adjust the transmitter's input sensitivity to the output signal of the audio source. The adjusted input sensitivity is common for both audio inputs of the transmitter.



The audio level display "AF" always indicates the audio level, even if the transmitter is muted, e.g. allowing you to check the adjusted sensitivity before live operation.

Input sensitivity is adjusted ...	Effect/display
... too high	Close talking distances, speakers with loud voices or loud music passages cause overmodulation in the transmission link. The audio level display "AF I" and/or "AF II" ① shows full deflection for the duration of the overmodulation.
... correctly	The audio level display "AF I" and/or "AF II" ① shows full deflection only during the loudest passages.
... too low	The transmission link is undermodulated. This results in a signal with high background noise.

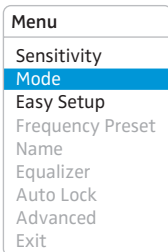

Selecting mono or stereo operation – "Mode"

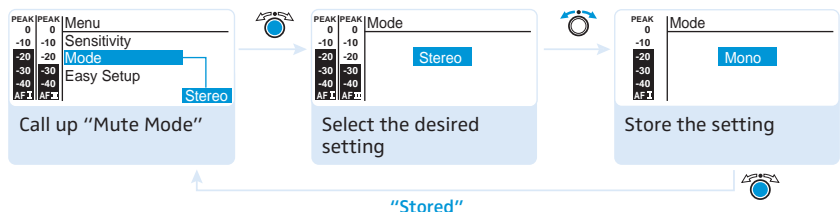

- ▶ Select **“Stereo”** if you want to transmit the audio signals from the left and right audio input (BAL AF IN L (I) 15 and BAL AF IN R (II) 16).
- ▶ Select **“Mono”** if you only want to transmit the audio signal from the left audio input BAL AF IN L (I) 15.



During mono operation, you have to deactivate the pilot tone evaluation on your EK 2000 IEM receiver in order to ensure that the receiver outputs the same signal on channel I and II.

Starting synchronization – “Easy Setup”

For a detailed description of the **Easy Setup** function, refer to page 15.

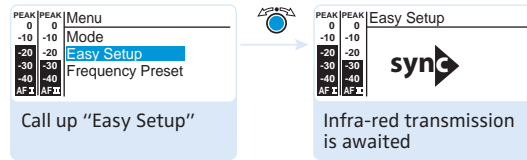
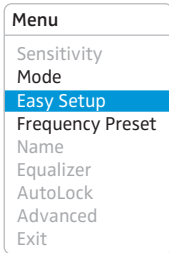

- ▶ Call up **“Easy Setup”** to transfer an unused frequency preset from the EK 2000 IEM receiver to the transmitter via the infra-red interface (see page 15). The RF signal of the transmitter is automatically deactivated (**“RF Mute”** flashes) and the transmitter awaits the data transfer.

If you do not want to start the transfer or to cancel the transfer:

- ▶ Press the **STANDBY** button.

Selecting the frequency bank and the channel manually – “Frequency Preset”

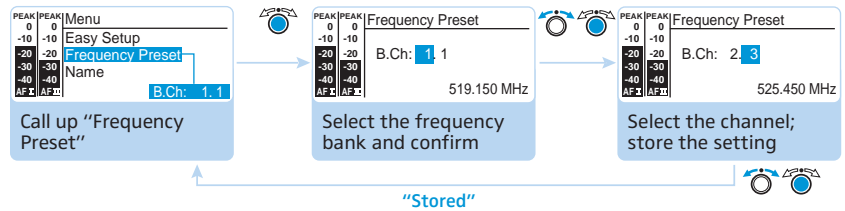
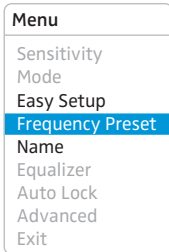

When you are in the **“Frequency Preset”** menu item, the RF signal is deactivated.

Overview of the frequency banks and channels:

Frequency bank	Channels	Type
“1” to “20”	up to 32 per frequency bank	System bank: frequencies are factory-preset
“U1” to “U6”	up to 32 per frequency bank	User bank: frequencies are freely selectable (see page 25)



When setting up multi-channel systems, please observe the following:

Only the factory-preset frequencies within one frequency bank ("1" to "20") are intermodulation-free. It is vital to observe the notes on frequency selection on page 30.

- Menu
- Sensitivity
- Mode
- Easy Setup
- Frequency Preset
- Name**
- Equalizer
- Auto Lock
- Advanced
- Exit

Entering a name – "Name"

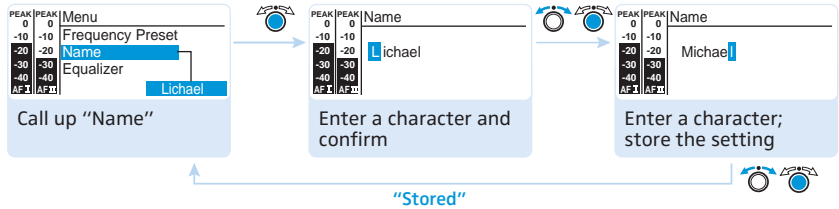

Via the "Name" menu item, you can enter a freely selectable name (e.g. the name of the performer) for the transmitter. The name is displayed on the standard display. The name can consist of up to 8 characters such as:

- letters (without pronunciation marks),
- numbers from 0 to 9,
- special characters and spaces.

To enter a name, proceed as follows:

- Turn the jog dial to select a character.
- Press the jog dial to change to the next segment/character or to store the complete entry.

- Menu
- Sensitivity
- Mode
- Easy Setup
- Frequency Preset
- Name
- Equalizer**
- Auto Lock
- Advanced
- Exit

Using the equalizer

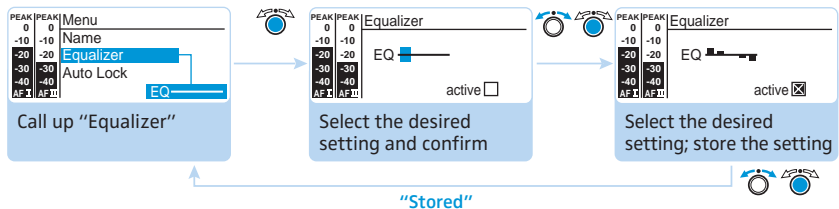

Adjustment range: +/- 12 dB, adjustable in steps of 2.4 dB

You can change the treble and bass of the audio output signal in 5 frequency ranges.

Display	Frequency range
	20 - 100 Hz
	100 - 300 Hz

Display	Frequency range
	300 Hz - 1 kHz
	1 - 3 kHz
	3 - 10 kHz

To change the treble and bass of the audio output signal, proceed as follows:



Turn the jog dial to boost or cut the frequency range.



Press the jog dial to change to the next frequency range or to store the complete entry.

Menu
Sensitivity
Mode
Easy Setup
Frequency Preset
Name
Equalizer
Auto Lock
Advanced
Exit

Activating/deactivating the automatic lock mode – “Auto Lock”

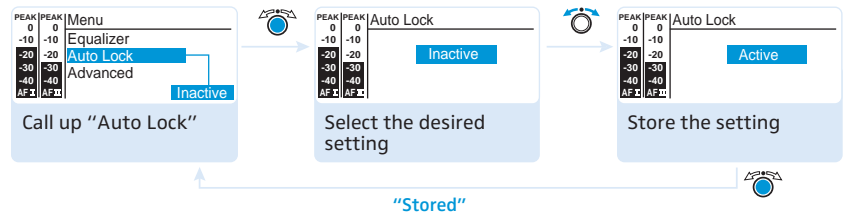

The lock mode prevents that the plug-on transmitter is accidentally switched off or programmed during operation. The lock mode icon on the standard display indicates that the lock mode is activated. For information on how to use the lock mode, refer to page 14.



Turn the jog dial to select the desired setting.

The extended menu “Advanced Menu”

Advanced Menu
Tune
Sync Settings
RF Power
Warnings
LCD Contrast
Reset
IP-Address
Software Revision
Exit

Setting the transmission frequencies and the frequency banks “U1” to “U6” – “Tune”



When you have selected one of the system banks and then select the “Tune” menu, the transmitter automatically switches to channel 1 of the frequency bank “U1”. In this case, “U1.1” briefly appears on the display panel.

Upon delivery, the channels of the frequency banks “U1” to “U6” are not assigned a transmission frequency.

When you are in the “Tune” menu item, the RF signal is deactivated.

Via the "Tune" menu item, you can:

1. set a transmission frequency to be stored in the current channel of the frequency bank ("U1" to "U6")
2. or select a frequency bank ("U1" to "U6") and a channel and assign this channel a transmission frequency.

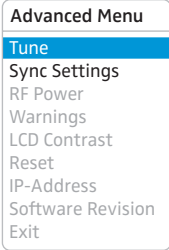

Setting a transmission frequency for the current channel

▶ Turn the jog dial until the "Tune" menu item appears.

▶ Press the jog dial. The frequency selection appears.

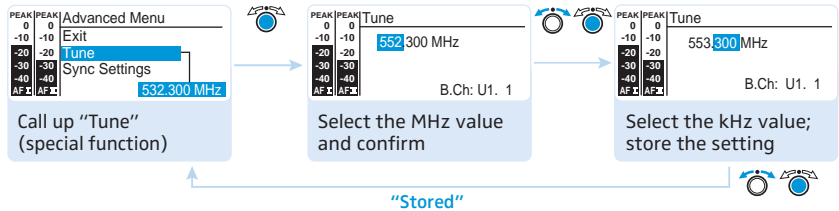

It is vital to observe the notes on frequency selection on page 30.

▶ Set the desired frequency.

▶ Press the jog dial. Your settings are stored. The "Tune" menu item appears.

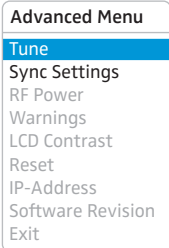

Selecting a frequency bank and a channel and assigning this channel a transmission frequency

▶ Turn the jog dial until the "Tune" menu item appears.

▶ Keep the jog dial pressed until the frequency bank selection appears.

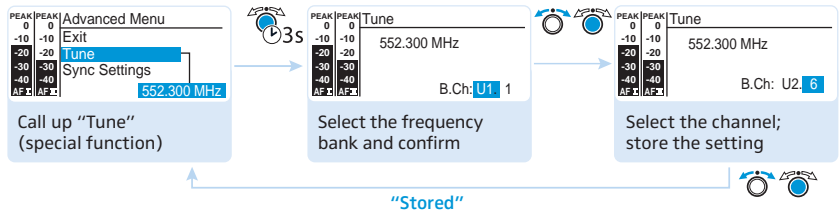

▶ Set the desired frequency bank.

▶ Press the jog dial. The channel selection appears.

▶ Set the desired channel.



▶ Press the jog dial.
The frequency selection appears.

▶ Set the desired frequency.



▶ Press the jog dial.
Your settings are stored. The “Tune” menu item appears.

Advanced Menu
Tune
Sync Settings
RF Power
Warnings
LCD Contrast
Reset
IP-Address
Software Revision
Exit

Adjusting the receiver parameters and activating/deactivating their transfer to the receiver – “Sync Settings”

Via the “Sync Settings” submenu, you can adjust the following parameters for the EK 2000 IEM receiver.

Menu item	Transferred receiver parameter
Balance	Balance or Focus setting (“-15”/“+15”)
Squelch	Squelch setting (“5 dB” ... “25 dB”)
Mode	Audio mode setting (“Stereo”/“Focus”)
High Boost	Treble boost setting for output signal (“flat”/“High boost” (8 dB at 10 kHz))
Auto Lock	Lock mode setting (“Active”/“Inactive”)
Limiter	Limiter setting (“-18 dB”, “-12 dB”, “-6 dB”, “Off”)
Exit	Exits the “Sync Settings” submenu and returns to the extended menu “Advanced Menu”

You can specify for each parameter whether it is to be transferred to the receiver during synchronization.

Parameter	Transfer is ...
	... deactivated
	... activated

By pressing the **sync** button on the transmitter, the parameters are transferred from the transmitter to the receiver (see page 15).

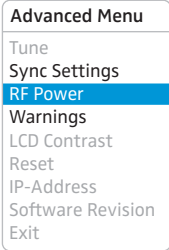

Adjusting the transmission power – “RF Power”

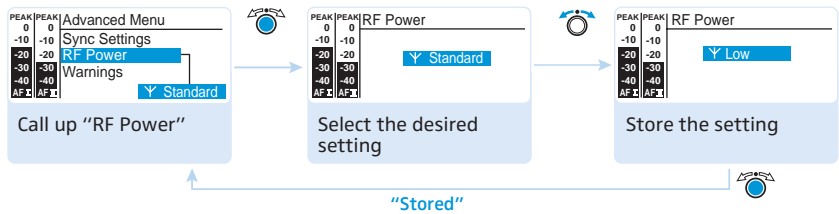

Via the “RF Power” menu item, you can adjust the transmission power in three steps (Low, Standard, High).



It is vital to observe the notes on the enclosed frequency information sheet!

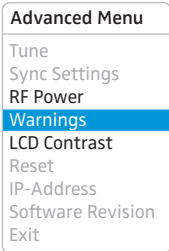

Activating/deactivating warning messages – “Warnings”

Via the “Warnings” menu item, you can activate or deactivate different warning messages.

Setting	Warning message with color change on the standard display	Trigger
AF Peak	“AF Peak”	Audio overmodulation
RF Mute	“RF Mute”	RF signal is deactivated (see page 14)

Adjusting the contrast of the display panel – “LCD Contrast”

You can adjust the contrast of the display panel in 16 steps.

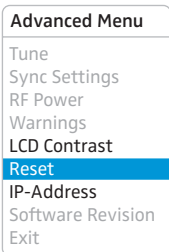

Resetting the settings made in the operating menu – “Reset”

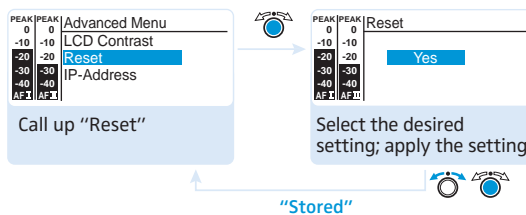

When resetting the settings made in the operating menu, only the selected settings for the pilot tone and for the frequency banks “U1” to “U6” remain unchanged. For an overview of the factory-preset default settings, refer to the enclosed frequency information sheet.

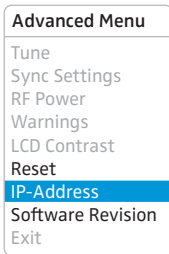

Adjusting the network configuration – “IP Address”

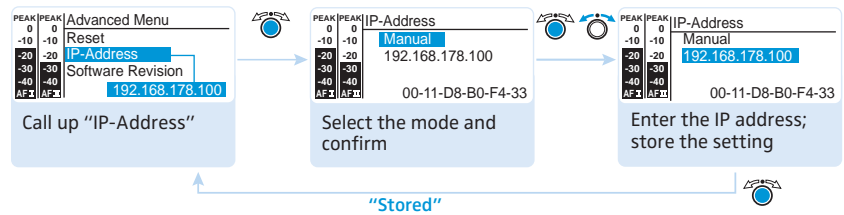

You can either automatically allocate or manually enter an IP address. This menu item also shows the transmitter's unique and unchangeable MAC address. In order to ensure safe communication between transmitters in multi-channel systems (see page 30), we recommend using automatic allocation of IP addresses.

Displaying the software revision – “Software Revision”

You can display the current software revision of the transmitter.

- For information on software updates, visit the corresponding product page on our website at www.sennheiser.com.

Synchronizing the transmitter with the EK 2000 IEM receiver

When synchronizing your transmitter with the EK 2000 IEM receiver, please observe the following:

-
- ▶  Only use a transmitter and a receiver from the same frequency range (see the type plates on the transmitter and the receiver).
 - ▶ Make sure that the desired frequencies are listed in the enclosed frequency information sheet. You can also contact your Sennheiser partner who will be pleased to calculate intermodulation-free frequencies for you.
 - ▶ Make sure that the desired frequencies are approved and legal in your country and, if necessary, apply for an operating license.
 - ▶ The frequency information sheet can also be downloaded from the corresponding product page on our website at www.sennheiser.com.
-

Synchronizing the transmitter with an EK 2000 IEM receiver – individual operation

Upon delivery, transmitter and receiver are synchronized with each other. If, however, you cannot establish a transmission link between transmitter and receiver, you have to synchronize the channels of the devices:

- ▶ First carry out the **Easy Setup Sync** function (see table on page 16, left-hand column). The transmitter is set to a suitable frequency.
- ▶ Then carry out the **Sync** function (see table on page 16, right-hand column). This establishes a transmission link between the transmitter and the receiver.

Alternatively, you can set the channel on the transmitter manually:

- ▶ Make sure that you set the transmitter to the same frequency bank and the same channel as the receiver.

Synchronizing transmitters with EK 2000 IEM receivers – multi-channel operation

Network operation

In multi-channel operation, the transmitters are remote controlled via a PC running the **“Wireless Systems Manager”** (WSM) software.

-
- ▶  Advantages of controlling the transmitters via the **“Wireless Systems Manager”** (WSM) software:
 - Detailed overview of all transmission and receiving channels
 - Remote control of all transmitters in the network
 - Combination of transmitters of different frequency ranges (see page 4).
-

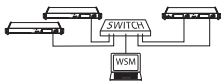

- ▶ Connect your transmitters and your PC in a network (see page 12).
- ▶ Switch your transmitters and your PC on.
- ▶ Launch the **“Wireless Systems Manager”** (WSM) software.
- ▶ To set up your multi-channel system, proceed as described in the instruction manual of the **“Wireless Systems Manager”** (WSM) software.

Operation without network

- ▶ First carry out the **Easy Setup Sync** function (see table on page 16, left-hand column). The transmitter is set to a suitable frequency.
- ▶ Then carry out the **Sync** function once for each transmitter/receiver pair (see table on page 16, right-hand column). This establishes a transmission link between the transmitter and the receiver.

Using freely selectable transmission frequencies

You can also freely select the frequencies and store these frequencies in the frequency banks "U1" to "U6".

If you want to use the frequency banks "U1" to "U6":

- ▶ Make sure to use transmitters and receivers from the same frequency range (see page 4 and the type plates of the devices).



To ensure that the desired frequencies are intermodulation-free:

- ▶ Contact your Sennheiser partner (see www.sennheiser.com).
-

- ▶ Set each transmitter to the same frequency bank.
 - ▶ On one of the transmitters, select a channel within this frequency bank (see page 25).
 - ▶ Assign this channel one of the calculated transmission frequencies (see page 25).
 - ▶ Synchronize a receiver with your transmitter (**sync**, see page 16).
- OR
- ▶ Manually set the receiver to the same frequency bank, channel and frequency that you set on the transmitter.
 - ▶ Repeat for the remaining transmitters and receivers as described above.

Cleaning the transmitter

CAUTION!



Liquids can damage the electronics of the transmitter!

Liquids entering the housing of the transmitter can cause a short-circuit and damage the electronics.

- ▶ Keep all liquids away from the transmitter.
 - ▶ Do not use any solvents or cleansing agents.
-
- ▶ Before cleaning, disconnect the transmitter from the mains.
 - ▶ Use a cloth to clean the transmitter from time to time.

Recommendations and tips

... for optimum reception

- Transmission range depends to a large extent on location and can vary from about 10 m to about 150 m. There should be a "free line of sight" between transmitting and receiving antennas.
- To avoid overloading the receiver, observe a minimum distance of 5 m between transmitting and receiving antennas.

... for multi-channel operation

- Each of the frequency banks "1" to "20" accommodates factory-preset receiving frequencies which are intermodulation-free. For possible frequency combinations, please refer to the supplied frequency information sheet.
- The channels in the frequency banks "U1" to "U6" can be assigned freely selectable frequencies (see page 31).
- When using several transmitters simultaneously, interference can be avoided by maintaining a minimum distance of 20 cm between two transmitters.
- Use accessories recommended by Sennheiser for multi-channel applications (see page 34).

Accessories

Cat. No. **Accessory**

- 004368** GA 3030 AM antenna front mount kit
- 502048** AC 3200 antenna combiner
- 500887** A 5000 CP circularly polarized broadband antenna
- 003658** A 2003 directional broadband antenna
- 004645** A 1031 omni-directional broadband antenna
- 087969** Antenna daisy-chain cable, 50 Ω , BNC, 0.25 m
- 002324** GZL 1019-A1 coaxial cable, type RG 58, BNC to BNC, 1 mm

If a problem occurs ...

Problem	Possible cause	Possible solution
Transmitter cannot be operated, "Locked" appears on the display panel	Lock mode is activated	Deactivate the lock mode (see page 14).
No operation indication	No mains connection	Check the connections of the mains cable.
No RF signal at the receiver	Transmitter and receiver are not on the same channel	Synchronize the transmitter with the receiver (see page 15).
	If "RF Mute" additionally appears on the transmitter display: RF signal is deactivated	Activate the RF signal (see page 14).
Very weak RF signal at the receiver	Transmission range is exceeded	Reduce the distance between receiver and transmitter.
		Reposition the antennas.
		Increase the transmission power (see page 19).
		Reduce the squelch threshold (see the instruction manual of the receiver).
RF signal available, no audio signal at the receiver	No input signal at the transmitter	Check the audio level on the transmitter display (see page 7)
	Very low input signal	Check the audio level on the transmitter display (see page 7), increase the level of the input signal or adjust the input sensitivity (see page 19).
Audio signal has a high level of background noise	Transmitter sensitivity is adjusted too low	Adjust the transmitter sensitivity correctly (see page 19).
Audio signal is distorted	If "AF PEAK" additionally appears on the transmitter display: transmitter sensitivity is adjusted too high	Adjust the transmitter sensitivity correctly (see page 19).
	Receiver's audio output level is adjusted too high	Reduce the audio output level of the receiver.

If a problem occurs that is not listed in the above table or if the problem cannot be solved with the proposed solutions, please contact your local Sennheiser partner for assistance.

To find a Sennheiser partner in your country, search at www.sennheiser.com under "Service & Support".

Specifications

RF characteristics

Frequency ranges	516–558, 558–626, 626–698, 718–790, 790–865 MHz (Aw to Dw, Gw, see page 4)
Transmission frequencies	up to 3,000 frequencies, tuneable in steps of 25 kHz 20 frequency banks, each with up to 32 factory-preset channels 6 frequency banks, each with up to 32 user programmable channels
Switching bandwidth	up to 75 MHz
Frequency stability	±10 ppm (–10 °C to +55 °C)
Antenna output	BNC socket, 50 Ω
RF output power at 50 Ω	typ. 10/30/50 mW (Low/Standard/High), switchable

AF characteristics

Modulation	wideband FM stereo (MPX pilot tone)
Compander system	Sennheiser HDX
Nominal/peak deviation	±24 kHz/±48 kHz
MPX pilot tone (frequency/deviation)	19 kHz/±5 kHz
AF frequency response	25 Hz to 15 kHz
AF input BAL AF IN L (I)/BAL AF IN R (II)	2 x XLR-3/¼" (6.3 mm) jack combo socket, electronically balanced
Max. input level	+22 dBu
THD (at 1 kHz and nominal deviation)	< 0.9 %
Signal-to-noise ratio at nominal load and peak deviation	> 90 dB
AF output LOOP OUT BAL L (I)/LOOP OUT BAL R (II)	¼" (6.3 mm) stereo jack socket, balanced

Overall device

Temperature range	–10 °C to + 55 °C
Power supply	100–240 V~
Current consumption	SR 2000: 0.1 A SR 2050: 0.2 A
Dimensions	approx. 217 x 483 x 43 mm
Weight	SR 2000: approx. 2500 g SR 2050: approx. 2700 g



In compliance with

Europe		EMC	EN 301489-1/-9
		Radio	EN 300422-1/-2, EN 300454-1/-2
		Safety	EN 60065

Approved by

Canada	Industry Canada	RSS 123 IC: 2099A-SR2000 and IC: 2099A-SR2050 limited to 806 MHz
USA	FCC-Part 74	FCC-ID: DMOSR2000 and DMOSR2050 limited to 698 MHz

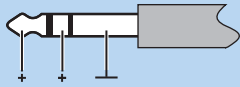
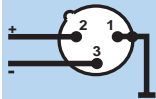
Connector assignment

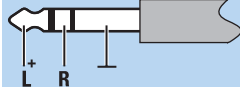
Audio	
<p>1/4" (6.3 mm) stereo jack plug, balanced (BAL AF IN/LOOP OUT)</p> 	<p>XLR-3F connector, balanced (BAL AF IN)</p> 
<p>1/4" (6.3 mm) mono jack plug, unbalanced (BAL AF IN/LOOP OUT)</p> 	<p>1/4" (6.3 mm) stereo jack plug for headphone output</p> 

Manufacturer Declarations

Warranty

Sennheiser electronic GmbH & Co. KG gives a warranty of 24 months on this product.

For the current warranty conditions, please visit our website at www.sennheiser.com or contact your Sennheiser partner.

In compliance with the following requirements

- RoHS Directive (2002/95/EC)
- WEEE Directive (2002/96/EC)



Please dispose of the transmitter at the end of its operational lifetime by taking it to your local collection point or recycling center for such equipment.

CE Declaration of Conformity

- **CE 0682** 
- R&TTE Directive (1999/5/EC), Low Voltage Directive (2006/95/EC)

The declarations are available at www.sennheiser.com.

Before putting the device into operation, please observe the respective country-specific regulations.

Statements regarding FCC and Industry Canada

This device complies with Part 15 of the FCC Rules and with RSS-210 of Industry Canada. Operation is subject to the following two conditions: (1) this device may not cause harmful interference, and (2) this device must accept any interference received, including interference that may cause undesired operation.

This equipment has been tested and found to comply with the limits for a Class B digital device, pursuant to Part 15 of the FCC Rules. These limits are designed to provide reasonable protection against harmful interference in a residential installation. This equipment generates, uses and can radiate radio frequency energy and, if not installed and used in accordance with the instructions, may cause harmful interference to radio communications. However, there is no guarantee that interference will not occur in a particular installation. If this equipment does cause harmful interference to radio or television reception, which can be determined by turning the equipment off and on, the user is encouraged to try to correct the interference by one or more of the following measures:

- Reorient or relocate the receiving antenna.
- Increase the separation between the equipment and receiver.
- Connect the equipment into an outlet on a circuit different from that to which the receiver is connected.
- Consult the dealer or an experienced radio/TV technician for help.

This class B digital device complies with the Canadian ICES-003.

Changes or modifications made to this equipment not expressly approved by Sennheiser electronic Corp. may void the FCC authorization to operate this equipment.

Before putting the device into operation, please observe the respective country-specific regulations!

Index

activating/deactivating

- AF Peak (warning message) 28
- lock mode (Auto Lock) 25
- RF Mute (warning message) 28
- warning messages (Warnings) 28

adjusting

- contrast (LCD Contrast) 28
- input sensitivity (Sensitivity) 22
- network configuration (IP Address) 29
- receiver parameters (Sync Settings) 27
- transmission power (RF Power) 28

Advanced Menu (extended menu)

- overview 19
- settings 25

AF Peak (warning message) 19

antenna

- connecting a remote antenna 9
- connecting the AC 3200 antenna combiner 9
- connecting the rod antenna to the rear 9
- mounting the rod antenna to the front 9

antenna front mount kit 9

audio signal

- daisy chaining 11
- monitoring 15

audio source, connecting 11

Auto Lock (activating/deactivating the lock mode) 25

channel

- assigning a frequency 26
- display 7
- overview 4
- selecting (Easy Setup) 30
- selecting (Frequency Preset) 23
- selecting (Tune) 25

connecting

- audio source 11
- mains cable 12
- mixing console 11
- remote antenna 9
- transmitters in a network 12

displays

- adjusting the contrast of the display panel (LCD Contrast) 28
- AF (audio level) 7
- AF PEAK (overmodulation) 7
- frequency 7
- input sensitivity 7

overview 7

- PEAK (overmodulation) 7
- transmission icon 7
- transmission power 7

Easy Setup Sync 15, 16, 30

equalizer

- display of equalizer setting 7
- setting 24

extended menu (Advanced Menu)

- overview 19
- settings 25

factory default settings (resetting the settings made in the operating menu) 28

frequency

- ~ ranges 4
- important notes on frequency selection 30
- preset frequencies 4
- selecting ~ presets 23
- setting a transmission frequency 25
- using freely selectable transmission frequencies 31

frequency bank

- ~ system 4
- display 7
- overview 4
- selecting (Easy Setup) 30
- selecting (Frequency Preset) 23

Frequency Preset (selecting a frequency bank/channel) 23

infra-red transmission 15

IP-Address (adjusting the network configuration) 29

LCD Contrast (contrast of the display panel) 28

lock mode

- activating/deactivating (Auto Lock) 25

Locked (lock mode activated) 14

main menu (Menu)

- overview 19
- settings 22

Menu (main menu)

- overview 19
- settings 22

Mode (mono/stereo selection) 22

modulation (input sensitivity/adjusting the sensitivity) 22

- mono operation 6, 23
- multi-channel operation 30
- multi-channel system 30
- Name (entering a name) 24
- network configuration, adjusting 29
- offline operation (RF signal deactivated) 13
- online operation (RF signal activated) 13
- operating menu
 - overview 18
 - using 20
- receiver, synchronizing with transmitter 15, 30
- Reset (resetting the settings made in the operating menu) 28
- RF Mute (warning message) 13, 15, 19, 35
- RF Mute Off (activating the RF signal) 13, 15
- RF Mute On (deactivating the RF signal) 13, 14
- RF signal
 - activating 13
 - deactivating on switch-on 13
- selecting
 - channel (Frequency Preset) 23
 - frequency bank (Frequency Preset) 23
 - mono or stereo operation (Mode) 22
- Sensitivity (adjusting the input sensitivity) 22
- Software Revision (displaying the software revision) 29
- standby 14
- Sync 15, 16, 30
- Sync Settings (adjusting transferable receiver settings) 27
- synchronizing (transmitter/receiver) 15, 30
- transmission frequency
 - selecting (Frequency Preset) 23, 25
 - setting (Tune) 25
- transmission power, optimizing 33
- transmission link 30
- transmitter
 - cleaning 32
 - fitting the device feet 8
 - mounting into a 19" rack 8
 - setting up on a flat surface 8
 - switching off 13, 14
 - switching on 13
 - switching to standby 13
 - synchronizing with receiver 15, 30
- troubleshooting 35
- Tune (setting the transmission frequencies and frequency banks) 25
- Unlock (deactivating the lock mode) 14
- using
 - equalizer 24
 - operating menu 20
- Warnings (warning messages)
 - activating/deactivating 28
 - overview 19
- WSM (Wireless Systems Manager) 12, 30

Sennheiser electronic GmbH & Co. KG
Am Labor 1, 30900 Wedemark, Germany
www.sennheiser.com

Printed in Germany
Publ. 01/09
529682/A01

Free Manuals Download Website

<http://myh66.com>

<http://usermanuals.us>

<http://www.somanuals.com>

<http://www.4manuals.cc>

<http://www.manual-lib.com>

<http://www.404manual.com>

<http://www.luxmanual.com>

<http://aubethermostatmanual.com>

Golf course search by state

<http://golfingnear.com>

Email search by domain

<http://emailbydomain.com>

Auto manuals search

<http://auto.somanuals.com>

TV manuals search

<http://tv.somanuals.com>