

Wireless TV Listening System Set 840 S

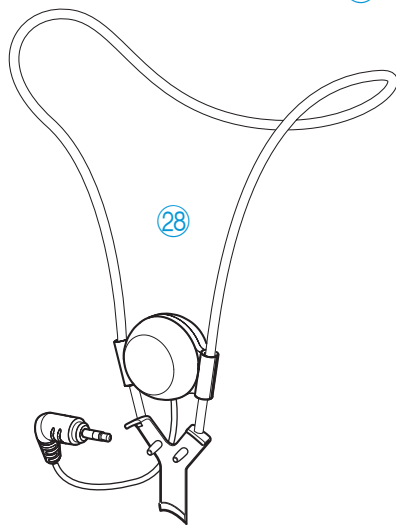

Instruction manual

I

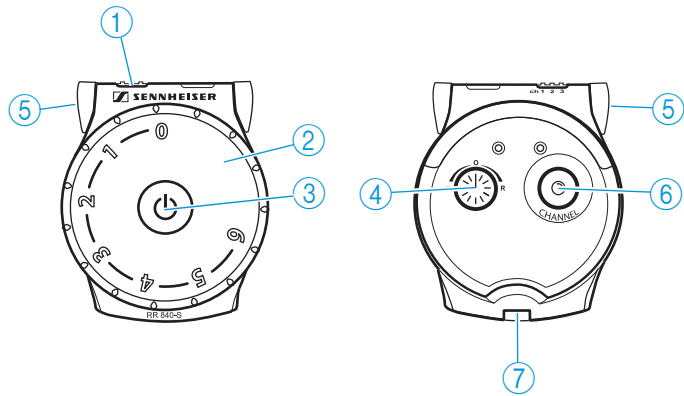

II

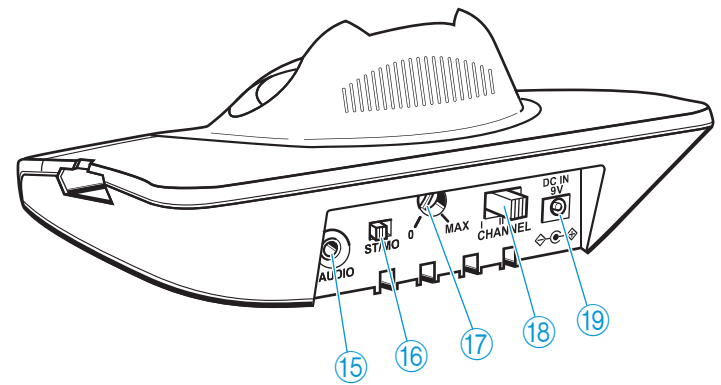
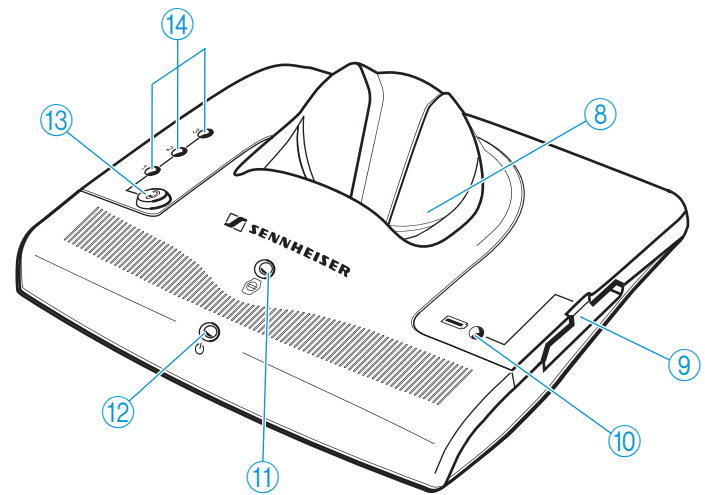

Contents

Safety instructions	2
Delivery includes	4
Product overview	5
Putting the Set 840 S system into operation	6
Setting up the transmitter	6
Connecting the transmitter to a sound source	7
Connecting the transmitter to the mains	11
Connecting the induction loop or headphones for hearing aids to the receiver	12
Wearing the receiver	13
Using the Set 840 S system	15
Switching the transmitter on/off	15
Switching the receiver on/off	16
Adjusting the volume	16
Searching for a sound source	17
Changing the transmission channel	17
Adjusting the balance	18
Switching between mono and stereo operation	18
Individually enhancing the speech intelligibility	19
Storing and charging the receiver	20
Charging a rechargeable battery in the transmitter's charging compartment	21
What if	22
... this indicator lights up?	22
... you press this button?	23
... you change the position of this control/switch?	23
... you hear acoustic signals or warning signals?	24
Cleaning the Set 840 S system	25
Cleaning the transmitter and the receiver	25
If a problem occurs	26
Additional technical information	28
Accessories and spare parts	30
Specifications	32
Manufacturer Declarations	34
Index	36

Safety instructions

- Please read this instruction manual carefully and completely before using the products.
- Make this instruction manual easily accessible to all users at all times. Always include this instruction manual when passing the products on to third parties.
- Do not use the products in situations which require special attention (e.g. when performing skilled jobs).
- Always keep the products dry and do not expose them to extreme temperatures.
- Use the products with care and set them up in a clean, dust-free environment.
- Varnish or furniture polish may degrade the feet of the transmitter, which could stain your furniture. You should therefore place the transmitter on a non-slip pad to avoid potential staining of furniture.
- Always maintain a distance of at least 3.94" (10 cm) between the ear cups and the cardiac pacemaker or implanted defibrillator since the product generates permanent magnetic fields.
- This stethoset receiver allows you to set higher volumes than conventional headphones. This can cause hearing damage in persons with healthy hearing and especially in children.
- Refer all servicing to qualified service personnel. Servicing is required when the apparatus has been damaged in any way, such as power supply cord or plug is damaged, liquid has been spilled or objects have fallen into the apparatus, when the apparatus has been exposed to rain or moisture, does not operate normally, or has been dropped.
- **WARNING:** To reduce the risk of fire or electric shock, do not expose the products to rain or moisture.
- Use only the supplied mains unit.
- Disconnect the mains connector from the wall socket
 - to completely disconnect the products from the mains,
 - during lightning storms or when unused for long periods of time.
- Ensure that the mains unit is
 - always readily operable and easily accessible,
 - properly plugged into the wall socket,
 - not covered or exposed to direct sunlight for longer periods of time in order to prevent heat accumulation,
 - only operated within the permissible temperature range (see "Specifications" on page 32),
 - not operated near heat sources.

Intended use

Intended use includes

- having read this instruction manual, especially the chapter “Safety instructions” on page 2,
- using the products within the operating conditions and limitations described in this instruction manual.

“Improper use” means using the products other than as described in this instruction manual, or under operating conditions which differ from those described herein.











Safety instructions for the Lithium-Polymer rechargeable battery

The BA 300 is a Lithium-Polymer rechargeable battery. If abused or misused, this rechargeable battery may be damaged. Please understand that Sennheiser does not accept liability for damage arising from abuse or misuse.

WARNING! In extreme cases, the rechargeable battery may even present a



- heat hazard,
- fire hazard,
- explosion hazard,
- smoke and gas hazard.

	Only charge rechargeable batteries with the appropriate Sennheiser chargers.		Do not heat above 70°C/ 158°F, e.g. do not expose to sunlight or throw into a fire.
	Return defective devices or exhausted rechargeable batteries to your specialist dealer.		When not using the rechargeable battery for extended periods of time, charge it regularly (every 6 months for about 1 hour).
	Do not short-circuit.		Only charge rechargeable batteries at ambient temperatures between 10°C/50°F and 40°C/104°F.
	Do not mutilate or dismantle.		Do not charge the rechargeable battery if the device is obviously defective.
	Store the devices/ rechargeable batteries in a cool and dry place at room temperature.		Do not expose to moisture.

Delivery includes

The Set 840 S system is available as an EU and a US version. The following table shows which items are included with the respective version.

Components of the Set 840 S system		EU	US
1	RR 840 S receiver with BA 300 Lithium-Polymer rechargeable battery	✓	
1	TR 840 transmitter with integrated charging compartments	✓	
1	NT 9-3AW mains unit with 2 country adapters (EU, UK)	✓	
	1 country adapter (US)		✓
1	connection cable with two 3.5 mm stereo jack plugs for connection to a headphone socket	✓	
1	audio adapter (3.5 mm to 1/4" (6.3 mm) jack plug)	✓	
1	audio adapter for RCA socket (e.g. TB/Aux-Out)	✓	
1	audio adapter for SCART socket	✓	
1	MKE 800 TV-N microphone		✓
1	EZT 3011 induction loop	✓	
1	lanyard	✓	
1	clip for attaching the receiver	✓	
1	instruction manual	✓	
1	installation manual	✓	





Product overview

The overview pictures of the receiver and the transmitter can be found on the inside front cover of this instruction manual.

I Receiver

- ① Channel indicator
- ② Volume control
- ③ On/off button 
- ④ Balance control
- ⑤ Socket for headphones, induction loop or connection cable to hearing aid
- ⑥ Channel search button
- ⑦ Battery compartment
- ⑧ Induction loop

II Transmitter

- ⑧ Charging compartment for receiver
- ⑨ Charging compartment for optional spare rechargeable battery
- ⑩ Charging indicator for optional spare rechargeable battery 
- ⑪ Charging indicator for receiver's rechargeable battery 
- ⑫ Operation indicator 
- ⑬ "Speech intelligibility" button 
- ⑭ Indicator for the selected speech intelligibility
- ⑮ Socket (marked blue) for connection of sound source or external microphone
- ⑯ ST/MO slide switch (stereo/mono)
- ⑰ Treble adjustment control
- ⑱ Channel selector switch
- ⑲ DC socket (marked yellow) for connection of mains unit

Putting the Set 840 S system into operation

Setting up the transmitter

- ▶ Choose a suitable place near your sound source (e.g. TV).
- ▶ Do not place the transmitter close to metal objects such as shelf bars, reinforced concrete walls, etc. as this can decrease the transmitter's range.

It is not necessary that the transmitter and receiver are in the same room, so you can move around freely in the home or outside in the garden.

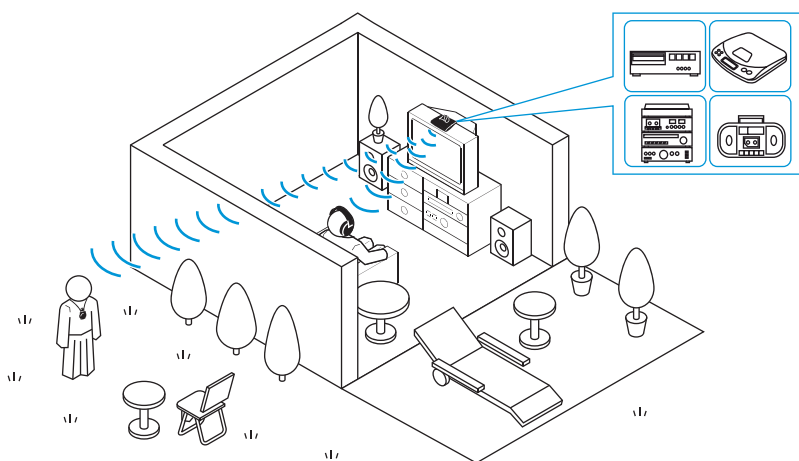

When the receiver leaves the range of the transmitter, it produces warning signals and then automatically switches off after 3 minutes.



i One transmitter can be used to transmit to several receivers on the same frequency.

Connecting the transmitter to a sound source

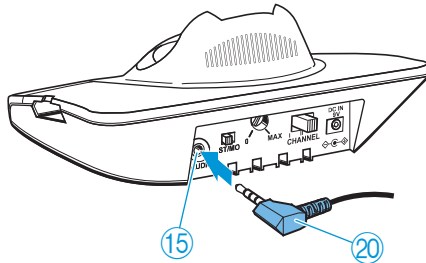
- ▶ Switch your sound source (e.g. TV) off before connecting the transmitter.



- ▶ Plug one end of the connection cable ⑳ into the blue socket ⑮ of the transmitter.
- ▶ Check the available connection possibilities of your sound source (e.g. TV):

Connection possibility	Name of connection possibility
A 	Headphone socket
B 	RCA socket
C 	SCART socket (SCART adapter included with the EU version)

What if your sound source doesn't have any of these connection possibilities?

D 	MKE 800 TV-N external microphone (included with the US version)
--	--

- ▶ Connect the transmitter as described in the corresponding chapter **A**, **B**, **C** or **D**.

i If possible, use the SCART connection **C**.

SCART adapter and microphone are also available as accessories (see page 30).

A Connecting the transmitter to a headphone socket

- ▶ Plug the other end of the connection cable (20) into the headphone socket on your sound source.

Is the plug on the connection cable too small for the headphone socket?

- ▶ Plug the adapter to 1/4" (6.3 mm) jack socket (21) onto the connection cable (20).
- ▶ Adjust the volume of the headphone socket on your sound source to a medium level. This improves the quality of wireless sound transmission. For detailed information, please refer to the instruction manual of your sound source (e.g. TV).

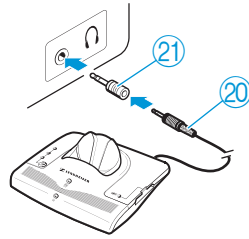

i With most TVs, the headphone socket is located at the front or sides.

B Connecting the transmitter to an RCA socket

- ▶ Plug the audio adapter for RCA socket (22) onto the connection cable (20).
- ▶ Connect the red connector of the audio adapter (22) to the red RCA socket R of your sound source.
- ▶ Connect the white connector of the audio adapter (22) to the white or black RCA socket L of your sound source.

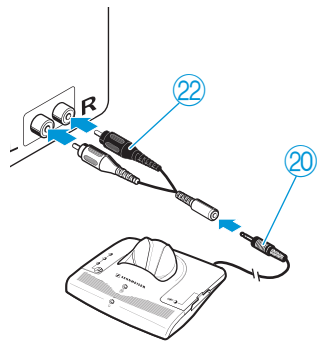

i With most TVs, the RCA socket is located at the rear. If your TV has several RCA sockets, use the socket **RCA output**.

C Connecting the transmitter to a SCART socket

- ▶ Plug the SCART adapter (23) onto the connection cable (20).
- ▶ Connect the SCART adapter (23) to the SCART socket on your TV.

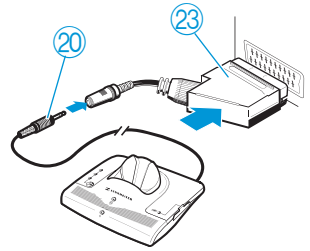

i If your TV has several SCART sockets, use the socket **SCART output**.

D Using the MKE 800 TV-N external microphone

What if your sound source doesn't have any of the connections mentioned above? You can then use the optional MKE 800 TV-N microphone.

What if your sound source mutes the external loudspeakers if you use one of the connections mentioned above?

- ▶ Via the operating menu of your TV, check if the muting can be deactivated.
- ▶ If the muting persists, use the optional MKE 800 TV-N microphone instead of the connection cable.

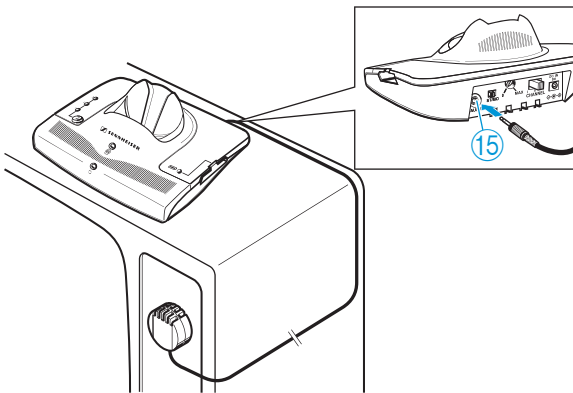

To connect the MKE 800 TV-N microphone:

- ▶ If possible, adhere the supplied Velcro tape directly in front of the loudspeaker of your TV.
- ▶ Press the microphone onto the Velcro tape.
- ▶ Connect the jack plug of the microphone to the blue socket ⑮ of the transmitter.



You can change the sound by varying the position of the microphone in front of the loudspeaker.

Connecting the transmitter to the mains

The EU and UK country adapters are included with the EU version of the Set 840 S; the US country adapter is included with the US version of the Set 840 S.

- ▶ Slide the supplied country adapter ②⑤ onto the mains unit ②④.
- ▶ Connect the yellow connector of the mains unit to the yellow socket ①⑨ of the transmitter.
- ▶ Plug the mains unit ②④ into a wall socket.
The operation indicator ①②  on the transmitter lights up green.

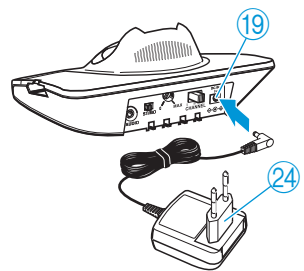
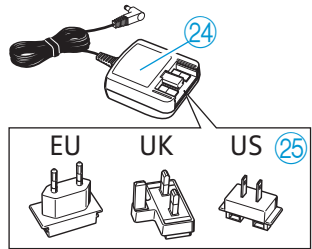

When connecting the transmitter to the mains for the first time, charge the rechargeable battery for 3 hours as described in the chapter "Storing and charging the receiver" on page 20.



If there is no audio signal from the sound source for about 3 minutes, the transmitter automatically switches off. The operation indicator ①②  goes off.

To disconnect the transmitter from the mains, pull out the mains connector from the wall socket.

When not using the transmitter for extended periods of time (e.g. when you are on holiday), pull out the mains connector from the wall socket. In this case, however, the receiver's rechargeable battery will not be recharged.

Connecting the induction loop or headphones for hearing aids to the receiver

The socket ⑤ of the receiver allows you to connect

- the supplied induction loop ⑳,
- headphones or
- a connection cable to your hearing aid or to induction couplers.

Connecting the induction loop

- ▶ Carefully remove the clip ㉑ from the receiver.
- ▶ Attach the clip of the induction loop as shown.

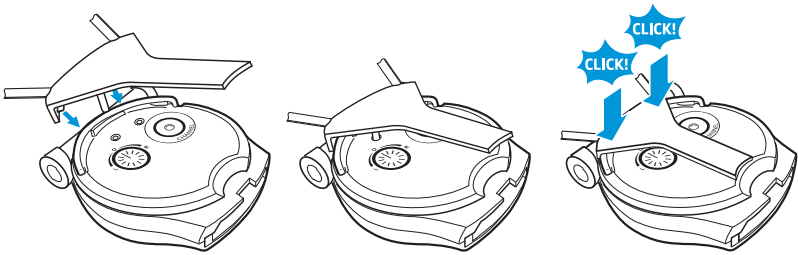

- ▶ Connect the induction loop ㉒ to the socket ⑤ of the receiver.

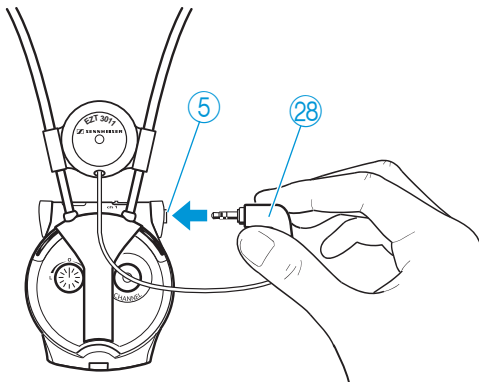

- ▶ Set your hearing aid to position "T".

If your hearing aid has no position "T", please contact your hearing aid acoustician.



For alternative connection possibilities to your hearing aid as well as the connection to cochlea implants, please contact your hearing aid acoustician.

Connecting headphones

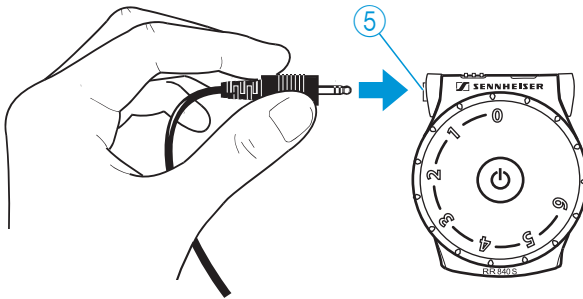

- ▶ Connect the 3.5 mm jack plug of the headphones to the socket ⑤ of the receiver.

Wearing the receiver

In order to wear the receiver, you can use the supplied lanyard ⑲, the clip ⑳ or the supplied induction loop ㉔. The induction loop is suitable for users of hearing aids, the lanyard and the clip are useful if you are using headphones.

Wearing the receiver around the neck

If you want to wear the receiver around your neck, use

- the supplied lanyard ⑲ or
- the connected induction loop ㉔ (where applies).

To attach the lanyard ⑲:

- ▶ Connect the fasteners of the lanyard ⑲ to the metal ring at the rear of the receiver.

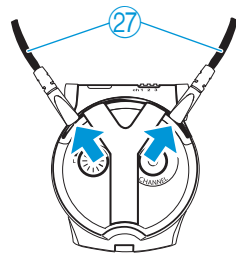

- ▶ Wear the receiver around your neck, with the Sennheiser logo facing away from your body.

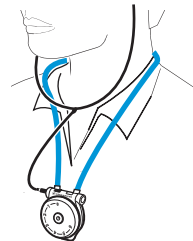

Attaching the receiver to clothing or belt

If you want to attach the receiver to your clothing or belt, use the attachment clip 26.

To attach the receiver:

- ▶ Attach the clip 26 to your clothing or belt.

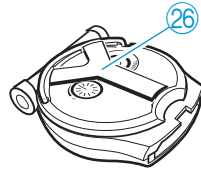

To remove the receiver:

- ▶ Pull the clip 26 with the receiver away from your clothing or belt.

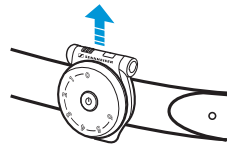

Using the Set 840 S system

To switch the Set 840 S system on, proceed as follows:

Sequence of steps	Page
1. Switch your sound source (e.g. TV) on.	15
2. Adjust the volume on the receiver to a low level.	16
3. Switch the receiver on.	16
4. Adjust the desired volume on the receiver.	16
5. If necessary, set a different channel on the transmitter.	17

Switching the transmitter on/off

To switch the transmitter **on**:

- ▶ Switch your sound source on.
The transmitter automatically switches on. The operation indicator  lights up green.

If the transmitter doesn't switch on:

- ▶ Read the corresponding chapter on page 26.

To switch the transmitter **off**:

- ▶ Switch your sound source off.
The transmitter automatically switches off after 3 minutes. The operation indicator  goes off.

Switching the receiver on/off

CAUTION! Hearing damage due to high volumes!



This receiver allows you to set higher volumes than conventional devices. This can cause hearing damage in persons with healthy hearing and especially in children.

- ▶ Before using the receiver, set the volume on the receiver to a low level.
- ▶ Do not continuously expose yourself to high volumes.

To switch the receiver **on**:

- ▶ Keep the on/off button ③ pressed until the channel indicator ① lights up.

The channel indicator ① goes off after 30 seconds.

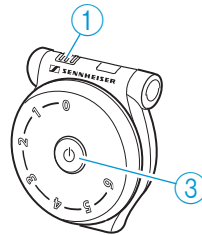

To switch the receiver **off**:

- ▶ Keep the on/off button ③ pressed until the channel indicator ① goes off.



If you are not within the range of the transmitter, the receiver automatically switches off after 3 minutes.

Adjusting the volume

- ▶ Use the volume control ② to adjust the volume to a sufficient and comfortable level.

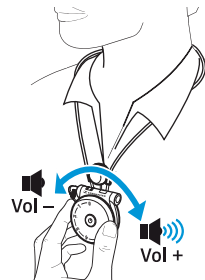

Searching for a sound source

- ▶ Switch the receiver on.

The receiver automatically searches for one of the 3 channels of the transmitter and starts the channel search on the last selected channel. If a channel is found, the channel search stops.

You hear the sound of the sound source found.

Depending on the channel found, the receiver produces 1, 2 or 3 beeps (see page 24) and the channel indicator ① on the receiver lights up as follows:



- i** The channel indicator ① goes off after 30 seconds so that the light won't disturb you in a dark room.

What if you don't hear the desired sound source?

The channel search has possibly found another sound source (e.g. from another nearby system).

To continue the channel search:

- ▶ Press the channel search button ⑥ on the receiver repeatedly until you have found your sound source.

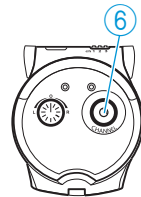

If you still cannot find your sound source:

- ▶ Change the transmission channel as described in the next chapter.
- ▶ Read the chapter "If a problem occurs ..." on page 26.

Changing the transmission channel

If several transmitters are operated simultaneously and are very close to one another, reception can be subject to interference (e.g. hissing noise).

- ▶ Change, if necessary several times, the position of the channel selector switch ⑱ on the transmitter to change to an interference-free channel. You can choose between 3 channels.

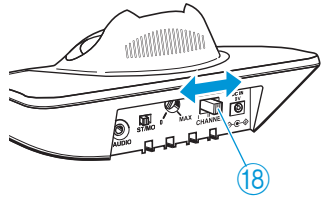

- ▶ Press the channel search button ⑥ on the receiver to re-start the channel search.

If reception is still subject to interference:

- ▶ Read the chapter "If a problem occurs ..." on page 26.

Adjusting the balance

The balance control allows for right/left volume adjustment. Adjust the balance so that you hear equally well with both ears.

- ▶ Turn the balance control ④ to the left L or right R in order to increase the volume for the corresponding ear.

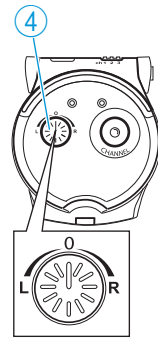



Switching between mono and stereo operation

If, despite a correct balance adjustment, you can hear the sound only with one ear:

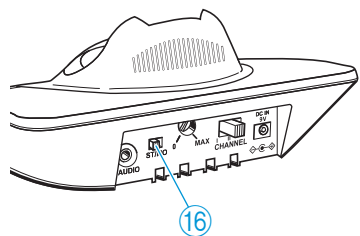
- ▶ Set the ST/MO switch ⑰ on the transmitter to MO (mono).

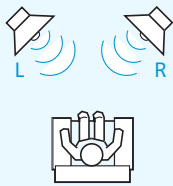

Meaning of the terms “mono” and “stereo”

Stereo (ST)	Mono (MO)
	
Example: L: Speech from the left R: Music from the right	
You hear speech from the left and music from the right.	You hear speech and music coming from the front.

Individually enhancing the speech intelligibility

The “speech intelligibility” button **13**  allows you to adjust the sound to your individual needs.

Try out which setting works best for you.

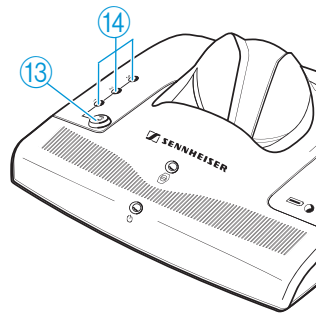

- ▶ Press the “speech intelligibility” button **13**  repeatedly until the sound is optimally adjusted to your needs.

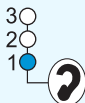
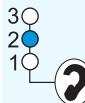
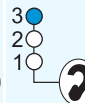
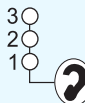
Press the button	1 x	2 x	3 x	4 x
Indicator 14 is lit yellow				
Setting	1	2	3	Default setting

If necessary, you can have the speech intelligibility fine adjusted to your hearing ability (see page 28).

Storing and charging the receiver

- ▶ After use, place the receiver into the transmitter's charging compartment ⑧ without exerting too much pressure. The receiver automatically switches off.

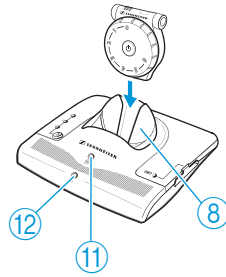

The Sennheiser logo can face the operation indicator ⑫  or away from it.

When the receiver is placed correctly into the charging compartment, the indicator ⑪ lights up:

-  red: The battery is being charged.
- green: The battery is fully charged.

 With a fully charged battery, the **operating time is up to 9 hours**.

The transmitter remains switched on during charging. If you have a second receiver, it can be used with the transmitter while the discharged first receiver is being charged.

Always store the receiver in the transmitter's charging compartment ⑧ to ensure that it is fully charged. The intelligent battery charging technology prevents overcharging.

Charging a rechargeable battery in the transmitter's charging compartment

You can charge the receiver's rechargeable battery or a spare BA 300 rechargeable battery (not included in the delivery of the Set 840 S) in the charging compartment ⑨ at the side of the transmitter.

The spare battery offers extended listening time while the discharged first battery is being recharged.



Before using the spare rechargeable battery for the first time, charge it for at least 3 hours.

Removing and charging the receiver's battery

To remove the receiver's battery:

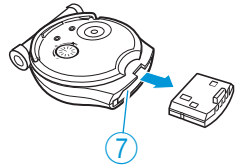

- ▶ Pull the battery out of the receiver's battery compartment ⑦.

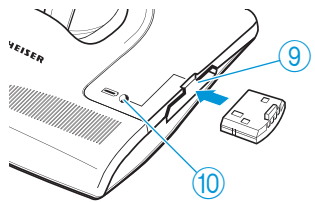

- ▶ Insert the receiver's battery into the charging compartment ⑨ at the side of the transmitter as shown.



When the battery is inserted correctly, the indicator ⑩ lights up:



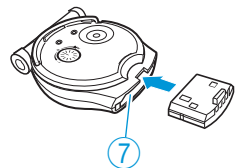

-  red: The battery is being charged.
The charging time is approx. 3 hours.
-  green: The battery is fully charged.

- ▶ Insert the battery into the receiver as shown.
- ▶ Slide the battery into the battery compartment ⑦ as far as it will go.



What if ...

... this indicator lights up?

Indicator	Status	Meaning
 Channel indicator ① on the receiver	lit yellow	The receiver has just been switched on or a button has just been pressed.
	flashes	The distance between receiver and transmitter is too great. The receiver switches off after 3 minutes.
	off	The receiver is switched on for more than 30 secs. and no button has been pressed. The receiver is switched off.
 Operation indicator ⑫ on the transmitter	lit green	The transmitter is switched on.
	off	The transmitter is switched off.
 Charging indicator ⑪	lit red	The rechargeable battery is being charged.
 Charging indicator ⑩	lit green	The rechargeable battery is fully charged.
3 ○ 2 ● 1 ○ "Speech intelligibility" indicator ⑭ on the transmitter	lit yellow	The speech intelligibility enhancement is switched on.
	off	The speech intelligibility enhancement is switched off.





... you press this button?



Button	Function	Page
Channel search button ⑥ on the receiver	Searches for the sound source or a different channel	17
“Speech intelligibility” button ⑬ ? on the transmitter	Selects one of the possible settings in order to individually enhance the speech intelligibility	19

... you change the position of this control/switch?

Control/switch	Function	Page
Volume control ② on the receiver	Reduces or increases the volume of the receiver	16
Balance control ④ on the receiver	Increases the volume for the left or the right ear	18
Channel selector switch ⑱ on the transmitter	Selects a different transmission channel	17
ST/MO switch ⑯ on the transmitter	Sets the transmitter to mono or stereo operation	18
Treble adjustment control ⑰ on the transmitter	Treble adjustment is only to be made by a hearing aid technician / an expert	28

... you hear acoustic signals or warning signals?

Acoustic signal	Meaning
	3 ascending beeps The receiver has just been switched on.
	3 descending beeps The receiver has just been switched off.
	1 acknowledgement beep The channel search button has been pressed once briefly. The channel search button has been pressed for 5 seconds.
	1–3 short beeps The receiver is set to channel 1, 2 or 3.

Warning signal	Meaning
	6 short beeps The receiver does not receive any signal from the transmitter: <ul style="list-style-type: none"> • The distance between transmitter and receiver is too great. The receiver switches off after 3 minutes. • The transmitter is switched off.
	2 long beeps The rechargeable battery is almost flat.

To switch the acoustic signals on and off:

- ▶ Press the channel search button ⑥ on the receiver for approx. 5 seconds.

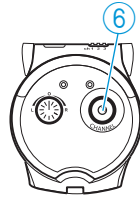

You hear a short acoustic signal.



Warning signals cannot be switched off.

Cleaning the Set 840 S system

Cleaning the transmitter and the receiver

CAUTION! Danger of electric shock and damage to the device electronics!

Liquids entering the housing of the devices can cause a short-circuit and damage the electronics.

- ▶ Keep all liquids far away from the devices.
 - ▶ Do not use any cleansing agents or solvents.
-
- ▶ Before cleaning, disconnect the transmitter from the mains.
 - ▶ Use only a slightly damp cloth to clean the devices.

If a problem occurs ...

The transmitter does not switch on

Possible cause	Solution
Is the mains unit connected correctly?	Check the connection of the mains unit to the transmitter and to the mains (see page 11).
Is the sound source switched on?	Switch your sound source on.
Is the volume of the sound source sufficient?	Set the volume on your sound source to a medium level.

You cannot hear anything

Possible cause	Solution
Is the transmitter placed close to metal objects?	Choose a different place for the transmitter. Make sure that the transmitter is not placed close to metal objects.
Are all connectors connected correctly?	Check the connection between the transmitter and your sound source (see page 7).
Is the operation indicator ⑫ lit?	Check if the transmitter is switched on (see page 15).
Is the volume of the sound source sufficient?	Set the volume on your sound source to a medium level.
Is the volume of the receiver sufficient?	Increase the volume by turning the volume control ② (see page 16).
Is the rechargeable battery inserted properly into the receiver and fully charged?	Remove the rechargeable battery and reinsert it into the receiver. If this doesn't help: recharge the rechargeable battery (see page 20).

You hear the sound only with one ear

Possible cause	Solution
Is the balance adjusted correctly?	Turn the balance control ④ to the left or right (see page 18).
Is the transmitter set to mono?	Set the ST/MO switch ⑩ on the transmitter to mono (MO) (see page 18).

The sound of your sound source is hardly intelligible

Possible cause	Solution
Is the speech intelligibility enhancement out of adjustment?	Press the "speech intelligibility" button ⑬  on the transmitter repeatedly until the sound is optimally adjusted to your needs (see page 19).
Is there another transmitter operating in the proximity?	Change the transmission channel (see page 17).
Is the receiver still within the transmitter's range?	Move the receiver closer to the transmitter.

The loudspeakers of your TV are muted

Possible cause	Solution
Some TVs have a function that mutes the loudspeakers when you connect a transmitter	Via the operating menu of your TV, check if and how the muting can be deactivated.
	Use a different audio socket on your TV or use the MKE 800 TV-N external microphone.



If a problem occurs that is not listed in the above tables or if the problem cannot be solved with the proposed solutions, please contact your Sennheiser partner for assistance.

Additional technical information

Fine adjusting the speech intelligibility

The speech intelligibility can be enhanced individually on the transmitter (see page 19).

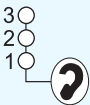
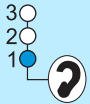
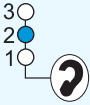
There are the following settings:

Setting	Indicator ⁽¹⁴⁾ lit yellow	Fine adjustment
Default setting		No fine adjustment made
1		Compression
2		Treble boost
3		Compression and treble boost

Compression (settings 1 and 3)

Deterioration of the ability to hear quiet sounds as well as loud ones is a typical symptom of old age. Compression compensates for these volume differences by boosting the volume of quiet sounds and reducing the volume of loud sounds if necessary.

Compression seems to put the speech in the foreground, making it easier to understand.

Compression is self-regulating; once it has been activated, it is not necessary to make any other settings.

Treble boost (settings 2 and 3)

Another typical age-related phenomenon is the deterioration of the hearing with regard to high frequencies. However, high frequencies are important for the intelligibility of speech.

The treble boost makes the speech clearer and easier to understand.

With the treble boost (settings 2 and 3), additional fine adjustment is possible using the treble boost control ⁽¹⁷⁾ at the rear of the transmitter.

- ▶ Use a screwdriver to turn the treble boost control ⑰ to the left or right until the sound can be heard very well.

The position "0" corresponds to a minimum boost, the position "MAX" corresponds to a maximum boost, and the control is factory-preset to the medium position.

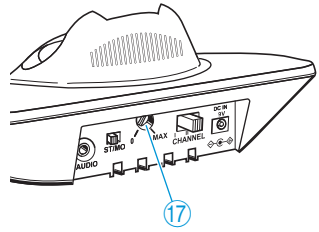

Function of the treble boost control

By means of the transmitter's steplessly adjustable treble boost control ⑰, the audio signal is boosted as shown in the diagram. The treble boost control ⑰ allows you to select one of the curves shown in the diagram below.

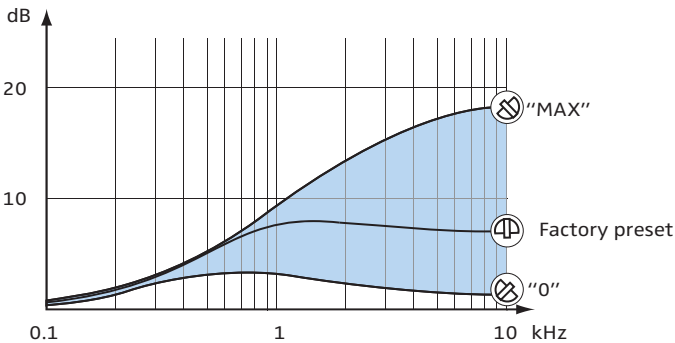

Accessories and spare parts

CAUTION! Danger of damage to the device!

Components from other manufacturers (e.g. for power supply or rechargeable battery) may cause damage to the device and will invalidate the warranty.

- ▶ Use only original Sennheiser accessories and spare parts.
-

For the Set 840 S, the following receivers and stethoset receivers are available from your specialist dealer:

Cat. No. **Accessory/spare part**

EU version

502026 RR 840 S receiver

502025 RR 840 stethoset receiver

US version

502014 RR 840 S receiver

502027 RR 840 stethoset receiver

The following Set 840 S accessories are available from your specialist dealer:

Cat. No.	Accessory/spare part
500898	BA 300 spare rechargeable battery
502566	EZT 3011 induction loop
504061	EZT 3012 induction loop
003448	EZI 120 induction couplers
528185	Lanyard
528184	Clip for attaching the receiver
517627	Extension cable, 3 m (3.5 stereo jack plug)
500974	MKE 800 TV-N external microphone (mono)
502710	L 300 10-10 charger
	HZL connection cables
001676	HZL 30-6 (3.5 mm jack plug to 1 mini-plug, 40 cm)
004658	HZL 30-600 (3.5 mm jack plug to 1 mini-plug, 60 cm)
001678	HZL 32-6 (3.5 mm jack plug to 2 mini-plugs, 40 cm)
004657	HZL 32-600 (3.5 mm jack plug to 2 mini-plugs, 60 cm)
002408	HZL 34-6E (3.5 mm jack plug to 1 Euro plug, 40 cm)
004652	HZL 34-600E (3.5 mm jack plug to 1 Euro plug, 60 cm)
002409	HZL 36-6E (3.5 mm jack plug to 2 Euro plugs, 40 cm)
004653	HZL 36-600E (3.5 mm jack plug to 2 Euro plugs, 60 cm)

Specifications

System

Modulation	FM, stereo
Carrier frequencies	
EU version	863.3/864.0/864.7 MHz
US version	925.95/926.8/927.5 MHz
Frequency response	50 Hz–16,000 Hz
THD	< 1%
Charging time for rechargeable battery	approx. 3 hours
Signal-to-noise ratio (1 mV, peak deviation)	typ. 70 dB (A)
Operating temperature	10°C to 40°C

Transmitter

RF radiated power	
EU version	max. 10 mW (EIRP)
US version	max. 50 mV/m (at a distance of 3 m)
Range	
EU version	up to 100 m
US version	up to 100 ft
Audio/microphone connection	3.5 mm stereo jack socket
Power supply	9 V
Max. power consumption (transmitter in conjunction with the NT 9-3AW mains unit)	2.4 W (incl. battery and receiver charging and with switched-on transmitter)
Max. current consumption	
EU version	80 mA (w/o battery charging)
US version	70 mA (w/o battery charging)
Standby consumption	approx. 0.5 W (w/o battery charging)
Weight	approx. 260 g
Dimensions	approx. 112 x 146 x 58 mm

Receiver

Audio connection	3.5 mm stereo jack socket
Power supply	via BA 300 rechargeable Li-Pol battery (3.7 V / 150 mAh)
Operating time	up to 9 hours
Weight	approx. 50 g (with BA 300)
Dimensions	approx. 70 x 60 x 26 mm

NT 9-3AW mains unit

Nominal input voltage	100 V~ to 240 V~
Mains frequency	50–60 Hz
Nominal output voltage	9 V DC
Nominal output current	300 mA
Ambient temperature	+5°C to +40°C

In compliance with

Europe: CE	EMC	EN 301489-1/-9
	Radio	EN 301357-1/-2
	Safety	EN 60065

The devices can be operated license-free in most countries of the European Union.

Approved by

Canada:	Industry Canada RSS 210 IC: 2099A-840
USA:	FC FCC 47 CFR Part 15C FCC-ID: DMOSET840

Transmitters that operate in the 863 – 865 MHz frequency range can be used licence-free in the following countries:

AT, BA, BE, CH, CY, CZ, DE, DK, EE, ES, FI, FR, GB, GR, HU, IE, IS, IT, LI, LT, LU, LV, ME, MK, MT, NL, NO, PL, PT, RO, RS, SE, SI, SK, TR, UA.

The NT 9-3AW mains unit is certified in accordance with the legal safety requirements of Europe, the United States, Canada, China and Russia.

Manufacturer Declarations

Warranty

Sennheiser electronic GmbH & Co. KG gives a warranty of 24 months on this product.

For the current warranty conditions, please visit our website at www.sennheiser.com or contact your Sennheiser partner.

FOR AUSTRALIA ONLY

Sennheiser's goods come with guarantees that cannot be excluded under the Australian Consumer Law. You are entitled to a replacement or refund for a major failure and compensation for any other reasonably foreseeable loss or damage. You are also entitled to have the goods repaired or replaced if the goods fail to be of acceptable quality and the failure does not amount to a major failure.

This warranty is in addition to other rights or remedies under law. Nothing in this warranty excludes, limits or modifies any liability of Sennheiser which is imposed by law, or limits or modifies any remedy available to the consumer which is granted by law.

To make a claim under this warranty, contact Sennheiser Australia Pty Ltd, Unit 3, 31 Gibbes Street, Chatswood NSW 2067, Australia; Phone: (02) 9910 6700, email: service@sennheiser.com.au.

All expenses of claiming the warranty will be borne by the person making the claim.

The Sennheiser International Warranty is provided by Sennheiser Australia Pty Ltd (ABN 68 165 388 312), Unit 3, 31 Gibbes Street, Chatswood NSW 2067, Australia.

In compliance with the following requirements

- WEEE Directive (2012/19/EU)



Please dispose of the devices at the end of their operational lifetime by taking them to your local collection point or recycling center for such equipment.

- Battery Directive (2006/66/EC)



The supplied batteries or rechargeable batteries can be recycled. Please dispose of them as special waste or return them to your specialist dealer. In order to protect the environment, only dispose of exhausted batteries.

CE Declaration of Conformity

- **CE 0682**

- R&TTE Directive (1999/5/EC)
- EMC Directive (2004/108/EC)
- Low Voltage Directive (2006/95/EC)
- RoHS Directive (2011/65/EU)

The declaration is available at www.sennheiser.com. Before putting the devices into operation, please observe the respective country-specific regulations.

Statements regarding FCC and Industry Canada

This equipment complies with Part 15 of the FCC Rules and with RSS-210 of Industry Canada. Operation is subject to the following two conditions: (1) this equipment may not cause harmful interference, and (2) this equipment must accept any interference received, including interference that may cause undesired operation.

This equipment has been tested and found to comply with the limits for a Class B digital device, pursuant to Part 15 of the FCC Rules. These limits are designed to provide reasonable protection against harmful interference in a residential installation. This equipment generates, uses and can radiate radio frequency energy and, if not installed and used in accordance with the instructions, may cause harmful interference to radio communications. However, there is no guarantee that interference will not occur in a particular installation. If this equipment does cause harmful interference to radio or television reception, which can be determined by turning the equipment off and on, the user is encouraged to try to correct the interference by one or more of the following measures:

- Reorient or relocate the receiving antenna.
- Increase the separation between the equipment and receiver.
- Connect the equipment into an outlet on a circuit different from that to which the receiver is connected.
- Consult the dealer or an experienced radio/TV technician for help.

This class B digital equipment complies with the Canadian ICES-003.

Changes or modifications made to this equipment not expressly approved by Sennheiser electronic Corp. may void the FCC authorization to operate this equipment.

Before putting the equipment into operation, please observe the respective country-specific regulations!

Index

Receiver

- Adjusting the balance 18
- Adjusting the volume 16
- Attaching the receiver to clothing 14
- Automatic channel search 17
- Channel indicator (meaning) 22
- Cleaning 25
- No sound signal 26
- Operating elements 5
- Operating time 20
- Reception is subject to interference 17
- Searching for a sound source 17
- Sound is hardly intelligible 27
- Sound is only audible with one ear 27
- Storing and charging the receiver 20
- Switching the acoustic signals off 25
- Switching the receiver on/off 16

Rechargeable battery

- Replacing and charging the rechargeable battery 21

Special functions

- Fine adjusting the speech intelligibility 28
- Treble boost control 29

Terms

- Compression/treble boost 28
- Mono/stereo 19

Transmitter

- Changing the channel 17
- Cleaning 25
- Connection to a headphone socket 8
- Connection to a SCART socket 9
- Connection to a sound source 7
- Connection to an RCA socket 8
- Connection to the mains 11
- Enhancing the speech intelligibility 19
- Installation 6
- Operating elements 5
- Operation indicator (meaning) 22
- Switching between mono and stereo operation 18
- Switching the transmitter on/off 15
- Troubleshooting 26
- Using the MKE 800 TV-N external microphone 9

Versions

- EU version 4
- US version 4



Sennheiser electronic GmbH & Co. KG
Am Labor 1, 30900 Wedemark, Germany
www.sennheiser.com

Printed in China
Publ.09/13
528281/A03

Free Manuals Download Website

<http://myh66.com>

<http://usermanuals.us>

<http://www.somanuals.com>

<http://www.4manuals.cc>

<http://www.manual-lib.com>

<http://www.404manual.com>

<http://www.luxmanual.com>

<http://aubethermostatmanual.com>

Golf course search by state

<http://golfingnear.com>

Email search by domain

<http://emailbydomain.com>

Auto manuals search

<http://auto.somanuals.com>

TV manuals search

<http://tv.somanuals.com>