

SHARP®

MODEL

FO-2950M

FACSIMILE

OPERATION MANUAL

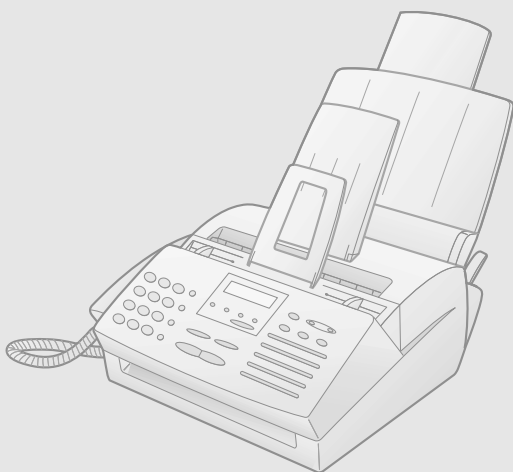

1. Installation
2. Sending Documents
3. Receiving Documents
4. Making Copies
5. Making Telephone Calls
6. Answering Machine Hookup
7. Special Functions
8. Printing Lists
9. Maintenance
10. Troubleshooting

WARNING - FCC Regulations state that any unauthorized changes or modifications to this equipment not expressly approved by the manufacturer could void the user's authority to operate this equipment.

Note: This equipment has been tested and found to comply with the limits for a Class B digital device, pursuant to Part 15 of the FCC Rules. These limits are designed to provide reasonable protection against harmful interference in a residential installation. This equipment generates, uses and can radiate radio frequency energy and, if not installed and used in accordance with the instructions, may cause harmful interference to radio communications. However, there is no guarantee that interference will not occur in a particular installation. If this equipment does cause harmful interference to radio or television reception, which can be determined by turning the equipment off and on, the user is encouraged to try to correct the interference by one or more of the following measures:

- Reorient or relocate the receiving antenna.
- Increase the separation between the equipment and the receiver.
- Connect the equipment into an outlet on a circuit different from that to which the receiver is connected.
- Consult the dealer or an experienced radio/TV technician for help.

ABOUT THE TELEPHONE CONSUMER PROTECTION ACT OF 1991

"The Telephone Consumer Protection Act of 1991 makes it unlawful for any person to use a computer or other electronic device to send any message via a telephone facsimile machine unless such message clearly contains in a margin at the top or bottom of each transmitted page or on the first page of the transmission the following information:

- (1) The date and time of transmission.
- (2) Identification of either the business, business entity or individual sending the message.
- (3) Telephone number of either the sending machine, business, business entity or individual.

In order to program this information into your facsimile machine, please refer to the appropriate instructions in the operation manual."



As an ENERGY STAR® partner, SHARP has determined that this product meets the ENERGY STAR® guidelines for energy efficiency.

Declaration of Conformity

SHARP LASER FACSIMILE, FO-2950M

This device complies with Part 15 of the FCC rules. Operation is subject to the following two conditions:

- (1) This device may not cause harmful interference, and (2) this device must accept any interference received, including interference that may cause undesired operation.

Responsible Party:

SHARP ELECTRONICS CORPORATION Sharp Plaza,
Mahwah, New Jersey 07430-2135 TEL: 800-237-4277

Introduction

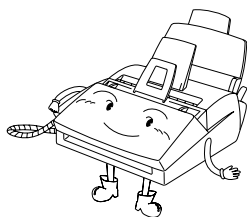

Welcome, and thank you for choosing a Sharp facsimile! The features and specifications of your new Sharp fax are shown below.

Automatic dialing	Rapid Key Dialing: 20 numbers Speed Dialing: 100 numbers
Memory size*	2 MB (approx. 130 pages)
Modem speed	14,400 bps (max.) Automatic fallback to lower speeds.
Transmission time*	Approx. 6 seconds
Toner cartridge yield (4% page coverage, letter paper)	Initial starter cartridge (included with fax machine): Approx. 1,875 pages Replacement cartridge (FO-29ND): Approx. 3,750 pages
Drum cartridge yield	Initial starter cartridge (included with fax machine): 20,000 pages (ave.) Replacement cartridge (FO-29DR): 20,000 pages (ave.)
Scanning resolution	Fax/copy: Horizontal: 203 pels/inch (8 pels/mm) Vertical: Standard: 98 lines/inch (3.85 lines/mm) Fine /Halftone: 196 lines/inch (7.7 lines/mm) Super fine: 391 lines/inch (15.4 lines/mm) PC: Enhanced 600 dpi

*Based on ITU-T Test Chart #1 at standard resolution in Sharp special mode, excluding time for protocol signals (i.e., ITU-T phase C time only).

Automatic document feeder	20 pages max. (20-lb. letter paper)
Halftone (grayscale)	64 levels (PC scan: 256 levels)
Paper tray capacity	200 sheets (20-lb. letter paper)
Compression scheme	MMR, MR, MH, Sharp (H2)
Applicable telephone line	Public switched telephone network
Compatibility	ITU-T (CCITT) G3 mode
Printing resolution	Horizontal: 406 lines/inch (16 lines/mm) Vertical: 391 lines/inch (15.4 lines/mm) PC Printing: 600 dpi (enhanced 1,800 dpi)
Input document size	Automatic feeding: Width: 5.8 to 8.5" (148 to 216 mm) Length: 5.5 to 11" (140 to 279 mm) Manual feeding: Width: 5.8 to 8.5" (148 to 216 mm) Length: 5.5 to 39.4" (140 to 1,000 mm)
Effective Scanning width	8.3" (210 mm) max.
Effective Printing width	8.2" (208 mm) max.
Reception modes	Fax/Tel/A.M.
Scanning speed	8 ppm (letter paper)
Full Dual Access	Yes
Copy function	Single/Multi/Sort (99 copies/page)
Power requirements	120 V AC, 60 Hz
Operating temperature	50 - 86°F (10 - 30°C)
Humidity	20 to 85% RH
Power consumption	Standby: 8.7 W Maximum: 650 W

Dimensions	Width: 15.2" (386 mm)
	Depth: 15.7" (398 mm)
	Height: 6.7" (169 mm)
Weight	Approx. 13.8 lbs. (6.3 kg)

As a part of our policy of continuous improvement, SHARP reserves the right to make design and specification changes for product improvement without prior notice. The performance specification figures indicated are nominal values of production units. There may be some deviations from these values in individual units.

Important safety information

Be sure to save these instructions!

When using your facsimile equipment, basic safety precautions should always be followed to reduce the risk of fire, electric shock and injury to persons, including the following:

- Do not disassemble this machine or attempt any procedures not described in this manual. Refer all servicing to qualified service personnel.
- This machine must only be connected to a 120 V, 60 Hz, grounded (3-prong) outlet. Connecting it to any other kind of outlet will damage the machine and invalidate the warranty.
- Do not install or use the machine near water, or when you are wet. For example, do not use the machine near a bath tub, wash bowl, kitchen sink or laundry tub, in a wet basement, or near a swimming pool. Take care not to spill any liquids on the machine.
- Unplug the machine from the telephone jack and then the power outlet and consult a qualified service representative if any of the following situations occur:

- Liquid has been spilled into the machine or the machine has been exposed to rain or water.
 - The machine produces odors, smoke, or unusual noises.
 - The power cord is frayed or damaged.
 - The machine has been dropped or the housing damaged.
- Do not allow anything to rest on the power cord, and do not install the machine where people may walk on the power cord.
 - Never insert objects of any kind into slots or openings on the machine. This could create a risk of fire or electric shock. If an object falls into the machine that you cannot safely remove, unplug the machine and consult a qualified service representative.
 - Do not place this machine on an unstable cart, stand or table. The machine could be seriously damaged if it falls.
 - Avoid using a telephone (other than a cordless type) during an electrical storm. There may be a remote risk of electric shock from lightning.
 - Do not use a telephone to report a gas leak in the vicinity of the leak.
 - The power outlet must be installed near the equipment and must be easily accessible.

Important:

- This facsimile machine is not designed for use on a line which has call waiting, call forwarding, or certain other special services offered by your telephone company. If you attempt to use the fax machine in conjunction with any of these services, you may experience errors during transmission and reception of facsimile messages.
- This facsimile machine is not compatible with digital telephone systems.

Table of Contents

Introduction	1
Important safety information	3
Table of Contents	5
A Look at the Operation Panel	7
1. Installation	10
Unpacking Checklist	10
Connections	11
Installing the Toner Cartridge	17
Loading Printing Paper	21
Setting Up the Multifunction Interface	24
Entering Your Name and Fax Number	28
Setting the Date and Time	32
Setting the Reception Mode	35
Volume Adjustment	38
2. Sending Documents	42
Transmittable Documents	42
Loading the Document	44
Adjusting the Resolution and Contrast	47
Sending a Fax by Normal Dialing	50
Sending a Fax by Automatic Dialing	52
3. Receiving Documents	67
Using FAX Mode	67
Using TEL Reception Mode	69
Substitute Reception to Memory	75
4. Making Copies	76
5. Making Telephone Calls	79

6. Answering Machine Hookup	81
Connecting an Answering Machine	81
Optional A.M. Mode Settings	84
7. Special Functions	86
Broadcasting	86
Distinctive Ring (Requires Subscription to Service)	91
Cover Sheet	94
Batch Page Numbering	97
Blocking Reception of Unwanted Faxes	99
Polling (Requesting a Fax Transmission)	101
Timer Operations	107
8. Printing Lists	110
9. Maintenance	117
Scanning glass and rollers	117
The housing	117
Replacing the toner cartridge	118
Replacing the drum cartridge	119
Cleaning the drum cartridge	122
10. Troubleshooting	124
Problems and Solutions	124
Messages and Signals	130
Clearing Paper Jams	133
FCC Regulatory Information	137
Quick Reference Guide	140
Guía de referencia rápida	142
Index	144

A Look at the Operation Panel

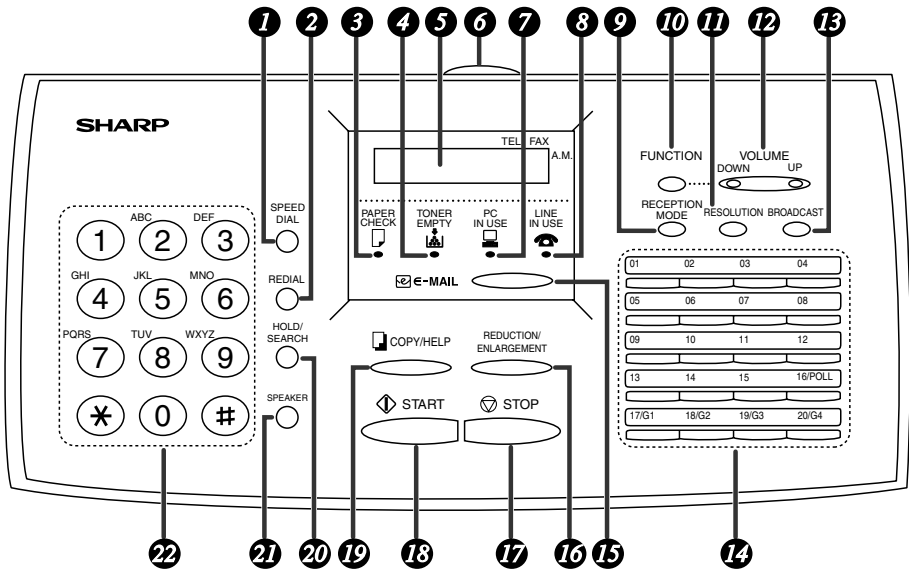

- 1** **SPEED DIAL** key
Press this key to dial a fax or voice number using an abbreviated 2-digit Speed Dial number.
- 2** **REDIAL** key
Press this key to automatically redial the last number dialed.
- 3** **PAPER CHECK** indicator
This lights when the paper tray is out of paper, the paper has jammed, the printer compartment cover is open, or a paper size error has occurred.
- 4** **TONER EMPTY** indicator
This blinks when the toner cartridge nears empty and lights steadily when the toner cartridge needs replacement.
- 5** **Display**
This displays messages and prompts during operation and programming.

- 6 Panel release**
Grasp this release and pull toward you to open the operation panel.
- 7 PC IN USE light**
This blinks when data is being sent to or from the computer connected to the fax machine.
- 8 LINE IN USE light**
This lights when the fax machine is using the telephone line.
- 9 RECEPTION MODE key**
Press this key to select the reception mode. An arrow in the display will point to the currently selected reception mode.
- 10 FUNCTION key**
Press this key to select special functions and settings.
- 11 RESOLUTION key**
Press this key to adjust the resolution for faxing or copying.
- 12 VOLUME (UP/DOWN) keys**
Press these keys to adjust the volume of the speaker when the **SPEAKER** key has been pressed, the volume of the handset when the handset is lifted, or the volume of the ringer at all other times. The keys can also be used to scroll through **FUNCTION** key settings.
- 13 BROADCAST key**
Press this key to send a document to a group of receiving fax machines.
- 14 Rapid Dial Keys**
Press one of these keys to dial a fax number automatically, or send a document as an E-mail attachment to a preset E-mail address.
- 15 E-MAIL key**
Press this key to send a document as an E-mail attachment. After you press the key, your specified E-mail program will open to let you enter the E-mail address, a subject, and a message if desired.

- 16 REDUCTION/ENLARGEMENT key**
Press this key to select an enlargement or reduction setting when making a copy of a document.
- 17 STOP key**
Press this key to cancel an operation before it is completed.
- 18 START key**
Press this key to begin transmission when using Speed Dialing, Direct Keypad Dialing, or Normal Dialing.
- 19 COPY/HELP key**
When a document is in the feeder, press this key to make a copy of a document. At any other time, press this key to print out the Help List, a quick reference guide to the operation of your fax machine.
- 20 HOLD/SEARCH key**
When dialing, press this key to search for an auto-dial fax number. During a phone conversation, press this key to put the other party on hold.
- 21 SPEAKER key**
Press this key to listen to the line and fax tones through the speaker when faxing a document.
Note: **This is not a speakerphone.** You must pick up the handset to talk with the other party.
- 22 Number keys**
Use these keys to dial numbers, and enter numbers and letters when storing auto-dial numbers.

1. Installation

Unpacking Checklist

Before setting up, make sure you have all of the following items.



If any are missing, contact your dealer or retailer.

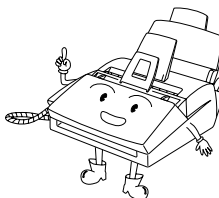

Original document support



Handset



Handset cord

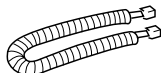

Toner cartridge

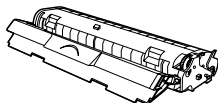

Drum cartridge (comes pre-installed in machine)

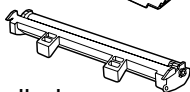

Rapid Key labels



Received document tray



Operation manual

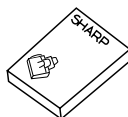

Telephone line cord



Paper tray

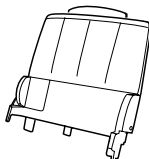

Sharp Laser Multifunction CD-ROM



Connections

Points to keep in mind when setting up

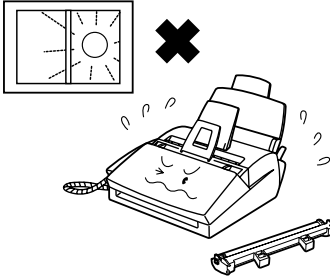

Do not place the machine and the drum cartridge in direct sunlight.

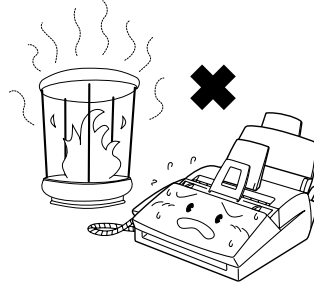

Do not place the machine near heaters or air conditioners.

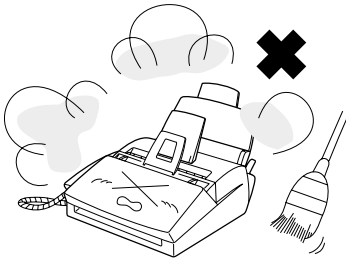

Keep dust away from the machine.

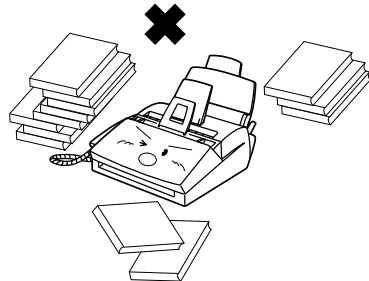

Keep the area around the machine clear.

About condensation

If the machine is moved from a cold to a warm place, it is possible that condensation may form on the scanning glass, preventing proper scanning of documents for transmission. To remove the condensation, turn on the power and wait approximately two hours before using the machine.

Connecting the Handset

Connect the handset as shown and place it on the handset rest.

- ◆ The ends of the handset cord are identical, so they will go into either jack.

Make sure the handset cord goes into the jack marked with a handset symbol on the side of the machine!

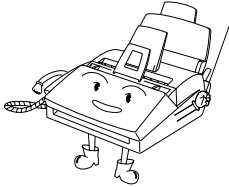
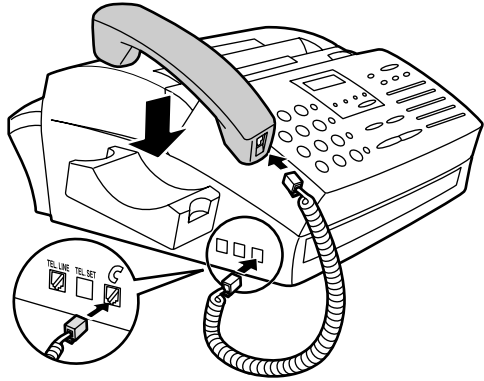

Use the handset to make ordinary phone calls, or to transmit and receive faxes manually.



Connecting the power cord

Plug the power cord into a 120 V, 60 Hz, grounded AC (3-prong) outlet.

Caution!

Do not plug the power cord into any other kind of outlet. This will damage the machine and is not covered under the warranty.

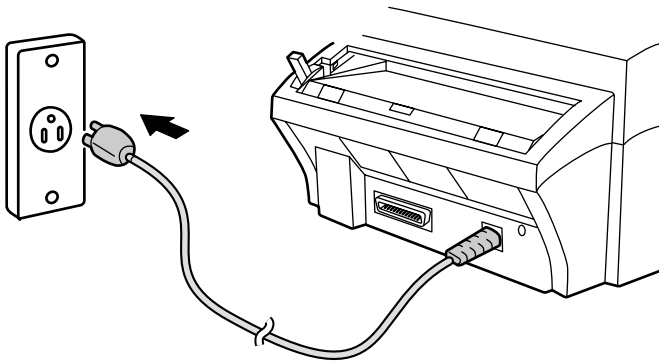

The machine does not have a power on/off switch, so the power is turned on and off by simply plugging in or unplugging the power cord.

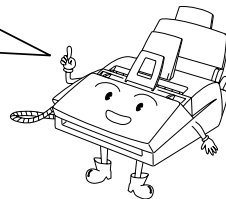

Note: If your area experiences a high incidence of lightning or power surges, we recommend that you install surge protectors for the power and telephone lines. Surge protectors can be purchased at most telephone specialty stores.

Connecting the telephone line cord

Insert one end of the line cord into the jack on the left of the machine marked **TEL. LINE**. Insert the other end into a standard (RJ11C) single-line wall telephone jack.

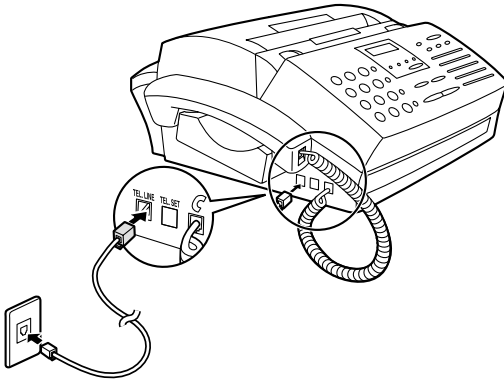

Be sure to insert the line into the **TEL. LINE** jack. **Do not** insert it into the **TEL. SET** jack.

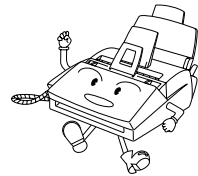

Note: Your fax is set for tone dialing. If you are on a pulse dial line, you must set your fax for pulse dialing. Press the keys on the operation panel as follows:

1 Press these keys: **FUNCTION** **4** → **# # # #**
The display will show: **# # # # #**

DIAL MODE
1=TONE, 2=PULSE

2 Press **1** to select tone dialing, or **2** to select pulse dialing.

TONE **PULSE**
1 or **2**

3 Press the **STOP** key to return to the date and time display.



Attaching the paper tray and document supports

Attach the paper tray.

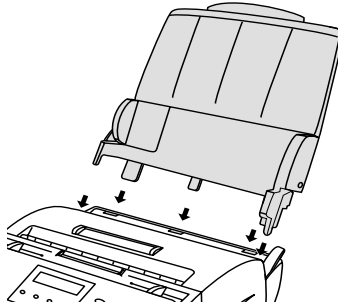

Attach the received document tray.

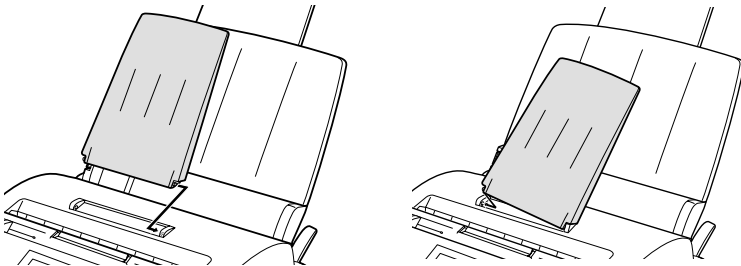

Attach the original document support.

- ◆ Make sure the front side of the support faces you (the support should curve slightly toward you).

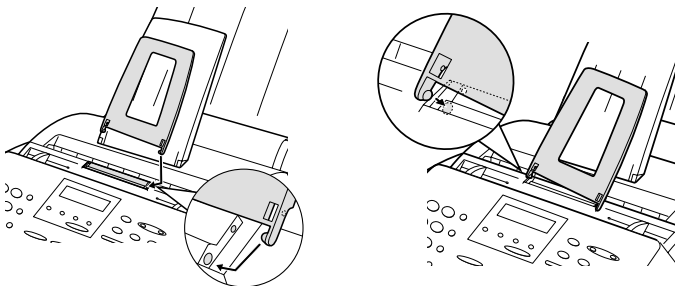

Extension phone (optional)

If desired, you can connect an extension phone to the **TEL. SET** jack on the fax.

- ◆ To connect an answering machine to your fax, see Chapter 6, *Answering Machine Hookup*.

-
- 1** Remove the seal covering the **TEL. SET** jack.

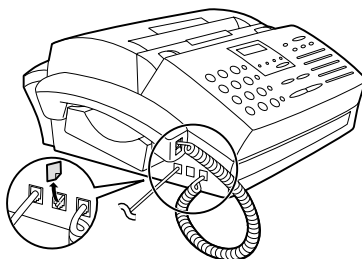

-
- 2** Connect the extension phone line to the **TEL. SET** jack.

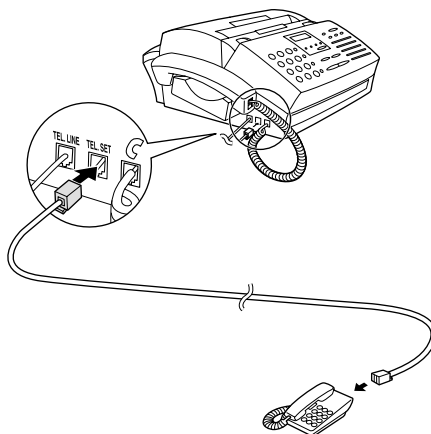

Installing the Toner Cartridge

The laser printer in your fax machine uses a toner cartridge and a drum cartridge. The drum cartridge comes pre-installed, and the toner cartridge must be installed.

The starter toner cartridge included with your fax can print approximately 1,875 letter-size pages at 4% page coverage.



When replacing the toner cartridge, use a Sharp FO-29ND toner cartridge. One cartridge can print about 3,750 letter-size pages.

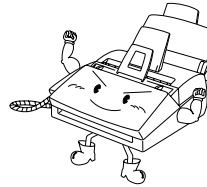

- ◆ The drum cartridge can print approximately 20,000 letter-size pages. When replacing the drum cartridge, use a Sharp FO-29DR drum cartridge.

Follow the steps below to install the toner cartridge and prepare the drum cartridge.

- 1 Grasp the print compartment cover at both sides as shown, and pull up to open the cover.

- **Caution!**
The fusing unit inside the print compartment becomes very hot during operation. Do not touch the inside of the compartment or the paper guide on the underside of the print compartment cover.

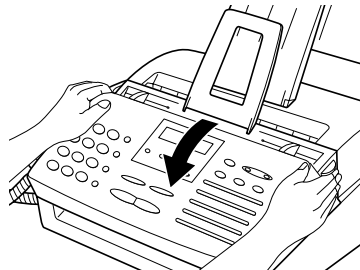

2 The drum cartridge has been installed at the factory. Gently pull the paper tab to remove the black sheet of protective paper from the cartridge.

- Be careful not to tear the paper nor leave any pieces of paper in the machine.

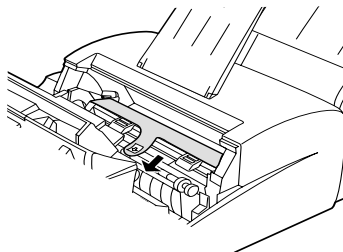

3 Remove the new toner cartridge from its packaging. Shake the cartridge side to side four or five times to distribute the toner evenly within the cartridge.

Carefully remove the band and the cardboard packaging material from the toner cartridge.

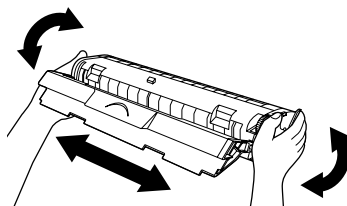

-
- 4** Hold the toner cartridge by the handle with the stamped markings on the cartridge facing upwards, and insert the cartridge into the print compartment.

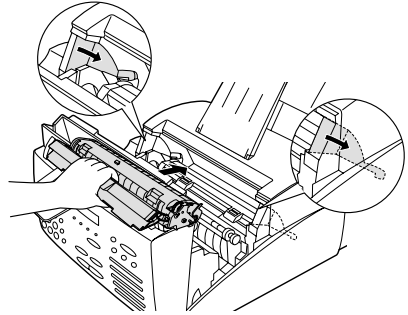

-
- 5** Place your thumb on the center of the handle where it is marked **PUSH**, and push the handle down and in so that the cartridge fits into place.

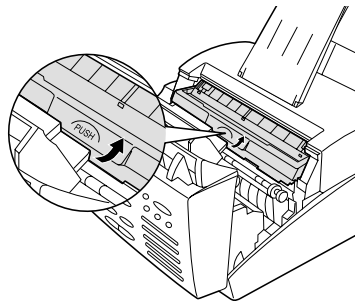

-
- 6** Close the print compartment cover, pressing down firmly on each side to make sure it is completely closed.

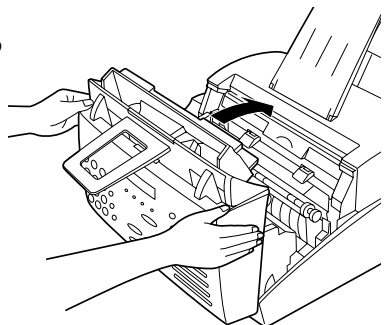

- 7 Reset the toner counter by pressing the following keys:

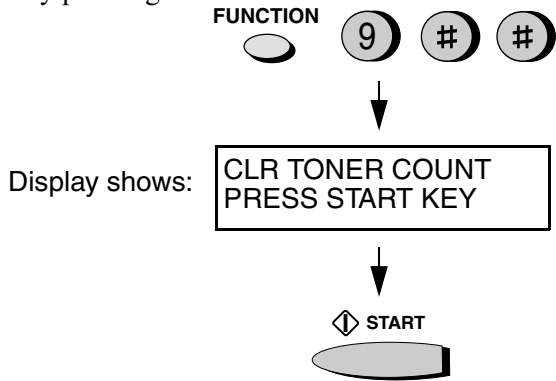

- 8 Reset the drum counter by pressing the following keys:

- **Note:** This setting is only necessary after you have replaced the drum cartridge (not after replacing the toner cartridge).

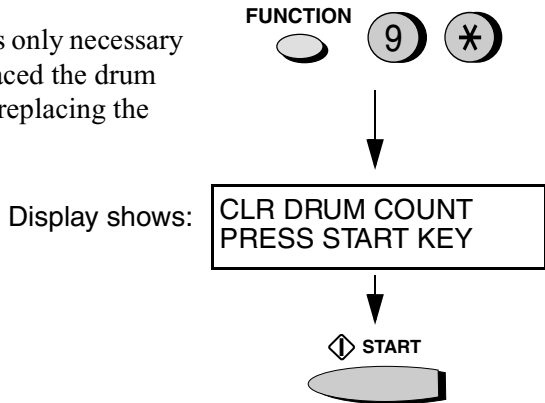

Loading Printing Paper

You can load up to 200 sheets of letter, A4 or legal paper (max. 20 lbs.) in the paper tray.

Caution!

Do not use the blank side of paper that has already been printed on.

- 1** If you are going to load legal size paper, pull out the paper tray extension.

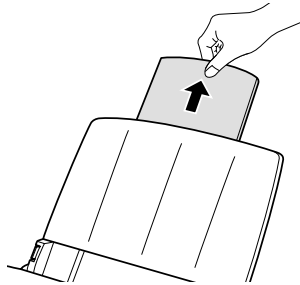

- 2** Fan the paper, and then tap the edge against a flat surface to even the stack.

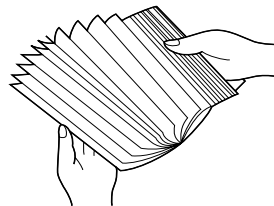

- 3** Pull the paper release lever toward you.

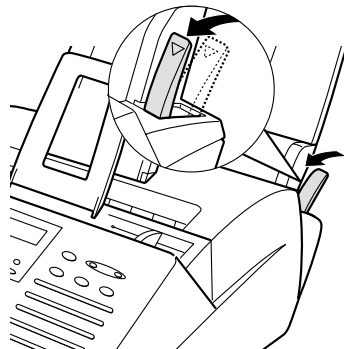

4 Insert the stack of paper **firmly** into the tray, **print side up**.

- Make sure that the stack is not higher than the marked line. Loading too much paper may cause paper jams and misfeeds.
- If paper remains in the tray, take it out and combine it into a single stack with the new paper before adding the new paper.

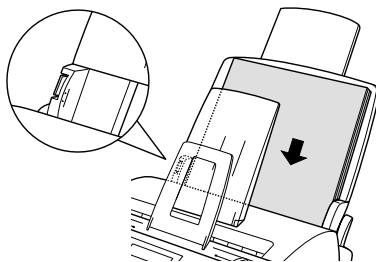

Important:

Be sure to load the paper so that printing takes place on the **print** side of the paper. Printing on the reverse side may result in poor print quality.

5 Make sure the stack of paper is aligned against the right paper guide, and then gently move the left paper guide to the **8 1/2** position for letter or legal paper, or the **A4** position for A4 paper.

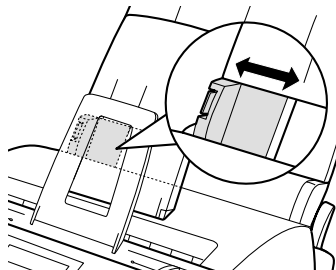

6 Push the paper release lever back down.

- **Note:** If the paper does not feed correctly, remove the entire stack from the tray and repeat the loading procedure from the beginning.



- 7** The fax has been set at the factory to scale the size of received faxes to letter size paper. If you have loaded legal paper, you must change the paper size setting to legal. Press these keys:

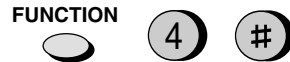

The display will show:

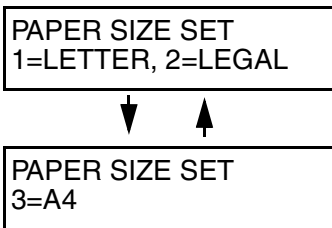

Press **1** to select LETTER or **2** to select LEGAL. (You can also press **3** to select A4.)

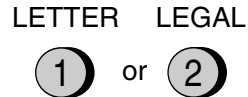

The display will briefly show your selection and then show:

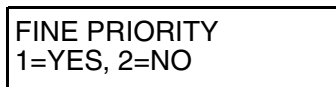

Press the **STOP** key to return to the date and time display.



Setting Up the Multifunction Interface

To enable the multifunction features of your fax, connect it to your computer and install the Multifunction software.

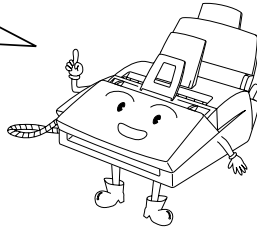

Connecting the parallel cable

Connect the fax machine to your computer with a parallel cable.

- ◆ If you do not already have a parallel cable, you can purchase one from your dealer or any computer store.
- ◆ Make sure the cable is IEEE 1284-compliant. We recommend a shielded cable no longer than 6 feet.

-
- 1** Make sure your computer is turned off and the fax machine is unplugged.

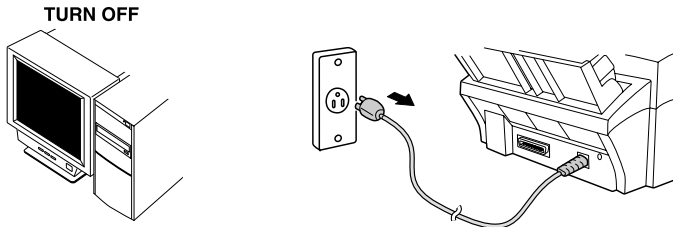

-
- 2** Connect one end of the cable to the port on the Sharp Laser Multifunction. Snap the clips on each side of the port onto the cable connector to secure it.

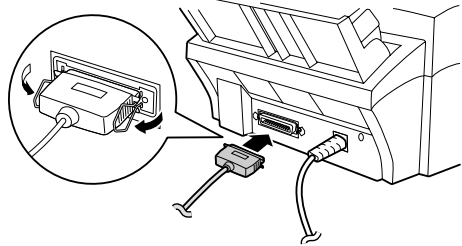

-
- 3** Connect the other end of the cable to the parallel port on the back of your computer.

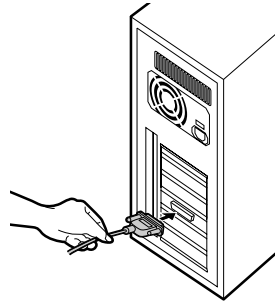

Note: There is normally no need to change the parallel port setting in your computer's setup (BIOS) program. However, if you find that the Sharp Laser Multifunction fax does not operate well when scanning or printing, you may need to change the setting. In this case select ECP, PS2, Bi-directional, or an equivalent parallel port mode.

Installing the Multifunction software

Minimum system requirements

Processor:	Pentium 90 MHz or higher
Operating system:	Windows [®] 95/98, Windows NT [®] 4.0 (Service Pack 3 or later), English version
Physical RAM:	Windows 95/98: 16 MB Windows NT 4.0: 32 MB
Free hard-disk space:	Windows 95/98: 30 MB Windows NT 4.0: 35MB

- ◆ The Sharp Laser Multifunction software cannot be installed by Plug and Play. If the **New Hardware Found** box appears when you turn on your computer, click the **Cancel** button to exit the dialog box.
 - ◆ If you have other multifunction device software installed in your computer, uninstall that software before installing the Sharp Laser Multifunction software. Otherwise, the Sharp Laser Multifunction software may not function correctly.
1. Insert the Sharp Laser Multifunction CD into your computer's CD-ROM drive.
 2. If the **Sharp Laser Multifunction Setup** window appears, click **Next** in the window and go to step 4. If the window doesn't appear, click the **Start** button on the Windows taskbar and select the **Run...** command.
 3. Type **e:\setup** in the **Open** text box, where **e** is the letter of your CD-ROM drive, and then click **OK**.
 4. Follow the instructions that appear on the screen.
 5. When installation is completed, restart your computer.

Online Operation Guide

Detailed instructions for using the Sharp Laser Multifunction software can be found in the Online Guide on the CD. To open the guide, follow these steps:

- 1.** Insert the Sharp Laser Multifunction CD into your CD-ROM drive. (If the **Sharp Laser Multifunction Setup** window appears, click **Cancel** and then **Exit Setup** to close the window.)
- 2.** Click the **Start** button on the Windows taskbar, point to **Programs**, and then point to **Sharp Laser Multifunction**. Click **Online Guide**.

Entering Your Name and Fax Number

Before you can begin using your fax machine, you must enter your name and fax (telephone) number. You also need to set the date and time.



Once you enter this information, it will automatically appear at the top of each fax page you send.

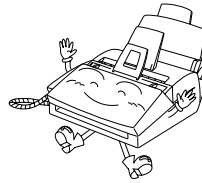

Important!

The law requires that your name, telephone/fax number, and the date and time appear on each fax message you send. Enter your name and fax number here and set the date and time as explained in the following section to have the fax machine include this information automatically at the top of your fax messages.

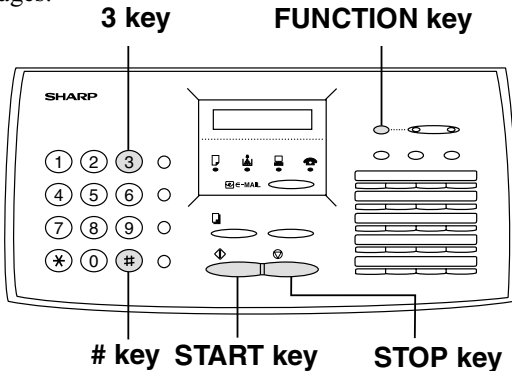

1 Press these keys:

FUNCTION

3

The display will show:

ENTRY MODE
PRESS * OR #

- 2** Press the # key twice.
(Or the UP key twice.)



The display will show:

OWN NUMBER SET
PRESS START KEY

Note: When scrolling through the settings, you can press the UP key in place of the # key, and the DOWN key in place of the * key.

- 3** Press the START key.



The display will show:

ENTER FAX #

- 4** Enter your fax number by pressing the number keys (max. of 20 digits).

- To insert a space between digits, press the # key.
- If you make a mistake, press the SPEED DIAL key to backspace and clear the mistake.

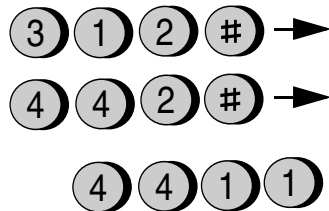

(Example)

- 5** Press the START key to enter the fax number in memory.























































































The display will show:

ENTER YOUR NAME

- 6** Enter your name by pressing number keys for each letter as shown in the chart below. Up to 24 characters can be entered.

Example: SHARP = 77777 444 22 7777  77

SPACE =  	J =  	T =  
A =  	K =   	U =   
B =   	L =    	V =    
C =    	M =  	W =  
D =  	N =   	X =   
E =   	O =    	Y =    
F =    	P =  	Z =     
G =  	Q =   	
H =   	R =    	
I =    	S =     	

- ◆ To enter two letters in succession that require the same key, press the **SPEAKER** key after entering the first letter. (The **SPEAKER** key moves the cursor forward, and the **HOLD/SEARCH** key moves the cursor backward.)
- ◆ To clear a mistake, press the **SPEED DIAL** key.
- ◆ To change case, press the **REDIAL** key.
- ◆ To select one of the following symbols, press the # key or the * key repeatedly:
 . / ! " # \$ % & ' () * + , - : ; < = > ? @ [] ^ _ ' { | }

Cursor: A dark square mark in the display that indicates where a number or letter will be entered.

7 Press the **START** key.

The display will show:

SECURITY SELECT
1=ON, 2=OFF

 **START**



8 Press the **STOP** key to return to the date and time display.

 **STOP**



Setting the Date and Time

The date and time appear in the display and are printed at the top of every page you fax.

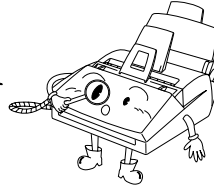

Set the date and time by pressing the keys on the operation panel as shown below.

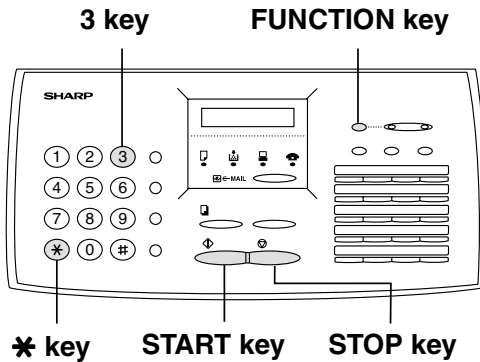

1 Press these keys:



The display will show:

ENTRY MODE
PRESS * OR #

2 Press these keys:



The display will show:

DATE & TIME SET
PRESS START KEY

3 Press the **START** key.

- The currently set date will appear in the display.



4 Enter a two-digit number for the month (“01” for January, “02” for February, “12” for December, etc.).

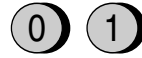

- To correct a mistake, press the **SPEED DIAL** key to move the cursor back to the mistake and then enter the correct number.

Example: January

5 Enter a two-digit number for the day (“01” to “31”).

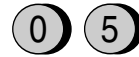

Example: the 5th

6 Enter the year (four digits).



Example: 2000

7 Enter a two-digit number for the hour (“01” to “12”) and a two-digit number for the minute (“00” to “59”).



Example: 9:25

8 Press the ***** key to select A.M. or the **#** key to select P.M.

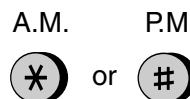

-
- 9** Press the **START** key to start the clock.



The display will show:

DAY LIGHT SAVING
1=YES, 2=NO

-
- 10** Press the **STOP** key to return to the date and time display.



Daylight Saving Time

If desired, you can set the clock to move forward and backward automatically at the beginning and end of Daylight Saving Time. To turn on this function, press the panel keys as follows:

-
- 1** Press these keys:



The display will show:

DAY LIGHT SAVING
1:YES, 2=NO

-
- 2** Press **1** to turn on the Daylight Saving Time function, or **2** to turn it off.

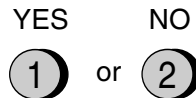

-
- 3** Press the **STOP** key to return to the date and time display.



Setting the Reception Mode

Your fax machine has three modes for receiving incoming calls and faxes:

TEL mode:

Select this mode when you want to receive both phone calls and faxes on the line connected to the fax machine. **All calls, including faxes, must be answered by picking up the fax machine's handset** or an extension phone connected to the same line.

FAX mode:

Select this mode when you only want to receive faxes on your line. The fax machine will automatically answer all calls on four rings and receive incoming faxes.

A.M. mode:

Use this mode only if you have connected an answering machine to the fax (see Chapter 6). Select this mode when you go out to receive voice messages in your answering machine and faxes on your fax machine.

Setting the reception mode

Press the **RECEPTION MODE** key until the arrow in the display points to the desired mode.

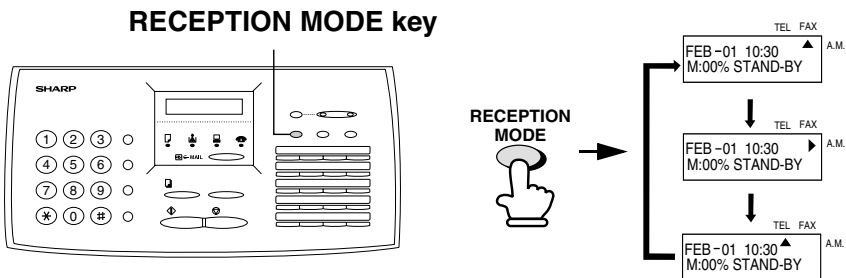

For more information on receiving faxes in TEL and FAX modes, see Chapter 3, *Receiving Documents*. For more information on using A.M. mode, see Chapter 6, *Answering Machine Hookup*.

Selecting the receiving unit

If you have connected the fax machine to a computer and installed the Multifunction software, you can choose whether to have incoming faxes received to the fax machine or the computer.

- ◆ The initial setting is FAX (reception to the fax machine).

1 Press these keys:



The display will show:

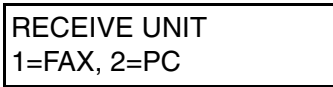

2 Press **1** (FAX) to select the fax machine, or **2** (PC) to select the computer.

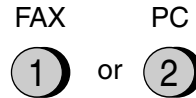

- The display briefly shows your selection and then reverts to the date and time display.

3 If you selected reception to the computer and want the computer to answer all calls automatically, set the reception mode of the fax machine to FAX.

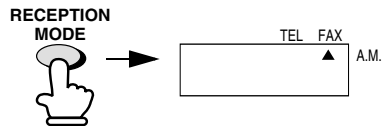

- Make sure the Multifunction Desktop software is running and **Fax Receive** is selected (a checkmark appears next to it) in the Fax menu of the Multifunction Desktop. (If not, the fax machine will receive faxes.)

- 4** If you selected reception to the computer but also want to receive voice calls, set the reception mode of the fax machine to TEL.

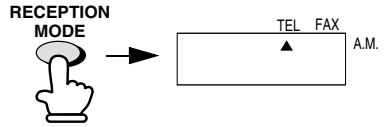

- **You must answer all calls using the fax's handset.** The Multifunction Desktop will receive a fax only if the sending machine issues a fax tone. (Make sure that **Fax Receive** is selected in the Fax menu of the Multifunction Desktop.) To receive the fax to your fax machine, press the **START** key.

- 5** If you selected reception to the computer but also want to receive voice messages in an answering machine connected to the fax machine as explained in Chapter 6, set the reception mode of the fax machine to A.M.

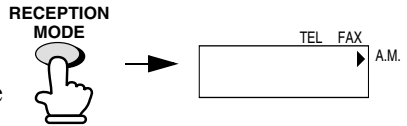

Volume Adjustment

You can adjust the volume of the speaker, handset, and ringer using the **UP** and **DOWN** keys.

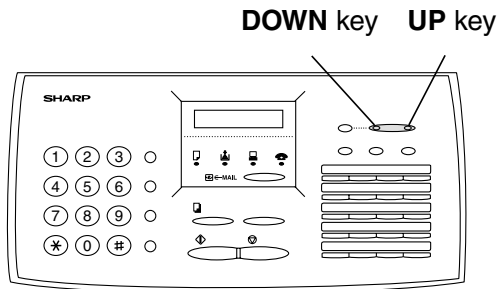

Speaker

- 1 Press the **SPEAKER** key.

SPEAKER



- 2 Press the **UP** or **DOWN** key.

Display:

JAN-29 01:44
SPEAKER : HIGH



JAN-29 01:44
SPEAKER : MIDDLE



JAN-29 01:44
SPEAKER : LOW

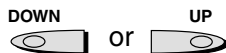

-
- 3** When the display shows the desired volume level, press the **SPEAKER** key to turn off the speaker.



Handset

- 1** Lift the handset.

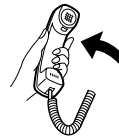

-
- 2** Press the **UP** or **DOWN** key.

Display:

JAN-29 01:44
RECEIVER : HIGH



JAN-29 01:44
RECEIVER : MIDDLE



JAN-29 01:44
RECEIVER : LOW

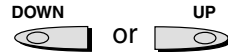

-
- 3** When the display shows the desired volume level, replace the handset.

- Note: The handset volume reverts to medium each time you hang up.



Ringer

1 Press the **UP** or **DOWN** key. (Make sure the **SPEAKER** key has not been pressed.)

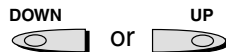

- The ringer will ring once at the selected level, and then the date and time will reappear in the display.

Display:

JAN-29 01:44
RINGER : HIGH



JAN-29 01:44
RINGER : MIDDLE



JAN-29 01:44
RINGER : LOW



RINGER : OFF OK ?
OK:PRESS START

2 If you selected RINGER : OFF OK?, press the **START** key.



Beep length

Your fax machine normally signals the end of transmission, reception, or copying with a 3-second beep. If desired, you can change the duration of the beep to 1 second or turn the beep off.

- 1** Press these keys:

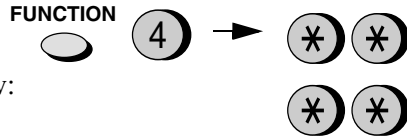

The display will alternately show:

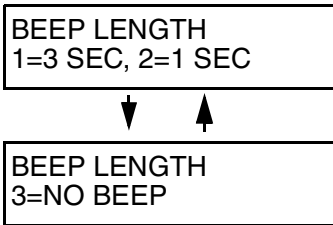

- 2** Press **1** for 3 seconds, **2** for 1 second, or **3** for no beep.



Example:
No beep

- 3** Press the **STOP** key to return to the date and time display.



2. Sending Documents

Transmittable Documents

Size and weight

The size and weight of documents that you can load in the document feeder depend on whether you load one page at a time or several pages at once.

Loading one page at a time:

Minimum size

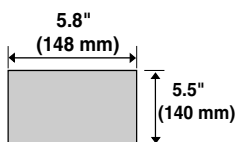

Maximum size

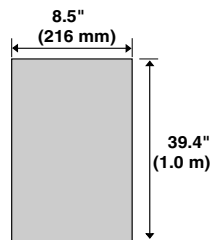

Minimum weight

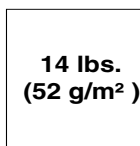

Maximum weight

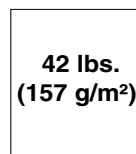

Loading several pages at once:

Minimum size

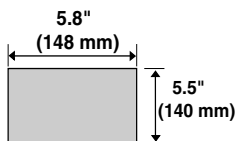

Maximum size

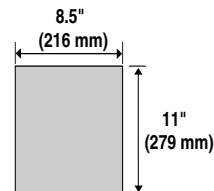

Minimum weight

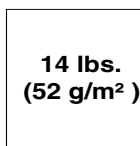

Maximum weight

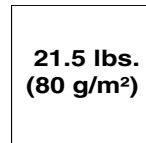

Note: Letters or graphics on the edges of a document will not be scanned.

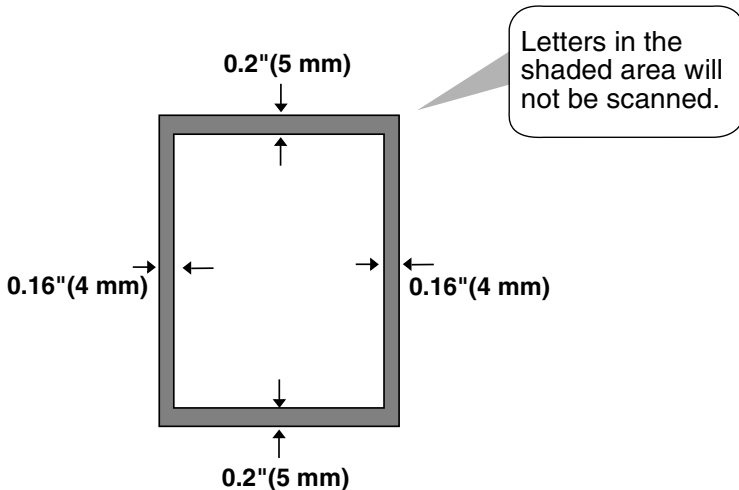

Other restrictions

- ◆ The scanner cannot recognize yellow, greenish yellow, or light blue ink.
- ◆ Ink, glue, and correcting fluid on documents must be dry before they pass through the document feeder.
- ◆ All clips, staples, and pins must be removed from documents before loading in the feeder. If these are not removed, they may damage the machine.
- ◆ Documents which are patched, taped, torn, smaller than the minimum size, carbon backed, easily smudged, or have a slick coated surface should be photocopied, and the copy loaded in the feeder.

Loading the Document

Up to 20 pages can be placed in the feeder at one time. The pages will automatically feed into the machine starting from the bottom page.

- ◆ If you need to send or copy more than 20 pages, place the additional pages gently and carefully in the feeder just before the last page is scanned. Do not try to force them in, as this may cause double-feeding or jamming.
- ◆ If your document consists of several large or thick pages which must be loaded one at a time, insert each page into the feeder as the previous page is being scanned. Insert gently to prevent double-feeding.

-
- 1** Adjust the document guides to the width of your document.

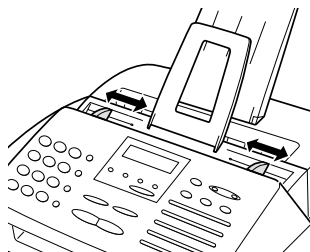

-
- 2** Place the document face down and push it gently into the document feeder. The top edge of the document should enter the machine first.

- The feeder will draw the leading edge of the document into the machine. SEND READY will appear in the display.

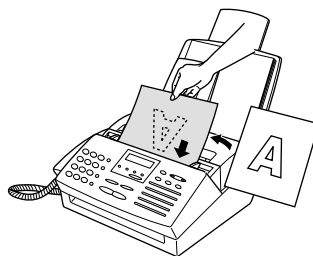

- Adjust the resolution and/or contrast settings (if desired) as explained in the section *Resolution and Contrast* on the following pages, then dial the receiving machine as explained in *Sending a Fax by Normal Dialing* which appears later in this section.

RESOLUTION**Removing a document from the feeder**

If you need to remove a document from the feeder, open the operation panel.

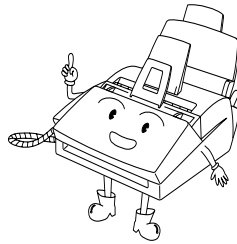
**Important!**

Do not try to remove a document without opening the operation panel. This may damage the feeder mechanism.

- Grasp the panel release and pull up to open the operation panel.

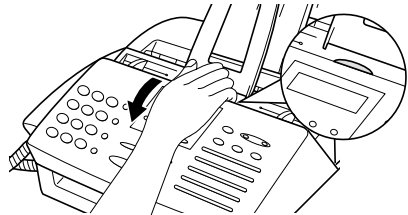

2 Remove the document.

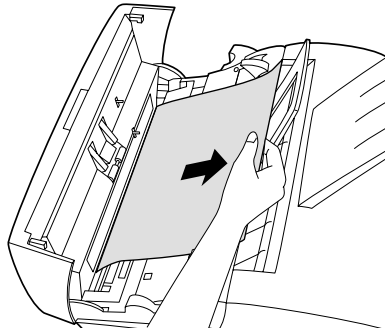

3 Close the operation panel, making sure it clicks into place.

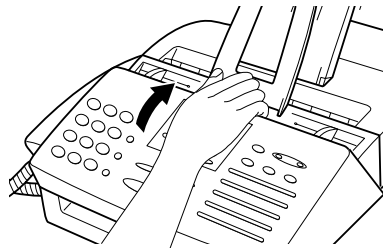

Adjusting the Resolution and Contrast

If desired, you can adjust the resolution and contrast before sending a document.

The default resolution setting is STANDARD and the default contrast setting is AUTO.

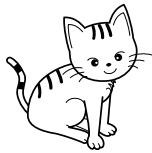

You must adjust the settings each time you don't want to use the default settings.

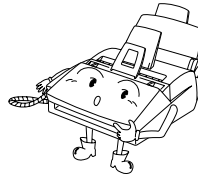

Note: The resolution and contrast settings are only effective for sending and copying a document. They are not effective for receiving a document.

Resolution settings

STANDARD	Use STANDARD for ordinary documents. This setting gives you the fastest and most economical transmission.
FINE	Use FINE for documents containing small letters or fine drawings.
SUPER FINE	Use SUPER FINE for documents containing very small letters or very fine drawings.
HALF TONE	Use HALF TONE for photographs and illustrations. The original will be reproduced in 64 shades of gray.

Contrast settings

AUTO	Use AUTO for normal documents.
DARK	Use DARK for faint documents.

1 Load the document(s).

- The document must be loaded before the resolution and contrast can be adjusted.

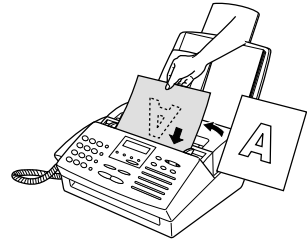

2 Press the **RESOLUTION** key one or more times until the desired resolution and contrast settings appear in the display.

- The first time you scroll through the list of resolution settings, the contrast setting AUTO will appear next to each resolution setting. The second time you move through the list, the contrast setting DARK will appear.

RESOLUTION



JAN-29 01:44
STANDARD :AUTO



JAN-29 01:44
FINE :AUTO



JAN-29 01:44
SUPER FINE :AUTO



JAN-29 01:44
HALF TONE :AUTO



JAN-29 01:44
STANDARD :DARK



JAN-29 01:44
HALF TONE :DARK



Note: In order to transmit in SUPER FINE resolution, the receiving fax machine must also have that resolution. If it doesn't, your machine will automatically step down to the next best available setting.

Changing the default resolution

If desired, you can change the default resolution for faxing documents to FINE. Follow the steps below.

- 1** Press these keys:

FUNCTION



The display will show:

FINE PRIORITY
1=YES, 2=NO

- 2** Press **1** (YES) to set the default resolution to FINE, or **2** (NO) to set it to STANDARD.

YES

NO



or



- 3** Press the **STOP** key to return to the date and time display.

 STOP



Sending a Fax by Normal Dialing

With Normal Dialing, you pick up the handset (or press the **SPEAKER** key) and dial by pressing the number keys.

- ◆ If a person answers, you can talk with them through the handset before sending the fax. (If you pressed the **SPEAKER** key, you must pick up the handset to talk.)
- ◆ Normal Dialing allows you to listen to the line and make sure the other fax machine is responding.

1 Load the document(s). (Note: If desired, you can load the document after dialing in Step 3, below.)

- **SEND READY** appears in the display.
- Set the resolution and/or contrast if desired.

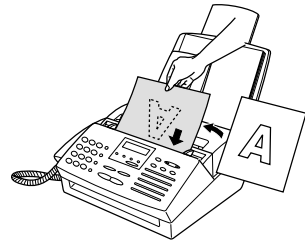

RESOLUTION



2 Pick up the handset or press the **SPEAKER** key. Listen for the dial tone.

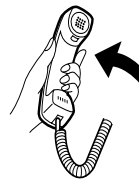

or

SPEAKER



3 Dial the number of the receiving machine by pressing the number keys.



(Example)

4 Wait for the connection. Depending on the setting of the receiving machine, you will either hear a facsimile reception tone or the other person will answer.

- If the other party answers, ask them to press their Start key (if you pressed the **SPEAKER** key, pick up the handset to speak with them). This causes the receiving machine to issue a reception tone.

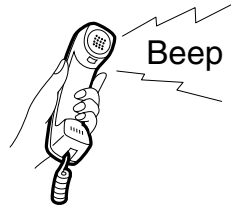

5 When you hear the reception tone, press the **START** key. Replace the handset if you used it.

- When transmission is completed, the fax will beep once.



Using the REDIAL key

You can press the **REDIAL** key to redial the last number dialed. To send a document, press the **START** key when you hear the fax tone after the connection is established. Note that the speaker is automatically activated when you press the **REDIAL** key.

Sending a Fax by Automatic Dialing

You can dial a fax or telephone number by simply pressing a Rapid Key, or by pressing the **SPEED DIAL** key and entering a two-digit number.

To use a Rapid Key or Speed Dial number, you must first program the full fax number in the Rapid Key or Speed Dial number. It is usually convenient to program your most frequently dialed numbers in Rapid Keys.

- ◆ 20 Rapid Keys and 100 Speed Dial numbers are available.
- ◆ You can also store an area code or access code in a Rapid Key or Speed Dial number.
- ◆ You can use a Rapid Key or Speed Dial number to send a fax as an E-mail attachment to an E-mail address. To program a Rapid Key or Speed Dial number for E-mail, see *Programming Rapid Key and Speed Dial Numbers* in Chapter 5 of your online operation guide.

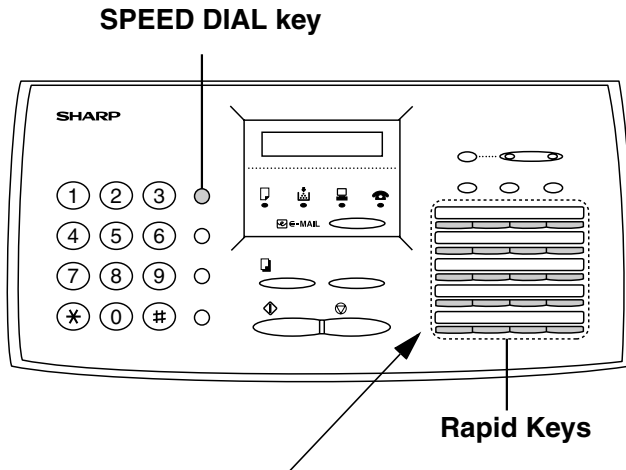

Attach the Rapid Key labels above the Rapid Keys as shown here. When you store a number in a Rapid Key, write the name of the party on the label.

Storing fax and telephone numbers for Automatic Dialing

1 Press these keys:

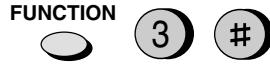

The display will show:

FAX/TEL # MODE
1=SET,2=CLEAR

2 Press the **1** key to select SET.



The display will show:

FAX/TEL # SET
SPEED # OR RAPID

3 To store a number in a Rapid Key, press the desired Rapid Key.



Example:
Rapid Key 01

To store a Speed Dial number, enter the desired 2-digit number (from **00** to **99**) by pressing the number keys.



Example:
Speed Dial 01

4 Enter the fax or voice number by pressing the number keys.
(Note: A space cannot be entered.)

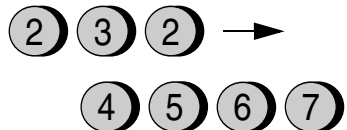

- To clear a mistake, press the **SPEED DIAL** key.

(Example)

- ◆ If a pause is required between any of the digits to access a special service or an outside line, press the **REDIAL** key (two seconds per pause). The pause will appear as a hyphen. Several pauses can be entered in a row.

5 Press the **START** key.



6 Enter the name of the party by pressing the number keys as shown below. (If you don't want to enter a name, go directly to Step 7.)

SPACE = (1) (1)	J = (5) (5)	T = (8) (8)
A = (2) (2)	K = (5) (5) (5)	U = (8) (8) (8)
B = (2) (2) (2)	L = (5) (5) (5) (5)	V = (8) (8) (8) (8)
C = (2) (2) (2) (2)	M = (6) (6)	W = (9) (9)
D = (3) (3)	N = (6) (6) (6)	X = (9) (9) (9)
E = (3) (3) (3)	O = (6) (6) (6) (6)	Y = (9) (9) (9) (9)
F = (3) (3) (3) (3)	P = (7) (7)	Z = (9) (9) (9) (9) (9)
G = (4) (4)	Q = (7) (7) (7)	
H = (4) (4) (4)	R = (7) (7) (7) (7)	
I = (4) (4) (4) (4)	S = (7) (7) (7) (7) (7)	

Example: SHARP = 77777 444 22 7777 ^{SPEAKER} () 77

- ◆ To clear a mistake, press the **SPEED DIAL** key.
- ◆ To enter two letters in succession that require the same key, press the **SPEAKER** key after entering the first letter.
- ◆ To select one of the following symbols, press the # key or the * key repeatedly:
 . / ! " # \$ % & ' () * + , - : ; < = > ? @ [] ^ _ ' { | }

7 Press the **START** key.



- 8** Press **1** if the number programmed is an area code or access code to be used for Chain Dialing (see *Chain Dialing for area and access codes* below). Press **2** (or **START**) if the number is a regular fax or voice number.

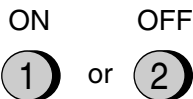

- 9** Return to Step 3 to store another number, or press the **STOP** key to return to the date and time display.



Chain Dialing for area and access codes

You can also program an area code or access code in a Rapid Key or Speed Dial number using the above programming procedure. In Step 8, press **1** to set the number as a Chain Dialing number.

After you dial an area code or access code using a Rapid Key or Speed Dial number set for Chain Dialing, the fax machine will wait for you to dial the remainder of the number (you can dial the remainder of the number by pressing a Rapid Key, by pressing the Speed Dial key and entering a Speed Dial number, or by pressing numeric keys). Note that the remainder of the number should **not be set** as a Chain Dial number if programmed in a Rapid Key or Speed Dial number.

- ◆ The maximum number of digits that can be dialed at one time by Chain Dialing is 50.

Clearing auto-dial numbers

- 1** Press these keys:



The display will show:

FAX/TEL # MODE
1=SET,2=CLEAR

2 Press **2** to select CLEAR.



3 Press the Rapid Key or enter the Speed Dial number (press the number keys) that you want to clear.



Example:
Speed Dial 01

4 Press the **START** key.



5 Return to Step 3 to clear another number, or press the **STOP** key to return to the date and time display.

Step 3 or



Note: You cannot clear a number if it is used in a timer operation or is included in a Group Key. First clear the number from the operation or group, then clear the Rapid Key or Speed Dial number. To check where the number is used, print out the Group List or the Timer List as explained in Chapter 8.

Making changes

To make changes in a number previously stored, repeat the programming procedure. Select the Rapid Key or Speed Dial number for which you want to make changes in Step 3, and then change the number and/or name when they appear in the display in Steps 4 and 6.

Note: The fax machine uses a lithium battery to keep automatic dialing numbers and other programmed data in memory when the power is turned off. Battery power is consumed primarily when the power is off. With the power kept continuously off, the life of the battery is about 5 years. If the battery dies, have your dealer or retailer replace it. Do not try to replace it yourself.

Dual Access

The fax machine features full dual access, which means that you can load a document and dial by automatic dialing even when the fax machine is occupied with another operation. After you dial, your document will be immediately scanned into memory and then transmitted once all previously set operations have been completed.

If more than one document has been scanned into memory for transmission, the documents will be transmitted in the order in which they were scanned.

- ◆ The fax machine can hold approximately 110 pages of average content in memory. Less pages can be held if any pages are scanned using fine or halftone resolution.
- ◆ The maximum number of transmission jobs that can be held at once is 30.
- ◆ The amount of memory currently occupied appears as a percentage (M:00%) in the display.

If the memory becomes full...

If the memory becomes full while a document is being scanned, MEMORY FULL will appear in the display. Press the **START** key or the **STOP** key as follows:

- ◆ Press the **START** key if you want to transmit the pages which have been stored up to that point in memory. The remaining pages will be ejected from the feeder. After transmission, the memory will be cleared and you can transmit the remaining pages. You will also need to transmit the page which was being scanned when the memory filled up.
- ◆ Press the **STOP** key if you want to cancel the entire transmission.

Sending a Fax by Automatic Dialing

If you do not press the **START** key or the **STOP** key within one minute, the transmission will be canceled and the pages already scanned cleared from memory. You will need to retransmit all pages of the document.

Rapid Key Dialing

If the number you want to dial has been programmed in a Rapid Key, you can dial it by pressing the Rapid Key.

1 Load the document(s).

- **SEND READY** appears in the display.
- Set the resolution and/or contrast if desired.

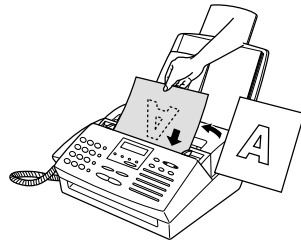

RESOLUTION



2 Press the appropriate Rapid Key.

- The document is automatically transmitted once the connection is established.

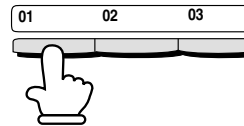

(Example)

Speed Dialing

If the number you want to dial has been programmed in a Speed Dial number, you can dial it by pressing the **SPEED DIAL** key and then entering the Speed Dial number.

1 Load the document(s).

- SEND READY appears in the display.
- Set the resolution and/or contrast if desired.

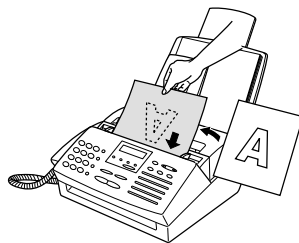

RESOLUTION



2 Press the **SPEED DIAL** key and then enter the Speed Dial number by pressing the numeric keys.

- To enter numbers 1 through 9, first enter 0 and then the number.

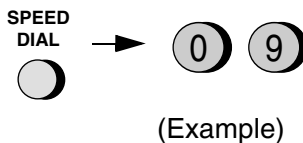

3 Check the display. If the name or number shown is correct, press the **START** key. (If not, press the **STOP** key and then repeat Step 2.)



Direct Keypad Dialing

You can also enter a full number with the number keys and then press the **START** key to begin dialing. You can use this method to dial a full number when you don't need to speak to the other party before faxing.

1 Load the document(s). (Note: If desired, you can load the document after dialing in Step 2, below.)

- SEND READY will appear in the display.
- Set the resolution and/or contrast if desired.

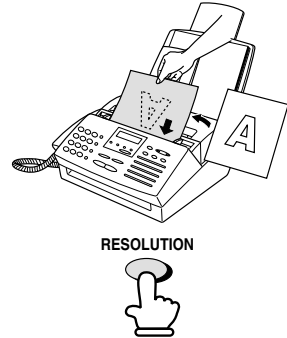

2 Enter the number of the receiving machine by pressing the numeric keys.

- If a pause is required between any of the digits to access a special service or an outside line, press the **REDIAL** key (two seconds per pause). The pause will appear as a hyphen. Several pauses can be entered in a row.

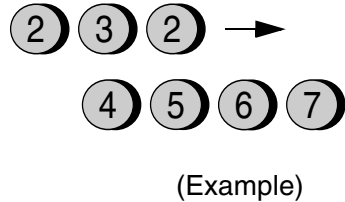

3 Check the display. If the number of the receiving machine shown is correct, press the **START** key.

- If it is not correct, press the **STOP** key to backspace and clear one digit at a time, and then re-enter the correct digit(s).



Searching for an auto-dial number

If you don't remember the Rapid Key or Speed Dial number in which you have programmed a particular fax number or E-mail recipient, you can search for the number by following the steps below. Once you have found the number, you can dial and transmit the loaded document by simply pressing the **START** key. (Note: To search for an E-mail recipient, your fax must be connected to your computer.)

1 Load the document(s).

- SEND READY will appear in the display.
- Set the resolution and/or contrast if desired.

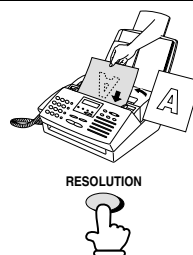

2 Press the **HOLD/SEARCH** key.



3 Press **1** to search for an auto-dial number, or **2** to search for an E-mail recipient.

AUTO-DIAL E-MAIL

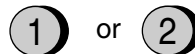

4 Enter the first letter of the stored name by pressing the appropriate number key (the key below the marked letter) one or more times until the letter appears in the display. If the name begins with a special character or number, press **1** (only for auto-dial numbers).

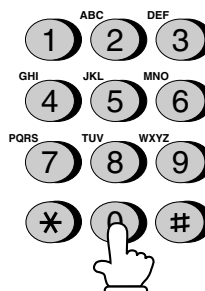

- ◆ If you don't remember the first letter, go to Step 5 (you will scroll through the list from the beginning).
- ◆ If a name wasn't stored (for an auto-dial number), press **0**. This will cause numbers, not names, to appear when you scroll.

5 Press the # key or the * key to scroll through the names (numbers if you pressed 0). Stop when the desired name appears in the display.

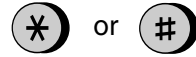

- If no names have been stored that begin with the entered letter, you will scroll from the next name, in alphabetical order, in the list. If no names/numbers have been stored at all, NO DATA will appear.

6 Press the **START** key.



- The document is transmitted.

Automatic redialing

If you use automatic dialing (including Direct Keypad Dialing) and the line is busy, the fax machine will automatically redial the number. The fax machine will make up to two redialing attempts at an interval of five minutes.

- ◆ To stop automatic dialing, cancel the job as explained in Checking and cancelling transmission jobs in Chapter 2.

Recall Interval for automatic redialing

If desired, you can change the interval at which the fax machine makes automatic redialing attempts.

1 Press these keys:

FUNCTION



The display will show:

RECALL INTERVAL ENTER (01-15) 05

- 2** Enter a 2-digit number from **01** to **15** for the number of minutes of the interval.



Example:
3 minutes

- 3** Press the **STOP** key to return to the date and time display.



Recall times for automatic dialing

If desired, you can change the maximum number of automatic redialing attempts made when the line is busy.

- ◆ Under certain conditions (for example if a person answers the call on a telephone), automatic redialing may stop before the set number of redialing attempts are made.

- 1** Press these keys:

FUNCTION



The display will show:

RECALL TIMES
ENTER (00-10) (02)

- 2** Enter a 2-digit number from **00** to **10** for the maximum number of redial attempts.



Example:
5 attempts

- 3** Press the **STOP** key to return to the date and time display.



Checking and cancelling transmission jobs

To display information on currently set transmission (and polling) jobs, follow the steps below. You can also cancel a job with this procedure.

1 Press these keys.

- The display will show **ACTION STATUS** and the number of transmission jobs, and then information on the first job.



2 Press the **UP** key or the **DOWN** key to scroll through the list of jobs. (Note: You can also scroll with the *** / #** key.)

- The display will show the 2-digit memory number assigned to the transmission, the time the transmission was set, and status of the job alternating with the name (or number) of the receiving party.
- To cancel a job, press the **START** key twice while the job appears in the display.

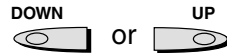

3 When you have finished viewing the list, press the **STOP** key to return to the date and time display.



Error Correction Mode

The fax machine is set to automatically correct any distortions in a transmission due to noise on the telephone line before printing at the receiving end. This function is called Error Correction Mode (ECM). ECM is effective for both transmissions and receptions, and is only effective when the other fax machine also has ECM.

1 Press these keys:

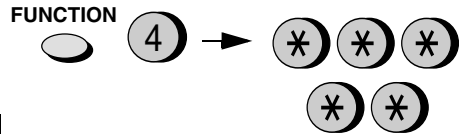

The display will show:

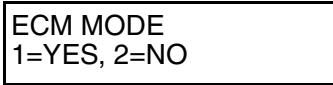

2 Press **1** to turn on ECM or **2** to turn it off.

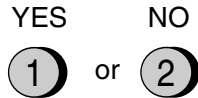

3 Press the **STOP** key to return to the date and time display.



Quick Online

When you transmit a document, the fax machine normally dials the receiving party and begins transmitting while scanning is still in progress. This function is called Quick Online. If desired, you can turn off Quick Online and have the fax machine wait until all pages have been scanned before dialing.

1 Press these keys:

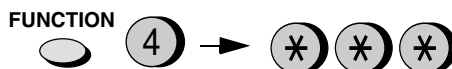

The display will show:

QUICK ON-LINE
1=YES, 2=NO

2 Press **1** to turn on Quick Online or **2** to turn it off.

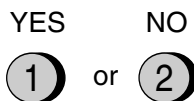

3 Press the **STOP** key to return to the date and time display.



3. Receiving Documents

Using FAX Mode

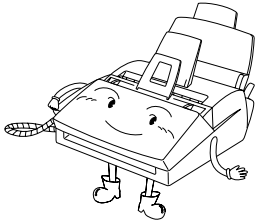

To select FAX mode, press the **RECEPTION MODE** key until the arrow in the display points to FAX.

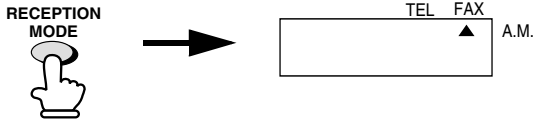

When the reception mode is set to FAX, the fax machine will automatically answer all calls on four rings and receive incoming faxes.

4 rings

Fax reception

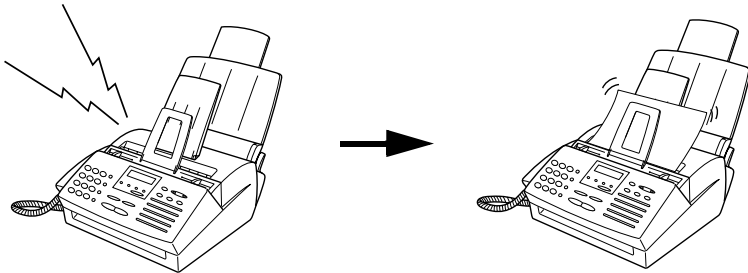

- ◆ If you pick up the handset before the machine answers, you can talk to the other party and/or receive a document as explained in *Using TEL mode*.

Changing the number of rings

If desired, you can change the number of rings on which the fax machine answers incoming calls in FAX mode. Any number from 1 to 5 can be selected.

- 1** Press these keys:

FUNCTION



The display will show:

NUMBER OF RINGS
ENTER (1-5) (4)

- 2** Enter the desired number of rings
(any number from **1** to **5**).



The display will briefly show your
selection, and then:

Example: 3 rings

RECALL INTERVAL
ENTER (01-15) 05

- 3** Press the **STOP** key to return to the
date and time display.



Note: If you are using Distinctive Ring, the fax machine will answer calls after two rings regardless of the above setting.

Received document outlet

Note: The received document outlet has a maximum capacity of 100 sheets. To prevent the outlet from becoming obstructed, which will in turn cause paper jams, be sure to frequently remove received documents and copies. **Do not allow a large number of documents to accumulate in the outlet.**

Using TEL Reception Mode



To select TEL mode, press the **RECEPTION MODE** key until the arrow in the display points to TEL.

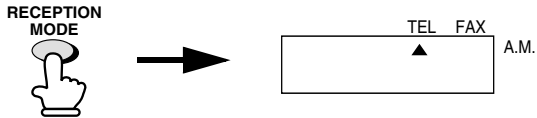

When the reception mode is set to TEL, you must answer all calls by picking up the fax machine's handset or an extension phone connected to the same line.

Answering with the fax's handset

- 1 When the fax machine rings, pick up the handset.

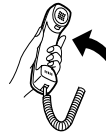

- 2 If you hear a fax tone, wait until the display shows RECEIVING and then replace the handset.

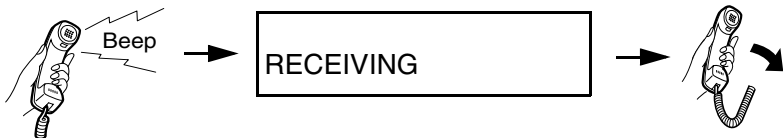

Note: If you have set the Fax Signal Receive setting to NO, press the **START** key to begin reception.

3 If the other party first speaks with you and then wants to send a fax, press the **START** key after speaking. (Press your **START** key before the sender presses their Start key.)

- When RECEIVING appears in the display, hang up.

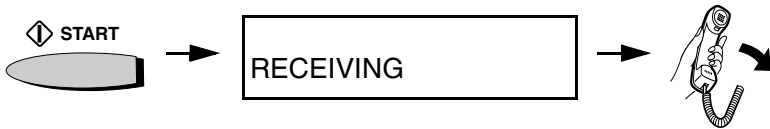

Answering with an extension phone

1 Answer the extension phone when it rings.

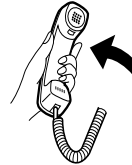

2 If you hear a soft fax tone, wait until your fax responds (the extension phone will go dead if it is connected to your fax, or you will hear pronounced, high-pitched tones if the phone is connected to a separate wall jack), then hang up.

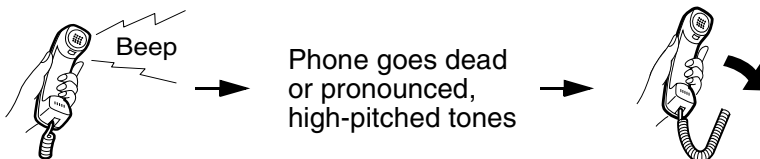

- 3** If the fax doesn't respond, or if the other party first talks to you and then wants to send a fax, press **5**, *****, and ***** on the extension phone (only on a tone dial phone). This signals the fax to begin reception. Hang up.

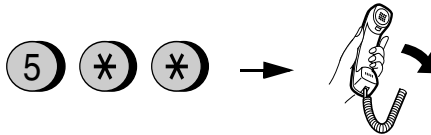

Comments:

- ◆ Your fax will not accept the signal to begin reception (**5****) if a document is loaded in its feeder.
- ◆ If you have set the Fax Signal Receive setting to NO, press **5**, *****, and ***** on the extension phone to begin reception.

Changing the number for remote fax activation

If desired, you can use a number other than **5** to activate fax reception from an extension telephone. You can select any number from **0** to **9**.

- 1** Press these keys:

FUNCTION



4



#

#

#

The display will show:

TEL/FAX REMOTE #
ENTER (0-9) (5)

#

#

#

- 2** Enter a number from **0** to **9**.

1

(Example)

-
- 3** Press the **STOP** key to return to the date and time display.



Turning off detection of the Tel/Fax Remote Number

If you don't intend to ever activate fax reception from an extension phone, you can turn off detection of the above TEL/FAX REMOTE NUMBER. This will ensure that the fax never mistakenly attempts to begin reception if it detects a signal similar to the TEL/FAX REMOTE NUMBER while you are talking on an extension phone.

-
- 1** Press these keys:

FUNCTION

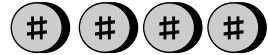

The display will show:

REMOTE RECEPTION
1=YES, 2=NO

-
- 2** Press **1** to turn on detection of the TEL/FAX REMOTE NUMBER, or **2** to turn it off.

YES

NO



or



-
- 3** Press the **STOP** key to return to the date and time display.



Fax Signal Receive

Your fax will automatically begin reception if you hear a soft fax tone after answering a call on your fax or an extension phone. If you use a computer fax modem to send documents on the same line, you must turn this function off in order to prevent your fax from mistakenly attempting to receive documents from the computer fax modem. Follow the steps below to change the setting.

1 Press these keys:

FUNCTION



4

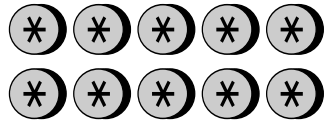

The display will show:

FAX SIGNAL RX
1=YES, 2=NO

2 Press **1** to turn on the function, or **2** to turn it off.

YES

NO

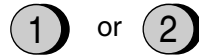

3 Press the **STOP** key to return to the date and time display.



Reception Ratio

The fax has been set at the factory to automatically reduce the size of received documents to fit the size of the printing paper. This ensures that data on the edges of the document are not cut off. If desired, you can turn this function off and have received documents printed at full size.

- ◆ If a document is too long to fit on the printing paper, the remainder will be printed on a second page. In this case, the cut-off point may occur in the middle of a line.
- ◆ Automatic reduction may not be possible if the received document is too large, contains too many fine graphics or images, or is sent at high resolution. In this case, the remainder of the document will be printed on a second page.

1 Press these keys:

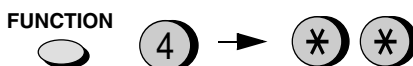

The display will show:

RECEPTION RATIO
1=AUTO, 2=100%

2 Press **1** to turn on automatic reduction, or **2** to turn it off.

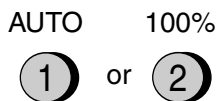

3 Press the **STOP** key to return to the date and time display.



Substitute Reception to Memory

In situations where printing is not possible, such as when your fax runs out of paper, the toner cartridge needs replacement, or the paper jams, incoming faxes will be received to memory.

When you have received a document in memory, CAN'T PRINT DATA will appear in the display, alternating with a message indicating the problem. When you correct the problem, the stored documents will automatically print out.

If you received documents in memory because the fax ran out of paper, be sure to add paper which is the same size as the paper previously used. If not, the document print-out size may not match the size of the printing paper.

Caution!

- ◆ When documents are stored in memory, do not turn the power off. This will erase all of the contents.
- ◆ If documents received in memory are lost due to a power failure or other interruption in the power supply, a CLEAR REPORT will be printed out when the power is restored. This gives information about the receptions lost, including the fax numbers of the transmitting machines if they are available.

4. Making Copies

Your fax can also be used to make copies. Single and multiple copies (up to 99 per original) can be made, enabling your fax to double as a convenience office copier.

- 1** Load the document(s) face down.
(Maximum of 20 pages.)

- SEND READY appears in the display.

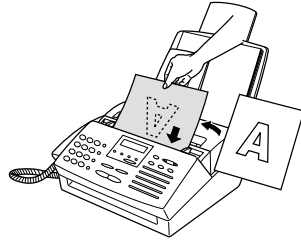

- 2** If desired, select one or more of the following optional copy settings:

• **SORT COPY:**

If you are making multiple copies of more than one original and want the copies sorted, press the **FUNCTION** key and **6**, and then enter the number of copies per original. (If the number of copies is less than ten, enter a “0” before the number.)

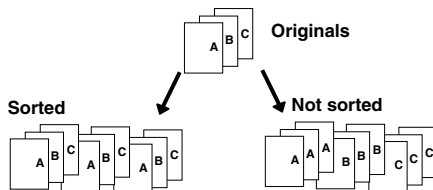
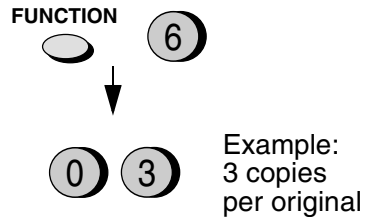

Example of sorted/not-sorted copies (three each) of three originals

• **MULTIPLE COPIES**

(Not sorted):

If you want to make multiple copies of the original (or each original), enter a 2-digit number for the number of copies per original. (If the number is less than 10, do not enter a 0 before the number.)



Example: Nine copies per original

• **REDUCE/ENLARGE:**

If you want to reduce or enlarge the copy, press the **REDUCTION/ENLARGEMENT** key until the desired percentage appears in the display (you can also scroll through the percentages with the UP and DOWN keys). The selections are as follows:



100% (no reduction/enlargement)

AUTO (auto reduction to fit the size of the printing paper.)

94%

88%

73%

50%

200%

150%

125%

Note: The enlargement/reduction setting is effective for one time only.

• **RESOLUTION:**

If desired, set the resolution and/or contrast. (The default setting for copying is FINE.)



3 Press the **COPY/HELP** key.

- Copying begins.



Note:

If you place a large number of originals in the feeder, the memory may become full before all of them can be scanned (MEMORY IS FULL will appear in the display). If this happens, press the **START** key to copy the originals which have been scanned, and then repeat the copy procedure for the remaining originals, including the original which was being scanned when the memory became full.

Copy Cut-off

When making a copy of a document that is longer than the printing paper, use the copy cut-off setting to select whether the remaining part of the document will be cut off or printed on a second page. The initial setting is YES (cut off the remainder). To change the setting, follow the steps below.

-
- 1** Press these keys:



The display will show:

COPY CUT-OFF
1=YES, 2=NO

-
- 2** Press **1** to set copy cut-off to YES (the remaining part of the document will not be printed), or **2** to set copy cut-off to NO (the remaining part will be printed on a second page).

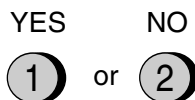

The display briefly shows your selection, and then:

PAPER SIZE
1=LETTER, 2=LEGAL

-
- 3** Press the **STOP** key to return to the date and time display.



5. Making Telephone Calls

Your fax machine can be used like a regular telephone to make and receive voice calls.

- ◆ To make or receive a voice call, the power must be on.

-
- 1** Pick up the handset or press the **SPEAKER** key. Listen for the dial tone.

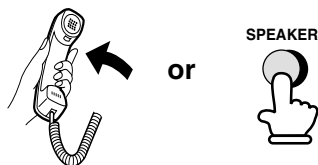

-
- 2** Dial the number using one of the following methods:

- **Normal Dialing:** Enter the full telephone number with the numeric keys.
- **Rapid Key Dialing:** Press the appropriate Rapid Key.
- **Speed Dialing:** Press the **SPEED DIAL** key, and enter the 2-digit Speed Dial number with the numeric keys.

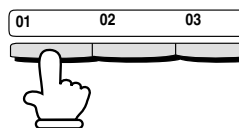

Example: Press Rapid Key 01

-
- 3** Speak with the other party when they answer.

- If you pressed the **SPEAKER** key, pick up the handset to talk.



Comments:

- ◆ While the handset of the fax is lifted (off hook), an extension phone connected directly to the fax cannot be used to speak with the other party.
- ◆ The fax may interrupt a voice call received on an extension phone if the reception mode is set to A.M. and there is a period of silence during the conversation. If you are on a touch-tone phone, you can prevent this by pressing any three keys on the phone immediately after you answer. (Note: Do not enter the code to activate fax reception: 5, *, *.)

Searching for an auto-dial number

You can use the **HOLD/SEARCH** key to search for a Rapid Key or Speed Dial number. First search for the number as described in *Searching for an auto-dial number in Sending a Fax by Automatic Dialing* in Chapter 2, then pick up the handset or press the **SPEAKER** key. The number will be dialed automatically (do not press the **START** key).

Redial

The last number dialed can be redialed by pressing the **REDIAL** key (it is not necessary to pick up the handset or press the **SPEAKER** key). When the other party answers, pick up the handset to talk.

Hold

You can put the other party on hold during a conversation by pressing the **HOLD/SEARCH** key. When this is done, they cannot hear you. You can put the handset back in the cradle without breaking the connection. When you are ready to speak with them again, pick up the handset. If you did not put the handset back in the cradle, press the **HOLD/SEARCH** key again to resume conversation.

6. Answering Machine Hookup

Connecting an Answering Machine

If desired, you can connect an answering machine to your fax machine's **TEL. SET** jack. This will allow you to receive both voice messages and faxes when you are out.

-
- 1 Remove the seal covering the **TEL. SET** jack.

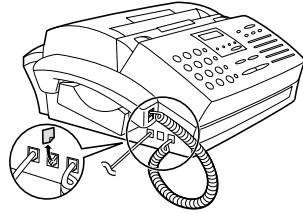

- 2 Connect the answering machine's telephone line jack to the **TEL. SET** jack.

- If desired, you can connect an extension phone to your answering machine's extension phone jack.

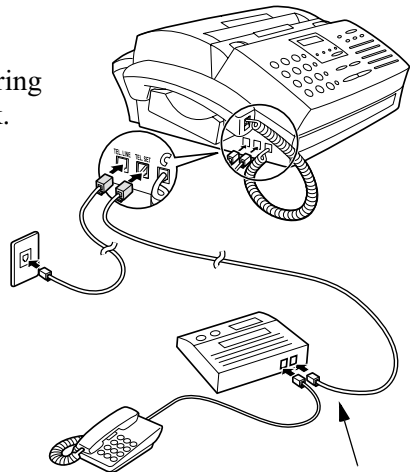

Make sure the **TEL. LINE** jack is connected to the wall jack.

To answering machine's telephone line jack.

Changing the outgoing message

The outgoing message (OGM) of your answering machine should be changed to inform callers who want to send a fax to press their Start key. For example, your message might go as follows:

“Hello. You've reached the ABC company. No one is available to take your call right now. Please leave a message after the beep or press your facsimile Start key to send a fax. Thank you for calling.”

- ◆ Try to keep the length of the message under 10 seconds. If it is too long, you may have difficulty receiving faxes sent by automatic dialing.
- ◆ If your outgoing message must be longer than 10 seconds, leave a pause of about four seconds at the beginning of the message. This will give your fax a chance to detect fax tones sent when automatic dialing is used.

Activating the answering machine connection

Before you go out, activate the answering machine connection as follows:

-
- 1** Set the reception mode to A.M.

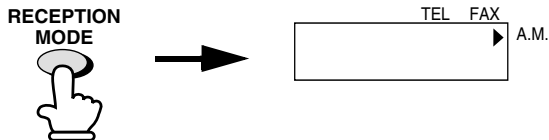

2 Set your answering machine to auto answer.

- ◆ Your answering machine must be set to answer on a maximum of two rings. If not, you may not be able to receive faxes sent by automatic dialing.
- ◆ If your answering machine has a toll saver function, make sure that it will answer by the fourth ring.

Note:

If your answering machine has a remote retrieval function, make sure the code used to activate remote retrieval is different from the code used to activate fax reception with an extension telephone (see Chapter 3, Receiving Documents). If they are the same, entering the code from an outside telephone to retrieve messages will cause the fax machine to be activated.

How the connection operates

While you are out, all of your incoming calls will be answered by your answering machine and its outgoing message will play. Voice callers can leave a message. During this time, your fax will quietly monitor the line. If your fax detects a fax tone or a duration of silence greater than four seconds, it will take over the line and begin reception.

When you return and turn off your answering machine, be sure to change the reception mode back to FAX or TEL!

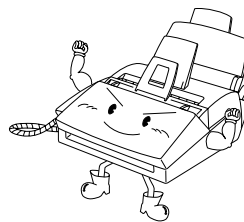

Optional A.M. Mode Settings

If necessary, you can use the following settings to improve the response of the answering machine hookup to incoming calls.



Quiet Detect Time

The fax machine is set to take over the line and begin reception if it detects 4 seconds of silence after the answering machine answers. If needed, you can change this setting to any number of seconds from 1 to 10.

- ◆ We recommend that you do not set Quiet Detect Time under 3 seconds.
- ◆ If the fax machine is interrupting callers before they can leave a message, try a longer Quiet Detect Time setting. If your outgoing message includes a period of silence, make sure that the setting is longer than that period of silence, or re-record your outgoing message to shorten the silence.

Note:

Quiet Detect Time can be turned off by entering “00” for the time. Note, however, that the fax machine may not be able to receive manually-sent faxes from some older fax machines.

1 Press these keys: **FUNCTION**  **4** → 

The display will show:

QUIET DETECT TM.
ENTER (00-10) 04

-
- 2** Enter a number from **01** to **10**, or enter **00** to turn off the function.



(Example)

- 3** Press the **STOP** key to return to the date and time display.







Fax when Answering machine Fails

When this function is turned on, your fax will answer the call after 5 rings if the answering machine for some reason fails to answer before that time. This ensures that you will receive fax messages even if the answering machine's tape fills up or the answering machine is not turned on.

This function has been turned off at the factory. If you want to turn it on, follow the steps below:

Note:

When this function is turned on, make sure that the answering machine is set to answer on 4 rings or less. If it isn't, the fax will always answer first, preventing callers from leaving voice messages.

- 1** Press these keys: **FUNCTION**  **4**   

The display will show:

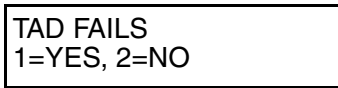

- 2** Press **1** to turn on the function, or **2** to turn it off.
- YES **1** or NO **2**

- 3** Press the **STOP** key to return to the date and time display.



7. Special Functions

Broadcasting

The Broadcasting function allows you to send the same document to as many as 30 different locations with just one operation. First load the document, then enter the numbers of the receiving machines. The document will be automatically transmitted to each location.

- ◆ You can only use Rapid Keys or Speed Dial numbers to dial the numbers of the receiving machines.

1 Load the document (s).

- SEND READY will appear in the display.

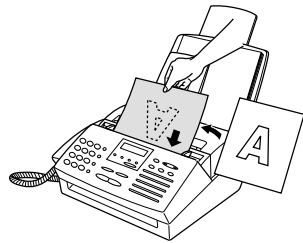

2 Press the **BROADCAST** key.

The display will show:

BROADCAST MODE
SPEED # OR RAPID

BROADCAST



3 Dial the receiving machines using one or more of the following methods:

- Press one or more Rapid Keys.
- Enter one or more Speed Dial numbers with the numeric keys.

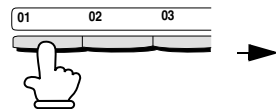

(Example)

4 Press the **START** key.

The display will show:

SET RESOLUTION
PRESS RESO. KEY

- If desired, adjust the resolution and/or contrast.



RESOLUTION



5 Press the **START** key. Transmission begins.

- A Transaction Report is automatically printed out after Broadcasting is completed. Check the “Note” column of the report to see if any of the locations are marked “Busy” or have a communication error code. If so, send the document to those locations again.



Broadcasting using a Group Key

If the fax machines to which you want to broadcast have all been programmed into one Group Key (see *Storing numbers in Group Keys* which follows), you can perform the broadcasting operation using the following simplified procedure:

- 1 Load the document(s).
 - SEND READY will appear in the display.
 - If desired, adjust the resolution and/or contrast.

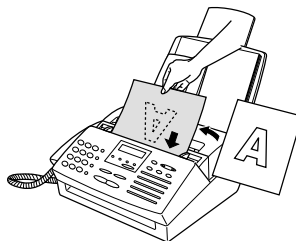

RESOLUTION



- 2 Press the appropriate Group Key.
Transmission will begin.

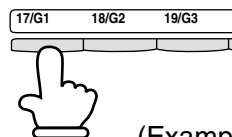

(Example)

Storing numbers in Group Keys

Group Keys allow you to dial a group of fax numbers by simply pressing the appropriate Group Key once. To store a group of numbers in a Group Key, follow the steps below.

Rapid Keys 17/G1 through 20/G4 can be used as Group Keys. Note that one key cannot be simultaneously programmed as both a Group Key and a Rapid Key.

- ◆ Up to 30 numbers can be stored in one Group Key.
- ◆ Only Rapid Key and Speed Dial numbers (excluding numbers set for Chain Dialing) can be stored in a Group Key. Full numbers cannot be stored.

1 Press these keys.



The display will show:

GROUP ENTRY MODE
1=SET, 2=CLEAR

2 Press **1** (SET) to program a Group Key, or **2** (CLEAR) to clear a Group Key.

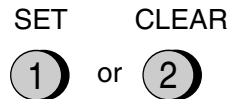

3 To program a Group Key, press the key you want to program (one of Rapid Keys 17/G1 to 20/G4).

To clear a Group Key, press the key you want to clear and go to Step 5.

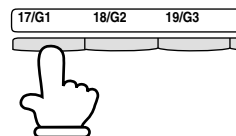

(Example)

4 Enter fax numbers using one or both of the following methods:

- Press one or more Rapid Keys.
- Enter one or more Speed Dial numbers with the numeric keys.

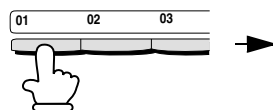

(Example)

5 Press the **START** key.



6 Return to Step 3 to program another Group Key, or press the **STOP** key repeatedly until you return to the date and time display.



Distinctive Ring (Requires Subscription to Service)

Important:

- ◆ **To use distinctive ring, you must subscribe to a distinctive ring service from your local phone company.**
- ◆ Your fax machine may not be compatible with some distinctive ring services.

Distinctive ring is a service offered by some local telephone companies whereby they assign an additional second number to your regular single line. The second number rings differently from your normal number.

If you subscribe to a distinctive ring service, you can set the fax machine to automatically answer when your second number is called. This allows you to use the second number as an exclusive fax number.

To have your fax automatically answer when your second number is called, follow the steps below:

1 Press these keys:

FUNCTION



The display will show:

OPTION SETTING
PRESS * OR #

2 Press the * key 11 times.

The display will show:

DISTINCTIVE RING
1:RING PATTERN 1

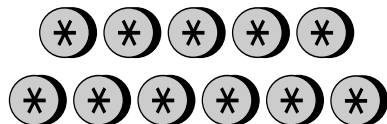

The ring pattern selections alternately appear here.

3 Press a number from **1** to **3** to select the ring pattern below that matches your second number's ring pattern. Or, press **4** to have your fax automatically answer your normal telephone number. Press **5** to turn off the distinctive ring function.

- | | | |
|----------|----------------|---|
| 1 | RING PATTERN 1 | Two short rings |
| 2 | RING PATTERN 2 | One short, one long, and one short ring |
| 3 | RING PATTERN 3 | Two short rings and one long ring |
| 4 | STANDARD RING | Your standard (normal) ring pattern |
| 5 | OFF SETTING | Turn distinctive ring off |

The display will briefly show your selection, and then:

FAX SIGNAL RX
1=YES, 2=NO

4 Press the **STOP** key to return to the date and time display.



5 Set the reception mode to FAX.

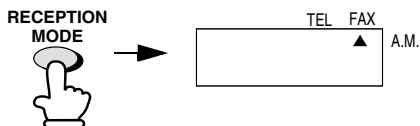

- ◆ When using distinctive ring, you must set the reception mode of your fax machine to FAX. When your designated fax number is dialed, your fax will automatically answer and begin reception after two rings. Note that other devices on the same line will also ring until your fax answers. If one of your other numbers is dialed, the fax will ring; however, it will not answer.

Cover Sheet

You can have the fax generate a cover sheet and send it as the last page of each of your fax transmissions.

You can select a message.

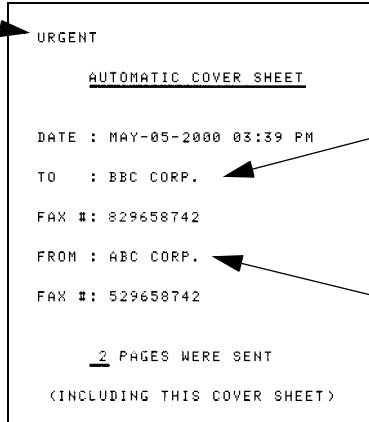

For the recipient's name to appear, you must dial using a Speed Dial or Rapid Key number with the name programmed.

Your name and number must be programmed as explained in Chapter 1.

Follow the steps below to turn on the cover sheet function. Once the cover sheet function is turned on, cover sheets will be included with all transmissions until you turn it off.

1 Press these keys:

FUNCTION



The display will show:



COVER SHEET
1=YES, 2=NO

- 2** Press **1** (YES) to turn on the cover sheet function, or **2** (NO) to turn it off.

YES NO
 1 or **2**

The display will briefly show your selection, and then:

AUTO PRINT OUT
1=YES, 2=NO

- 3** Press the **STOP** key to return to the date and time display.



Selecting a header message (optional)

When the cover sheet function is turned on, you can also select a message which will appear as a header at the top of the cover sheet. Note that the message selection is only effective for one transmission.

- 1** Load the document(s).
- The document must be loaded before a message can be selected.
 - The cover sheet function must be turned on.

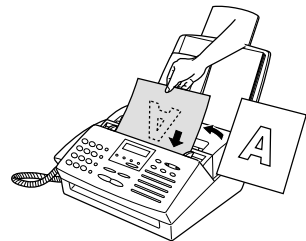

- 2** Press these keys:

FUNCTION **5**

The display will show:

COVER SHEET HEAD
1=URGENT

The message selections alternately appear here.

- 3** Select a message by entering a number from **1** to **4**:



(Example)

- 1: URGENT
 - 2: IMPORTANT
 - 3: CONFIDENTIAL
 - 4: PLS. DISTRIBUTE
-

- 4** Dial the receiving machine and transmit the document.

Note:

To cancel a header message selection, press the **STOP** key or remove the document from the feeder.

Batch Page Numbering

You can change the page numbering of the fax from simple numbering (“P.01”, “P.02”, etc.) to batch numbering, which means that a slash and the total number of pages are added after each page number (for example, “P. 01/05”, “P.02/05”, etc.). This allows the recipient to check for missing pages.

1 Load the document(s).

- The document must be loaded before batch page numbering can be set.

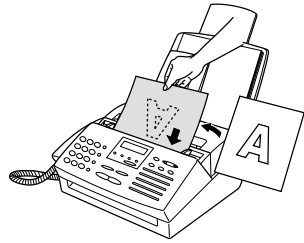

2 Press these keys:

The display will show:

PAGE COUNTER SET
ENTER # (01-99)

FUNCTION



3 Enter the total number of pages (“01” to “99”) by pressing the number keys. (If the number is less than 10, enter a “0” before the number.)

- If you are sending a cover sheet, **do not** include it in the total number of pages (the number will be adjusted automatically).

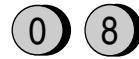

Example:
Eight pages

- 4** Dial the receiving machine and transmit the document.

Comments:

- ◆ If you need to cancel a batch number entry, remove the document from the feeder or press the **STOP** key.
- ◆ If the number of pages actually transmitted does not coincide with the batch number entered, the alarm will sound and **PAGE COUNT ERROR** will appear in the display. **PAGE E.** will also appear in the **NOTE** column of the Transaction Report if it has been set to print out.

Blocking Reception of Unwanted Faxes

The Anti Junk Fax function allows you to block reception of faxes from parties which you specify. This saves paper by not printing out unwanted “junk” faxes.

To use this function, follow the steps below to turn it on, and then enter the fax numbers from which you do not want to receive faxes as indicated in the procedure that follows.

- 1** Press these keys:

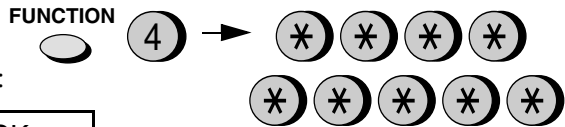

The display will show:

JUNK FAX # CHECK
1=YES, 2=NO

- 2** Press **1** to turn on the Anti Junk function, or **2** to turn it off.

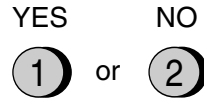

- 3** Press the **STOP** key to return to the date and time display.



Entering Anti Junk numbers

Enter (or clear) a number in the Anti Junk List as shown below. Up to five numbers can be entered.

- ◆ To clear a number from the Anti Junk Number List, you need to know the 1-digit number which identifies it. If you have forgotten this number, print out the Anti Junk Number List as explained in Chapter 8.

1 Press these keys:



The display will show:

STORE JUNK FAX #
1=SET, 2=CLEAR

2 Press **1** to enter a number in the Anti Junk Number List, or **2** to clear a number from the list.

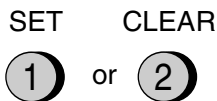

3 **Entering:** Enter a 1-digit number from **1** to **5** with the numeric keys. This number identifies the fax number that you will enter in the next step.



(Example)

Clearing: Enter the 1-digit number that identifies the fax number you want to clear, and go to Step 5.

4 Enter the fax number.



(Example)

5 Press the **START** key.



6 Return to Step 3 to enter (or clear) another fax number, or press the **STOP** key to return to the date and time display.



Polling (Requesting a Fax Transmission)

Polling allows you to call another fax machine and have it send a document to your machine without operator assistance. In other words, the receiving fax machine, not the transmitting fax machine, initiates the transmission. You can use your fax machine to both poll and be polled by others.

To use the polling function, you must first set Rapid Key 16/POLL for use as a polling key.

- 1** Press these keys:

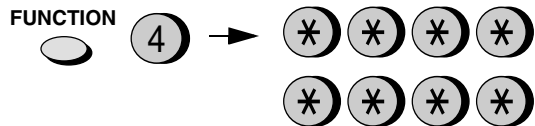

The display will show:

POLLING
1=YES, 2=NO

- 2** Press **1** to turn on the function, or **2** to turn it off.

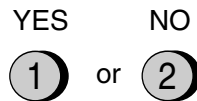

- 3** Press the **STOP** key to return to the date and time display.



Note: When Rapid Key 16/POLL is set as a polling key, it cannot be used for Rapid Key dialing.

Requesting transmission

1 Dial the fax machine you want to poll using one of the following methods:

- Pick up the handset (or press the **SPEAKER** key) and dial the full number. Wait for the fax answerback tone.
- Pick up the handset (or press the **SPEAKER** key) and press the Rapid Dial Key. Wait for the fax answerback tone.
- Press the **SPEED DIAL** key and enter a 2-digit Speed Dial number.

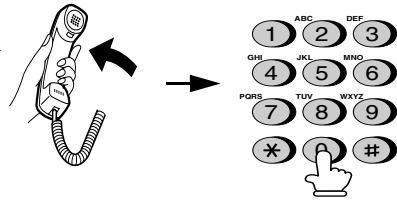

(Example)

- Enter the full number using the numeric keys.

2 Press Rapid Key 16/POLL.

- If you used the handset, replace it when POLLING appears in the display. Reception will begin.

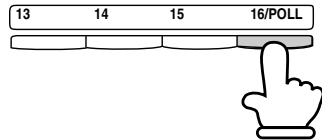

Being polled (Memory polling)

To let another fax machine poll your fax machine, you must first store the document in memory using the following procedure. Transmission will take place when the other fax machine calls your fax machine and activates polling. You can choose whether to allow polling only once, or an unlimited number of times. In the latter case, your fax machine can be used as an electronic "bulletin board".

- ◆ Only one document can be stored at a time for memory polling.
- ◆ If you allow polling only once, the document will be automatically cleared from memory after polling. If you allow polling an unlimited number of times, the document will remain in memory until you clear it as explained in the following section, *Clearing a document*.

-
- 1** Load the document.

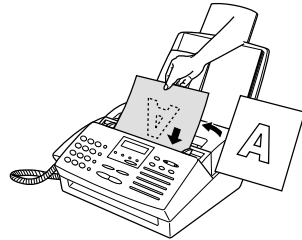

-
- 2** Press the **RECEPTION MODE** key to set the reception mode to FAX.

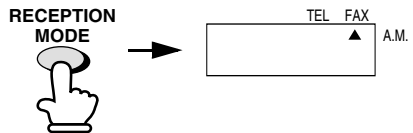

-
- 3** Press these keys:



The display will show:

MEMORY POLL MODE
1=SET, 2=CLEAR

4 Press **1** to select SET.



5 Press **1** to allow polling only once, or **2** to allow polling an unlimited number of times.

ONCE REPEAT

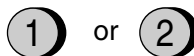

6 Press the **START** key.

- The document is scanned into memory and your fax goes on polling standby.



Clearing a document

To clear a memory poll document from memory, follow the steps below:

1 Press these keys:

FUNCTION



The display will show:

MEMORY POLL MODE
1=SET, 2=CLEAR

2 Press **2** to select CLEAR.



3 Press the **START** key to clear the document, and then the **STOP** key to return to the date and time display.

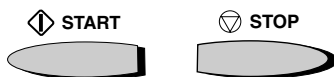

Polling security

Polling Security allows you to prevent unauthorized polling of your machine. When this function is turned on, polling will only take place when the fax number of the polling fax machine has been entered in your machine's list of permitted fax numbers (called "passcode numbers"). The number of the polling fax must also be correctly programmed into itself for identification.

To use Polling Security, follow the steps below to turn the function on, and then enter permitted numbers as shown on the following page.

- 1** Press these keys:

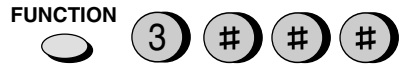

The display will show:

SECURITY SELECT
1=ON, 2=OFF

- 2** Press **1** to turn polling security on, or **2** to turn it off.

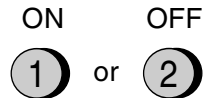

- 3** Press the **START** key and then the **STOP** key.

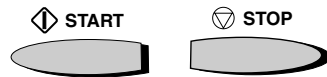

Storing and clearing fax numbers for polling permission

You can store up to 10 fax numbers in your machine's list of permitted numbers.

1 Press these keys:



The display will show:

PASSCODE # MODE
1=SET, 2=CLEAR

2 Press **1** to store a number, or **2** to clear a number.

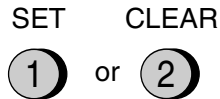

3 Storing: Enter a 2-digit number from 01 to 10. This number identifies the fax number you will store in the next step.



(Example)

Clearing: Enter the number which identifies the fax number you want to clear, and go to Step 5.

4 Enter the fax number.



(Example)

5 Press the **START** key.



6 Return to Step 3 to enter (or clear) another number, or press **STOP** to return to the date and time display.



Timer Operations

The Timer function allows you to set up a transmission or polling operation to be performed automatically at a time you specify. Up to three operations can be set at any one time, and the times they will be performed can be specified up to one week in advance.

- ◆ You can use this function to take advantage of lower off-peak telephone rates without having to be there when the operation is performed.

Note: Only a Rapid Key or Speed Dial number can be used to dial the receiving machine. Full numbers cannot be used.

Setting a timer operation

-
- 1 If this is a transmission, load the document.

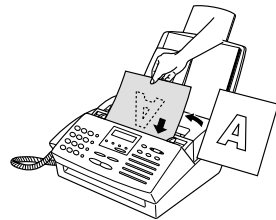

-
- 2 Press these keys:

The display will show:

TIMER MODE
1=SET, 2=CLEAR

FUNCTION



-
- 3 Press 1 to select SET.



-
- 4 Press 1 to set a transmission operation (SEND MODE), or 2 to set a polling operation (POLLING MODE).

SEND POLLING



or



5 Enter the time at which you want the operation to take place (2 digits for the hour and 2 digits for the minute).



Example: 9:25

6 Press the * key to select A.M. or the # key to select P.M.

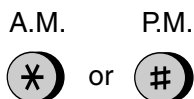

7 Enter a 1-digit number for the day of the operation (skip this step if the operation will be performed within the next 24 hours):



- 0: Sunday
- 1: Monday
- 2: Tuesday
- 3: Wednesday
- 4: Thursday
- 5: Friday
- 6: Saturday

Example:
Sunday

8 Press the **START** key.



9 Press a Rapid Key or enter a Speed Dial number for the receiving fax machine.



- If this is a polling operation, go to Step 12.

Example:
Speed Dial #01

10 Press the **START** key.



- 11** Adjust the resolution and/or contrast if desired (skip to the next step if you don't want to change settings).



- 12** Press the **START** key.

- If this is a transmission, the document is scanned into memory.



To cancel a timer operation

If you need to cancel a timer operation after it has been set, follow the steps below.

- 1** Press these keys:



The display will show:

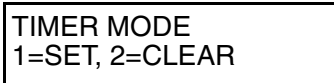

- 2** Press **2** to select CLEAR.



- 3** Enter the 1-digit number assigned to the timer job you want to cancel.

- If you don't remember the number, print out the Timer List as explained in Chapter 8.



(Example)

- 4** Press the **START** key and then the **STOP** key.

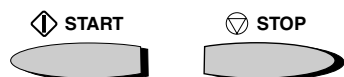

8. Printing Lists

You can print lists showing settings and information entered in the fax machine. You can also print out reports on recent activity and individual operations after they are completed. The lists and reports are described on the following pages.

To print a list, follow the steps below.

-
- 1** Press the **FUNCTION** key and **2**.



The display will show:

LISTING MODE
PRESS * OR #

-
- 2** Press the ***** key or the **#** key until the desired list appears in the display.

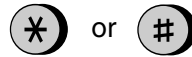

-
- 3** Press the **START** key to print the list.



Activity Report

This report shows information on your most recently performed send and receive operations (a combined maximum of 30 operations can appear). The report is divided into two parts: the TRANSMISSIONS ACTIVITY REPORT, which shows information on transmissions, and the RECEPTIONS ACTIVITY REPORT, which shows information on receptions.

- ◆ All information is erased after a report is printed out. If automatic print-out is turned off and the report is not printed manually for 30 operations, the information on the oldest operation will be overwritten each time a new operation is performed.

CANCEL - The transaction was cancelled because the **STOP** key was pressed, no document was in the feeder, or the other machine requested transmission using a function which your fax machine does not have. If you were attempting to fax, make sure a document is in the feeder. If you were receiving, contact the faxing party to see how they are trying to send to you.

If desired, you can set the Activity Report to automatically print out whenever information on 30 operations has accumulated. (A report can still be printed on demand at any time.) Follow the steps below:

-
- 1** Press these keys:

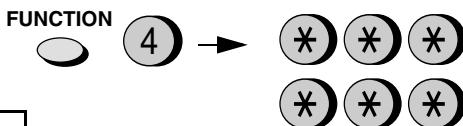

The display will show:

AUTO PRINT OUT
1=YES, 2=NO

-
- 2** Press **1** to turn on automatic print-out, or **2** to turn it off.

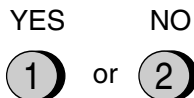

-
- 3** Press the **STOP** key to return to the date and time display.



Timer List

This list shows the timer operations that are currently set, and whether the Memory Polling function is turned on.

TIMER LIST						APR-01-2000 SAT 04:21 PM
NO.		START	TYPE	RESOLUTION	REMOTE STATION ID #	
FOR: ABC CORP.			529658742			
1	10:30 AM	SUN	SEND	STANDARD :AUTO	KENT CORP.	
2	01:15 PM	WED	POLLING		JACK SMITH	
3	05:51 PM	SAT	SEND	SUPER FINE:AUTO	ADRIAN SMITH	

Telephone Number List

This list shows the fax numbers that have been programmed for automatic dialing.

TELEPHONE NUMBER LIST				APR-01-2000 SAT 01:27 PM	
RAPID #		NAME		TELEPHONE #	CHAIN DIAL
FOR: ABC CORP.		529658742			
SPEED #					
R01	KENT CORP.	123-456-7890			
R02	JACK SMITH	333-655-7777			
R03	ADRIAN SMITH	230-347-6305			SET
S00	AL	E-MAIL STORED			
S01	ABC SOFT	666-999-0000			

Passcode List

This list shows settings made for polling security, your name and fax/telephone number as entered in the machine, and a sample of the header printed at the top of every page you transmit (**HEADER PRINT**).

PASSCODE LIST		APR-01-2000 SAT 03:56 PM
FOR: ABC CORP.		529658742
POLLING NODE	SECURITY OFF	
PASSCODE #	01	
	02	
	03	
	04	
	05	
	06	
	07	
	08	
	09	
	10	
DAY LIGHT SAVING TIME	NO	
SENDER'S NAME	ABC CORP.	
SENDER'S TELEPHONE NUMBER	529658742	
HEADER PRINT	ABC CORP.	529658742
APR-01-2000 SAT 03:56 PM		P. 01

Option Setting List

This list shows the current status of the option settings.

OPTIONAL SETTING LIST		
FOR: ABC CORP.		529658742
APR-01-2000 SAT 03:53 PM		
NO.	ITEM	SETTING
01	PAPER SIZE	LETTER
02	FINE PRIORITY	NO
03	NUMBER OF RINGS	4 RINGS
04	RECALL INTERVAL	05 MINUTES
05	RECALL TIMES	02 TIMES
06	TEL/FAX REMOTE #	(5) **
07	REMOTE RECEPTION	YES
08	TRANSACTION PRINT SELECT	ERROR ONLY
09	DIAL MODE	TO NE
10	QUIET DETECT TIME	04 SEC.
11	FAX ANSWER WHEN TAD FAILS	NO
12	DISTINCTIVE RINGING	OFF SETTING
13	FAX SIGNAL RECEIVE	YES
14	JUNK # CHECK	NO
15	POLLING	NO
16	COVER SHEET	NO
17	AUTO PRINT OUT	NO
18	ECH MODE	YES
19	BEEP LENGTH	3 SECONDS
20	QUICK ON-LINE	YES
21	RECEPTION RATIO	AUTO
22	COPY CUT OFF	YES

Junk Fax Number List

This list shows the numbers that are blocked by the Anti Junk function.

ANTI JUNK NUMBER LIST		
FOR: ABC CORP.		59658742
APR-01-2000 SAT 01:21 PM		
ANTI JUNK # CHECK: NO		
STORED	LOCATION	JUNK FAX #
1		8754215632
2		8646324456
3		8965542123

Group List

This list shows the fax numbers that have been programmed into each Group Key.

GROUP LIST		APR-01-2000 SAT 04:03 PM
FOR: ABC CORP.	529658742	
GROUP 4	REMOTE STATION ID	R01, R02, R03, R04

Transaction Report

This report is printed out automatically after an operation is completed to allow you to check the result. Your fax machine is set at the factory to print out the report only when an error occurs.

- ◆ The same headings appear in the Transaction Report as in the Activity Report. See *Activity Report* in this chapter for an explanation of the headings.
- ◆ The Transaction report cannot be printed on demand.

If desired, you can change the condition under which a report is printed out. Follow the steps below.

1 Press these keys:

FUNCTION

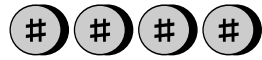

The display will show:

TRANSACTION LIST
1:ALWAYS PRINT

The selections alternately appear here.

2 Press a number from **1** to **5** to select the condition for printing.

- | | | |
|----------|---------------|---|
| 1 | ALWAYS PRINT | A report will be printed after each transmission, reception, or error. |
| 2 | ERR/TIMER/MEM | A report will be printed after an error, timer operation, or memory transmission. |
| 3 | SEND ONLY | A report will be printed after each transmission. |
| 4 | NEVER PRINT | A report will never be printed. |
| 5 | ERROR ONLY | A report will be printed only when an error occurs. |

3 Press the **STOP** key to return to the date and time display.



9. Maintenance

Scanning glass and rollers

Clean the scanning glass and rollers frequently to ensure that your transmitted images and copies are of the highest quality.

Open the operation panel (grasp the panel release and pull up), and wipe the scanning glass, rollers and white backplate with a soft cloth.

- ◆ Make sure that all dirt and stains (such as correcting fluid) are removed, as dirt and stains will cause vertical lines on transmitted images and copies.

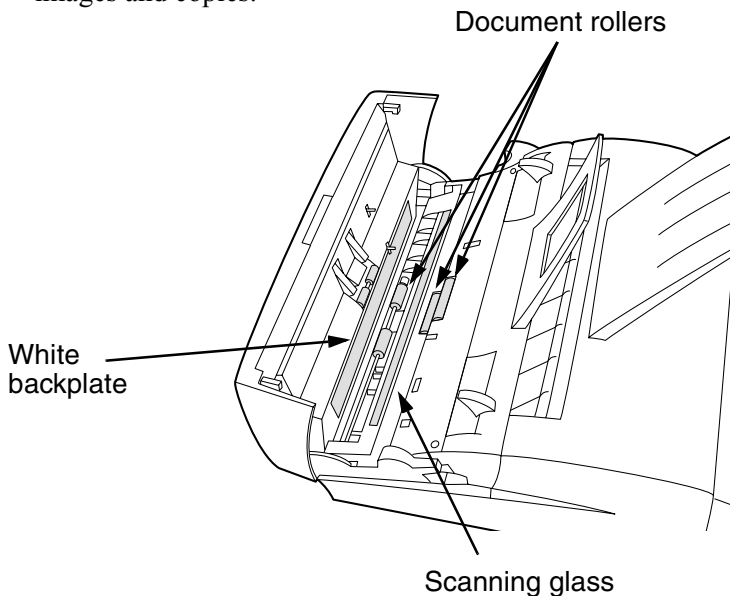

The housing

Wipe the external parts and surface of the machine with a dry cloth.

Caution!

- ◆ Do not use benzene or thinner. These solvents may damage or discolor the machine.

Replacing the toner cartridge

When the toner cartridge nears empty (about 100 pages can still be printed), the TONER EMPTY indicator on the operation panel will blink. When the toner cartridge is empty, the toner cartridge indicator will light steadily and REPLACE TONER will appear in the display. Printing will no longer be possible.

Replace the toner cartridge with the following cartridge:

Sharp FO-29ND toner cartridge

- 1 Grasp the print compartment cover at both sides as shown, and pull up to open the cover.

- **Caution!**

The fusing unit inside the print compartment becomes very hot during operation. Do not touch the inside of the compartment or the paper guide on the underside of the print compartment cover.

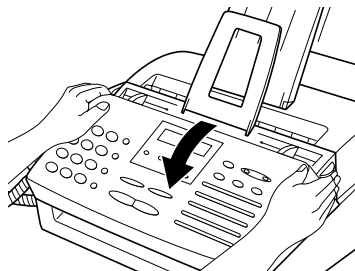

- 2 Grasp the finger hold on the toner cartridge handle where it is marked **PUSH**, and pull the handle out. Rehold the handle and pull the toner cartridge out of the compartment.

- Dispose of the old toner cartridge according to local regulations. If in doubt, contact your local waste disposal agency.

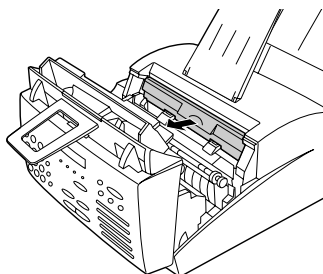

- 3 Install the new toner cartridge and reset the toner counter. (Refer to *Installing the Toner Cartridge* in Chapter 1.)

Replacing the drum cartridge

To maintain excellent printing quality, we recommend that you replace the drum cartridge about 20,000 pages have been printed. You can view the number of pages printed in the display by pressing the following sequence of keys:



When finished, press the **STOP** key to return to the date and time display.

Replace the drum cartridge with the following cartridge:

Sharp FO-29DR drum cartridge

- 1 Grasp the print compartment cover at both sides as shown, and pull up to open the cover.

- **Caution!**

The fusing unit inside the print compartment becomes very hot during operation. Do not touch the inside of the compartment or the paper guide on the underside of the print compartment cover.

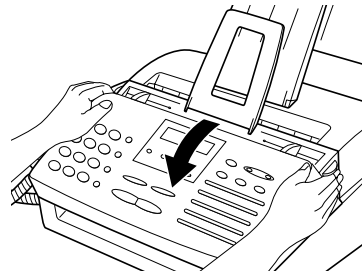

-
- 2** Grasp the finger hold on the toner cartridge handle where it is marked **PUSH**, and pull the handle out. Rehold the handle and pull the toner cartridge out of the compartment.

- Place the toner cartridge on a sheet of paper on a level surface.

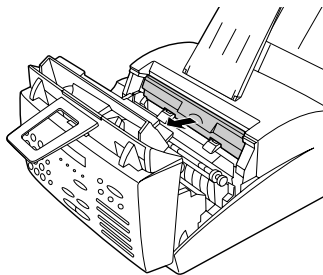

-
- 3** Grasp the tabs on the drum cartridge handle and gently pull the cartridge out of the machine.

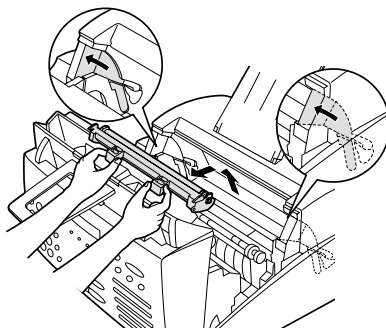

-
- 4** Remove the new drum cartridge from its packaging.

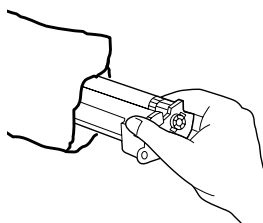

-
- 5** Insert the drum cartridge into the print compartment, aligning the guides on the cartridge with the runners on the sides of the compartment.

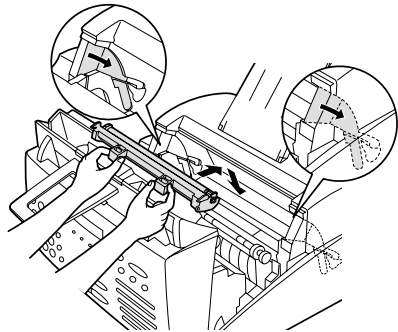

-
- 6** Gently pull the paper tab to remove the black sheet of protective paper from the drum cartridge.
- Be careful not to tear the paper or leave any pieces of paper in the machine.

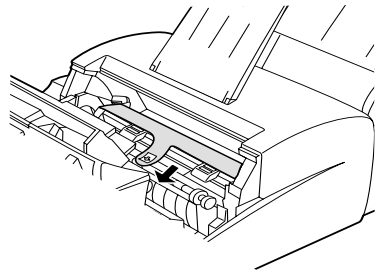

-
- 7** Replace the toner cartridge and reset the drum counter. (Refer to *Installing the Toner Cartridge* in Chapter 1.)

Cleaning the drum cartridge

If you find that characters or parts of an image are missing from your printed pages, the drum in the drum cartridge may need cleaning. Follow the steps below to clean the drum.

- 1** Grasp the print compartment cover at both sides as shown, and pull up to open the cover.

- **Caution!**

The fusing unit inside the print compartment becomes very hot during operation. Do not touch the inside of the compartment or the paper guide on the underside of the print compartment cover.

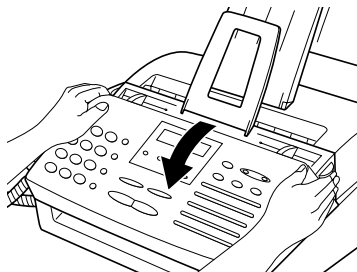

- 2** Grasp the finger hold on the toner cartridge handle where it is marked **PUSH**, and pull the handle out. Rehold the handle and pull the toner cartridge out of the compartment.

- Place the toner cartridge on a sheet of paper on a level surface.

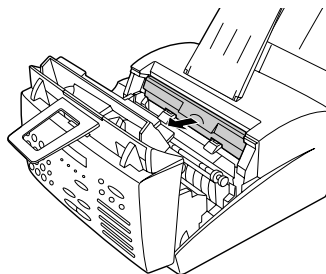

- 3** Grasp the tabs on the drum cartridge handle and gently pull the cartridge out of the machine.

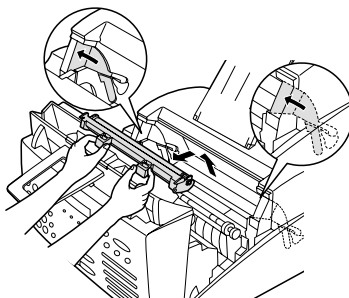

-
- 4** Take a sheet of clean paper and roll it into a tube. Roll it tightly so that the diameter of the holes at each end is less than the thickness of your little finger.

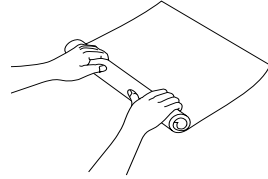

-
- 5** Gently wipe the surface of the drum with the rolled-up paper to remove any particles of toner caked on the drum.

- Do not let the drum surface come into contact with anything other than the rolled-up paper. Fingerprints, water, alcohol, and other solvents will damage the drum surface.
- Do not touch the drum surface with the edges of the rolled-up paper.

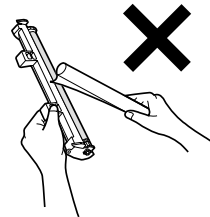
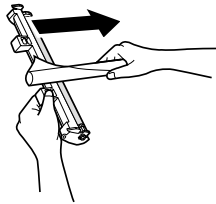

-
- 6** Replace the drum cartridge.

- To insert the cartridge, align the guides on the cartridge with the runners on the sides of the compartment.

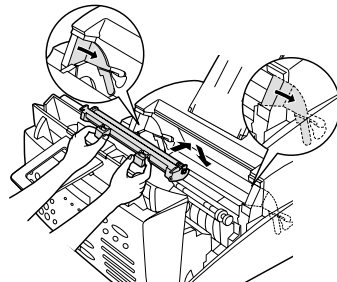

-
- 7** Replace the toner cartridge and close the print compartment cover. (Refer to *Installing the Toner Cartridge* in Chapter 1.)

10. Troubleshooting

Problems and Solutions

Line error

Problem	Solution
LINE ERROR appears in the display.	<p>Try the transaction again. If the error persists, check the following:</p> <ul style="list-style-type: none">• Check the connection. The cord from the TEL. LINE jack to the wall jack should be no longer than six feet.• Make sure there are no modem devices sharing the same telephone line.• Check with the other party to make sure their fax machine is functioning properly.• Have your telephone line checked for line noise.• Try connecting the fax machine to a different telephone line.• If the problem still occurs, your fax machine may need service.

Dialing and transmission problems

Problem	Solution
No dial tone when you pick up the handset or press the SPEAKER key.	<ul style="list-style-type: none"> • Make sure the handset cord is connected to the correct jack. See <i>Connecting the handset</i> in <i>Connections</i> in Chapter 1.
Dialing is not possible.	<ul style="list-style-type: none"> • Make sure the power cord is properly plugged into a power outlet. • Make sure that the telephone line is properly connected to both the TEL. LINE jack and the wall jack. • Make sure that the fax machine is set to the correct dialing mode for your telephone line. See <i>Connecting the telephone line cord</i> in <i>Connections</i> in Chapter 1.
The power is on, but no transmission takes place.	<ul style="list-style-type: none"> • Make sure that the receiving machine has paper. • Make sure that the telephone line cord is plugged into the TEL. LINE jack, and not the TEL. SET jack. • If the receiving machine is in manual mode with no attendant, reception will not be possible. • Check the display for error messages. • Pick up the handset and check for a dial tone.
Nothing is printed at the receiving end.	<ul style="list-style-type: none"> • Make sure that the document for transmission is placed face down in the feeder.
A distorted image is received at the other end.	<ul style="list-style-type: none"> • If Error Correction Mode is turned off (see <i>Error Correction Mode</i> in Chapter 2), noise on the telephone line may cause distortion. Try sending the document again. • Make a copy of the document on your fax machine. If the copy is also distorted, your fax machine may need service.

Reception and copying problems

Problem	Solution
<p>The fax machine doesn't receive documents automatically.</p>	<ul style="list-style-type: none"> • Make sure that the reception mode is set to FAX. If you subscribe to a distinctive ring service, make sure that the Distinctive Ring function is set to the correct ring pattern. If you do not subscribe to a distinctive ring service, make sure that Distinctive Ring is set to OFF SETTING. (See <i>Distinctive Ring</i> in Chapter 7.)
<p>The power is on, but no reception takes place.</p>	<ul style="list-style-type: none"> • Make sure that the telephone line cord is plugged into the TEL. LINE jack, and not the TEL. SET jack.
<p>The printing paper comes out blank when you try to receive a document.</p>	<ul style="list-style-type: none"> • Make sure that the document is loaded properly in the feeder of the transmitting machine. Make a copy or print a report to confirm the printing ability of your machine.
<p>The received document is faint.</p>	<ul style="list-style-type: none"> • Ask the other party to send higher contrast documents. If the contrast is still too low, your fax machine may need service. Make a copy or print a report to check your machine's printing ability. • The toner cartridge may need replacement.
<p>Received images are distorted.</p>	<ul style="list-style-type: none"> • If the sending machine has Error Correction Mode, make sure this feature is turned on in both fax machines (see <i>Error Correction Mode</i> in Chapter 2). • If Error Correction Mode is turned off, noise on the telephone line may cause distortion. Have the other party try sending the document again. • The drum cartridge may be damaged. Try a new drum cartridge. • Make a copy or print a report on your fax machine. If the copy or report is also distorted, your fax machine may need service.

The quality of copies is poor and/or black spots appear.	<ul style="list-style-type: none"> Any dirt or material on the scanning glass will cause spots to appear on copies and transmitted faxes. Clean the scanning glass as explained in Chapter 9.
Dots appear at regular intervals on received documents and copies.	<ul style="list-style-type: none"> The drum cartridge may be damaged. Replace the drum cartridge.

Answering machine connection

Problem	Solution
The answering machine connection does not operate properly.	<ul style="list-style-type: none"> Make sure your fax machine's reception mode is set to A.M. Make sure your fax machine's TEL. LINE jack is connected to the wall jack. Make sure your fax machine's TEL. SET jack is connected to your answering machine's telephone line jack (not the answering machine's extension phone jack). Make sure your answering machine's outgoing message is under 10 seconds. Make sure that the Quiet Detect Time setting is set to three or four seconds (see Chapter 6). Make sure that the Distinctive Ring function is set to OFF SETTING (see <i>Distinctive Ring</i> in Chapter 7). If you have checked all of the above and the hookup still doesn't operate properly, call the Customer Assistance Center.

General problems

Problem	Solution
Nothing appears in the display.	<ul style="list-style-type: none">• Make sure the power cord is properly plugged into a power outlet.• Connect another electrical appliance to the outlet to see if it has power.
The machine does not respond when you press any of its keys.	<ul style="list-style-type: none">• If a beep sound is not made when you press the keys, open the printer compartment cover and use pencil or pen to press the RESET button. (See the following page.)
Automatic document feeding does not work for transmission or copying.	<ul style="list-style-type: none">• Check the size and weight of the document (see <i>Transmittable Documents</i> in Chapter 2.
Voice calls taken on an extension phone are interrupted by the fax.	<ul style="list-style-type: none">• The fax may interrupt during a voice call if the reception mode is set to A.M. To prevent interruption on a tone dial extension phone, press any three keys on the extension phone after answering. (Note: Do not enter the code to activate fax reception.)
No reception occurs when polling is attempted.	<ul style="list-style-type: none">• Make sure you have not run out of paper.• Make sure the transmitting machine is in automatic reception mode.• If the transmitting machine has polling security, make sure that your fax number has been entered both in your machine and in the transmitting machine.

Using the **RESET** key

If the fax machine stops responding when you press any of the operation panel keys, you must reset it. This can be done as follows:

- 1 Grasp the print compartment cover at both sides as shown, and pull up to open the cover.

- **Caution!**

The fusing unit inside the print compartment becomes very hot during operation. Do not touch the inside of the compartment or the paper guide on the underside of the print compartment cover.

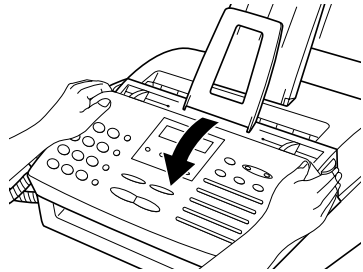

- 2 Use a ballpoint pen to press the **RESET** button.

- **Note:** Pressing the **RESET** button clears any documents that are stored in memory.

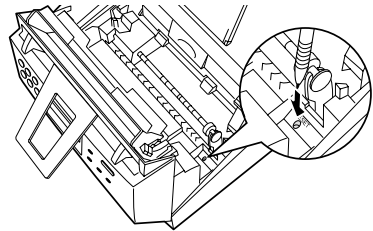

- 3 Close the print compartment cover, pressing down firmly on each side to make sure it is completely closed.

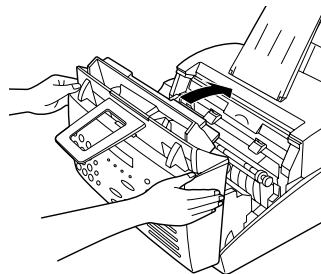

Messages and Signals

Display messages

CAN'T PRINT DATA	A fax has been received to memory because printing is not possible. This message will alternate with a message that indicates the problem. The fax will print out automatically when the problem is resolved.
CHECK PAPER SIZE	The paper size setting is incorrect. Change the paper size setting as described in <i>Loading Printing Paper</i> in Chapter 1.
CHECK PC	This appears if you press the E-MAIL key and your computer is not turned on or is not correctly connected to the fax machine.
COVER OPEN	The print compartment cover is open. Press down firmly on both sides of the print compartment cover to close it.
DOCUMENT JAMMED	The original document is jammed. See the following section, <i>Clearing Paper Jams</i> .
FUNCTION MODE	The FUNCTION key has been pressed.
GRP. SPACE FULL	This appears if you attempt to program a Group Key when all Group Keys have already been programmed.
HOLD	The HOLD/SEARCH key has been pressed to put the other party on hold during a phone conversation. Press the HOLD/SEARCH again to take the other party off hold.
LINE ERROR	Transmission or reception was not successful. Press the STOP key to clear the message and then try again. If the error persists, see <i>Line Error in Problems and Solutions</i> in this chapter.
LINE IS IN USE	An extension phone connected to the fax is being used. Do not lift the fax's handset or attempt transmission at this time, as this will interrupt the conversation on the extension phone.

MEMORY IS FULL	The memory is full. This may occur during fax reception if too much data is received before the pages can be printed out. If faxes have been received to memory because printing is not possible (an additional message will indicate the problem), resolve the problem so that printing can continue (see <i>Substitutue Reception to Memory</i> in Chapter 3). If you are attempting to transmit by automatic dialing, see <i>If the memory becomes full</i> in Chapter 2.
MEMORY PRINTING	The fax is preparing to or printing out a document from memory.
NO DATA	This appears if you attempt to search for an automatic dialing number when none have been stored.
NO # STORED	You have tried to dial or clear a Rapid Key or Speed Dial number that hasn't been programmed (a full number hasn't been assigned to it).
OFF HOOK	This appears if you forgot to replace the handset after using it to dial and send a fax. Replace the handset or press the STOP key to clear the message.
ON HOOK DIAL	The SPEAKER key has been pressed and the fax machine is waiting for you to dial.
OUT OF PAPER	You are out of printing paper (or the paper release lever is open). Load paper as explained in <i>Loading Printing Paper</i> in Chapter 1.
PAPER JAMMED	The printing paper is jammed. See the following section, <i>Clearing Paper Jams</i> .
SEND READY	A document has been loaded and the fax machine is waiting for you to begin faxing or copying.
REPLACE TONER	The toner cartridge must be replaced.
SEARCH DIAL	The HOLD/SEARCH key has been pressed. Press # or * to search for an automatic dialing number, or press the STOP key to return to the date and time display. (See <i>Searching for an auto-dial number in Sending a Fax by Automatic Dialing</i> in Chapter 2.)

SIZE ERROR	The paper size setting is longer than the paper loaded in the tray. Change the paper size setting as explained in <i>Loading Printing Paper</i> in Chapter 1. This message also appears if paper smaller than letter size has been loaded. In this case, change the paper to letter, legal, or A4 size paper.
TOTAL PAGE(S) 1	Number of pages transmitted, received, or copied.
TX MEMORY FULL	This message appears if you insert a document into the document feeder when 30 transmission jobs are already waiting in memory for transmission. You can continue setting up the transmission job after the job currently being sent is completed. This message may also appear if faxes have been received to memory due to a printing problem. In this case, resolve the problem so that printing can take place and free memory.

Audible signals

Continuous tone	3 seconds	Indicates the end of transmission, reception, or copying.
Intermittent tone (3 beeps)	5 seconds (1 second on, 1 second off)	Indicates incomplete transmission, reception, or copying.
Rapid intermittent tone	Continuous (0.7 seconds on, 0.3 seconds off)	Indicates that the handset is off hook.

Clearing Paper Jams

Clearing a jammed document

If the original document doesn't feed properly during transmission or copying, or DOCUMENT JAMMED appears in the display, first try pressing the **START** key. If the document doesn't feed out, open the operation panel and remove it.

Important:

Do not try to remove a document without opening the operation panel. This may damage the feeder mechanism.

- 1** Open the operation panel by grasping the panel release and pulling up.

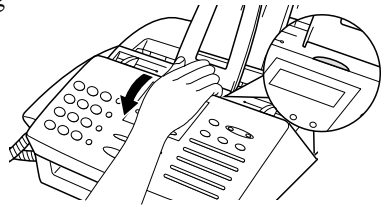

- 2** Remove the document.

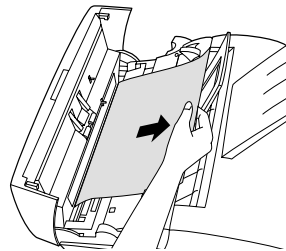

- 3** Close the operation panel, making sure it clicks into place.

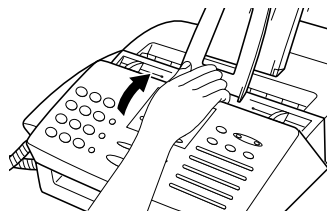

Clearing jammed printing paper

- 1** If most of the jammed page is protruding from the back of the fax, pull the paper release lever toward you and try pulling the page out.

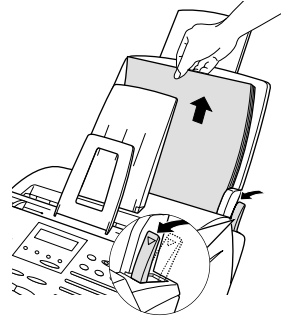

- 2** If the jammed page comes out, take out the rest of the paper in the tray, straighten the stack, put it back in the paper tray, and push down the paper release lever.

- If you are unable to clear the jam in this way, continue with the following steps.

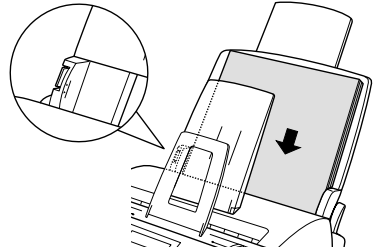

- 3** Grasp the print compartment cover at both sides as shown, and pull up to open the cover.

- **Caution!**
The fusing unit inside the print compartment becomes very hot during operation. Be careful not to touch the inside of the compartment.

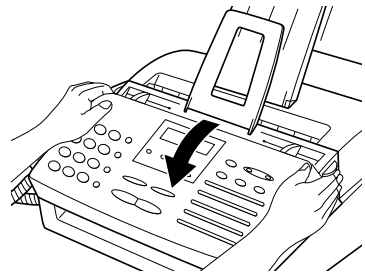

-
- 4** Grasp the finger hold on the toner cartridge handle where it is marked **PUSH**, and pull the handle out. Rehold the handle and pull the toner cartridge out of the compartment.

- Place the toner cartridge on a sheet of paper on a level surface.

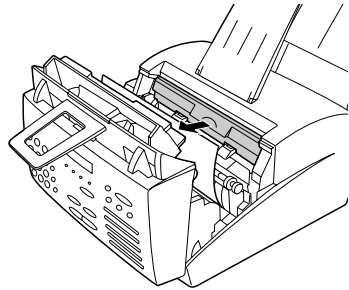

-
- 5** Grasp the tabs on the drum cartridge handle and gently pull the cartridge out of the machine.

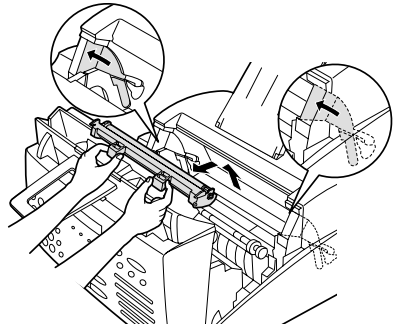

-
- 6** Wrap the drum cartridge in a large sheet of paper as shown at right so that the green drum section is shielded from light, and place it gently on a level surface.

- Do not touch the green drum in the drum cartridge. This will damage the drum surface.
- Do not expose the drum to direct light. This will damage the drum.

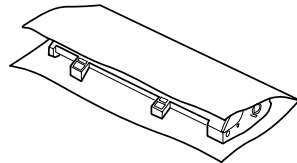

7 Gently pull the jammed paper out of the machine.

- If needed, turn the wheel on the right side of the fusing unit to eject the paper from the machine.

- **Caution!**

Do not use excessive force to pull the jammed paper out. If the paper tears and a piece remains inside the machine, a service call may be necessary to remove the remaining piece.

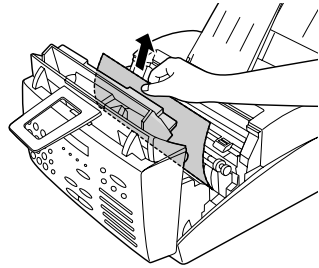

Fusing unit

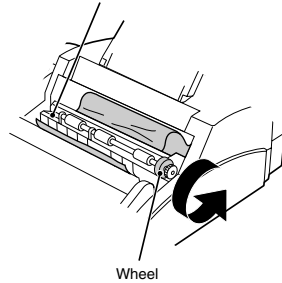

Wheel

8 Replace the drum cartridge.

- To insert the cartridge, align the guides on the cartridge with the runners on the sides of the compartment.

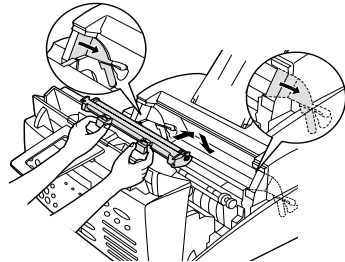

9 Replace the toner cartridge and close the print compartment cover. (Refer to *Installing the Toner Cartridge* in Chapter 1.)

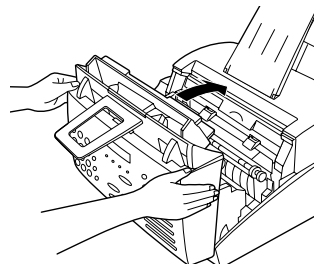
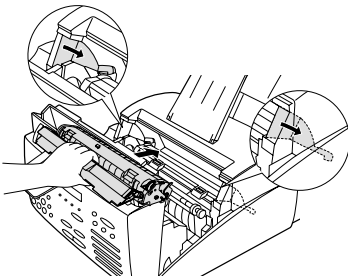

FCC Regulatory Information

This equipment complies with FCC rules, Part 68. On this equipment is a label that contains, among other information, the FCC Registration Number and Ringer Equivalence Number (REN) for this equipment. If requested, this information must be provided to your telephone company.

An FCC compliant telephone cord and modular plug is provided with this equipment. This equipment is designed to be connected to the telephone network or premises wiring using a compatible modular jack which is Part 68 compliant. This equipment connects to the telephone network through a standard USOC RJ-11C network interface jack.

The REN is used to determine the quantity of devices which may be connected to your telephone line and still have all of those devices ring when your number is called. Too many devices on one line may result in the devices not ringing in response to an incoming call. In most, but not all, areas as the sum of the RENs of all devices should not exceed five (5.0). To be certain of the number of devices that may be connected to your line, as determined by the total REN, contact your local telephone company.

If this equipment causes harm to the telephone network, your telephone company may disconnect your service temporarily. If possible, they will notify you in advance. If advance notice is not practical, you will be notified as soon as possible. You will also be advised of your right to file a complaint with the FCC.

Your telephone company may make changes in its facilities, equipment, operations, or procedures that could affect the operation of your equipment. If this happens, the telephone company will provide advance notice in order for you to make necessary modifications to maintain uninterrupted service. If the equipment is causing harm to the telephone network, your telephone company may ask you to disconnect the equipment until the problem resolved.

If you have any questions or problems which cannot be solved by reading this manual, please contact Sharp Electronics Corporation at Sharp Plaza, Mahwah, NJ 07430-2135. The customer number is 800-237-4277.

This equipment may not be used on coin service provided by the telephone company. Connection to party lines is subject to state tariffs. Contact your state's public utility commission, public service commission, or corporation commission for more information.

When programming and/or making test calls to emergency numbers:

- ◆ Remain on the line and briefly explain to the dispatcher the reason for the call.
- ◆ Perform such activities in the off-peak hours, such as early morning or late evening.

S H A R P

Date Revised : _____

Date Issued : July, 16, 1999

MATERIAL SAFETY DATA SHEET (1/2)

MSDS No. P-00102

Section 1. Product Identification

Product: FO-2950/FO29ND,FO-29DC,FO-29DCCN (Black Toner)

Section 2. Supplier's Name and Address

Sharp Corporation
22-22 Nagaike-cho, Abeno-ku, Osaka, Japan
Local suppliers are listed below. Please contact the nearest supplier for additional information.

(Country)	(Name and Telephone Number)
U.S.A	Sharp Document Network System of America Telephone number for information : 1-800-237-4277 Emergency telephone number : 1-800-255-3924
Canada	Sharp Electronics of Canada Ltd. Telephone number for information : 905-890-2100 Emergency telephone number : 1-800-255-3924
United Kingdom	Sharp Electronics (U.K.) Ltd. Telephone number for information : 01923-474013

Section 3. Ingredients

Ingredients	CAS No.	Proportion	OSHA PEL	ACGIH TLV	Other Limits
Carbon black	1333-86-4	> 5%	3.5mg/m ³	3.5mg/m ³	None
Styrene-Acrylate copolymer	25036-16-2	> 90%	Not listed	Not listed	None
Iron oxide	1317-61-9	< 2%	Not listed	Not listed	None
Silica	68909-20-6	< 2%	0.8mg/m ³	10mg/m ³	None

Section 4. Hazardous Identification (Emergency Overview)

Toner is a fine, black powder possessing no immediate hazard. There are no anticipated carcinogenic effects from exposure based on animal tests performed using toner. When used as intended according to instructions, studies do not indicate any symptoms of fibrosis will occur.

Section 5. Health Hazard Data

Route(s) of Entry	: Inhalation?	Skin?	Ingestion?
	Yes	No	Possible but very unusual.
Health Hazards	: Acute oral toxicity—LD50 of this toner is over 2,000mg/kg. Mutagenicity—The result of Ames test is negative.		
Carcinogenicity	: In 1996 the IARC reevaluated carbon black as a Group 2B carcinogen (possible human carcinogen). This classification is given to chemicals for which there is inadequate human evidence, but sufficient animal evidence on which to base an opinion of carcinogenicity. The classification is based upon the development of lung tumors in rats receiving chronic inhalation exposures to free carbon black at levels that induce particle overload of the lung. Studies performed in animal models other than rats did not show any association between carbon black and lung tumors. Moreover, a two-year cancer bioassay using a typical toner preparation containing carbon black demonstrated no association between toner exposure and tumor development in rats.		
Chronic Effect	: In a study in rats of chronic inhalation exposure to a typical toner, a mild to moderate degree of lung fibrosis was observed in 92% of the rats in the high concentration (16mg/m ³) exposure group, and a minimal to mild degree of fibrosis was noted in 22% of the animals in the middle (4mg/m ³) exposure group, but no pulmonary change was reported in the lowest (1mg/m ³) exposure group, the most relevant level to potential human exposures.		
Signs and Symptoms of Exposure	: Minimal irritation to respiratory tract may occur as with exposure to any non-toxic dust.		
Medical Conditions Generally Aggravated by Exposure	: None		

S H A R P

Date Revised :

Date Issued : July. 16. 1999

MATERIAL SAFETY DATA SHEET (2/2)

MSDS No. P-00102

Section 5. Health Hazard Data

Emergency and First Aid Procedures :

Inhalation : Remove to fresh air. If effects occur, consult medical personnel.
Eye : In case of contact, immediately flush eyes with water for 15 minutes.

Section 6. Physical Chemical Characteristics

Boiling/Melting Point	: Not applicable	Specific Gravity	: 1.1
Vapor Pressure	: Not applicable	Solubility in Water	: Negligible
Vapor Density	: Not applicable	PH	: Not applicable
Evaporation Rate	: Not applicable	Viscosity	: Not applicable
Appearance	: Fine powder	Color	: Black
Odor	: Odorless		

Section 7. Fire and Explosion Data

Flash Point (Method Used)	: Not applicable
Ignition Temperature	: No data available
Flammable Limits	: (LEL); Not applicable (UEL); Not applicable
Extinguishing Media	: CO ₂ , dry chemical, foam or water
Special Fire Fighting Procedure	: None
Unusual Fire and Explosion Hazard	: This material has no unusual fire or explosion hazards.
Sensitivity to Mechanical Impact	: None
Sensitivity to Static Charge	: None

Section 8. Reactivity Data

Stability	: Stable
Incompatibility (Material to Avoid)	: None
Hazardous Decomposition	: CO
Hazardous Polymerization	: Will not occur.

Section 9. Precautions for Safe Handling and Use

Personal Protection Information (Respiratory, Eye Protection and Protective Glove):

Use of a dust mask is recommended when handling a large quantity of toner or during long term exposure, as with any non-toxic dust.

Engineering Control/Ventilation	: Not required.
Work/Hygienic Practice	: Inhalation should be minimized as with any non-toxic dust.
Steps to be taken in case of Spill or Leak	: Sweep up or clean up with vacuum cleaner.
Waste Disposal Method	: Waste material may be dumped or incinerated under conditions which meet all federal, state and local environmental regulations.

Section 10. Regulatory Information

NFPA Rating (U.S.A)	: Health = 1 Flammability = 1 Reactivity = 0
WHMIS Legislation (Canada)	: This product is not a controlled product.
Transport Information	: This product is not a hazardous material.
UN No.	: None allocated.

Section 11. Other Information

References : IARC (1996) Monographs on the Evaluation of the Carcinogenic Risk of Chemicals to Humans, Vol. 65, Printing Process and Printing inks, Carbon Black and Some Nitro Compounds, Lyon, pp-149-261
H. Muhle, B. Bellmann, O. Creutzenberg, C. Dasenbrock, H. Ernst, R. Kilpper, J. C. Mackenzie, P. Morrow, U. Mohr, S. Takenaka, and R. Mermelstein (1991) Pulmonary Response to Toner upon Chronic Inhalation Exposure in Rats. Fundamental and Applied Toxicology 17, pp. 280-299

Quick Reference Guide

Entering Your Name and Number

1. Press: **FUNCTION** **3** **#** **#**

Display shows: OWN NUMBER SET
PRESS START KEY

2. Press:

3. Enter your fax number (max. of 20 digits) by pressing the number keys.

- To insert a space between digits, press the **#** key.
- If you make a mistake, press the **SPEED DIAL** key to backspace and clear the mistake.

4. Press:

5. Enter your name by pressing the appropriate number keys as shown below.

- To enter two letters in succession that require the same key, press the **SPEAKER** key after entering the first letter.

SPACE =	J =	T =
A =	K =	U =
B =	L =	V =
C =	M =	W =
D =	N =	X =
E =	O =	Y =
F =	P =	Z =
G =	Q =	
H =	R =	
I =	S =	

- To change case, press the **REDIAL** key. Press **#** or ***** to scroll through symbols and special characters.

6. When finished, press:

Setting the Date and Time

1. Press: **FUNCTION** **3** ***** ***** *****

Display shows: DATE & TIME SET
PRESS START KEY

2. Press:

3. Enter two digits for the month (01 to 12).

4. Enter two digits for the day (01 to 31).

5. Enter four digits for the year (Ex: 2000)

6. Enter two digits for the hour (01 to 12) and two digits for the minute (00 to 59).

7. Press ***** for A.M. or **#** for P.M.

8. When finished, press:

Storing and Clearing Auto Dial Numbers

1. Press: **FUNCTION** **3** **#**

Display shows: FAX/TEL # MODE
1=SET, 2=CLEAR

2. Press **1** to store a number or **2** to clear a number.

3. Press a Rapid Key or enter a 2-digit Speed Dial number (from **00** to **99**). (If you are clearing a number, go to Step 7.)

4. Enter the full fax/telephone number.

5. Press:

6. Enter the name of the location by pressing number keys. (Refer to the letter entry table in *Entering Your Name and Number*.)

7. Press:

Sending Faxes

Place your document (up to 20 pages) face down in the document feeder.



Normal Dialing



1. Lift the handset or press
2. Dial the fax number.
3. Wait for the reception tone (if a person answers, ask them to press their Start key).

4. Press: 

Rapid Key Dialing

Press the appropriate Rapid Key. Transmission will begin automatically.

Speed Dialing

1. Press: 
2. Enter the 2-digit Speed Dial number.
3. Press: 

Receiving Faxes

Press the **RECEPTION MODE** key until the arrow in the display points to the desired reception mode.

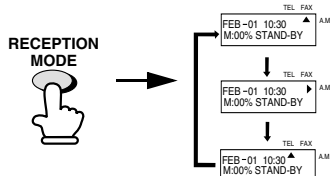

FAX mode: The fax machine automatically answers on four rings and receives the incoming document.

TEL mode:

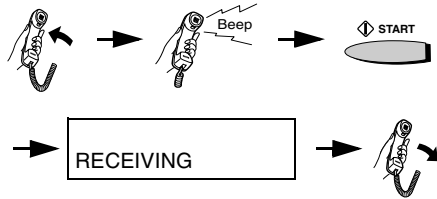

A.M. mode: Select this mode when an answering machine is connected to the fax and the answering machine is turned on.

Guía de referencia rápida

Introducción de su nombre y número

1. Pulse:
 El visor muestra:

2. Pulse:

3. Introduzca su número de telefax (20 dígitos como máx.) mediante pulsación de las teclas numéricas.

- Pulse la tecla # para introducir un espacio libre.

- Si cometiera un error, pulse la tecla **SPEED DIAL** (marcación rápida) para volver un puesto y corregirlo.

4. Pulse:

5. Introduzca su nombre mediante pulsación de las teclas numéricas adecuadas como se muestra a continuación.

- Para introducir dos letras sucesivas que requieran el mismo código, pulse la tecla **SPEAKER** (altavoz) después de introducir la primera letra.

SPACE =	J =	T =
A =	K =	U =
B =	L =	V =
C =	M =	W =
D =	N =	X =
E =	O =	Y =
F =	P =	Z =
G =	Q =	
H =	R =	
I =	S =	

- Para cambiar de mayúscula a minúscula y viceversa, pulse la tecla **REDIAL** (repetición de llamada). Pulse la tecla # o * para hojear por los símbolos y caracteres especiales.

6. Una vez finalizado pulse:

Ajuste de la fecha y hora

1. Pulse:

El visor muestra:

2. Pulse:

3. Introduzca dos dígitos para el mes (01 hasta 12).

4. Introduzca dos dígitos para el día (01 hasta 31).

5. Introduzca cuatro dígitos para el año (Ej.: 2000).

6. Introduzca dos dígitos para la hora (01 hasta 12) y dos dígitos para los minutos (00 hasta 59).

7. Pulse * para A.M. o # para P.M.

8. Una vez finalizado pulse:

Memorización y borrado de números de marcación automática

1. Pulse:

El visor muestra:

2. Pulse **1** para guardar un número o **2** para borrarlo.

3. Pulse Usted una tecla rápida o entre un número de 2 dígitos de discado rápido (entre **00** y **99**), (si Usted está borrando un número, siga con el paso 7.)

4. Introduzca el número de telefax/teléfono completo.

5. Pulse:

6. Introduzca el número del puesto mediante pulsación de las teclas numéricas. (Consulte la tabla para introducción de letras en la *Introducción de su nombre y número*).

7. Pulse:

Transmisión de mensajes telefax

Coloque el original (hasta 20 páginas) cara abajo en el alimentador de documentos.



Marcación normal



1. Levante el auricular o pulse: 
2. Marque el número de telefax.
3. Espere hasta escuchar el tono de recepción (si contestara una persona, pídale pulsar su tecla Start).

4. Pulse: 

Marcación rápida

Pulse la tecla de marcación rápida adecuada.
La transmisión se inicia automáticamente.

Marcación abreviada

1. Pulse: 
2. Introduzca el número de dos dígitos de marcación abreviada.
3. Pulse: 

Recepción de mensajes telefax

Pulse Usted la tecla **RECEPTION MODE** hasta que la flecha en el display indique el modo de recepción deseado.

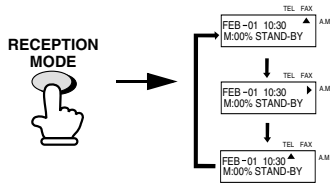

Modo FAX: El aparato telefax contesta automáticamente tras cuatro llamadas del timbre y recibe el documento entrante.

Modo TEL:

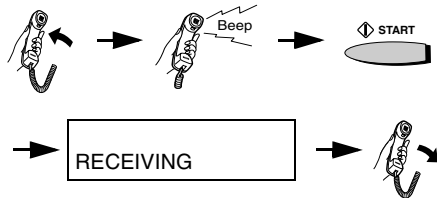

Modo A.M. Seleccione este modo si se encuentra conectado un contestador automático al aparato de fax y el contestador automático está encendido.

Index

A

A.M. reception mode, 35, 82
Activity Report, 110
 Auto print-out, 112
Answering machine hookup
 Activating, 82
 Connecting, 81
 Fax reception when TAD fails, 85
 Quiet Detect Time, 84
 Troubleshooting, 127
Anti Junk Fax, 99 - 100
Anti Junk Number List, 114
Audible signals, 132
Auto-dial numbers, storing, 53

B

Batch page numbering, 97
Beep length, 41
Broadcasting, 86 - 88

C

Chain Dialing, 55
Contrast, 47
Copies, 76 - 78
Copy cut off setting, 78
Cover sheet, 94 - 96

D

Date, setting, 32
Daylight Saving Time, 34
Dial mode, 14
Dialing
 Chain, 55
 Direct Keypad, 60
 Normal, 50, 79
 Rapid Key, 58, 79

Speed, 59, 79

Direct Keypad Dialing, 60
Display messages, 130 - 132
Distinctive ring, 91
Document feeder, 44
Document guides, 44
Document restrictions, 43
Document sizes, 42
Document, maximum scanning size, 43
Drum cartridge
 Cleaning, 122 - 123
 Preparing, 17 - 18
 Replacing, 119 - 121

E

ECM (Error Correction Mode), 65
E-MAIL, 8
Extension telephone
 Connecting, 16
 Using, 70

F

FAX reception mode, 35, 67
Fax Signal Receive, 73
Fine resolution priority, 49

G

Group Keys, 89 - 90
Group List, 115

H

Halftone setting, 47
Handset, 12
Handset receiver volume, 39
Hold, 80
Housing, cleaning, 117

J

Jams, clearing, 133 - 136

L

Letters, entering, 30

Line error, 124

LINE IN USE light, 8

Loading printing paper, 21 - 23

Loading the document, 44

M

Memory

 Checking documents in, 64

 Sending faxes from, 57

 Substitute reception to, 75

N

Normal Dialing, 50, 79

Number of rings in FAX reception mode,
68

O

Option Setting List, 114

Original document support, 15

P

Paper jams, clearing, 133 - 136

Paper size setting, 23

Paper, loading, 21 - 23

Parallel cable, connecting, 24

Passcode List, 113

Pauses in automatic dialing, 53

Polling, 101 - 106

Power cord, 13

Q

Quick Online, 66

R

Rapid Key Dialing, 58, 79

Recall interval, 62

Recall times, 63

Receive unit setting, 36

Reception mode

 A.M. mode, 35, 82

 FAX mode, 35, 67

 Setting, 35

 TEL mode, 35, 69

Reception Ratio setting, 74

Redialing, 51, 62, 80

Remote reception setting, 72

Removing original document, 45

Resolution, 47

Ringer volume, 40

S

Scanning glass, cleaning, 117

Search Dial, 61, 80

Sender's name and number, entering, 28
- 31

Sharp Laser Multifunction software, installing, 26

Speaker volume, 38

Speed Dialing, 59, 79

T

TEL reception mode, 35, 69

TEL. LINE jack, 14

TEL. SET jack, 16, 81

Tel/Fax Remote Number, 71, 72

Telephone line cord, 14

Telephone Number List, 113

Time, setting, 32

Timer List, 113

Timer operations, 107 - 109

Toner cartridge

 Installing, 17 - 20

 Replacing, 118

Index

Transaction Report, 115

Setting print-out condition, 115

Index

NOTICE

BE SURE TO ASK YOUR AUTHORIZED SHARP DEALER ABOUT THE WARRANTY THAT YOUR SELLING DEALER EXTENDS TO YOU. In order to assure you, the end-user, of warranty protection, Sharp extends a limited warranty to each of its authorized dealers and, in turn, requires each of its authorized dealers to extend its own warranty to you on terms that are no less favorable than those given to the dealer by Sharp. You should be aware, however, that Sharp does not itself extend any warranties, either express or implied, directly to you, the end-user, and no one is authorized to make any representations or warranties on behalf of Sharp. Specifically, SHARP DOES NOT EXTEND TO YOU, THE END-USER, ANY EXPRESS WARRANTY OR ANY IMPLIED WARRANTY OF MERCHANTABILITY, FITNESS FOR USE OR FITNESS FOR ANY PARTICULAR PURPOSE IN CONNECTION WITH THE HARDWARE, SOFTWARE OR FIRMWARE EMBODIED IN, OR USED IN CONJUNCTION WITH THIS PRODUCT. Sharp is not responsible for any damages or loss, either direct, incidental or consequential, which you, the end-user, may experience as a result of your purchase or use of the hardware, software or firmware embodied in or used in conjunction with this Product. Your sole remedy, in the event that you encounter any difficulties with the Product, is against the authorized dealer from which you purchased the Product. In the event that this authorized dealer does not honor its warranty commitments, please contact the Vice President, Sharp Document Network System of America, Business Product Group, Sharp Plaza, Mahwah, NJ 07430-2135, so that Sharp can try to help assure complete satisfaction of all the warranty rights to which you are entitled from the authorized dealer.

SHARP®

SHARP DOCUMENT NETWORK SYSTEM OF AMERICA

Sharp Plaza, Mahwah, New Jersey 07430-2135

SHARP CORPORATION

FOR YOUR RECORDS

Please record the model number and serial number below, for easy reference, in case of loss or theft. These numbers are located on the rear side of the unit. Space is also provided for other relevant information.

Model Number _____

Serial Number _____

Date of Purchase _____

Place of Purchase _____

PRINTED IN CHINA

(TINSE4094SCZA)

Free Manuals Download Website

<http://myh66.com>

<http://usermanuals.us>

<http://www.somanuals.com>

<http://www.4manuals.cc>

<http://www.manual-lib.com>

<http://www.404manual.com>

<http://www.luxmanual.com>

<http://aubethermostatmanual.com>

Golf course search by state

<http://golfingnear.com>

Email search by domain

<http://emailbydomain.com>

Auto manuals search

<http://auto.somanuals.com>

TV manuals search

<http://tv.somanuals.com>