

DIGITAL MULTIFUNCTIONAL SYSTEM

# Quick Start Guide



## Before using the machine

Functions of the machine and procedures for placing originals and loading paper.

## Copying

Using the copy function.

## Printing

Using the printer function.

## Faxing

Using the fax function.

## Scanning

Using the scan function.

## Document filing

Storing jobs as files on the hard drive.

## System settings

Configuring settings to make the machine easier to use.

## Troubleshooting

Frequently asked questions and how to clear paper misfeeds.

Keep this manual close at hand for reference whenever needed.

# OPERATION MANUALS AND HOW TO USE THEM

Three printed manuals and a manual in PDF format are provided with the machine.

## Printed manuals



To learn the parts of the machine and how to use them  
To load paper  
**Before using the machine (page 9)**



To make a copy  
**Copying (page 29)**



To print a file  
**Printing (page 57)**



To send a fax  
**Faxing (page 71)**



To send a scanned image  
To use Internet fax  
**Scanning (page 95)**



What is document filing?  
What is it used for?  
**Document filing (page 117)**



What are the system settings?  
**System settings (page 127)**



Frequently asked questions and how to  
clear paper misfeeds  
**Troubleshooting (page 131)**

## Quick Start Guide

(this manual)

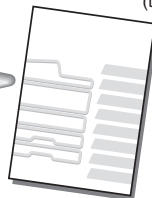

This manual provides easy-to-understand explanations of the functions of the machine in a single manual.

The explanations in this manual focus on frequently used functions. For special functions, troubleshooting, and detailed procedures for using the machine, see the manual in PDF format.



Please read before  
using the machine.

## Maintenance & Safety Guide

Contains important cautionary information, procedures for cleaning the machine and replacing supplies, and machine specifications.



## Software Setup Guide

Explains the procedures for installing the printer driver and scanner driver.

# Manuals in PDF format

Detailed explanations of the functions that can be used on the machine are provided in the Operation Guide in PDF format. The Operation Guide can be downloaded from the Web pages in the machine.



## Operation Guide

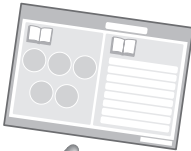

Download the Operation Guide from the Web pages in the machine.

Name	Desc
<input checked="" type="radio"/> Operation Guide	Opera

Download(O)



For the downloading procedure, see "Downloading the Operation Guide" (page 4).

### Convenient methods for using the Operation Guide

The first page contains a regular table of contents as well as an "I want to..." table of contents.

"I want to..." lets you jump to an explanation based on what you want to do. For example, "I use the copier function often, so I'd like to save paper".

Use either table of contents as appropriate based on what you want to know.

The contents of the Operation Guide are as follows:

- BEFORE USING THE MACHINE
- COPIER
- PRINTER
- FACSIMILE
- SCANNER / INTERNET FAX
- DOCUMENT FILING
- SYSTEM SETTINGS
- TROUBLESHOOTING

\* To view the Operation Guide in PDF format, Adobe® Reader® or Acrobat® Reader® of Adobe Systems Incorporated is required.

Adobe® Reader® can be downloaded from the following URL:

<http://www.adobe.com/>

# CHECKING THE IP ADDRESS

To check the IP address of the machine, print out the all custom setting list in the system settings.

SYSTEM  
SETTINGS



**1 Press the [SYSTEM SETTINGS] key.**

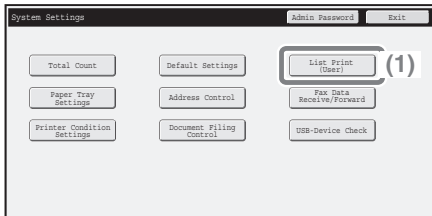

**2 Select the all custom setting list in the touch panel.**

**(1) Touch the [List Print (User)] key.**

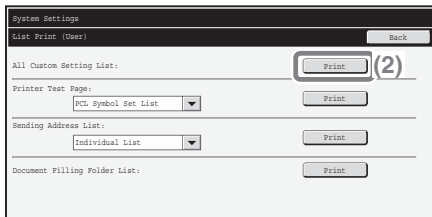

**(2) Touch the [Print] key to the right of "All Custom Setting List".**

The IP address is shown in the list that is printed.

# ACCESSING THE WEB SERVER IN THE MACHINE

When the machine is connected to a network, the machine's built-in Web server can be accessed from a Web browser on your computer.

## Opening the Web pages

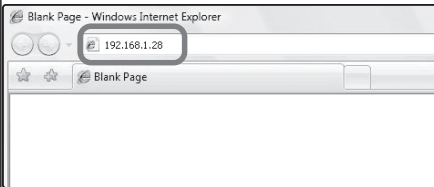

**Access the Web server in the machine to open the Web pages.**

**Start a Web browser on a computer that is connected to the same network as the machine and enter the IP address of the machine.**

Recommended Web browsers

- Internet Explorer: 6.0 or higher (Windows®)
- Netscape Navigator: 9 (Windows®)
- Firefox: 2.0 or higher (Windows®)
- Safari: 1.5 or higher (Macintosh)

The Web page will appear.

The machine settings may require that user authentication be performed in order to open the Web page. Please ask the administrator of the machine for the password that is required for user authentication.

# Downloading the Operation Guide

The Operation Guide, which is a more detailed manual, can be downloaded from the machine's Web pages.

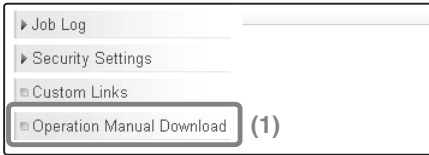

## Downloading the Operation Guide.

(1) Click [Operation Manual Download] in the menu of the Web page.

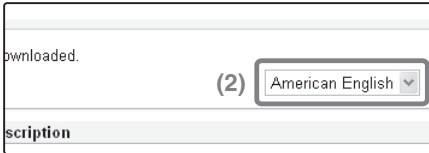

(2) Select the desired language.

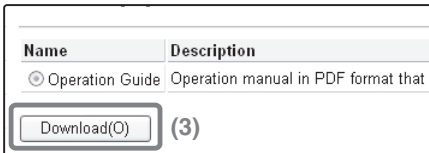

(3) Click the [Download] button.

The Operation Guide is downloaded.

# TABLE OF CONTENTS

CHECKING THE IP ADDRESS . . . . .	2
ACCESSING THE WEB SERVER IN THE MACHINE . . . . .	3

## Before using the machine

PART NAMES AND FUNCTIONS . . . . .	10
SUPPLIES . . . . .	11
OPERATION PANEL . . . . .	12
USING THE TOUCH PANEL . . . . .	14
USER AUTHENTICATION . . . . .	17
HOME SCREEN . . . . .	19
IMAGE CHECK FUNCTION (PREVIEW) . . . . .	20
PLACING ORIGINALS . . . . .	22
CHANGING PAPER IN A TRAY . . . . .	24

## Copying

BASE SCREEN OF COPY MODE . . . . .	30
MAKING COPIES . . . . .	32
2-SIDED COPYING (Automatic Document Feeder) . . . . .	34
COPYING ON SPECIAL PAPER (Bypass Copy) . . . . .	36
SELECTING THE EXPOSURE AND IMAGE TYPE . . . . .	39
FITTING THE COPY IMAGE TO THE PAPER (Automatic Ratio Selection) . . . . .	41
ENLARGEMENT/REDUCTION (Preset Ratios / Zoom) . . . . .	43
INTERRUPTING A COPY RUN (Interrupt Copy) . . . . .	45
STORING COPY OPERATIONS (Job Programs) . . . . .	46
SPECIAL MODES . . . . .	49
SELECTING A SPECIAL MODE . . . . .	50
CONVENIENT COPY FUNCTIONS . . . . .	52

## Printing

PRINTING .....	58
CANCELING PRINTING (AT THE MACHINE) .....	64
SELECTING PRINT SETTINGS .....	65
CONVENIENT PRINTER FUNCTIONS.....	67

## Faxing

BASE SCREEN OF FAX MODE .....	72
SENDING A FAX.....	74
CHANGING THE SIZE OF A FAX.....	75
CHANGING THE EXPOSURE .....	77
CHANGING THE RESOLUTION.....	78
STORING A FAX NUMBER .....	79
FORWARDING RECEIVED FAXES (Fax Data Forward) .....	81
CONVENIENT DIALING METHODS.....	83
SENDING THE SAME FAX TO MULTIPLE DESTINATIONS (Broadcast Transmission).....	87
SPECIAL FAX MODES.....	89
SELECTING A SPECIAL MODE.....	90
CONVENIENT FAX FUNCTIONS .....	92



## Scanning

NETWORK SCANNER FUNCTION .....	96
BASE SCREEN OF SCAN MODE .....	97
SCANNING AN ORIGINAL .....	98
CHANGING THE EXPOSURE AND ORIGINAL IMAGE TYPE .....	100
CHANGING THE RESOLUTION .....	102
CHANGING THE FILE FORMAT .....	103
STORING A DESTINATION .....	105
CONVENIENT TRANSMISSION METHODS .....	107
SENDING THE SAME IMAGE TO MULTIPLE DESTINATIONS (Broadcast Transmission) .....	110
SPECIAL SCAN MODES .....	112
SELECTING A SPECIAL MODE .....	113
CONVENIENT SCANNER FUNCTIONS .....	115

## Document filing

DOCUMENT FILING .....	118
QUICKLY SAVING A JOB (Quick File) .....	120
APPENDING INFORMATION WHEN STORING A FILE (File) .....	121
SAVING A DOCUMENT ONLY (Scan to HDD) .....	124
PRINTING A SAVED FILE .....	126

## System settings

SYSTEM SETTINGS .....	128
-----------------------	-----

## Troubleshooting

FREQUENTLY ASKED QUESTIONS .....	132
REMOVING MISFEEDS .....	138



# Before using the machine

This section provides general information about the machine, including the names and functions of the parts of the machine and its peripheral devices, and the procedures for placing originals and loading paper.

▶ <b>PART NAMES AND FUNCTIONS</b> .....	<b>10</b>
▶ <b>SUPPLIES</b> .....	<b>11</b>
▶ <b>OPERATION PANEL</b> .....	<b>12</b>
▶ <b>USING THE TOUCH PANEL</b> .....	<b>14</b>
▶ <b>USER AUTHENTICATION</b> .....	<b>17</b>
▶ <b>HOME SCREEN</b> .....	<b>19</b>
▶ <b>IMAGE CHECK FUNCTION (PREVIEW)</b> .....	<b>20</b>
▶ <b>PLACING ORIGINALS</b> .....	<b>22</b>
▶ <b>CHANGING PAPER IN A TRAY</b> .....	<b>24</b>

# PART NAMES AND FUNCTIONS

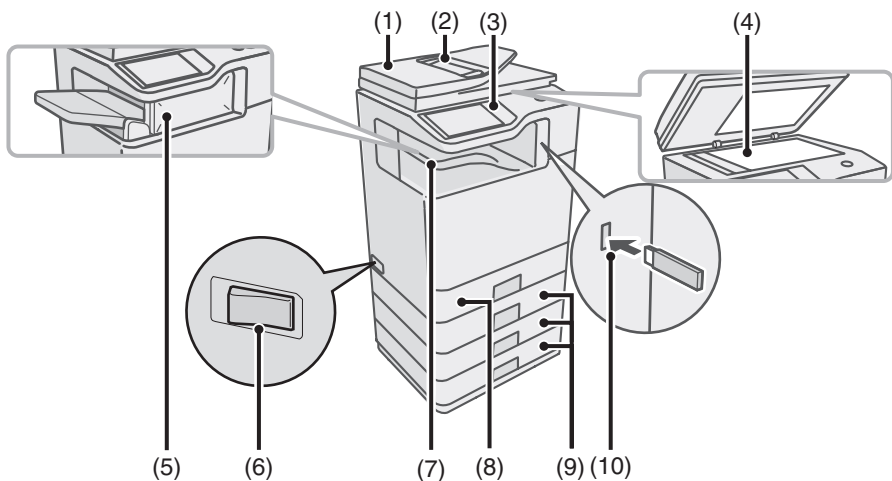

**(1) Automatic document feeder**

This automatically feeds and scans multiple originals. Both sides of 2-sided originals can be scanned at once.

**(2) Document feeder tray**

Place the originals in this tray when using the automatic document feeder.

**(3) Operation panel**

**(4) Document glass**

This is used to scan books and other originals that cannot be scanned using the automatic document feeder.

**(5) Finisher\***

This can be used to staple output.

**(6) Main power switch**

This is used to power on the machine. When using the fax or Internet fax functions, keep this switch in the "on" position.

**(7) Output tray (center tray)**

Copy jobs and print jobs are delivered to this tray. (When a finisher is installed, the output tray (center tray) cannot be used.)

**(8) Tray 1**

Up to 500 sheets of paper (21 lbs. (80 g/m<sup>2</sup>)) can be loaded in each tray.

**(9) Tray 2/Tray 3/Tray 4 (500 sheet paper feed unit is installed)\***

This holds paper. Up to 500 sheets (21 lbs. (80 g/m<sup>2</sup>)) of paper can be loaded.

**(10) USB connector (type A)**

Supports USB 2.0 (Hi-Speed). This is used to connect a USB memory or other USB device to the machine.

\* Peripheral device. For more information, see "PERIPHERAL DEVICES" in "Chapter 1 - BEFORE USING THE MACHINE" in the Operation Guide.

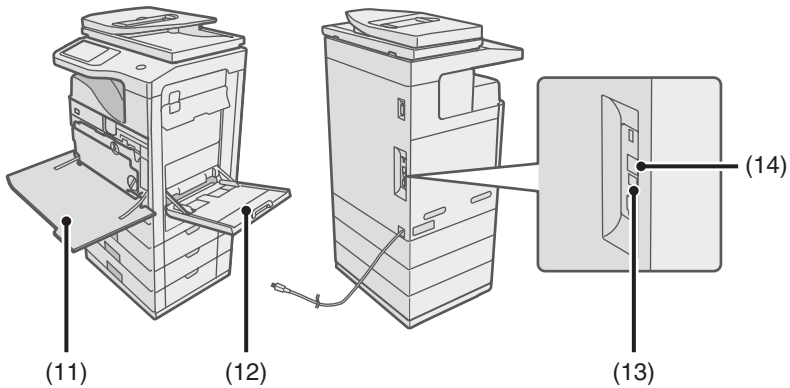

**(11) Front cover**

Open to replace a toner cartridge.

**(12) Bypass tray**

Special types of paper and envelopes can be fed from the bypass tray.

**(13) USB connector (B type)**

Supports USB 2.0 (Hi-Speed). A computer can be connected to this connector to use the machine as a printer.

**(14) LAN connector**

Connect the LAN cable to this connector when the machine is used on a network.

# SUPPLIES

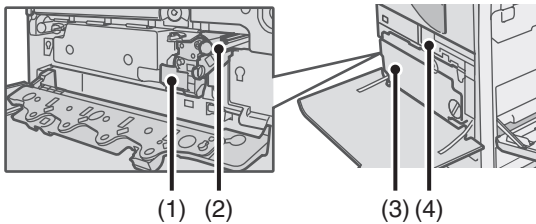

**(1) Developer cartridge**

This contains the developer that is necessary to transfer the toner to the paper.

**(2) Drum cartridge**

This contains the photosensitive drum that is used to create images for copying and printing.

**(3) Toner collection container**

This collects excess toner that remains after printing.

**(4) Toner cartridge**

This contains toner for printing. When the toner runs out in a cartridge, the cartridge must be replaced.

# OPERATION PANEL

## Image send indicators

### LINE indicator

This lights up during transmission or reception in fax mode. The indicator also lights up during transmission in scan mode.

### DATA indicator

When a received fax cannot be printed because of a problem such as out of paper, the indicator blinks. The indicator lights steadily when there is data that is waiting to be transmitted.

## Touch panel

Messages and keys appear in the LCD display. Operations are performed by touching the keys with your finger.

## [JOB STATUS] key

Press this key to view the job status screen. You can check the status of jobs and cancel jobs in the job status screen.

## Print mode indicators

### READY indicator

Print data can be received when this indicator is lit.

### DATA indicator

This blinks while print data is being received and lights steadily while printing is taking place.

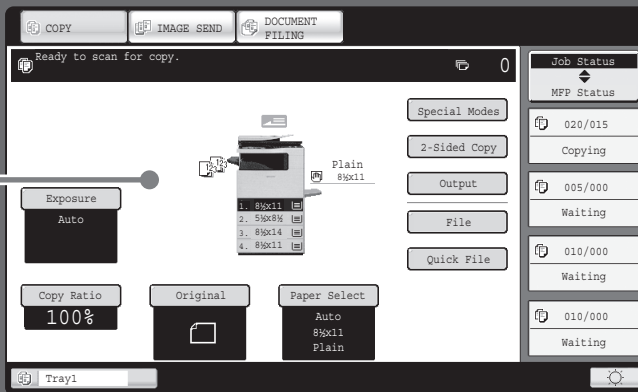

JOB STATUS

SYSTEM SETTINGS

PRINT = READY  
= DATA

IMAGE SEND = LINE  
= DATA

HOME

## [SYSTEM SETTINGS] key

Press this key to display the system settings screen. The system settings can be adjusted to make the machine easier to use, such as configuring paper tray settings and storing addresses.

## [HOME] key

Touch this key to display the home screen. The base screen of each mode is opened from the home screen.

### Numeric keys

These are used to enter the number of copies, fax numbers, and other numbers.

#### [LOGOUT] key ( \* )

When user authentication is enabled, press this key to log out after using the machine. When using the fax function, this key can be pressed to send tone signals on a pulse dial line.

#### [#/P] key ( #/P )

Press this key to use a job program when using the copier function. When using the fax function, this key can be used when dialing.

### [CLEAR] key

Press this key to return settings such as the number of copies to "0".

### Main power indicator

This indicator lights when the main power is switched on. The main power switch is on the left side of the machine.

### [POWER] key

Use this key to turn the machine power on and off.

### [POWER SAVE] key

Use this key to activate power save mode. The [POWER SAVE] key blinks when the machine is in power save mode. This key is also used to deactivate power save mode.

### [START] key

Use this key to copy or scan an original. This key is also used to send a fax in fax mode.

### [CLEAR ALL] key

Press this key to redo an operation from the beginning. All settings will be cleared and operation will return to the initial state.

### [STOP] key

Press this key to stop a copy job or scanning of an original.

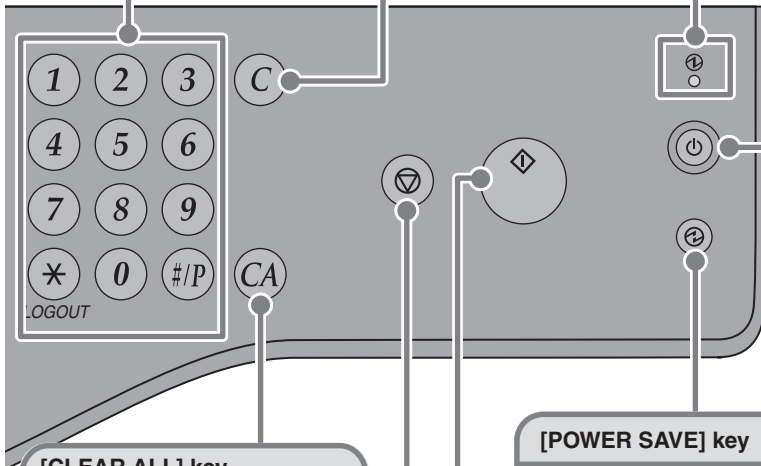

# USING THE TOUCH PANEL

The touch keys that appear in the touch panel are grouped for easy operation. The layout and functions of the touch keys are explained below.

## Mode select keys

### [COPY] key

To use the copy function, touch this key to switch to copy mode. Keep your finger on the [COPY] key to view the machine's total page use count and amount of toner remaining.

### [IMAGE SEND] key

To use the scan or fax function, touch this key to switch to image send mode.

### [DOCUMENT FILING] key

When you wish to print or send a file stored on the hard drive, touch this key to switch to document filing mode.

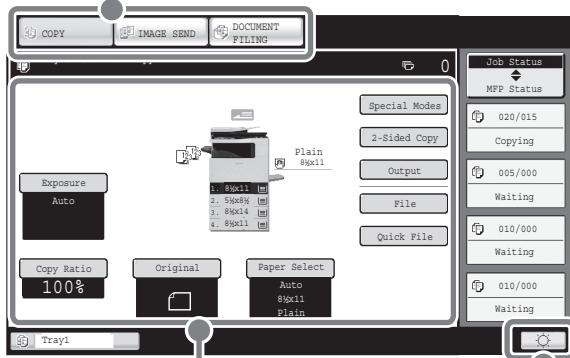

When the mode of the machine is changed, the base screen of the newly selected mode appears. Functions can be selected and settings checked in the base screen.





## Brightness adjustment key

Touch this key to adjust the brightness of the touch panel.

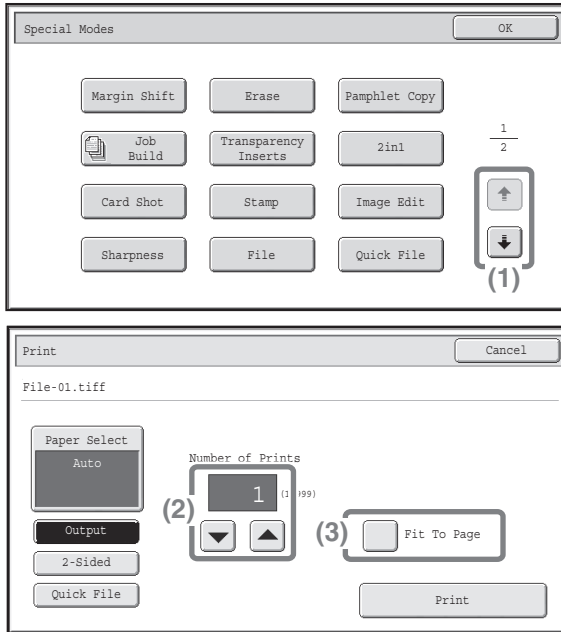

## Using general keys



- (1) When the displayed screen is one of two or more screens, use the   keys to switch through the screens.
- (2) The   keys can be used to increase or decrease a value. To make a value change quickly, keep your finger on the key. You can also directly touch a numeric value display key to change a number with the numeric keys.
- (3) When a checkbox  is touched, a checkmark  will appear to indicate that the setting is enabled.

# Checking the status of the machine

The touch panel has a key for checking the status of the machine.

## "Job Status" display

This shows the first 4 print jobs in the print queue (the job in progress and jobs waiting to be printed). The type of job, the set number of copies, the number of copies completed, and the job status appear.

## Display selection key

The status display can be switched between "Job Status" and "MFP Status". If the job status screen is displayed, the status display automatically changes to the "MFP Status".

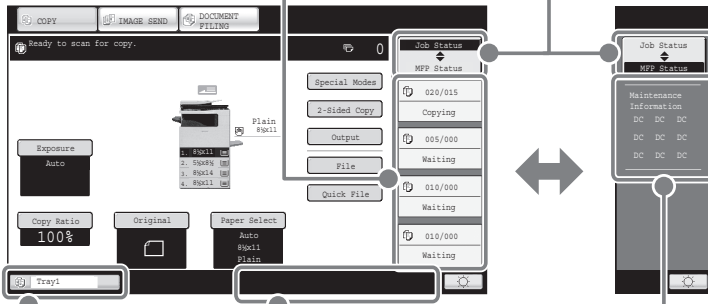

## System display

The USB device connection status and communication status are shown as icons.

## "MFP Status" display

This shows machine system information.

### "Maintenance Information"

This shows machine maintenance information by means of codes.

## Job status display

The mode icon of the reserved job or job in progress, the tray being used to feed paper, and the job status appear. This can be touched to show the job status screen.

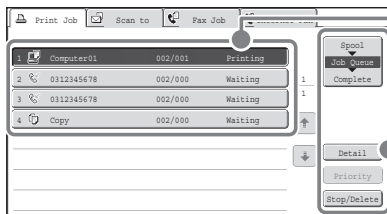

Jobs are displayed as a list of touch keys. The job keys appear in the order that they will be run. A job key can be touched to select it.

A selected job can be given priority and run ahead of other jobs, or a job waiting in the queue can be canceled.

# USER AUTHENTICATION

When user authentication is enabled in the system settings, you must log in before using the machine. User authentication is initially disabled. When you have finished using the machine, log out.

## User authentication methods

There are two methods for performing user authentication: login by user number and login by login name and password. Ask the administrator of the machine for the information that is required to log in.

For details on user authentication, see "USER AUTHENTICATION" in "Chapter 1 - BEFORE USING THE MACHINE" in the Operation Guide.

### Login by user number



The screenshot shows a dialog box titled "User Authentication" with an "OK" button in the top right corner. In the center, there is a small icon of a printer. Below the icon is a text input field containing a series of dashes (password mask). At the bottom right of the dialog box, there is a button labeled "Admin Login".

This method requires that you log in by entering your user number (5 to 8 digits), which is stored in the system settings of the machine.

### Login by login name and password

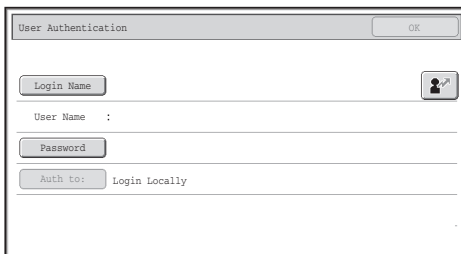

The screenshot shows a dialog box titled "User Authentication" with an "OK" button in the top right corner. It contains several input fields: a "Login Name" field with a user icon button to its right, a "User Name" field with a colon to its right, a "Password" field, and an "Auth to:" field with "Login Locally" selected. There is also an empty field below the "Auth to:" field.

This method requires that you log in by entering your login name, password, and the login destination, which are stored in the system settings of the machine. Depending on how the machine administrator has configured the system settings, an e-mail address may also be used for authentication.

# Logging out

When you have finished using the machine, log out. Logging out prevents unauthorized use of the machine.

## How to log out

You can log out from any mode of the machine by pressing the [LOGOUT] key (⊛). However, note that the [LOGOUT] key (⊛) cannot be used to log out when a fax number is being entered in fax mode, as the [LOGOUT] key (⊛) functions as a numeric key at this time.

If a preset duration of time elapses after the machine is last used, the auto clear function will activate. When auto clear activates, logout automatically takes place.

# HOME SCREEN

When the [HOME] key is pressed on the operation panel, the home screen appears in the touch panel. Mode selection keys appear in the home screen. These keys can be touched to open the base screen of each mode. The [My Menu] key can be touched to display shortcuts to functions stored in "My Menu".

## 1st screen

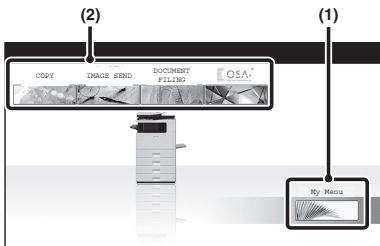

## 2nd screen

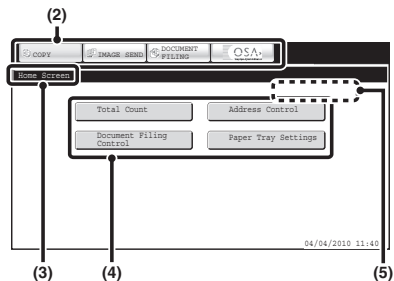

### (1) [My Menu] key

Touch this to move to the second home screen.

### (2) Mode select keys

Use these keys to switch between copy, image send, document filing, and Sharp OSA modes.

### (3) Title

This shows the title of the home screen.

### (4) Shortcut key

A registered function appears as a shortcut key. The key can be touched to select the registered function.

### (5) User name

This shows the name of the logged in user. The user name appears when user authentication is enabled on the machine.

Register frequently used functions in the home screen to quickly and conveniently access those functions.

Register keys that you wish to show in the home screen in the system settings.

For details on home screen settings, see "Favorite Operation Group Registration" and "Home Screen Settings" in "Chapter 7 - SYSTEM SETTINGS" in the Operation Guide.

# IMAGE CHECK FUNCTION (PREVIEW)

The image check function is used to display the content of a received fax or other data in the touch panel.

## Convenient uses of image check

### "Printing only faxes that are needed"

You can check a received fax before printing it. If you don't need the fax, you can delete it without printing it, allowing you to save paper and toner.

### "Checking the content of a file stored in the machine"

Before printing or sending a file stored using the document filing function, you can check the content of the file. A preview can be displayed directly from the Job Settings menu, making it easy to move from image preview to execution of the job.

## Data that can be checked

The image check function can be used to check the following types of data:

- Faxes received in fax mode
- Faxes received in Internet fax mode
- Faxes stored in a memory box
- Files stored using the document filing function

\* The key names in the image check screen and the procedures for using the screen vary depending on the image type.

When the image check function is used, a screen similar to the following screen appears.

**The content of the data appears here  
In the touch panel,  
you can**

- **Scroll the display**
- **Change pages**
- **Change the display magnification**

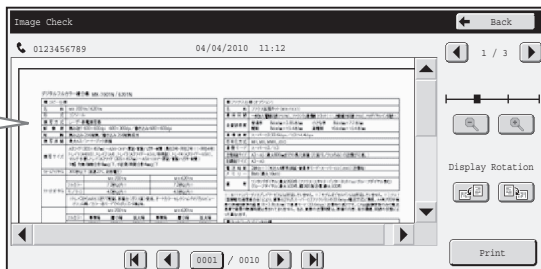

### **Example: The image check screen for a received fax**

For details on the image check function, see each of the modes in the Operation Guide.

\* A preview image is an image for display on the touch panel. It will differ from the actual print result.

After checking a received fax with this function, either print the fax or delete it so that the fax data does not remain.

# PLACING ORIGINALS

The automatic document feeder can be used to automatically scan many originals at once. This saves you the trouble of manually feeding each original. For originals that cannot be scanned using the automatic document feeder, such as a book or a document with notes attached, use the document glass.

## Using the automatic document feeder

When using the automatic document feeder, place the originals in the document feeder tray.

Make sure an original has not been placed on the document glass.

Adjust the original guides to the width of the originals.

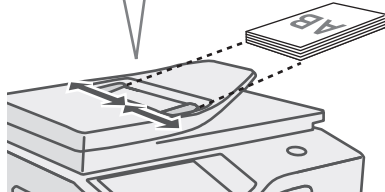

Place the originals face up with the edges aligned evenly.

▼ ▼ The indicator line indicates approximately how many originals can be placed. The placed originals must not be higher than this line.

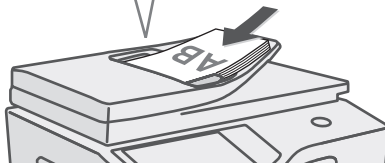

## Using the document glass

Take care that your fingers are not pinched when closing the automatic document feeder.

After placing the original, be sure to close the automatic document feeder. If left open, parts outside of the original will be copied black, causing excessive use of toner.

Place the original face down.

Align the middle of the original with the tip of the ► mark in the center of the glass.



Place the original face down.

To place a thick original such as a book, push up the far edge of the automatic document feeder and then close the automatic document feeder slowly. Do not press hard on the automatic document feeder. This may cause failure.





Place the original in the horizontal orientation, referring to the document glass scale.

### Originals



Portrait original

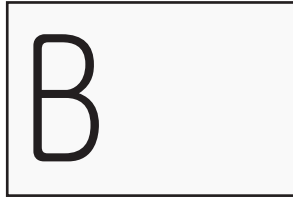

Landscape original

### Document glass scale

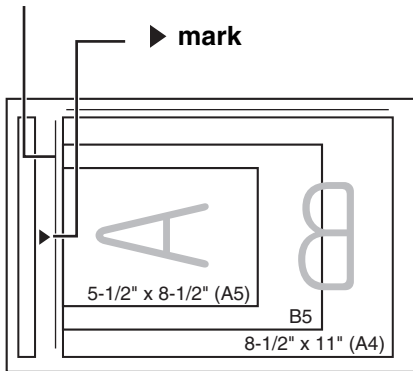

### Portrait originals

When using the below functions in copy mode, place the original so that the top of the image is to the right.

- Staple sort
- Pamphlet copy
- 2in1
- Stamp

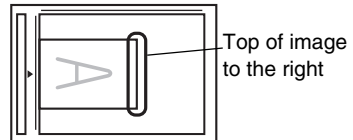

### Landscape originals

When using the staple sort function, place the original so that the top of the image is toward you.

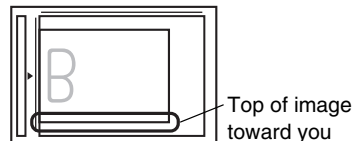

For more information, see "ORIGINALS" in "Chapter 1 - BEFORE USING THE MACHINE" in the Operation Guide.

# CHANGING PAPER IN A TRAY

## Names of the trays

The names of the trays are shown below.

For the number of sheets of paper that can be loaded in each tray, see the following manuals:

- Operation Guide, "Paper Tray Settings" in "Chapter 7 - SYSTEM SETTINGS"
- Maintenance & Safety Guide, "SPECIFICATIONS"

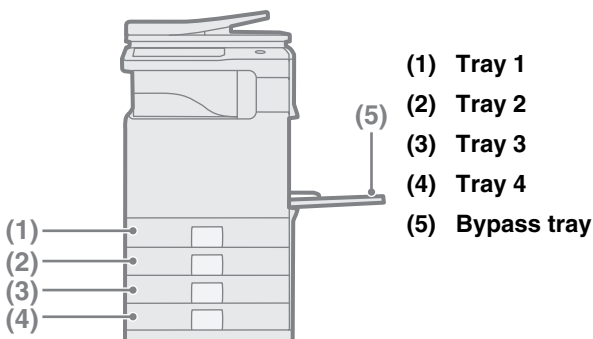

## Print side face up or face down

Paper is loaded with the print side face up or face down depending on the paper type and tray.

Tray	Print side*
Tray 1 to 4	Face up
Bypass tray	Face down

\* When loading "Pre-Punched", "Letter Head", or "Pre-Printed" paper in the paper tray, the direction the print side faces is different.

For more information, see "LOADING PAPER" in "Chapter 1 - BEFORE USING THE MACHINE" in the Operation Guide.

## Loading paper in a tray

To change the paper in a tray, load the desired paper in the tray and then change the tray settings in the machine to specify the loaded paper. The procedure for changing the tray paper size is explained below. As an example, the paper in tray 1 is changed from 8-1/2" x 11" (A4) size plain paper to 5-1/2" x 8-1/2" (A5) size recycled paper.

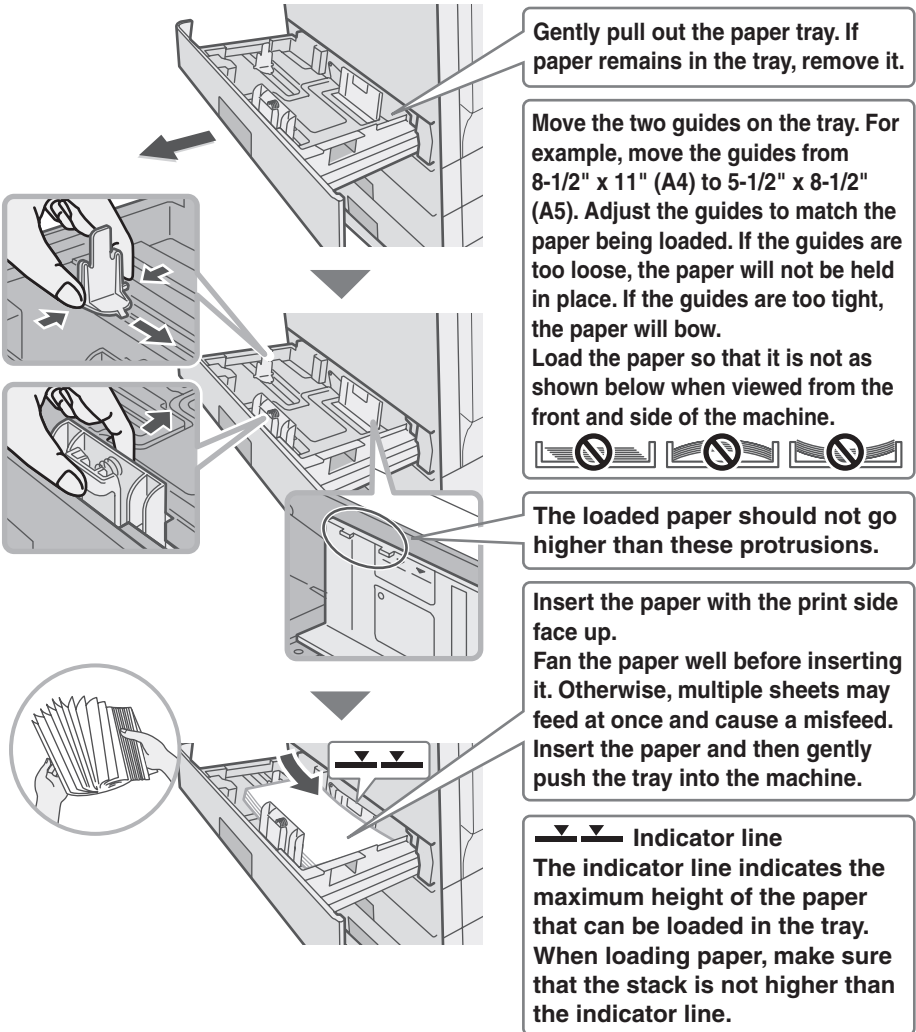

# Changing the tray settings

When you change the paper in a tray, the tray settings in the system settings must also be changed.

SYSTEM  
SETTINGS

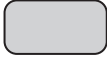

**1** Press the [SYSTEM SETTINGS] key.

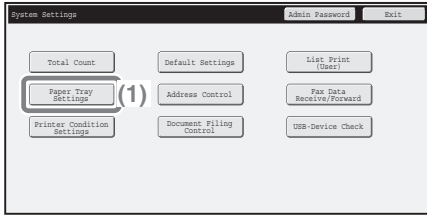

**2** Configure the tray settings in the touch panel.

(1) Touch the [Paper Tray Settings] key.

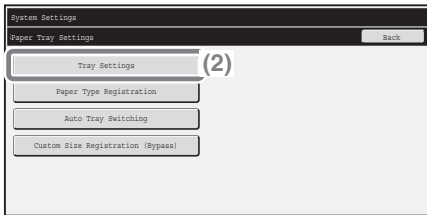

(2) Touch the [Tray Settings] key.

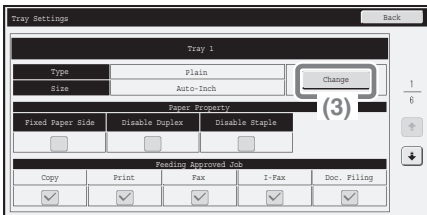

(3) Touch the [Change] key in "Tray 1".

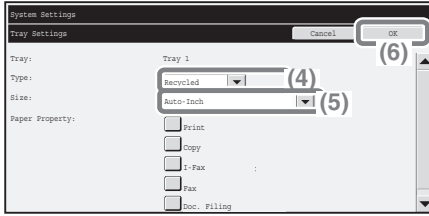

Select settings in the touch panel. (Continued)

(4) Select [Recycled] from the "Type" select box.

(5) Make Sure that [Auto-Inch] is selected in the "Size" select box.

For more information, see "Paper Tray Settings" in "Chapter 7 - SYSTEM SETTINGS" in the Operation Guide.

(6) Touch the [OK] key.

The above steps change the paper settings for tray 1 to 5-1/2" x 8-1/2" recycled paper.

## Loading paper in bypass tray

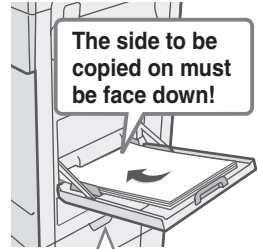
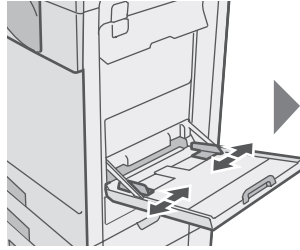
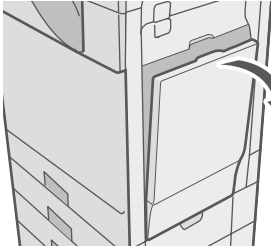

Load the paper in the horizontal orientation.

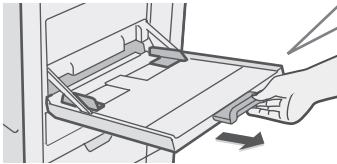

When loading 8-1/2" x 11" size paper, pull out the tray extension. The maximum number of sheets that can be loaded in the bypass tray is approximately 100 for plain paper and approximately 20 for envelopes.

### Example: Loading an envelope

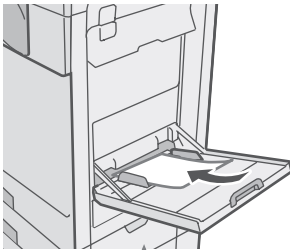

Place paper that is 7-1/4" x 10-1/2" (A5) or smaller in the horizontal orientation.

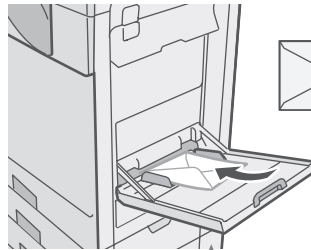

Only the address side of envelopes can be printed on. Place envelopes with the address side face down.

Do not place heavy objects on the bypass tray or press down on the tray. The bypass tray may be damaged, the machine may topple, and injury may result. Special types of paper that cannot be loaded in other trays can be loaded in the bypass tray.

For detailed information on the bypass tray, see "LOADING PAPER IN THE BYPASS TRAY" in "Chapter 1 - BEFORE USING THE MACHINE" in the Operation Guide.

# Copying

This section explains the basic procedures for using the copier function. This section also introduces the various types of copying that can be performed using the special modes.

- ▶ **BASE SCREEN OF COPY MODE** . . . . . 30
- ▶ **MAKING COPIES** . . . . . 32
- ▶ **2-SIDED COPYING (Automatic Document Feeder)** . . . . 34
- ▶ **COPYING ON SPECIAL PAPER (Bypass Copy)** . . . . . 36
- ▶ **SELECTING THE EXPOSURE AND IMAGE TYPE** . . . . . 39
- ▶ **FITTING THE COPY IMAGE TO THE PAPER  
(Automatic Ratio Selection)** . . . . . 41
- ▶ **ENLARGEMENT/REDUCTION (Preset Ratios /  
Zoom)** . . . . . 43
- ▶ **INTERRUPTING A COPY RUN (Interrupt Copy)** . . . . . 45
- ▶ **STORING COPY OPERATIONS (Job Programs)** . . . . . 46
- ▶ **SPECIAL MODES** . . . . . 49
- ▶ **SELECTING A SPECIAL MODE** . . . . . 50
- ▶ **CONVENIENT COPY FUNCTIONS** . . . . . 52

# BASE SCREEN OF COPY MODE

Touch the [COPY] key in the touch panel to open the base screen of copy mode.

Select copy settings in the base screen.

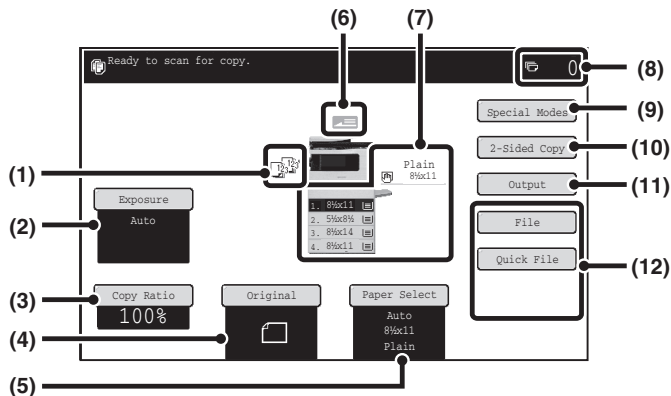

## (1) Output display

When one or more output functions such as sort, group, or staple sort have been selected, this shows the icons of the selected functions.

## (2) [Exposure] key

This shows the current copy exposure and exposure mode settings. Touch this key to change the exposure or exposure mode setting.

## (3) [Copy Ratio] key

This shows the current copy ratio. Touch this key to adjust the copy ratio.

## (4) [Original] key

Touch this key to enter the original size manually. After placing the original, touch this key to set the original size.

## (5) [Paper Select] key

Touch this key to change the paper (tray) that is used. The tray, paper size, and paper type will appear. The tray images in the paper size display can be selected to open the same screen.

## (6) Original feed display

This appears when an original is inserted in the automatic document feeder.



**(7) Paper select display**

This shows the size of paper loaded in each tray and the amount of paper remaining .

The selected tray is highlighted.

**The tray that is feeding paper is indicated in green.**

**Do not pull out a tray while paper is being fed from the tray. This will cause a paper misfeed.**

**(8) Number of copies display**

This shows the number of copies set.

**(9) [Special Modes] key**

Touch this key to select special modes such as Margin Shift, Erase, and Pamphlet Copy.

**(10) [2-Sided Copy] key**

Touch this key to select the 2-sided copying function.

**(11) [Output] key**

Touch this key to select an output function such as sort, group, offset, or staple sort.

**(12) Customized keys**

The keys that appear here can be changed to show settings or functions that you prefer.

# MAKING COPIES

This is the most basic procedure for making copies.

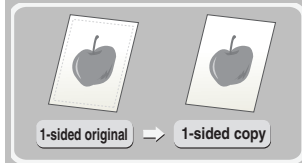

The side to be scanned must be face up!



## 1 Place the originals.

When using the document glass, place the original with the side to be scanned face down.

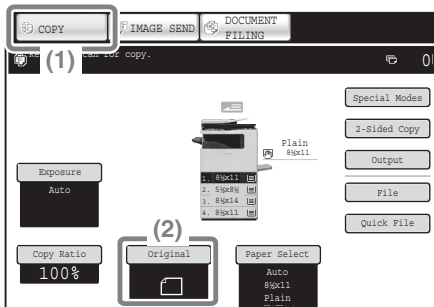

## 2 Select settings in the touch panel.

### (1) Touch the [COPY] key.

The base screen of copy mode appears.

### (2) Touch the [Original] key.

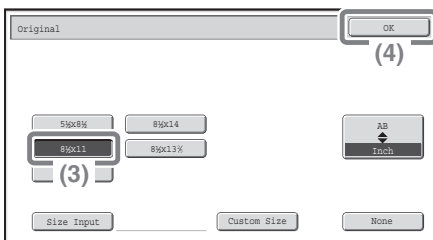

### (3) Touch the [8-1/2 x 11] key.

Select the size of the original.

### (4) Touch the [OK] key.

Select settings in the touch panel. (Continued)

(5) Make sure that the desired paper size is selected.

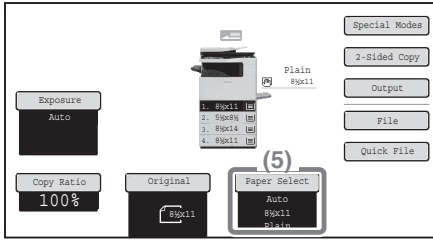

**3** Set the number of copies and then press the [START] key.

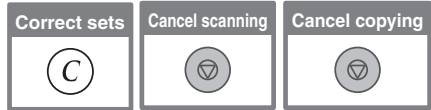
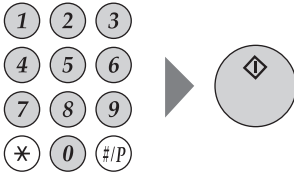

# 2-SIDED COPYING (Automatic Document Feeder)

You can use the automatic document feeder to make automatic 2-sided copies without the bother of manually turning the originals over and re-inserting them. This section explains how to copy 1-sided originals onto both sides of the paper.

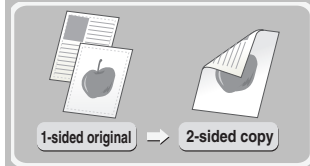

The side to be scanned must be face up!

## 1 Place the originals.

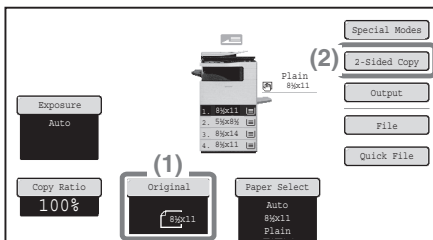

## 2 Select settings in the touch panel.

- (1) Set the original size.
- (2) Touch the [2-Sided Copy] key.

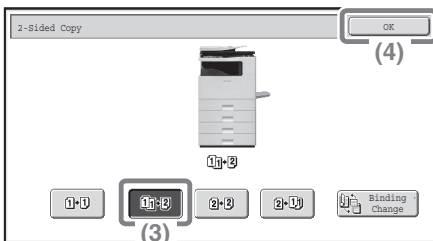

- (3) Touch the [1-Sided to 2-Sided] key.
- (4) Touch the [OK] key.

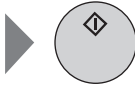
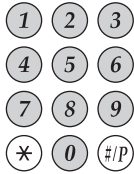

**3 Set the number of copies and then press the [START] key.**

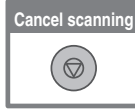
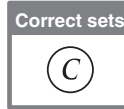

# COPYING ON SPECIAL PAPER (Bypass Copy)

Use the bypass tray to copy on special media such as heavy paper, and envelopes. This section explains how to load 8-1/2" x 11" heavy paper in the bypass tray.

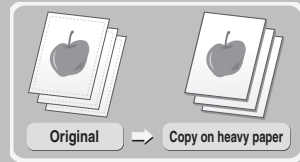

The side to be scanned must be face up!



## 1 Place the originals.

When using the document glass, place the original with the side to be scanned face down.

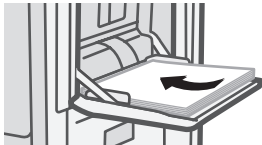

The side to be copied on must be face down!

## 2 Insert paper in the bypass tray.

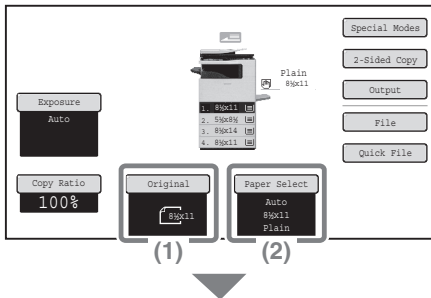

## 3 Select settings in the touch panel.

(1) Set the original size.

(2) Touch the [Paper Select] key.

(3) Touch the paper type key of the bypass tray.

Here the [Plain] key has been touched.

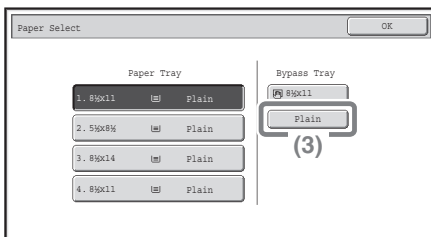

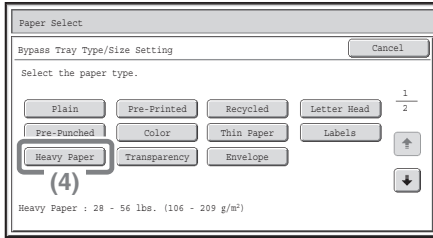

Select settings in the touch panel. (Continued)  
**(4) Touch the [Heavy Paper]**  
**key.**

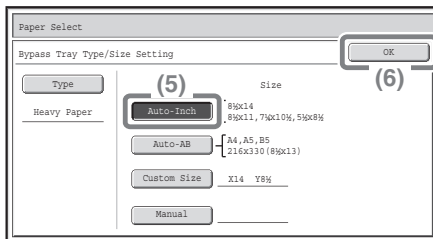

**(5) Touch the [Auto-Inch]**  
**key.**  
**(6) Touch the [OK]**  
**key.**

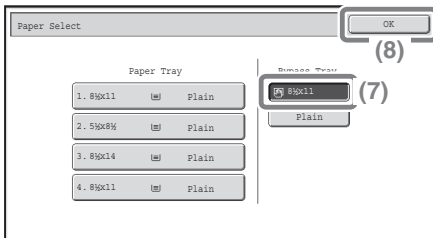

**(7) Touch the bypass tray key.**  
**(8) Touch the [OK]**  
**key.**

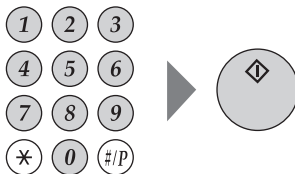

**4 Set the number of copies**  
**and then press the [START]**  
**key.**

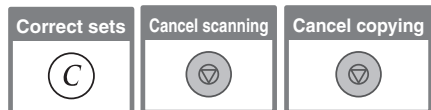

# Selecting a tray

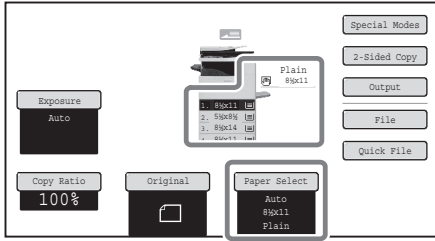

To select paper, touch the [Paper Select] key or the image of the machine in the base screen of copy mode.

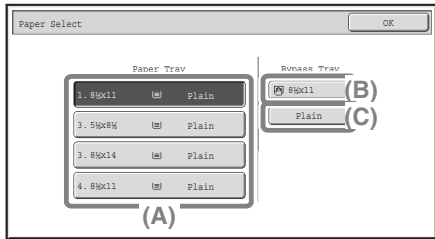

Touch a key to select a tray.  
(A) Touch to select one of trays 1 to 4.  
(B) Touch to select the bypass tray.  
(C) Touch to set the type of paper in the bypass tray.



# SELECTING THE EXPOSURE AND IMAGE TYPE

You can specify the original image type to obtain a clearer copy.  
The example of copying an original with light colors such as pencil writing is explained below.

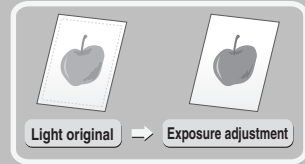

The side to be scanned must be face up!



## 1 Place the originals.

When using the document glass, place the original with the side to be scanned face down.

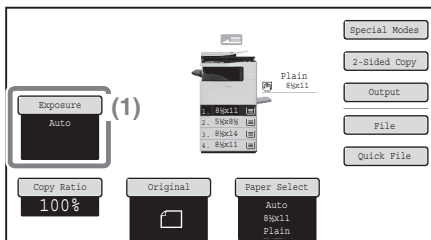

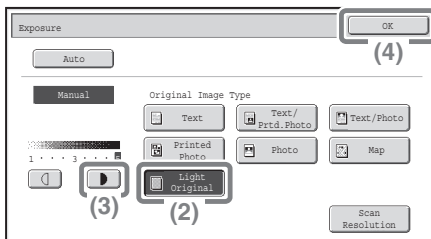

## 2 Select settings in the touch panel.

(1) Touch the [Exposure] key.



(2) Touch the [Light Original] key.

(3) Darken the printed result with the  key.

Nine levels are available for the exposure. Darken light originals with the  key, and lighten dark originals with the  key.

(4) Touch the [OK] key.

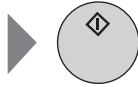
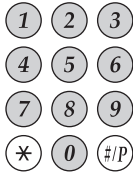

**3 Set the number of copies and then press the [START] key.**

Correct sets



Cancel scanning



Cancel copying



# FITTING THE COPY IMAGE TO THE PAPER (Automatic Ratio Selection)

You can copy an original onto any size of paper using automatic enlargement/reduction. This section explains how to copy a 5-1/2" x 8-1/2" original onto 8-1/2" x 14" paper.

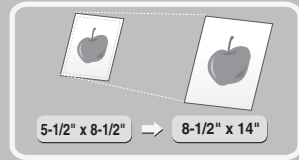

## The side to be scanned must be face up! **1 Place the originals.**



When using the document glass, place the original with the side to be scanned face down.

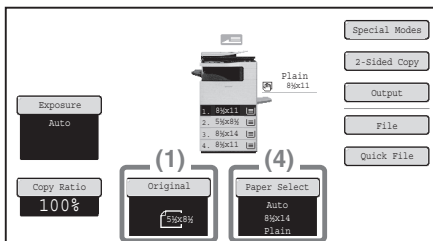

## **2 Select settings in the touch panel.**

(1) Touch the [Original] key.

(2) Touch the [5-1/2 x 8-1/2] key.

(3) Touch the [OK] key.

(4) Touch the [Paper Select] key.

(5) Touch the tray that has the desired paper size.

(6) Touch the [OK] key.

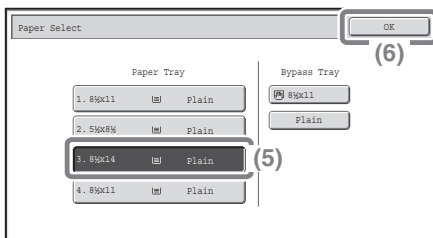

Select settings in the touch panel. (Continued)  
(7) Touch the [Auto Image] key.

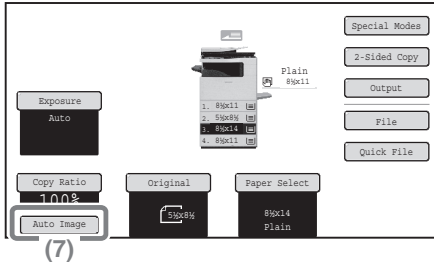

**3** Set the number of copies.

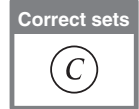
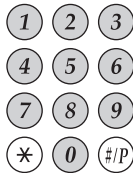

**4** Press the [START] key.

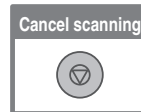

# ENLARGEMENT/REDUCTION (Preset Ratios / Zoom)

For precise adjustment of the copy size, you can select a preset ratio and/or adjust the ratio in increments of 1%.  
As an example, this section explains how to reduce the image to 55%.

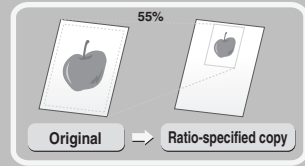

The side to be scanned must be face up!



## 1 Place the originals.

When using the document glass, place the original with the side to be scanned face down.

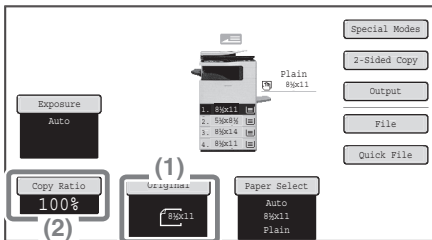

## 2 Select settings in the touch panel.

(1) Set the original size.  
(2) Touch the [Copy Ratio] key.

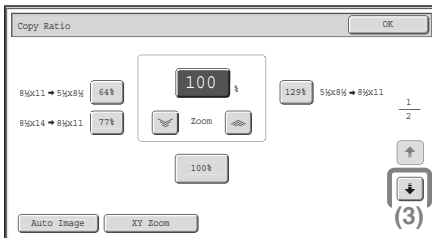

(3) Touch the  key.

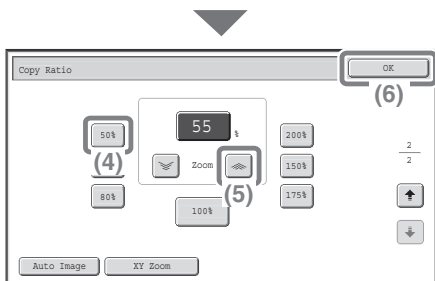



## Select settings in the touch panel. (Continued)

### (4) Touch the [50%] key.

Touch the preset ratio key that is closest to 55% (the desired ratio).

### (5) Set the copy ratio to 55% with the key.

The  key decreases the ratio in increments of 1%, and the  key increases the ratio in increments of 1%.

### (6) Touch the [OK] key.

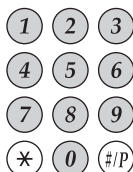

## 3 Set the number of copies.

Correct sets



## 4 Press the [START] key.



Cancel scanning



Cancel copying



# INTERRUPTING A COPY RUN (Interrupt Copy)

When the machine is printing, you can temporarily interrupt the job and perform a copy job that you wish to prioritize. This feature is useful when you need to make an urgent copy during a long copy run.

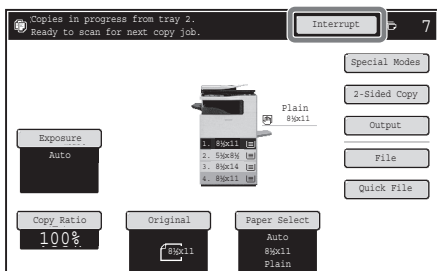
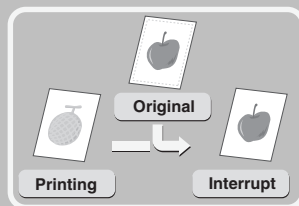

## 1 Touch the [Interrupt] key while the machine is printing.

The [Interrupt] key appears in the base screen while the machine is printing.

The side to be scanned must be face up!



## 2 Place the originals.

When using the document glass, place the original with the side to be scanned face down.

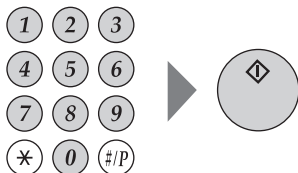

## 3 Set the number of copies and then press the [START] key.

The interrupted copy job will resume when the copy job is finished.

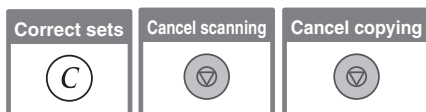

# STORING COPY OPERATIONS (Job Programs)

You can store a group of copy settings. The settings can be retrieved and used whenever needed.

When you frequently use the same group of settings, this saves you the trouble of manually selecting the settings each time you need to use them.

## Storing a job program

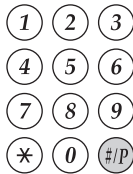

**1** Press the [# / P] key (Ⓢ).

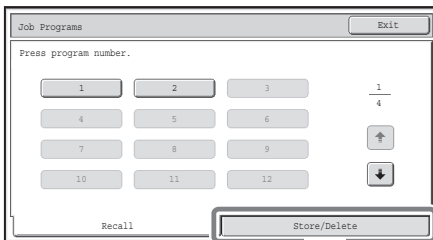

**2** Select settings in the touch panel.

**(1)** Touch the [Store/Delete] tab.

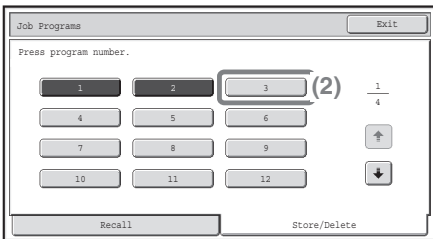

**(2)** Touch the key in which you want to store a job program.

Touch any key that is not highlighted.

Keys that have a job program stored are highlighted.



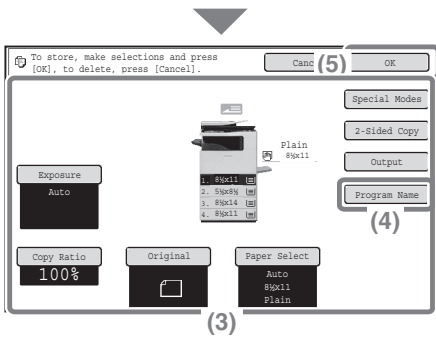

Select settings in the touch panel. (Continued)

(3) Select the copy settings that you wish to store.

(4) Touch the [Program Name] key.

A text entry screen appears. Enter a name for the program.

(5) Touch the [OK] key.

## Using a job program

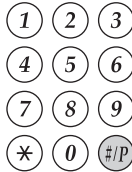

1 Press the [#]/P key (#/P).

Place the original.

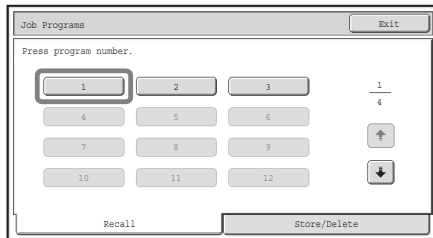

2 Touch the key of the desired job program.

After selecting the job program, set the number of copies and press the [START] key to begin copying.

## Deleting a job program



1 Press the [#]/P key (#/P).

## 2 Select settings in the touch panel.

(1) Touch the [Store/Delete] tab.

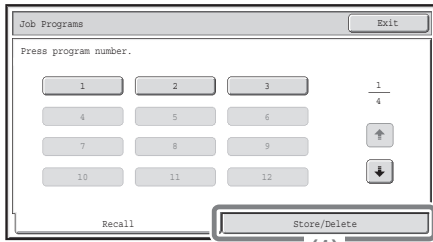

(2) Touch the key of the job program that you wish to delete.

Touch a key that is highlighted. Keys that have a job program stored are highlighted.

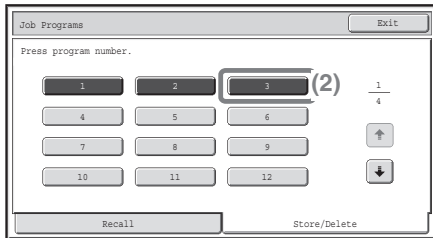

(3) Read the displayed message and touch the [Delete] key.



(4) Touch the [Exit] key.

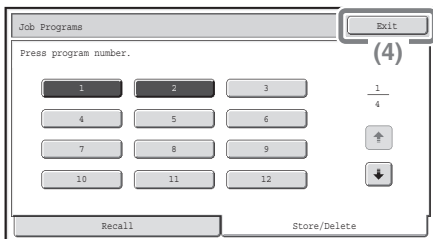

# SPECIAL MODES

The special modes can be used for a variety of special-purpose copy jobs. This section introduces the types of copies that can be made with the special modes. (The procedures for using each special mode are not explained.) Each special mode has its own settings and steps, however, the basic procedure is the same for all modes. The basic procedure for selecting a special mode is explained on the next page using "Margin Shift" as an example. **For the procedures for using the special modes, see "SPECIAL MODES" in "Chapter 2 - COPIER" in the Operation Guide.**

## Special modes

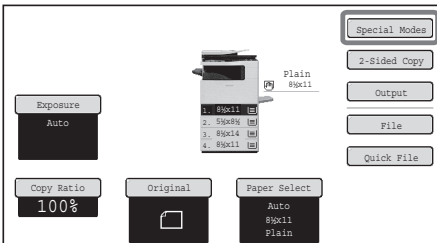

To use a special mode, open the special modes menu, and touch the key of mode that you wish to use. The menu consists of two screens. Use the keys to switch between the screens.

Touch the [Special Modes] key in the base screen to open the special modes menu.

### 1st screen

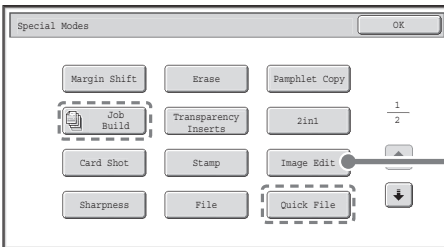

### Image edit menu screen

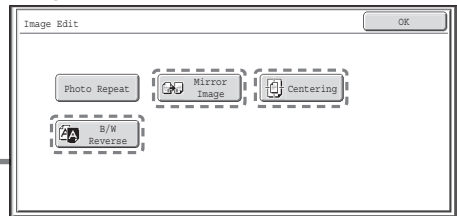

### 2nd screen

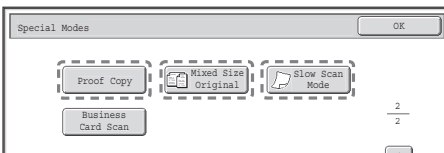

When a special mode key encircled by is touched, the key is highlighted and the setting is completed.

When any other special mode key is touched, a screen appears to let you select settings for that mode.

Note that the keys that appear will vary depending on what peripheral devices are installed.

# SELECTING A SPECIAL MODE

The procedure for selecting settings for "Adding margins (Margin Shift)" is explained below as an example. Although the specific settings for each special mode vary, the general procedure is the same.

The side to be scanned must be face up!



## 1 Place the originals.

When using the document glass, place the original with the side to be scanned face down.

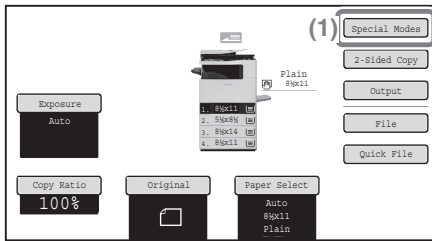

## 2 Select settings in the touch panel.

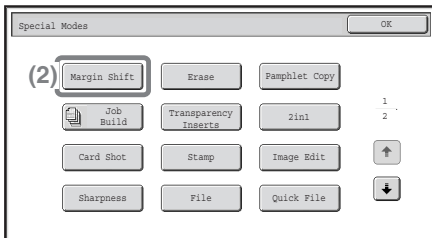

(1) Touch the [Special Modes] key.

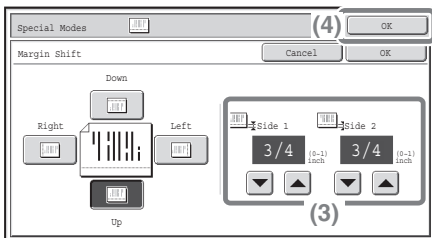

(2) Touch the [Margin Shift] key.

Settings to shift the margin 3/4" down will be selected.



(3) Select 3/4" for the front side and 3/4" for the reverse side using the   keys.

The margin shift position is initially set to "Up".

To set the margin shift position to "Right", "Left", or "Down", touch the corresponding key.

(4) Touch the [OK] key.

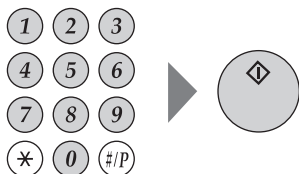

**3 Set the number of copies and then press the [START] key.**

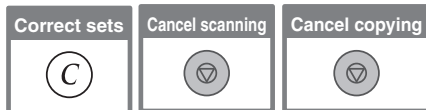

# CONVENIENT COPY FUNCTIONS

## Adding margins (Margin Shift)

Use this function to shift the image on the copy to create binding margins.

This function is convenient when you wish to hole punch the copies.



## Erasing peripheral shadows (Erase)

Use this function to erase peripheral shadows that occur when making copies of books and other thick originals.

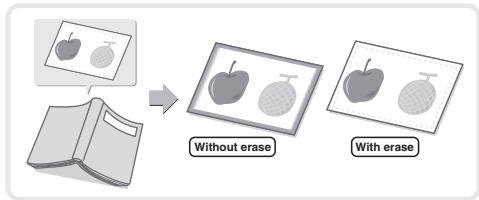

## Making copies in pamphlet format (Pamphlet Copy)

Use this function to make copies that can be folded into a pamphlet.

Pamphlet copy makes it easy to create pamphlets.

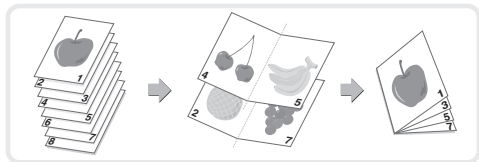

## Copying a large number of originals at once (Job Build)

A stack of originals higher than the indicator line on the automatic document feeder cannot be fed through the feeder.

The job build function lets you divide the stack of originals into sets, feed each set, and copy the sets as a single job.

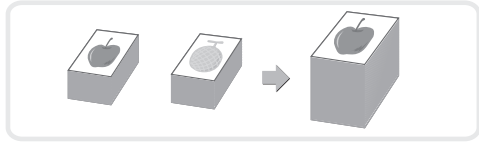

## Adding inserts when copying on transparency film (Transparency Inserts)

When copying onto transparency film, this function inserts sheets of paper between the sheets of transparency film to keep them from sticking together.

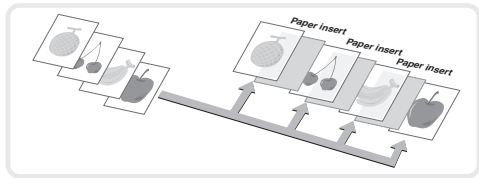

## Copying two original pages onto one sheet of paper (2in1)

Use this function to copy two original pages onto one sheet of paper.

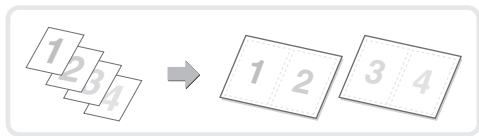

## Copying both sides of a card onto one sheet of paper (Card Shot)

Use this function to copy the front and reverse side of a card onto one sheet of paper.

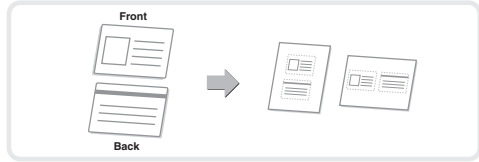

## Printing the date or a stamp on copies (Stamp)

Use this function to print the date, a stamp, the page number, or text on copies.

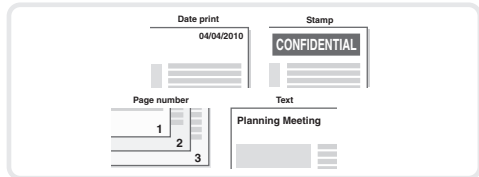

## Repeating photos on a copy (Photo Repeat)

Use this function to print up to 12 copies of one photo on one sheet of paper.

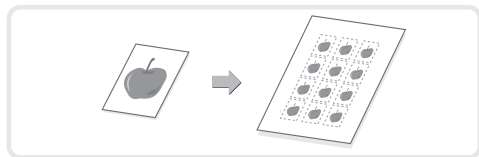

## Inverting the image (Mirror Image)

Use this function to make a copy that is a mirror image of the original.





## Copying in the center of the paper (Centering)

Use this function to position the copy image at the center of the paper.

This is convenient when the image is reduced or copied onto paper that is larger than the original.

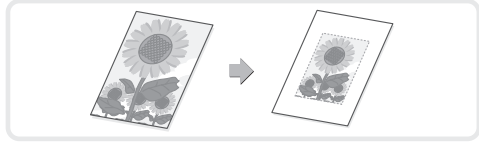

## Reversing black and white in a copy (B/W Reverse)

This function reverses black and white in a copy to create a negative image.

Use this function to save toner when copying an original with large black areas.

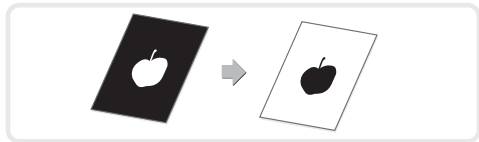

## Adjusting the sharpness of an image (Sharpness)

Use this function to sharpen or soften a copy image.

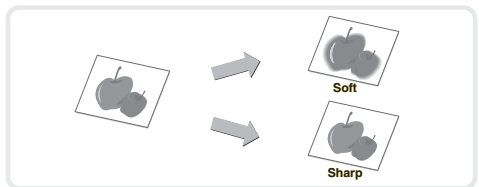

## Checking copies before printing (Proof Copy)

Regardless of the number of copies specified, this function initially prints only the first set. After you have checked the first set, the remaining sets are printed.

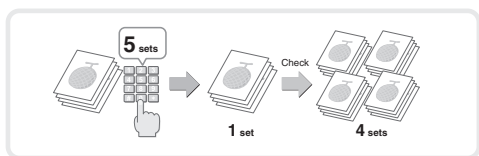

## Copying originals that are different sizes (Mixed Size Original)

For example, even when a 8-1/2" x 11" original is mixed in with 8-1/2" x 14" originals, this function lets you copy all originals at once.

When used in combination with the auto image function, the copies can all be printed on the same size of paper.

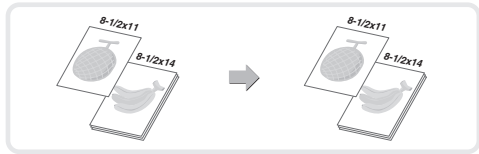

## Copying thin originals (Slow Scan Mode)

This function lets you scan thin originals, which are normally difficult to handle, in the automatic document feeder.

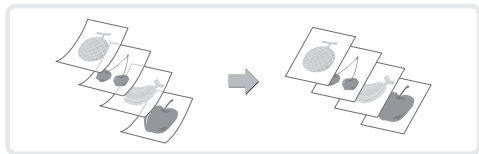

## Copying multiple business cards (Business Card Scan)

Up to eight business cards can be copied onto a single sheet of paper. This function can be used to create a list of business cards or file multiple business cards together as a group. (Business card feeder is required.)

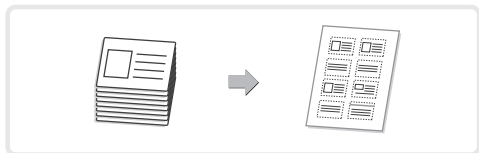

# Printing

This section explains the basic procedure for printing using the printer driver of the machine. The settings that can be selected in the printer driver are also introduced.

The explanations of screens and procedures are primarily for Windows Vista® in Windows® environments, and Mac OS X v10.4 in Macintosh environments. The window varies depending on the operating system version, the printer driver version, and the application.

▶ <b>PRINTING</b> .....	<b>58</b>
▶ <b>CANCELING PRINTING (AT THE MACHINE)</b> .....	<b>64</b>
▶ <b>SELECTING PRINT SETTINGS</b> .....	<b>65</b>
▶ <b>CONVENIENT PRINTER FUNCTIONS</b> .....	<b>67</b>

# PRINTING

This section explains the basic procedures for printing.

## Windows

The following example explains how to print a letter size document from WordPad, which is a standard accessory program in Windows. To install the printer driver and configure settings in a Windows environment, see "Chapter 2 - SETUP IN A WINDOWS ENVIRONMENT" in the Software Setup Guide.

For information on the available printer drivers and the requirements for their use, see "PRINTER FUNCTION OF THE MACHINE" in "Chapter 3 - PRINTER" in the Operation Guide.

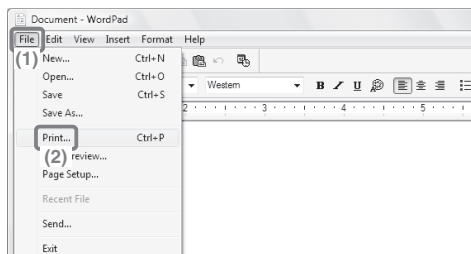

### 1 Select the print command in the application.

- (1) Open the [File] menu.
- (2) Select [Print].

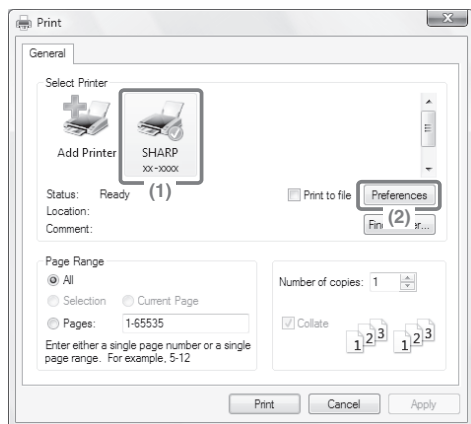

### 2 Open the printer driver properties window.

- (1) Select the printer driver of the machine.
- (2) Click the [Preferences] button.

In Windows 2000, the [Preferences] button does not appear. Click the tabs in the "Print" dialog box to adjust the settings on the tabs. In Windows 98/Me/NT 4.0, click the [Properties] button.

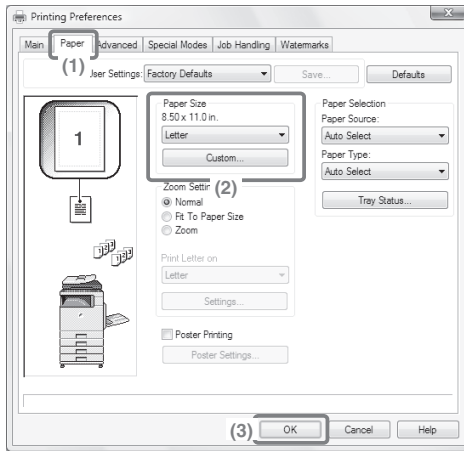

- 3 Select print settings.**
  - (1) Click the [Paper] tab.
  - (2) Select [Letter].
  - (3) Click the [OK] button.

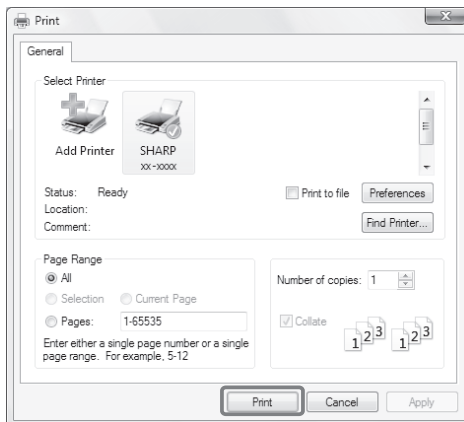

- 4 Click the [Print] button.**

Printing begins.  
In Windows 98/Me/NT 4.0, click the [OK] button.

# Using printer driver help

When selecting settings in the printer driver properties window, you can display Help to view explanations of the settings. (Only in Windows)

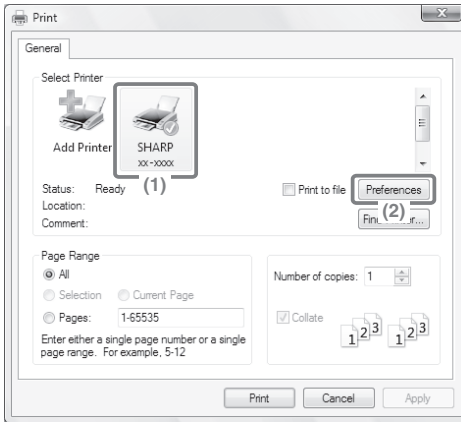

## 1 Open the printer driver properties window.

(1) Select the printer driver of the machine.

(2) Click the [Preferences] button.

In Windows 2000, the [Preferences] button does not appear. Click the tabs in the "Print" dialog box to adjust the settings on the tabs.

In Windows 98/Me/NT 4.0, click the [Properties] button.

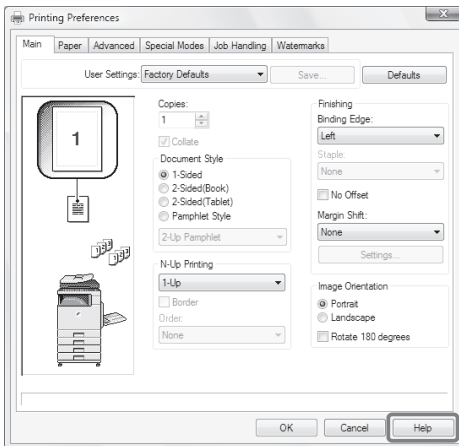

## 2 Click the [Help] button.

The Help window will open to let you view explanations of the settings on the tab.

To view Help for settings in a dialog box, click the green text at the top of the Help window.

**To view Help for a specific setting**

Click the setting that you wish to learn about and press the [F1] key. Help for that setting will appear.

\*To view Help for a particular setting in Windows 98/Me/NT 4.0/2000/XP/Server 2003, click the  button in the upper right-hand corner of the printer driver window and then click the setting.

**When the information icon () appears**

The icon can be clicked to show prohibited combinations of functions and other information.

# Macintosh

The following example explains how to print a letter size document from "TextEdit" ("SimpleText" in Mac OS 9), which is a standard accessory program on Macintosh computers.

To install the printer driver and configure settings in a Macintosh environment, see "Chapter 3 - SETUP IN A MACINTOSH ENVIRONMENT" in the Software Setup Guide.

## Setting the paper size

Select paper settings in the printer driver before selecting the print command.

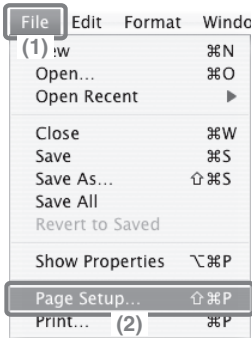

### 1 Open the page setup window in TextEdit.

(1) Open the [File] menu.

(2) Select [Page Setup].

In Mac OS 9, select [Print] from the [File] menu of SimpleText.

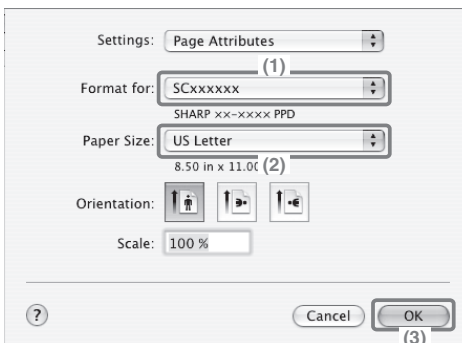

### 2 Select paper settings.

(1) Make sure the correct printer is selected.

The machine name that appears in the "Format for" menu is normally [SCxxxxxx]. ("xxxxxx" is a sequence of characters that varies depending on your machine model.)

(2) Select [US Letter].

(3) Click the [OK] button.



# Printing a file

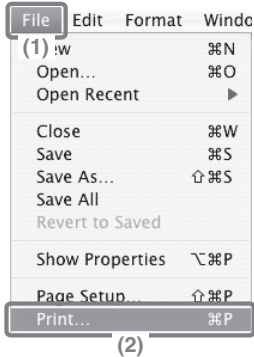

## 1 Execute printing from TextEdit.

- (1) Open the [File] menu.
- (2) Select [Print].

In Mac OS 9, select [Print] from the [File] menu of SimpleText.

## 2 Select print settings and click the [Print] button.

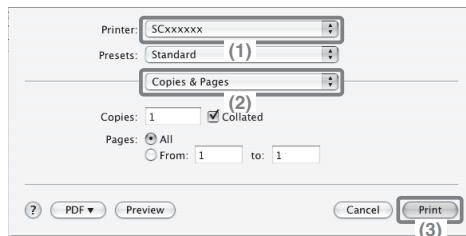

### (1) Make sure the correct printer is selected.

The machine name that appears in the "Printer" menu is normally [SCxxxxxx]. ("xxxxxx" is a sequence of characters that varies depending on your machine model.)

### (2) Select print settings.

Click [v] next to [Copies & Pages] and select each setting that you wish to configure from the pull-down menu. The screen for the selected setting will appear.

If the settings do not appear in Mac OS X v10.5 to 10.5.5, click [v] next to the printer name.

In Mac OS 9, click [v] next to [General] and select a setting from the pull-down menu. The screen for the selected setting will appear.

### (3) Click the [Print] button.

Printing begins.

# CANCELING PRINTING (AT THE MACHINE)

You can cancel a print job if you cancel before printing actually begins.

## JOB STATUS



**1 Press the [JOB STATUS] key.**

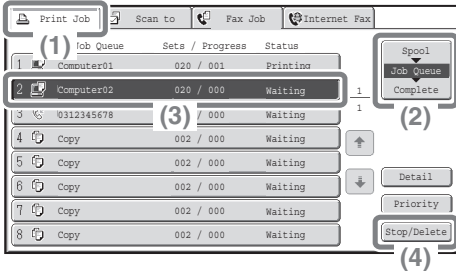

**2 Select settings in the touch panel.**

**(1) Touch the [Print Job] tab.**

**(2) Change the print job status mode to [Spool] or [Job Queue].**

Touch this key to change modes. The selected mode will be highlighted.

**(3) Touch the key of the print job that you wish to cancel.**

**(4) Touch the [Stop/Delete] key.**

**(5) Touch the [Yes] key.**

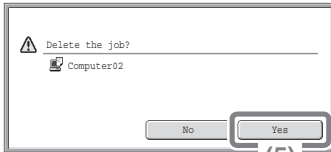

# SELECTING PRINT SETTINGS

To use the print function of the machine, the settings in the printer driver properties window must be configured. See "PRINTING" (page 58) for the procedure for opening the printer driver properties window and the basic procedure for printing.

## Windows

The procedure for selecting settings in the printer driver is explained below using "Fitting the print image to the paper (Fit To Paper Size)" as an example.

The Fit To Paper Size function is used to automatically enlarge or reduce the print image to fit the selected paper size. In this example, an Invoice-size image will be printed on letter-size paper.

The procedures for configuring printer driver settings vary by setting. **For more information on each setting, see "FREQUENTLY USED FUNCTIONS" and "CONVENIENT PRINTING FUNCTIONS" in "Chapter 3 - PRINTER" in the Operation Guide.**

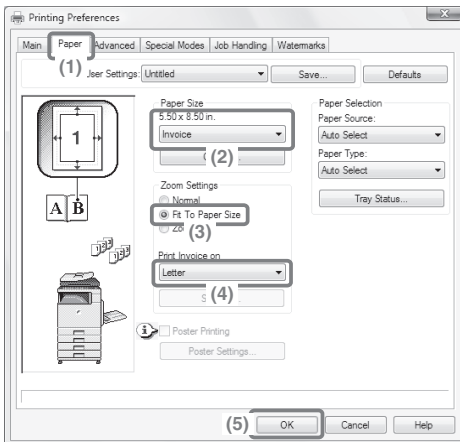

**Select print settings.**

**(1) Click the [Paper] tab.**

**(2) Select [Invoice].**

Select the size of the print image.

**(3) Select [Fit To Paper Size].**

**(4) Select [Letter].**

Select the size of paper that you want to print on.

**(5) Click the [OK] button.**

This completes the settings. Start printing.

# Macintosh

The procedure for selecting printer driver settings is explained below using "Printing multiple images on one page (N-Up Printing)" as an example. This function reduces the size of each page to let you print multiple pages on one sheet of paper. The example of printing two pages on one sheet of paper with borderlines is explained.

The procedures for configuring printer driver settings vary by setting. **For more information on each setting, see "FREQUENTLY USED FUNCTIONS" and "CONVENIENT PRINTING FUNCTIONS" in "Chapter 3 - PRINTER" in the Operation Guide.**

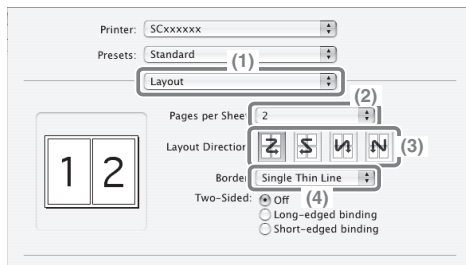

**Select print settings.**

**(1) Select [Layout].**

**(2) Select [2].**

**(3) Select the order of the pages.**

**(4) Select the desired type of borderline.**

# CONVENIENT PRINTER FUNCTIONS

## Printing on both sides of the paper (2-sided printing)

Use this function to print on both sides of the paper. You can use 2-sided printing to reduce the number of printed sheets when you are printing a large number of pages or when you wish to conserve paper.

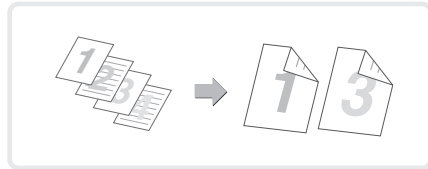

## Fitting the print image to the paper (Fit To Paper Size)

Use this function to enlarge or reduce the print image to fit the paper size. This is convenient for such purposes as enlarging an invoice or A5 size document to letter or A4 size paper to make it easier to view, and to print when the same size of paper as the print image is not loaded in the machine.

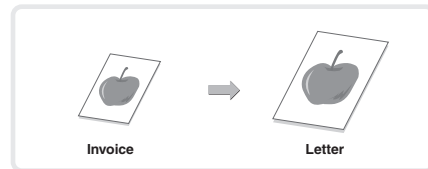

## Printing multiple images on one page (N-Up Printing)

Use this function to print multiple pages on a single sheet of paper by reducing the size of the print images. This is convenient when you wish to show an overall view of multiple pages or conserve paper.

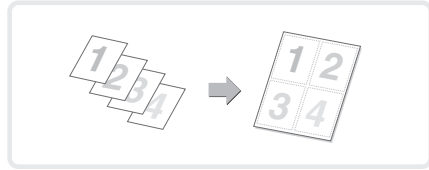

## Stapling printed pages (Staple)

Use this function to staple printed output. (When a finisher is installed.)

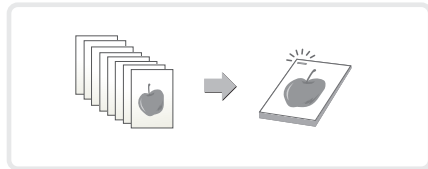

# The machine also has these functions

For information on each of these functions, see "CONVENIENT PRINTING FUNCTIONS" in "Chapter 3 - PRINTER" in the Operation Guide.

## Convenient functions for creating pamphlets and posters

- Creating a pamphlet (Pamphlet)
- Increasing margin (Margin Shift)
- Creating a large poster (Poster Printing)

## Functions to adjust the size and orientation of the image

- Rotating the image 180 degrees (Rotate 180 degrees)
- Enlarging/reducing the print image (Zoom / XY-Zoom)
- Adjusting line widths when printing (Line Width Settings)
- Reversing the image (Mirror Image)

## Image adjustment function

- Adjusting the brightness and contrast of the image (Image Adjustment)
- Printing faint text or lines in black (Text To Black/Vector To Black)

## Functions to combine text and images

- Adding a watermark to printed pages (Watermark)
- Printing an image over the print data (Image Stamp)
- Creating overlays for print data (Overlays)

## Print functions for special purposes

- Printing specified pages on different paper (Different Paper)
- Adding inserts when printing on transparency film (Transparency Inserts)
- Printing a carbon copy (Carbon Copy)
- Printing so that a specific page is the front page when using two-sided printing (Chapter Inserts)

## Convenient printer functions

- Saving and using print files (Retention/Document Filing)





# Faxing

This section explains the basic procedures for using the fax function of the machine. In addition, special modes that can be used with the fax function are introduced.

The facsimile expansion kit is required to use the fax function.

▶ <b>BASE SCREEN OF FAX MODE</b> .....	<b>72</b>
▶ <b>SENDING A FAX</b> .....	<b>74</b>
▶ <b>CHANGING THE SIZE OF A FAX</b> .....	<b>75</b>
▶ <b>CHANGING THE EXPOSURE</b> .....	<b>77</b>
▶ <b>CHANGING THE RESOLUTION</b> .....	<b>78</b>
▶ <b>STORING A FAX NUMBER</b> .....	<b>79</b>
▶ <b>FORWARDING RECEIVED FAXES (Fax Data Forward)</b> .....	<b>81</b>
▶ <b>CONVENIENT DIALING METHODS</b> .....	<b>83</b>
▶ <b>SENDING THE SAME FAX TO MULTIPLE DESTINATIONS (Broadcast Transmission)</b> .....	<b>87</b>
▶ <b>SPECIAL FAX MODES</b> .....	<b>89</b>
▶ <b>SELECTING A SPECIAL MODE</b> .....	<b>90</b>
▶ <b>CONVENIENT FAX FUNCTIONS</b> .....	<b>92</b>

# BASE SCREEN OF FAX MODE

Touch the [IMAGE SEND] key in the touch panel to open the base screen of fax mode. If the fax screen does not appear, touch the [Fax] tab. Select fax settings in the base screen.

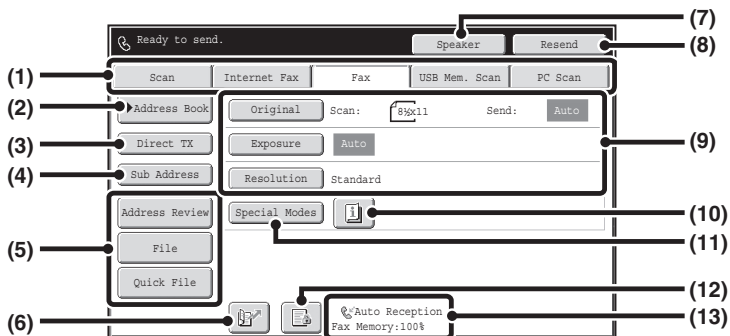

## (1) Send mode tabs

Use these tabs to change the mode of the image send function. To switch to fax mode, touch the [Fax] tab.

## (2) [Address Book] key

Touch this key to dial using a one-touch key or group key. When the key is touched, the address book screen appears.

## (3) [Direct TX] key

Touch this key to send a fax by direct transmission. When the [Direct TX] key is not highlighted, normal transmission (memory TX mode) is selected.

## (4) [Sub Address] key

Touch this key to enter a sub-address and passcode for F-code transmission.

## (5) Customized keys

The keys that appear here can be changed to show the settings or functions that you prefer.

## (6) key

Touch this key to retrieve a destination using a search number.\*

\* 3-digit number assigned to a destination when it is stored.

## (7) [Speaker] key / [Pause] key / [Space] key

Touch this key to dial using the speaker. When entering a fax number to be dialed, the key changes to the [Pause] key. When entering a sub-address, the key changes to the [Space] key.

**(8) [Resend] key / [Next Address] key**

The destinations of the most recent eight transmissions by Scan to E-mail, fax and/or Internet fax (including Direct SMTP addresses) are stored. To select one of these destinations, touch the desired destination. After a destination is selected, this key changes to the [Next Address] key.

**(9) Image settings**

Image settings (original size, exposure, resolution) can be selected.

**(10)  key**

This key appears when a special mode or 2-sided scanning is selected. Touch the key to display the selected special modes.

**(11) [Special Modes] key**

Touch this key to use a special mode.

**(12)  key /  key /  key**

When "Hold Setting for Received Data Print" or "Received Data Image Check Setting" is enabled in the system settings (administrator), this will appear when a fax is received.

 : Only "Hold Setting for Received Data Print" is enabled

 : Only "Received Data Image Check Setting" is enabled

 : Both settings are enabled

**(13) This shows the currently selected fax reception mode and the amount of free memory remaining.**

# SENDING A FAX

The basic procedure for sending faxes is explained below.  
In fax mode, color originals are sent as black and white images.

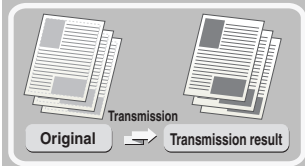

The side to be scanned must be face up!



## 1 Place the originals.

When using the document glass, place the original with the side to be scanned face down.

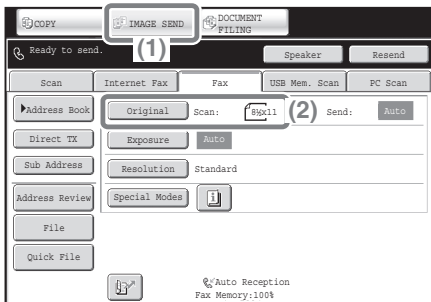

## 2 Select settings in the touch panel.

(1) Touch the [IMAGE SEND] key.

The base screen of fax mode appears.

If the fax screen does not appear, touch the [Fax] tab.

(2) Make sure that the size of the placed original is displayed.

If the wrong size appears, touch the key and select the correct size.

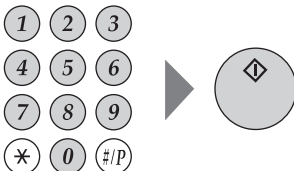

## 3 Enter the fax number of the receiving fax machine and press the [START] key.

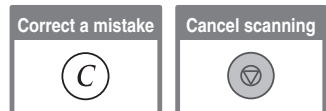

# CHANGING THE SIZE OF A FAX

The size of the original and the transmission size can be specified before transmission.

This is convenient when faxing an original that is small and difficult to read. The procedure for faxing both sides of an 8-1/2" x 11" original at 11" x 17" size is explained below.

The side to be scanned must be face up!



## 1 Place the originals.

When using the document glass, place the original with the side to be scanned face down.

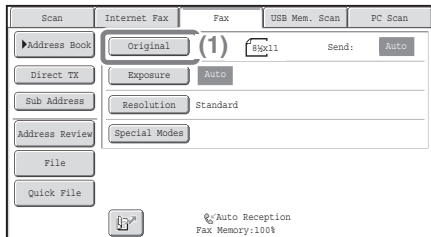

## 2 Select settings in the touch panel.

(1) Touch the [Original] key.

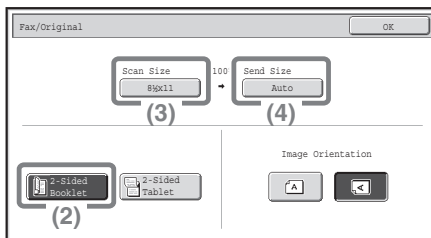

(2) Touch the [2-Sided Booklet] key.

This key is used to send a 2-sided original.

(3) Make sure that the size of the placed original is displayed.

If the wrong size appears, touch the key and select the correct size.

(4) Touch the [Send Size] key.

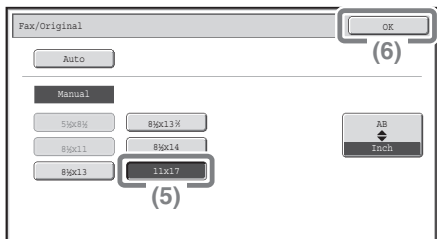

Select settings in the touch panel. (Continued)

(5) Touch the [11 x 17] key.

(6) Touch the [OK] key.

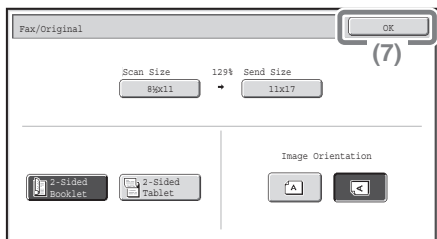

(7) Touch the [OK] key.

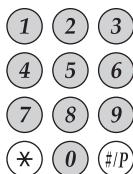

**3** Enter the fax number of the first destination.



**4** Press the [START] key.

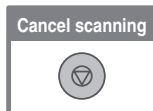

# CHANGING THE EXPOSURE

The exposure can be changed as appropriate for the darkness or lightness of the original.

The following example explains how to darken light colors in an original to make the image clearer.

The side to be scanned must be face up!



## 1 Place the originals.

When using the document glass, place the original with the side to be scanned face down.

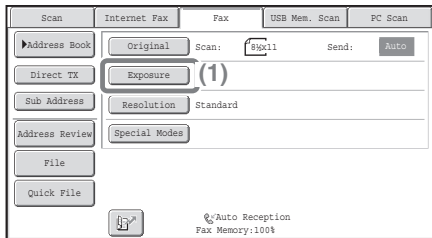

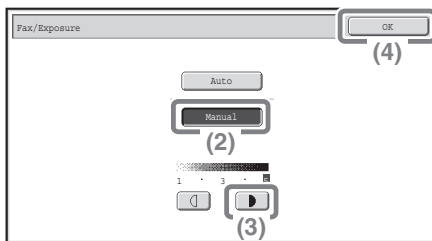

## 2 Select settings in the touch panel.

(1) Touch the [Exposure] key.



(2) Touch the [Manual] key.

(3) Touch the  key to darken the exposure.

5 levels are available for the exposure. Darken light originals with the  key, and lighten dark originals with the  key.

(4) Touch the [OK] key.

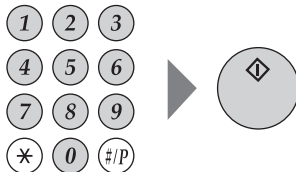

## 3 Enter the fax number of the receiving fax machine and press the [START] key.



# CHANGING THE RESOLUTION

The resolution can be selected to match the characteristics of the original, such as text or photo, the size of the text, and the darkness of the image. The following example explains how to set the resolution to [Fine] and [Half Tone] when sending an original with small text.

The side to be scanned must be face up!



## 1 Place the originals.

When using the document glass, place the original with the side to be scanned face down.

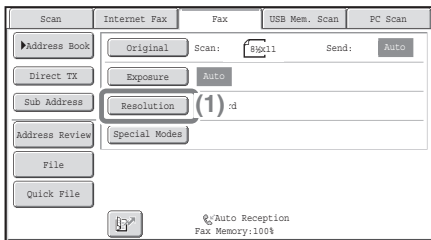

## 2 Select settings in the touch panel.

(1) Touch the [Resolution] key.

(2) Touch the [Fine] key.

The resolution increases (producing a clearer image) in the following order: [Standard], [Fine], [Super Fine], [Ultra Fine].

(3) Touch the [Half Tone] key.

Select [Half Tone] for a photo or illustration with shading to further improve the image.

[Half Tone] cannot be selected when [Standard] is selected.

(4) Touch the [OK] key.

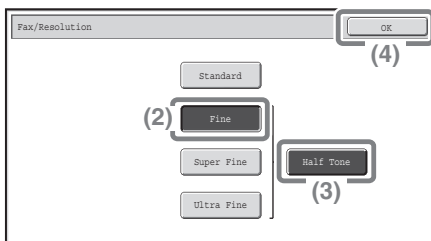

## 3 Enter the fax number of the receiving fax machine and press the [START] key.

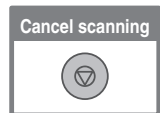
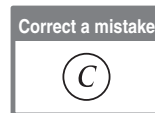
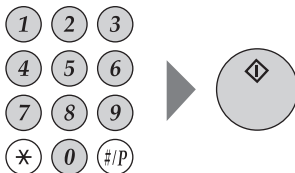



# STORING A FAX NUMBER

You can store fax numbers in one-touch keys.  
Stored fax numbers can be retrieved quickly and easily.  
If you frequently send faxes to the same group of fax machines, the numbers of those fax machines can be stored as a group (multiple fax numbers can be stored in one key).

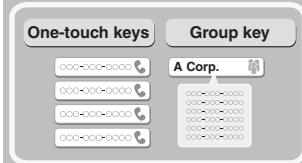

## Storing an individual key

SYSTEM  
SETTINGS



**1** Press the [SYSTEM SETTINGS] key.

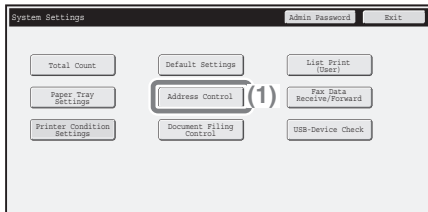

**2** Select settings in the touch panel.  
(1) Touch the [Address Control] key.

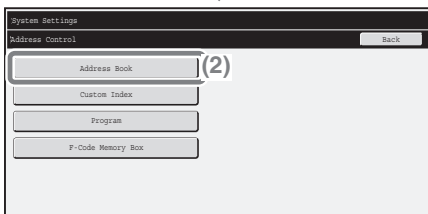

(2) Touch the [Address Book] key.

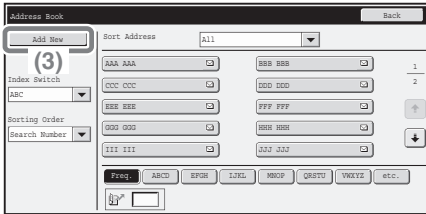

Select settings in the touch panel. (Continued)  
**(3) Touch the [Add New] key.**

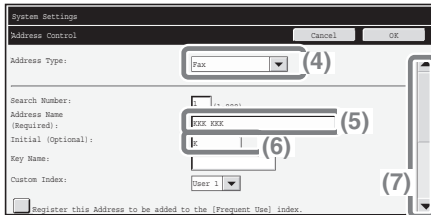

**(4) Select [Fax] from the "Address Type" select box.**

**(5) Touch the "Address Name" text box.**

A text entry screen appears. Enter the name of the destination.

**(6) Touch the "Initial" text box.**

A text entry screen appears. Enter search characters for the destination.

**(7) Slide the scroll bar down to move the screen.**

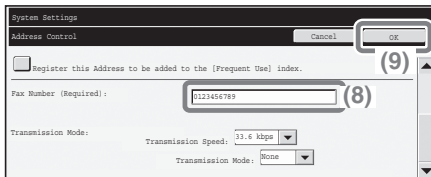

**(8) Touch the "Fax Number" text box.**

A text entry screen appears. Enter the fax number that you wish to store.

**(9) Touch the [OK] key.**

The items in the above step must be entered. For details on items entered, see "Chapter 7 - SYSTEM SETTINGS" in the Operation Guide.

When sending the same document or image to multiple destinations, it is convenient to store a destination group. For details on storing groups, see "Chapter 7 - SYSTEM SETTINGS" in the Operation Guide.

# FORWARDING RECEIVED FAXES (Fax Data Forward)

When the machine cannot print because it is out of paper or out of toner, received faxes can be forwarded to another fax machine.

To use this function, the fax number of the destination machine must be stored in "Set the Telephone Number for Data Forwarding" in the system settings (administrator).

SYSTEM  
SETTINGS



**1 Press the [SYSTEM SETTINGS] key.**

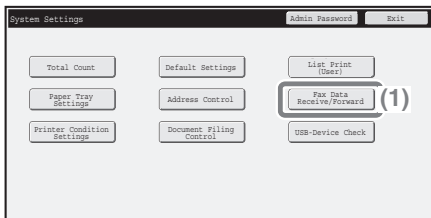

**2 Select settings in the touch panel.**

**(1) Touch the [Fax Data Receive/Forward] key.**



**(2) Touch the [Fax Settings] key.**



Select settings in the touch panel. (Continued)  
**(3) Touch the [Execute] key in "Forward Received Data".**

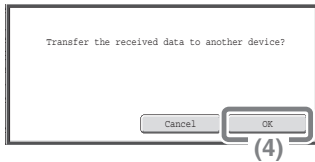

**(4) Touch the [OK] key.**

# CONVENIENT DIALING METHODS

Easy to use one-touch keys and the resend function can be used to prevent dialing errors and save time.

## One-touch keys

A fax number stored in a one-touch key can be retrieved by a simple touch of the key.

A one-touch key for a group can be selected to automatically transmit to each of the destinations stored in the group.

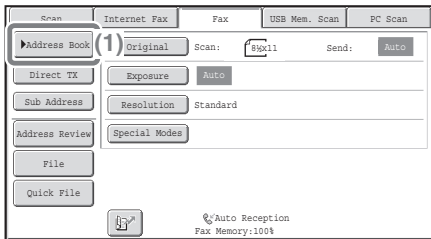

**(1) Touch the [Address Book] key.**

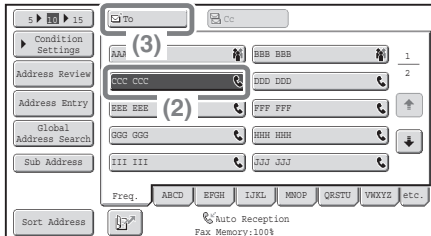

**(2) Touch the key of the desired destination.**

To change the number of one-touch keys displayed in the screen, touch the  key. Select 5, 10, or 15 keys.

**(3) Touch the [To] key.**

# Resending

The [Resend] key can be touched to transmit to one of the eight most recent destinations used for transmission.

Resending is not possible in some cases, such as when an image is sent using a one-touch key for a group.

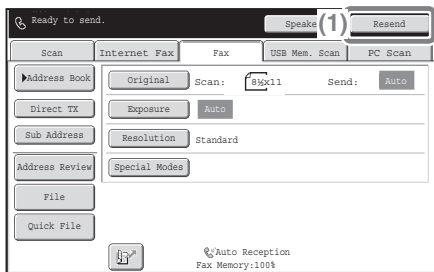

**(1) Touch the [Resend] key.**

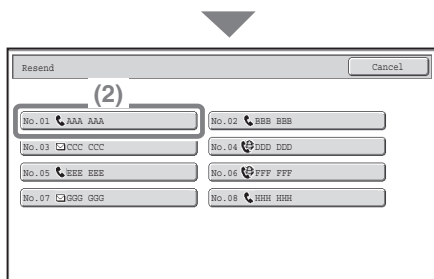

**(2) Touch the key of the desired destination.**

The destinations that appear also include Scan to E-mail and Internet fax destinations.

# Speed dialing

When you store an individual key or a group key, a 3-digit search number is assigned to the key.

You can select a destination using the  key and the 3-digit search number.

To check a search number, print the appropriate list in the sending address list menu in the system settings.

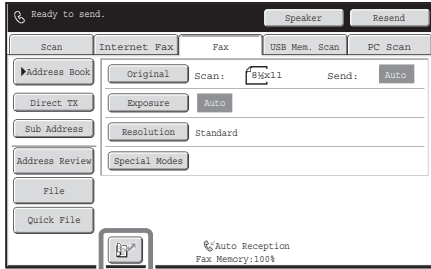

(1) Touch the  key.

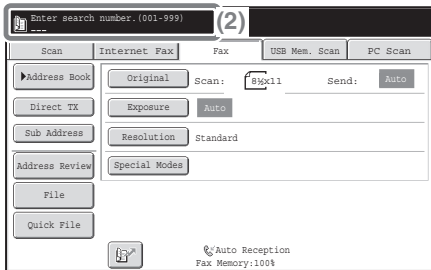

(2) Enter the 3-digit search number with the numeric keys.

## Dialing using the speaker

When the speaker is used to dial, fax transmission is started after the number is dialed and the connection is established. If a person answers, you will be able to hear his or her voice, but you will not be able to speak.

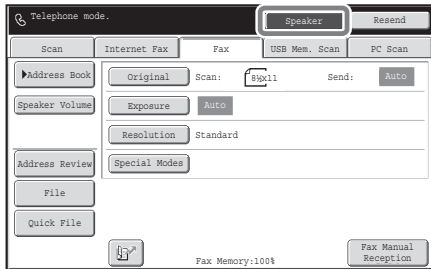

### Touch the [Speaker] key.

You will hear the dial tone through the machine's speaker.

Dial the fax number of the destination with the numeric keys or with the [Address Book] key.

When the connection is established, press the [START] key to send the fax.



# SENDING THE SAME FAX TO MULTIPLE DESTINATIONS (Broadcast Transmission)

The same document/image can be sent to multiple fax mode, scan mode, and Internet fax mode destinations in a single operation. If you frequently send documents/images to the same group of destinations, it is recommended that you store those destinations as a group in a one-touch key. The following procedure explains how to enter a fax number with the numeric keys and then select a destination that is stored in a one-touch key.

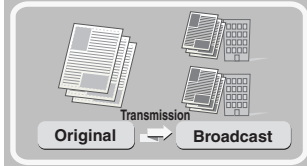

The side to be scanned must be face up!



## 1 Place the originals.

When using the document glass, place the original with the side to be scanned face down.

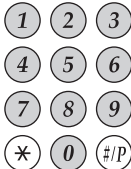

## 2 Enter the fax number of the first destination.

Correct a mistake



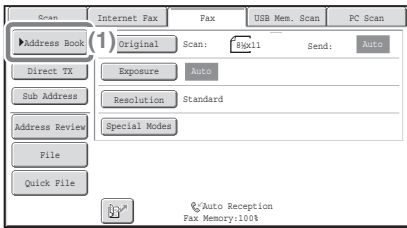

### 3 Select settings in the touch panel.

(1) Touch the [Address Book] key.

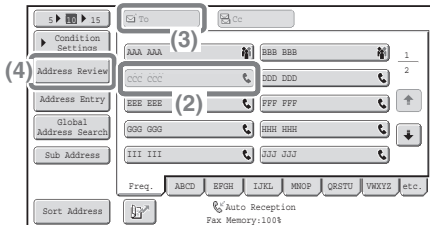

(2) Touch the one-touch key in which the desired destination is stored.

To change the number of one-touch keys displayed in the screen, touch the  key. Select 5, 10, or 15 keys.

(3) Touch the [To] key.

(4) Touch the [Address Review] key.

(5) Check the destinations and then touch the [OK] key.

To delete a destination, touch the key of the destination that you wish to delete. A message will appear to confirm the deletion. Touch the [Yes] key.

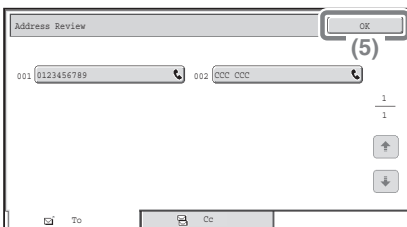

### 4 Press the [START] key.

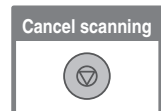

# SPECIAL FAX MODES

The special modes can be used for a variety of special-purpose fax transmission jobs.

The following pages show the types of fax transmissions that can be performed. (The procedures for using each special mode are not explained.) Each special mode has its own settings and steps, however, the basic procedure is the same for all modes. The basic procedure for selecting a special mode is explained on the next page using "Erase" as an example.

**For the procedures for using the special modes, see "SPECIAL MODES" in "Chapter 4 - FACSIMILE" in the Operation Guide.**

## Special modes

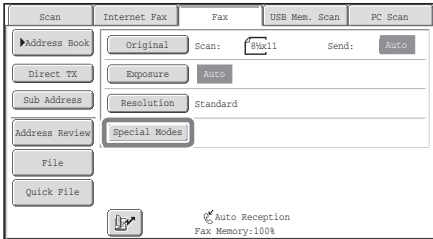

To use a special mode, open the special modes menu and touch the key of mode that you wish to use. The menu consists of two screens. Use the  $\downarrow$   $\uparrow$  keys to switch between the screens.

Touch the [Special Modes] key in the base screen to open the special modes menu.

### 1st screen

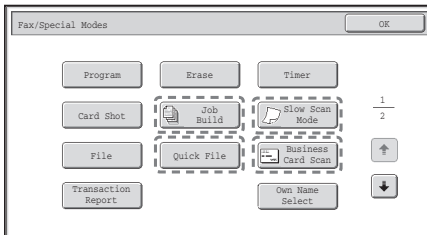

### 2nd screen

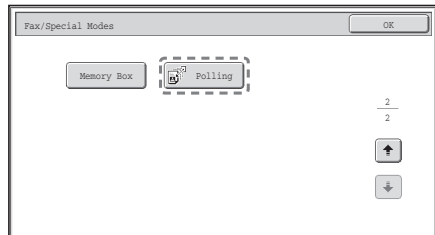

When a special mode key encircled by  $\square$  is touched, the key is highlighted and the setting is completed.

When any other special mode key is touched, a screen appears to let you select settings for that mode.

The keys that appear will vary depending on what peripheral devices are installed.

# SELECTING A SPECIAL MODE

The procedure for selecting a special mode for fax is explained below. The settings that must be selected vary for each special mode, however, the general procedure is the same. The procedure for erasing shadows at the edges of the image when sending a fax is explained below as an example.

The side to be scanned must be face up!



## 1 Place the originals.

When using the document glass, place the original with the side to be scanned face down.

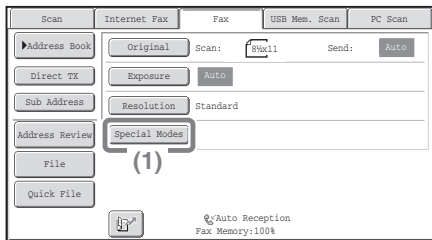

## 2 Select settings in the touch panel.

(1) Touch the [Special Modes] key.

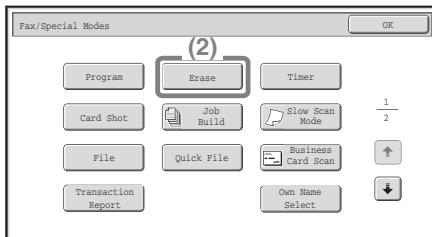

(2) Touch the [Erase] key.

The erase settings will be configured to erase a width of 3/4" around the edges of the original.

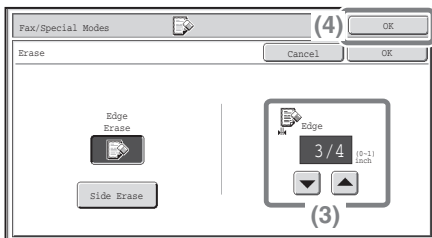

(3) Set the erasure width to 3/4" with the   keys.

The erase area is set to "Edge Erase" by default.

A particular side can be erased by touching the [Side Erase] key and selecting settings for that side.

(4) Touch the [OK] key.

**3** Enter the fax number of the receiving fax machine and press the [START] key.

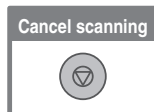
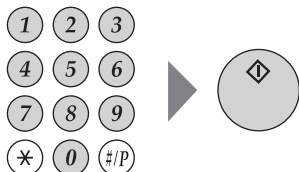

# CONVENIENT FAX FUNCTIONS

## Erasing peripheral shadows (Erase)

Use this function to erase peripheral shadows that occur when faxing books and other thick originals.

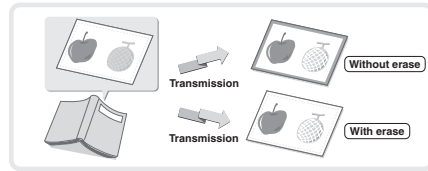

## Sending the front and reverse sides of a card as a single page (Card Shot)

Use this function to send the front and reverse sides of a card as a single page in a single transmission.

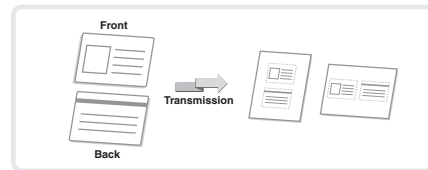

## Sending a large number of pages as a single transmission job (Job Build)

A stack of originals higher than the indicator line on the automatic document feeder cannot be fed through the feeder.

The job build function lets you divide the stack of originals into sets, feed each set, and send the sets as a single transmission.

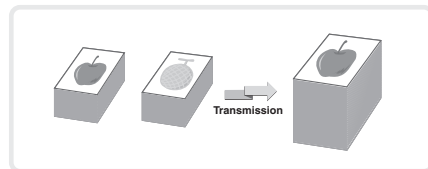

## Sending a fax directly from a computer (PC-Fax)

A document on a computer can be sent via the machine as a fax. Select the PC-Fax driver as the printer driver on your computer and then select the Print command in the software application. Image data for transmission will be created and sent as a fax.

This function can only be used on a Windows computer.

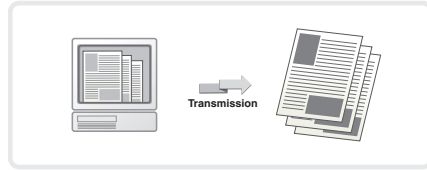

For more information, see the Help file for the PC-Fax driver.

## The machine also has these functions

- Forwarding a received fax to a network address (Inbound Routing Settings)
  - ☞ Operation Guide "FAX RECEPTION" in "Chapter 4 - FACSIMILE"
- Sending a fax at a specified time (Timer)
- Storing fax operations (Program)
- Changing the print settings for the transaction report (Transaction Report)
- Temporarily changing the sender information (Own Name Select)
- Faxing thin originals (Slow Scan Mode)
- Sending business cards (Business Card Scan) (Business card feeder is required.)
- Calling a fax machine and initiating fax reception (Polling)
- Sending a fax when another machine polls your machine (Polling Memory)
  - ☞ Operation Guide "SPECIAL MODES" in "Chapter 4 - FACSIMILE"
- Performing F-code communication
  - ☞ Operation Guide "PERFORMING F-CODE COMMUNICATION" in "Chapter 4 - FACSIMILE"
- Connecting and using an existing phone (Extension Phone Connection)
  - ☞ Operation Guide "USING AN EXTENSION PHONE" in "Chapter 4 - FACSIMILE"





# Scanning

This section explains the uses of the network scanner function and the basic procedure for using scan mode. In addition, special modes that can be used with the network scanner function are introduced.

The Internet fax expansion kit is required to use the Internet fax function.

▶ NETWORK SCANNER FUNCTION .....	96
▶ BASE SCREEN OF SCAN MODE .....	97
▶ SCANNING AN ORIGINAL .....	98
▶ CHANGING THE EXPOSURE AND ORIGINAL IMAGE TYPE .....	100
▶ CHANGING THE RESOLUTION .....	102
▶ CHANGING THE FILE FORMAT .....	103
▶ STORING A DESTINATION .....	105
▶ CONVENIENT TRANSMISSION METHODS .....	107
▶ SENDING THE SAME IMAGE TO MULTIPLE DESTINATIONS (Broadcast Transmission) .....	110
▶ SPECIAL SCAN MODES .....	112
▶ SELECTING A SPECIAL MODE .....	113
▶ CONVENIENT SCANNER FUNCTIONS .....	115

# NETWORK SCANNER FUNCTION

The network scanner function of the machine can be used to transmit scanned images by a variety of methods. The network scanner function has the following modes.

## Scan modes



To send an image to an e-mail address, use

### Scan to E-mail



To upload an image to an FTP server, use

### Scan to FTP



To send an image to a shared folder on your computer, use

### Scan to Network Folder

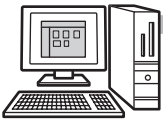

To process an image in a specific application, use

### Scan to Desktop

Scan the original,  
and then...



## USB memory mode

Use this mode to save an image to USB memory



## Internet fax mode

Use this mode to send a fax via the Internet



The machine supports Direct SMTP.

## PC scan mode

Use this mode to scan a photo while making corrections on your computer



A TWAIN-compliant software application can be used.

## Data entry mode

Use this mode for an application-linked document solution



- Modes that can be used will vary depending on your model and the expansion kits that are installed.
- The explanations in this manual are centered on the Scan to E-mail function of scan mode.

➤ Operation Guide "Chapter 5 - SCANNER / INTERNET FAX"

# BASE SCREEN OF SCAN MODE

Touch the [IMAGE SEND] key in the touch panel to open the base screen of scan mode. If the scan screen does not appear, touch the [Scan] tab. Select various scan settings in the base screen.

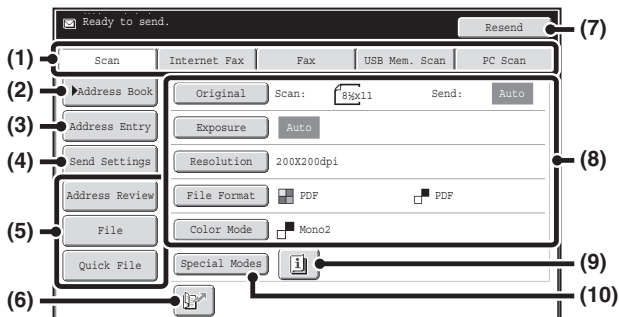

## (1) Send mode tabs

Use these keys to change the mode of the image send function. To switch to scan mode, touch the [Scan] tab.

## (2) [Address Book] key

Touch this key to use a one-touch key or a group key. When the key is touched, the address book screen appears.

## (3) [Address Entry] key

Touch this key to manually enter a destination address instead of using a one-touch key.

## (4) [Send Settings] key

Touch this key to select or enter the subject, file name, sender name, or message text, which have been previously stored in the Web page.

## (5) Customized keys

The keys that appear here can be changed to show the settings or functions that you prefer.

## (6) key

Touch this key to specify a destination using a search number\*.  
\* 3-digit number assigned to a destination when it is stored.

## (7) [Resend] key / [Next Address] key

The destinations of the most recent eight transmissions by Scan to E-mail, fax and/or Internet fax (including Direct SMTP addresses) are stored. To select one of these destinations, touch the desired destination. After a destination is selected, this key changes to the [Next Address] key.

## (8) Image settings

Image settings (original size, exposure, resolution, file format, and color mode) can be selected.

## (9) key

This key appears when a special mode or 2-sided scanning is selected. Touch the key to display the selected special modes.

## (10) [Special Modes] key

Touch this key to use a special mode.

# SCANNING AN ORIGINAL

The basic operation for scanning is explained below.  
This section explains how to send a scanned file by e-mail.  
In scan mode, originals can be scanned in full color or grayscale.

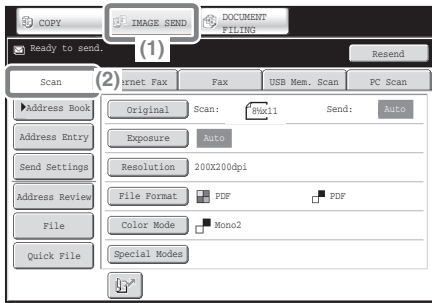
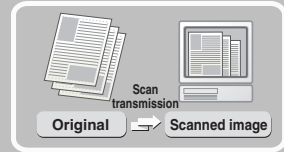

## 1 Select settings in the touch panel.

(1) Touch the [IMAGE SEND] key.

(2) Touch the [Scan] tab.  
The base screen of scan mode appears.

The side to be scanned must be face up!



## 2 Place the originals.

When using the document glass, place the original with the side to be scanned face down.

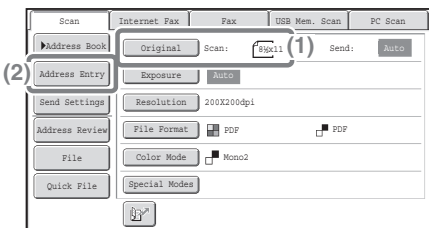

## 3 Select settings in the touch panel.

(1) Make sure that the size of the placed original is displayed.

If the wrong size appears, touch the key and select the correct size.

(2) Touch the [Address Entry] key.

(3) Touch the [To] key.

A text entry screen will appear. Enter the e-mail address of the recipient and touch the [OK] key.

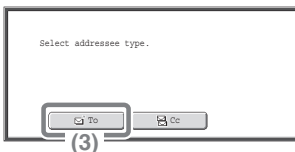



**4 Press the [START] key.**

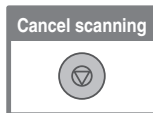

# CHANGING THE EXPOSURE AND ORIGINAL IMAGE TYPE

Exposure and original image type settings can be selected as appropriate for the original.

The procedure for darkening the exposure and setting the original image type to "Text/Prt'd. Photo" is explained below.

The side to be scanned must be face up!



## 1 Place the originals.

When using the document glass, place the original with the side to be scanned face down.

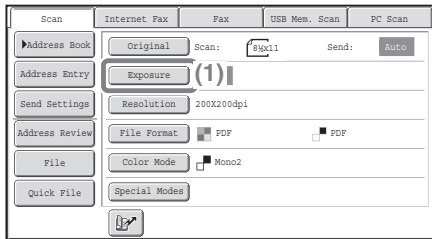

## 2 Select settings in the touch panel.

(1) Touch the [Exposure] key.

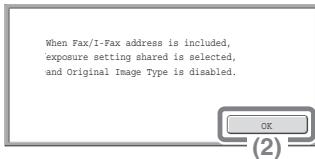

(2) Read the displayed message and touch the [OK] key.

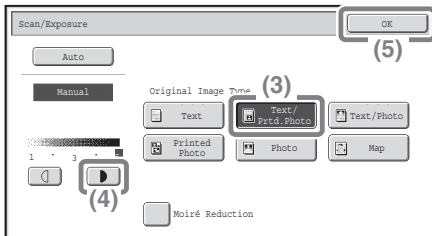

(3) Touch the [Text/Prt'd. Photo] key.

(4) Darken light colors with the [Darken] key.

5 levels are available for the exposure. Darken light originals with the [Darken] key, and lighten dark originals with the [Lighten] key.

(5) Touch the [OK] key.



**3** Select the destination and then press the [START] key.

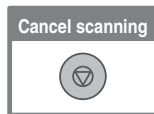

# CHANGING THE RESOLUTION

You can select the resolution as appropriate for the original type. This section explains how to set the resolution to "300X300dpi", which creates a clearer image than the default resolution.

The side to be scanned must be face up!



## 1 Place the originals.

When using the document glass, place the original with the side to be scanned face down.

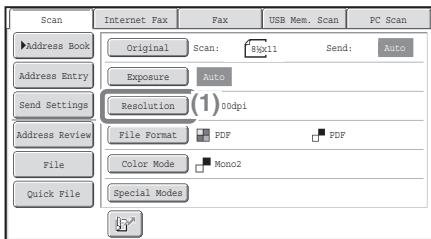

## 2 Select settings in the touch panel.

(1) Touch the [Resolution] key.

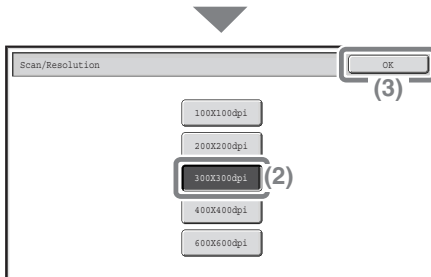

(2) Touch the [300X300dpi] key.

(3) Touch the [OK] key.



## 3 Select the destination and then press the [START] key.

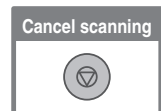



# CHANGING THE FILE FORMAT

The file format (file type and compression method) for sending a scanned image is specified when the destination is stored in a one-touch key; however, you can change the format at the time of transmission. The procedure for sending a scanned image in full color TIFF format is explained below.

The side to be scanned must be face up!



## 1 Place the originals.

When using the document glass, place the original with the side to be scanned face down.

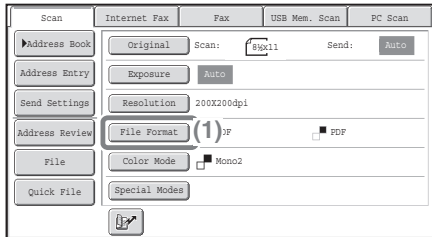

## 2 Select settings in the touch panel.

(1) Touch the [File Format] key.



(2) Read the displayed message and touch the [OK] key.

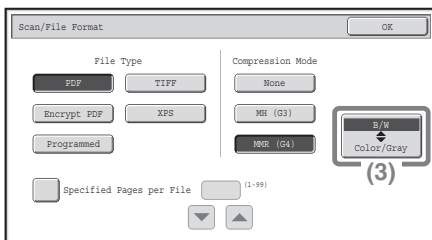

(3) Change the mode to Color/Grayscale mode.

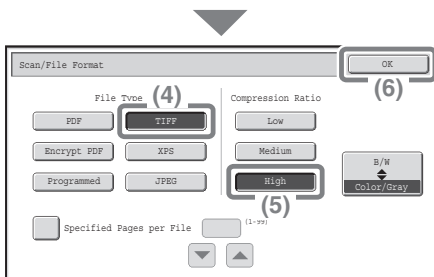

Select settings in the touch panel. (Continued)

(4) Touch the [TIFF] key.

(5) Touch the [High] key.

This sets the compression to high. A higher compression ratio creates a smaller file size.

(6) Touch the [OK] key.



**3** Select the destination and press the [START] key.

If the file type is set to [Encrypt PDF], you will be prompted to enter a password when you start transmission.

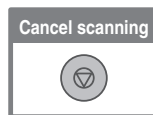

# STORING A DESTINATION

The procedure for storing e-mail addresses in one-touch keys for Scan to E-mail is explained below.

Stored e-mail addresses can be retrieved quickly and easily.

If you frequently send images to the same group of destinations, those destinations can be stored as a group.

To store destinations for the other modes of the network scanner function, see "STORING DESTINATION ADDRESSES FOR EACH SCAN MODE IN THE ADDRESS BOOK" in "Chapter 5 - SCANNER / INTERNET FAX" in the Operation Guide.

## Storing an individual key

SYSTEM  
SETTINGS



**1** Press the [SYSTEM SETTINGS] key.

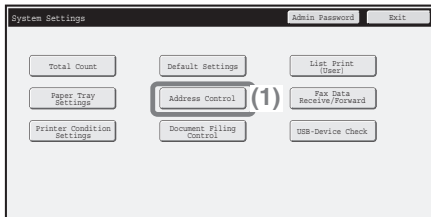

**2** Select settings in the touch panel.

(1) Touch the [Address Control] key.

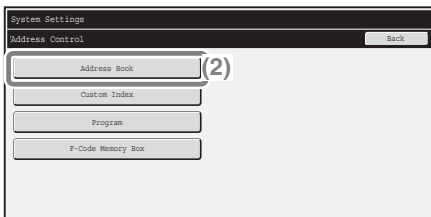

(2) Touch the [Address Book] key.

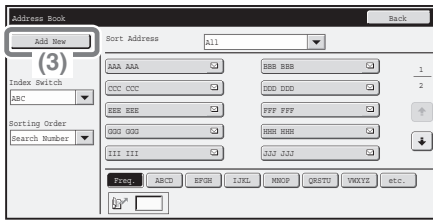

Select settings in the touch panel. (Continued)  
**(3) Touch the [Add New] key.**

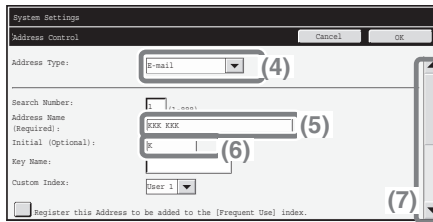

**(4) Select [E-mail] from the "Address Type" select box.**  
**(5) Touch the "Address Name" text box.**

A text entry screen appears. Enter the name of the destination.

**(6) Touch the "Initial" text box.**

A text entry screen appears. Enter search characters for the destination.

**(7) Slide the scroll bar down to move the screen.**

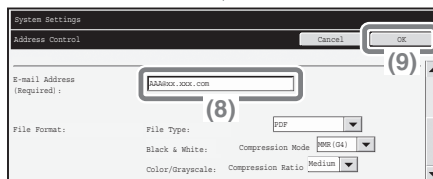

**(8) Touch the "E-mail Address" text box.**

A text entry screen appears. Enter the E-mail address that you want to store.

**(9) Touch the [OK] key.**

The items in the above step must be entered. For details on items entered, see "Chapter 7 - SYSTEM SETTINGS" in the Operation Guide.

When sending the same document or image to multiple destinations, it is convenient to store a destination group. For details on storing groups, see "Chapter 7 - SYSTEM SETTINGS" in the Operation Guide.

# CONVENIENT TRANSMISSION METHODS

One-touch sending, resending, and other convenient transmission functions that make it easy to send an image are available.

## One-touch key

A destination stored in a one-touch key can be retrieved by a simple touch of the key.

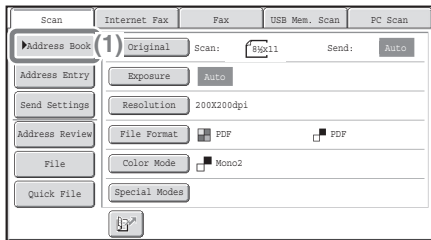

**(1) Touch the [Address Book] key.**

**(2) Touch the key in which the desired destination is stored.**

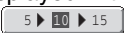
To change the number of one-touch keys displayed in the screen, touch the  key. Select 5, 10, or 15 keys.

**(3) Touch the [To] key.**

If an e-mail address is stored in the one-touch key, select [To] or [Cc] to specify the type of recipient after selecting the key.

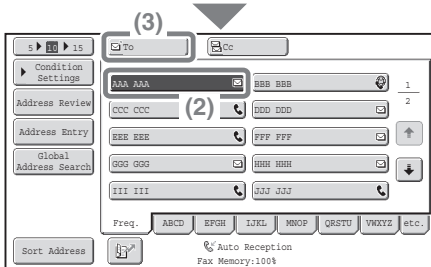

# Resending

The [Resend] key can be touched to send an image to one of the most recent 8 transmission destinations.

Resending is not possible in some cases, such as when an image is sent using a one-touch key for a group.

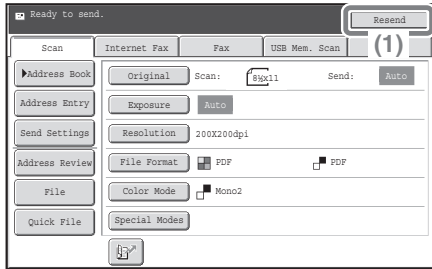

**(1) Touch the [Resend] key.**

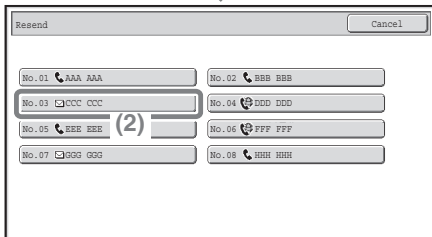

**(2) Touch the key in which the desired destination is stored.**

The destinations that appear also include fax and Internet fax destinations.

# Search number sending

When you store an individual key or a group key, a 3-digit search number is assigned to the key.

You can select a destination using the  key and the 3-digit search number.

To check a search number, print the appropriate list in the sending address list menu in the system settings.

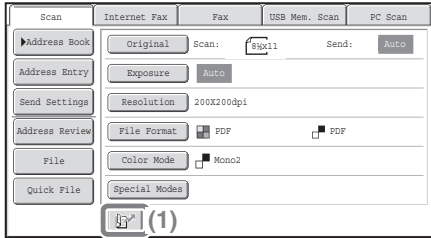

(1) Touch the  key.

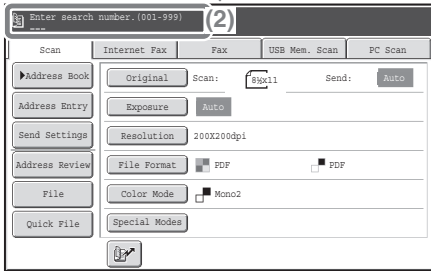

(2) Enter the 3-digit search number with the numeric keys.

# SENDING THE SAME IMAGE TO MULTIPLE DESTINATIONS (Broadcast Transmission)

The same image can be sent to multiple scan mode, Internet fax mode, and fax mode destinations in a single operation. If you frequently send images to the same group of destinations, it is recommended that you store those destinations as a group in a one-touch key.

The procedure for selecting multiple destinations stored in one-touch keys and sending an image to those destinations is explained below.

The side to be scanned must be face up!



## 1 Place the originals.

When using the document glass, place the original with the side to be scanned face down.

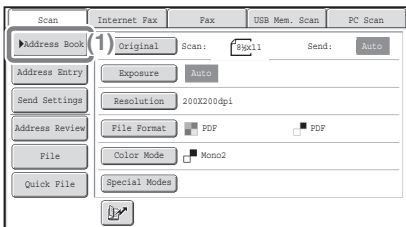

## 2 Select settings in the touch panel.

(1) Touch the [Address Book] key.

(2) Touch the one-touch key in which the desired destination is stored.

To change the number of one-touch keys displayed in the screen, touch the **5 ▶ 10 ▶ 15** key. Select 5, 10, or 15 keys.

(3) Touch the one-touch keys of the additional destinations to which you want to send the image.

(4) Touch the [To] key.

(5) Touch the [Address Review] key.

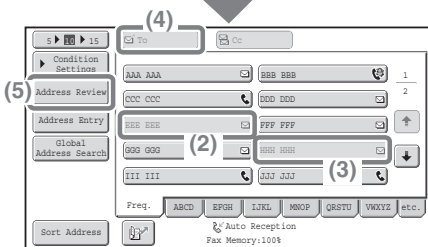



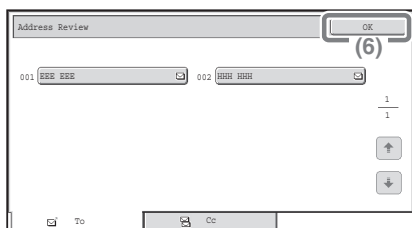

## Select settings in the touch panel. (Continued)

### (6) Check the destinations and then touch the [OK] key.

To delete a destination, touch the key of the destination that you wish to delete. A message will appear to confirm the deletion. Touch the [Yes] key.



### 3 Press the [START] key.

If fax or Internet fax destinations are included in the broadcast transmission, scanning will take place in [Mono2].

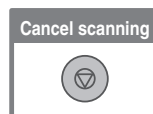

# SPECIAL SCAN MODES

The special modes can be used for a variety of special-purpose scan send jobs.

The following pages show the types of scan send jobs that can be performed. (The procedures for using each special mode are not explained.) Each special mode has its own settings and steps, however, the basic procedure is the same for all modes. The basic procedure for selecting a special mode is explained on the next page using "Suppress Background" as an example.

**For the procedures for using the special modes, see "SPECIAL MODES" in "Chapter 5 - SCANNER / INTERNET FAX" in the Operation Guide.**

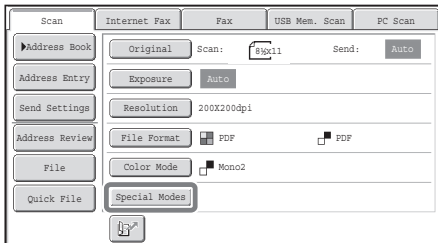

To use a special mode, open the special modes menu and touch the key of mode that you wish to use. The menu varies depending on whether scan mode, Internet fax mode, or USB memory mode is selected.

Touch the [Special Modes] key in the base screen to open the special modes menu.

## Scan mode

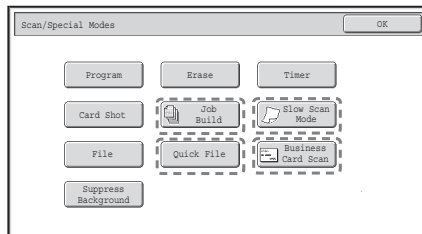

When a special mode key encircled by  is touched, the key is highlighted and the setting is completed.

When any other special mode key is touched, a screen appears to let you select settings for that mode.

The keys that appear will vary depending on what peripheral devices are installed.

# SELECTING A SPECIAL MODE

The procedure for selecting a special mode for the scanner function is explained below.

The settings that must be selected vary for each special mode, however, the general procedure is the same. The procedure for selecting "Whitening faint colors in the image (Suppress Background)" is explained here as an example.

The side to be scanned must be face up!



## 1 Place the originals.

When using the document glass, place the original with the side to be scanned face down.

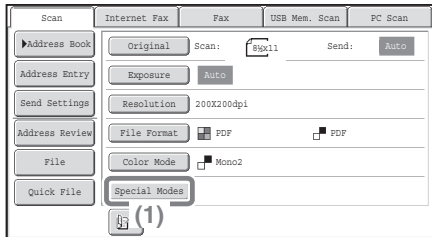

## 2 Select settings in the touch panel.

(1) Touch the [Special Modes] key.

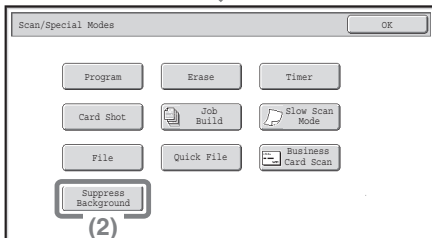

(2) Touch the [Suppress Background] key.

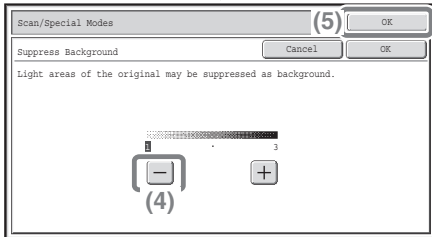
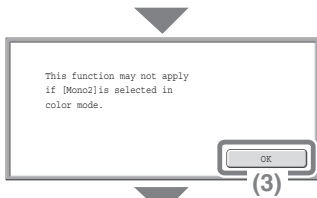

**Select settings in the touch panel. (Continued)**

**(3) Read the displayed message and touch the [OK] key.**

**(4) Set the darkness of the background that will remain with the [-] [+] keys.** 3 levels are available. Touch the [-] key for a lighter background. Touch the [+] key for a darker background. Here "1" is set for the lightest background.

**(5) Touch the [OK] key.**



**3 Select the destination and press the [START] key.**

This function cannot be used when the original is scanned in [Mono2].

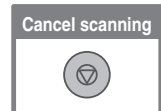

# CONVENIENT SCANNER FUNCTIONS

## Erasing peripheral shadows on the image (Erase)

Use this function to erase peripheral shadows that occur when scanning books and other thick originals.

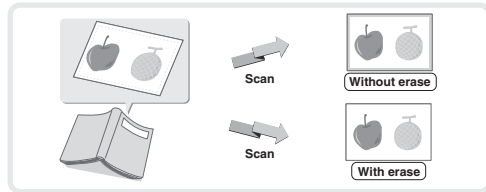

## Whitening faint colors in the image (Suppress Background)

Use this function to suppress light background areas in the scanned image. This is convenient for scanning an original that is printed on colored paper. This function does not operate in black and white mode.

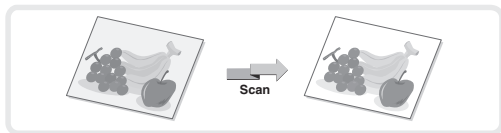

## Scanning both sides of a card onto a single page (Card Shot)

Use this function to scan the front and back of a card as a single image.

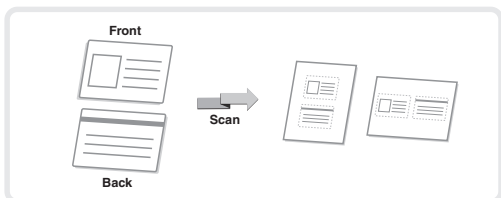

## Scanning many originals at once (Job Build)

A stack of originals higher than the indicator line on the automatic document feeder cannot be fed through the feeder.

The job build function lets you divide the stack of originals into sets, feed each set, and send the sets as a single transmission.

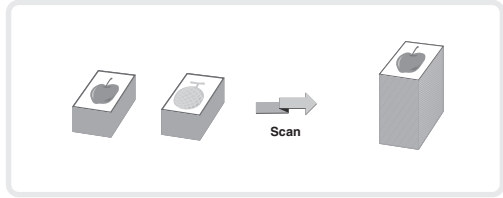

## The machine also has these functions

For detailed information on each of these functions, see "SPECIAL MODES" and "INTERNET FAX RECEPTION FUNCTIONS" in "Chapter 5 - SCANNER / INTERNET FAX" in the Operation Guide.

- Sending an image at a specified time (Timer Transmission)
- Storing scan operations (Program)
- Scanning thin originals (Slow Scan Mode)
- Scanning business cards (Business Card Scan) (Business card feeder is required.)
- Changing the print settings for the transaction report (Transaction Report)
- Forwarding a received Internet fax to a network address (Inbound Routing Settings)

# Document filing

The document filing function is used to store the document or print image on the hard drive when performing a copy, print, or other job. A stored file can be called up and used whenever needed.

This section introduces several of the document filing functions.

- ▶ **DOCUMENT FILING** . . . . . 118
- ▶ **QUICKLY SAVING A JOB (Quick File)** . . . . . 120
- ▶ **APPENDING INFORMATION WHEN STORING A FILE (File)** . . . . . 121
- ▶ **SAVING A DOCUMENT ONLY (Scan to HDD)** . . . . . 124
- ▶ **PRINTING A SAVED FILE** . . . . . 126

# DOCUMENT FILING

The document filing function allows you to save the document image of a copy or image send job, or the data of a print job, as a file on the machine's hard drive.

The stored file can be retrieved and printed or transmitted as needed.

## Uses of the document filing function

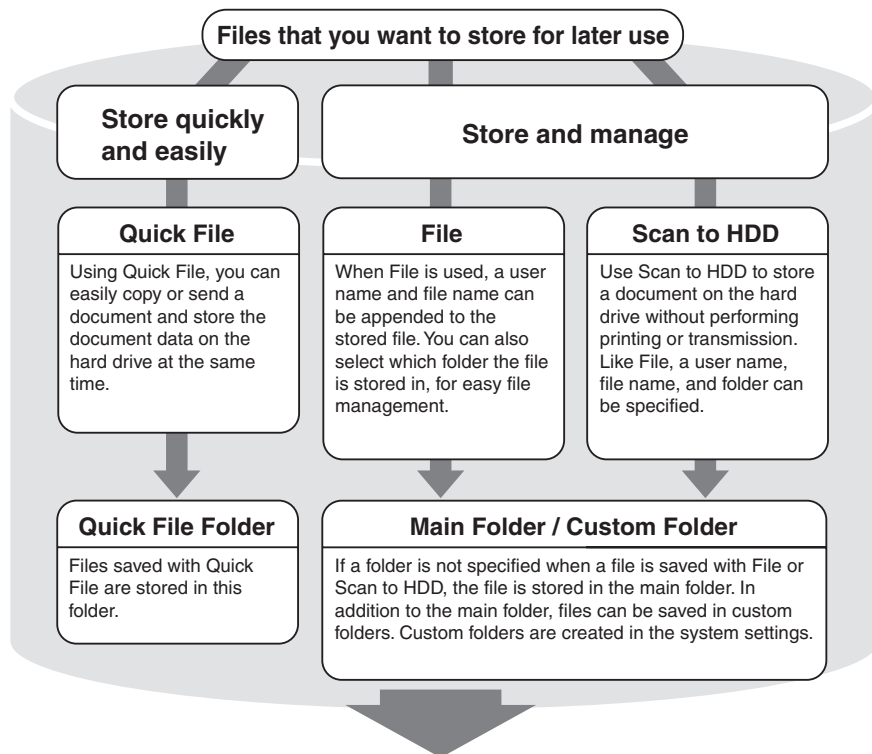
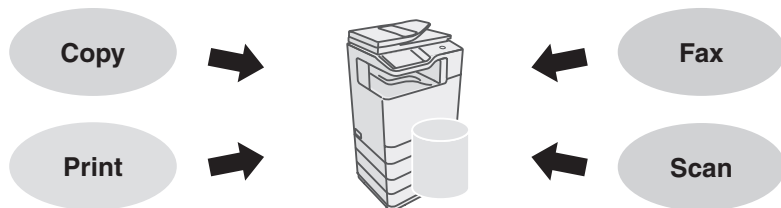

**Stored files can be printed or transmitted whenever needed.**

**A file that has been stored using the printer driver cannot be transmitted.**



# The document filing function is convenient in these situations

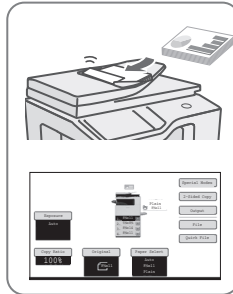
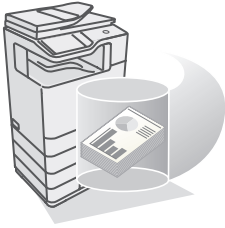

## In this situation...

You prepared copies of a many-page handout for a meeting, but the number of participants suddenly increases and you need to quickly prepare more copies of the handout.

## Document filing is convenient

It takes time to scan all of the pages of the handout. And the copy settings must be selected again. In this situation, there is no need to panic. Simply print the file that you stored using document filing. There is no need to scan the originals or select the copy settings again.

## In this situation...

Forms for daily or weekly reports are kept in the office, but they are often used up and you have to print more using the original file.

## Document filing is convenient

If you store the forms for daily or weekly reports together in a folder, users can obtain forms using the Web page or the operation panel of the machine.

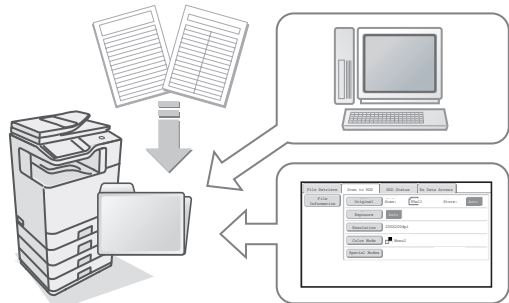

## Features that make the document filing function even more convenient

When user authentication is enabled, "My Folder" can be specified in the user information of the users. When a user retrieves a stored file, "My Folder" appears first, saving the user the trouble of selecting the folder. For information on setting up "My Folder", see "User List" in "Chapter 7 - SYSTEM SETTINGS" in the Operation Guide.

# QUICKLY SAVING A JOB (Quick File)

As an example, the procedure for using "Quick File" while copying is explained below.

Quick File is the easiest way to save a file using the document filing function.

The side to be scanned must be face up!



## 1 Place the originals.

When using the document glass, place the original with the side to be scanned face down.

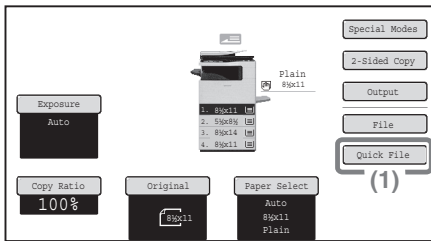

## 2 Select settings in the touch panel.

Select settings in the same way as when making a regular copy.

(1) Touch the [Quick File] key.

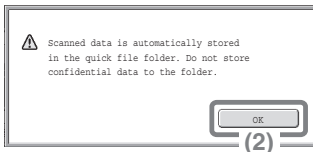

(2) Touch the [OK] key.

## 3 Set the number of copies and then press the [START] key.

The file is stored on the hard drive at the same time as the copy is made.

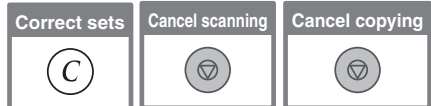
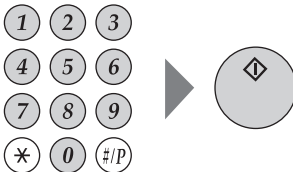

# APPENDING INFORMATION WHEN STORING A FILE (File)

As an example, the procedure for using "File" while copying is explained below. Unlike Quick File, a file name, user name, and folder can be specified when saving a file.

The side to be scanned must be face up!



## 1 Place the originals.

When using the document glass, place the original with the side to be scanned face down.

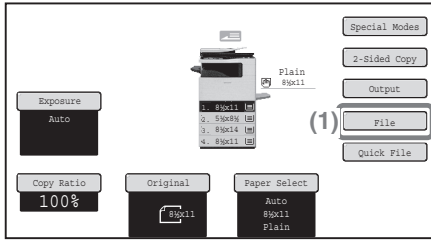

## 2 Select settings in the touch panel.

Select settings in the same way as when making a regular copy.

(1) Touch the [File] key.

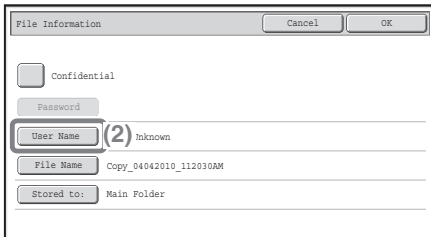

(2) Touch the [User Name] key.

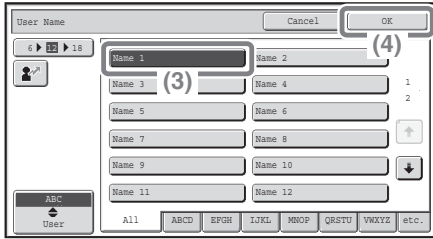

Select settings in the touch panel. (Continued)  
 (3) Touch the [Name 1] key.  
 (4) Touch the [OK] key.

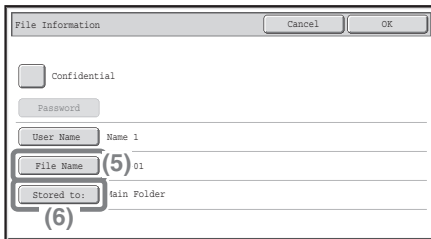

(5) Touch the [File Name] key.  
 A text entry screen appears. Enter a file name.  
 (6) Touch the [Stored to:] key.

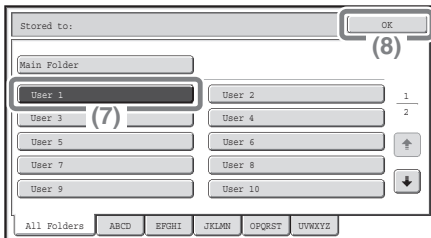

(7) Touch the [User 1] key.  
 (8) Touch the [OK] key.



(9) Touch the [OK] key.

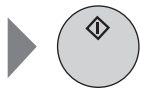
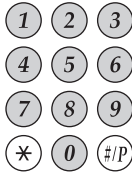

### 3 Set the number of copies and then press the [START] key.

The file is stored on the hard drive at the same time as the copy is made.

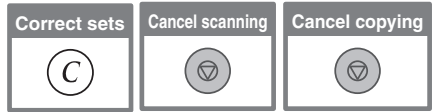

# SAVING A DOCUMENT ONLY (Scan to HDD)

You can save a document without performing a copy, print, or send job. The procedure for storing a document in the main folder is explained below.

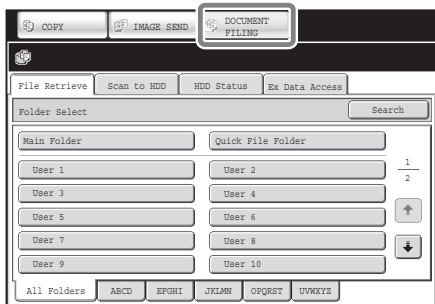

## 1 Touch the [DOCUMENT FILING] key.

The base screen of document filing mode appears.

The side to be scanned must be face up!



## 2 Place the originals.

When using the document glass, place the original with the side to be scanned face down.

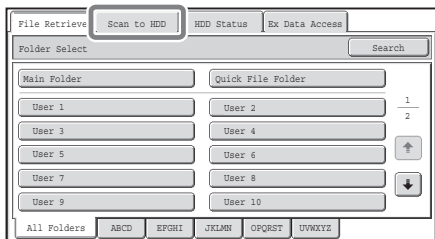

## 3 Touch the [Scan to HDD] tab.

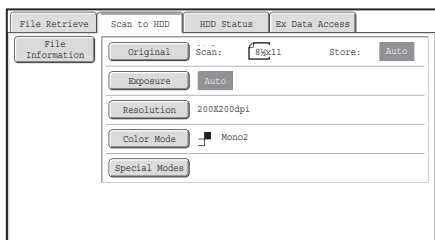

The Scan to HDD base screen appears.

To specify a user name, file name, and folder, touch the [File Information] key.



**4 Press the [START] key.**

# PRINTING A SAVED FILE

You can retrieve a file stored by document filing and print or transmit the file. This section explains how to retrieve and print a file stored in the main folder.

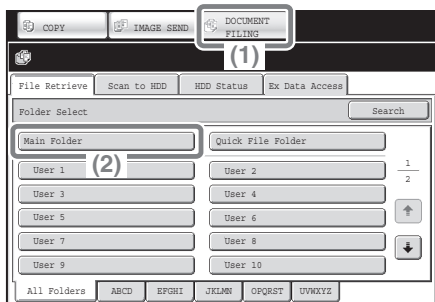

**Select the file and print it.**

**(1) Touch the [DOCUMENT FILING] key.**

**(2) Touch the [Main Folder] key.**

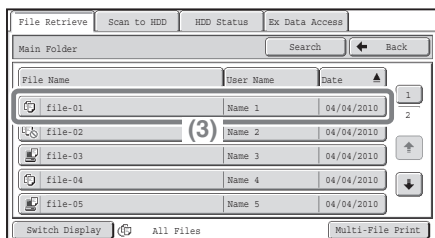

**(3) Touch the key of the file that you wish to retrieve.**

Touch the [Switch Display] key to display the switch display screen. Touch the [Thumbnail] key in the switch display screen to display thumbnail images in the file keys.

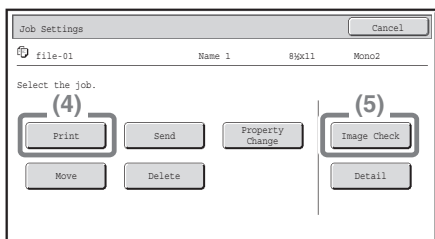

**(4) Touch the [Print] key.**

**(5) Touch the [Image Check] key to check the content of a file.**

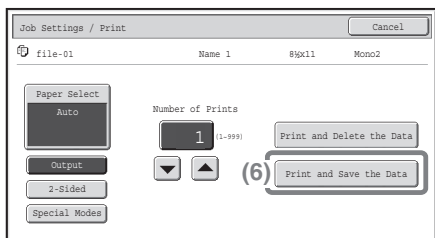

**(6) Touch the [Print and Save the Data] key.**

When [Print and Save the Data] is selected, the file is saved after printing.

To delete the file after printing it, select [Print and Delete the Data].



# System settings

The system settings let you adjust the operation of the machine to suit the needs of your workplace. This section briefly introduces several of the system settings. For detailed explanations of the system settings, see "Chapter 7 - SYSTEM SETTINGS" in the Operation Guide.

► **SYSTEM SETTINGS** ..... **128**

# SYSTEM SETTINGS

The date and time can be set, fax and scan destinations can be stored, document filing folders can be created, and various other settings related to the operation of the machine can be configured in the system settings screen.

The procedure for opening the system settings screen and the items in the screen are explained below.

For detailed explanations of the system settings, see "Chapter 7 - SYSTEM SETTINGS" in the Operation Guide.

## Displaying the system settings screen

SYSTEM  
SETTINGS



Press the [SYSTEM  
SETTINGS] key.

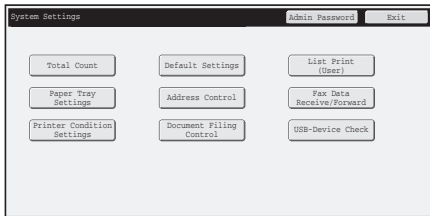

The system settings screen will appear.

The keys that appear will vary depending on what peripheral devices are installed.

## What you can do in the system settings

Settings	Description
Total Count	This displays the total number of pages printed by job type such as copy jobs and print jobs.
Default Settings	This lets you set the clock and change the software keyboard used for text entry.
List Print (User)	This lets you print lists showing the machine status and settings.
Paper Tray Settings	This is used to set the type and size of paper used in each tray, and to store new paper types.
Address Control	Destinations for the image send function can be stored in one-touch keys, and settings can be stored in program keys.

Settings	Description
Fax Data Receive/Forward	This is used to configure settings for receiving faxes and Internet faxes, and for forwarding received faxes and Internet faxes.
Printer Condition Settings	This is used to configure settings for printing without using the printer driver and settings for the printer function.
Document Filing Control	This is used to store, edit, and delete custom folders for the document filing function.
USB-Device Check	This is used to check the connection status of a USB device.

## System settings (administrator)

The system settings (administrator)\* are system settings that can only be configured by the administrator of the machine. To configure these settings, the administrator password must be entered.

However, when user authentication is enabled, users who log in with certain user rights may be able to configure these settings without entering the administrator password. Check with your administrator.

\* Although the manuals for the machine indicate system settings that require administrator rights as "system settings (administrator)", this is only for convenience in explaining the settings. The word "administrator" does not appear in the touch panel or elsewhere on the machine.

For the items of the system settings (administrator), see "Chapter 7 - SYSTEM SETTINGS" in the Operation Guide.



# Troubleshooting

This sections contains answers to frequently asked questions and explains how to remove paper misfeeds.

- ▶ **FREQUENTLY ASKED QUESTIONS . . . . . 132**
- ▶ **REMOVING MISFEEDS . . . . . 138**

# FREQUENTLY ASKED QUESTIONS

## Making a copy of a non-standard size original

The procedure for making a copy of a payment slip or other non-standard size original is explained below.

The "Centering" special mode of copy mode can be selected to position the copied image in the center of the paper.

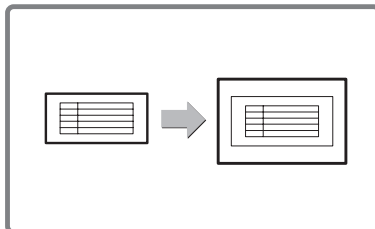

### 1 Place the originals.



If the X dimension (width) of the document is less than 3-1/2" (89 mm) or the Y dimension (height) is less than 4" (100 mm), place the original on the document glass.

When using the automatic document feeder, use "Slow Scan Mode" for a thin original.

### 2 Enter the original size.

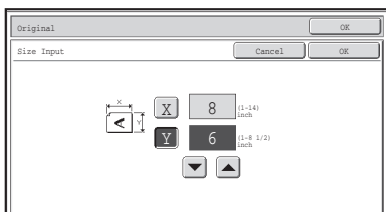

From the base screen of copy mode, touch [Original] then [Size Input].

### 3 Place paper in the bypass tray.

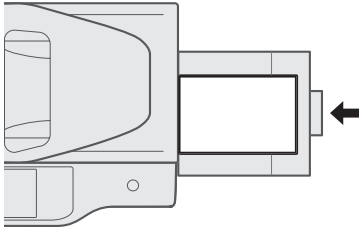

The bypass tray is used here to copy onto paper that is not loaded in any of the paper trays of the machine.

Type : Recycled  
Size : 8-1/2" x 11"

### 4 Select the bypass tray.

From the base screen of copy mode, touch [Paper Select] and then "Bypass tray paper type".

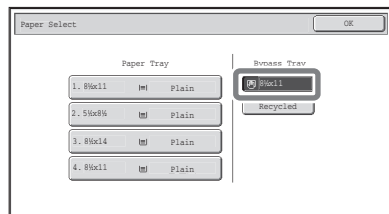
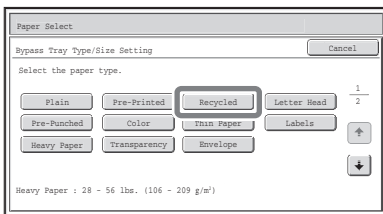

# Printing on envelopes

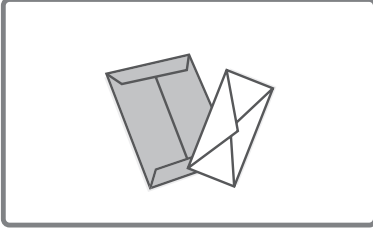

The procedure for printing on an envelope is explained below. Only the name and address side of an envelope can be printed on.

It is recommended that you do a test print to check the print result before using an envelope.

## 1 Place paper in the bypass tray.

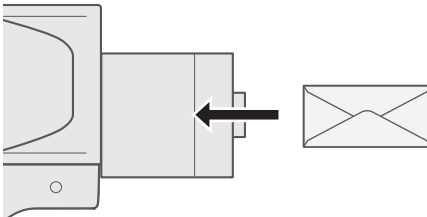

Print on the name and address side

## 2 Tray Settings.

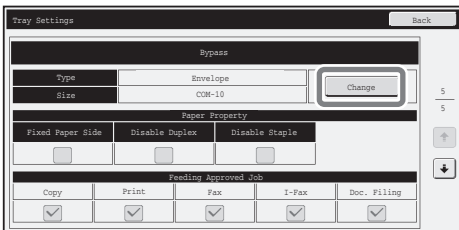

Type : Envelope  
Size : Select the envelope size



### 3 Select settings in the printer driver.

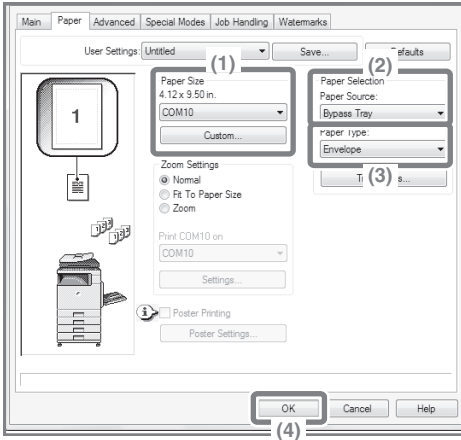

(1) Select the size of the envelope in "Paper Size".

(2) Select "Bypass Tray" from "Paper Source" in "Paper Selection".

(3) Select [Envelope] in "Paper Type".

If needed, select the "Rotate 180 degrees" checkbox () in "Image Orientation" on the [Main] tab.

(4) Click the [OK] button.

# Changing the paper size used for a print job

When the size of paper specified for a print job is not loaded in any of the machine's paper trays, follow the steps below to change the paper size.

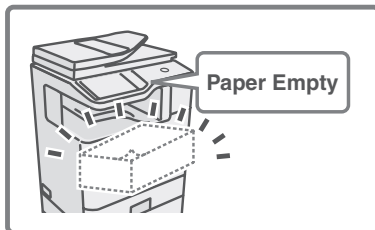

## 1 Check details on the job.

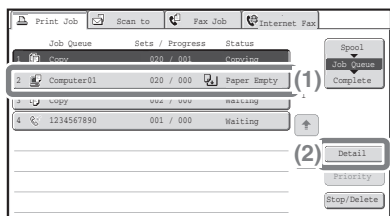

Press the [JOB STATUS] key on the operation panel to display the job status screen.

**(1) Select the job whose status is [Paper Empty].**

**(2) Touch the [Detail] key.**

To delete the job, you can press the [Stop/Delete] key.

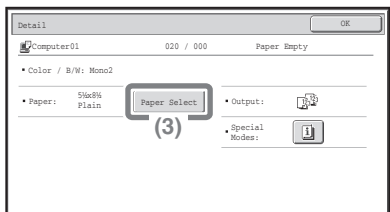

**(3) Check the paper size specified for the job in the detail screen, and touch the [Paper Select] key.**

## 2 Change the paper size used for the job.

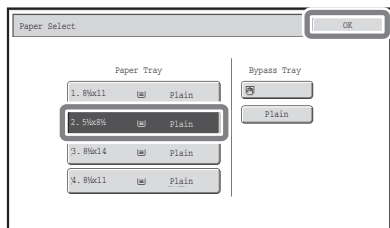

Select the paper size on which you wish to print the job from the set paper sizes.

To avoid cutting off part of the image, select a paper size that is larger than the paper size specified for the job.

## Adjusting the volume of the ringer

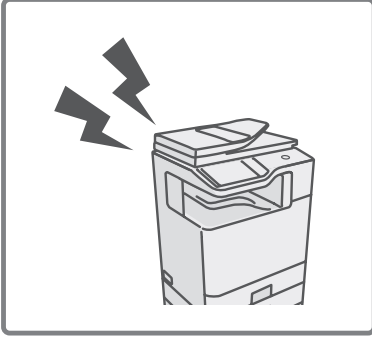

If the ringing sound made when the machine receives a fax is too loud or too soft, follow the steps below to adjust the volume.

The fax ringer volume is adjusted in the system settings (administrator).

Press the [SYSTEM SETTINGS] key on the operation panel, touch [Image Send Settings] - [Fax Settings] - [Fax Default Settings] - [Speaker Settings] - [Ringer Volume] in that order, and then select the desired volume.

## Checking the machine's communication record

To check the machine's record of communication using the image send function, follow the steps below to print the image sending activity report.

The image sending activity report is printed from the system settings (administrator).

Press the [SYSTEM SETTINGS] key on the operation panel, and then touch [List Print (Administrator)] - [Image Sending Activity Report] to print the report.

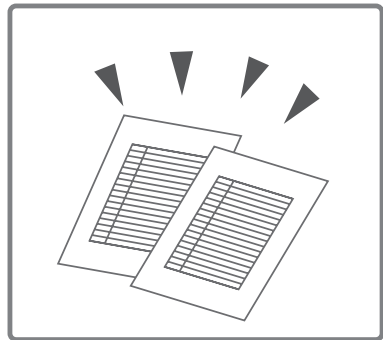

# REMOVING MISFEEDS

When a paper misfeed occurs, the message "A misfeed has occurred." will appear in the touch panel and printing and scanning will stop. In this event, touch the [Information] key in the touch panel. When the key is touched, instructions for removing the misfeed will appear. Follow the instructions. When the misfeed is cleared, the message will automatically clear.

The blinking  mark in the image at left indicates the approximate position of the misfeed.

## Misfeed location

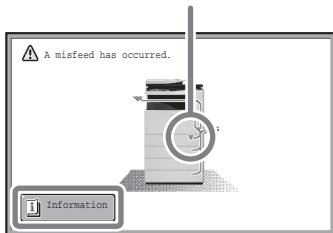

Touch the [Information] key to display the following screen.

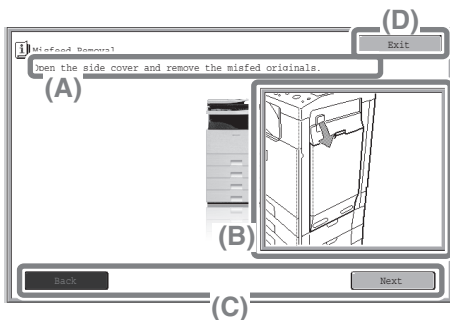

**(A)**Instructions for removing the misfeed appear here.

**(B)**Animation showing what to do.

**(C)**Display the previous screen or the next screen.

**(D)**This closes the information screen.

The information screen cannot be closed until the misfeed is removed.

- While the message appears, printing and scanning cannot be resumed.
- If the message does not clear even after the misfeed has been removed, the causes below are possible. Check once again.
  - The misfeed was not correctly removed.
  - A torn piece of paper remains in the machine.
  - A cover or unit that was opened or moved to remove the misfeed was not returned to its original position.

For detailed procedures for removing misfeeds, see "REMOVING MISFEEDS" in "Chapter 8 - TROUBLESHOOTING" in the Operation Guide.

## Please note

---

- For information on your operating system, please refer to your operating system manual or the online Help function.
- The explanations of screens and procedures in a Windows environment are primarily for Windows Vista®. The screens may vary depending on the version of the operating system or the software application.
- The explanations of screens and procedures in a Macintosh environment are based on Mac OS X v10.4 in the case of Mac OS X. The screens may vary depending on the version of the operating system or the software application.
- Wherever "xx-xxxx" appears in this manual, please substitute your model name for "xx-xxxx".
- Considerable care has been taken in preparing this manual. If you have any comments or concerns about the manual, please contact your dealer or nearest SHARP Service Department.
- This product has undergone strict quality control and inspection procedures. In the unlikely event that a defect or other problem is discovered, please contact your dealer or nearest SHARP Service Department.
- Aside from instances provided for by law, SHARP is not responsible for failures occurring during the use of the product or its options, or failures due to incorrect operation of the product and its options, or other failures, or for any damage that occurs due to use of the product.

## Warning

---

- Reproduction, adaptation or translation of the contents of the manual without prior written permission is prohibited, except as allowed under copyright laws.
- All information in this manual is subject to change without notice.

## Illustrations and the operation panel shown in this manual

---

The peripheral devices are generally optional, however, some models include certain peripheral devices as standard equipment.

The explanations in this manual assume that 500-sheet paper feed units (total of four trays) are installed on the MX-B401.

For some functions and procedures, the explanations assume that devices other than the above are installed.

The display screens, messages, and key names shown in the manual may differ from those on the actual machine due to product improvements and modifications.





# SHARP®

## SHARP ELECTRONICS CORPORATION

1 Sharp Plaza, Mahwah, New Jersey 07495-1163.

[www.sharpusa.com](http://www.sharpusa.com)

## SHARP ELECTRONICS OF CANADA LTD.

335 Britannia Road East, Mississauga, Ontario, L4Z 1W9

## SHARP CORPORATION



This manual has been printed using a vegetable-based soy oil ink to help protect the environment.

PRINTED IN CHINA  
2009B KS1  
TINSE4377FCZZ



## Free Manuals Download Website

<http://myh66.com>

<http://usermanuals.us>

<http://www.somanuals.com>

<http://www.4manuals.cc>

<http://www.manual-lib.com>

<http://www.404manual.com>

<http://www.luxmanual.com>

<http://aubethermostatmanual.com>

Golf course search by state

<http://golfingnear.com>

Email search by domain

<http://emailbydomain.com>

Auto manuals search

<http://auto.somanuals.com>

TV manuals search

<http://tv.somanuals.com>