

SHARP

Important

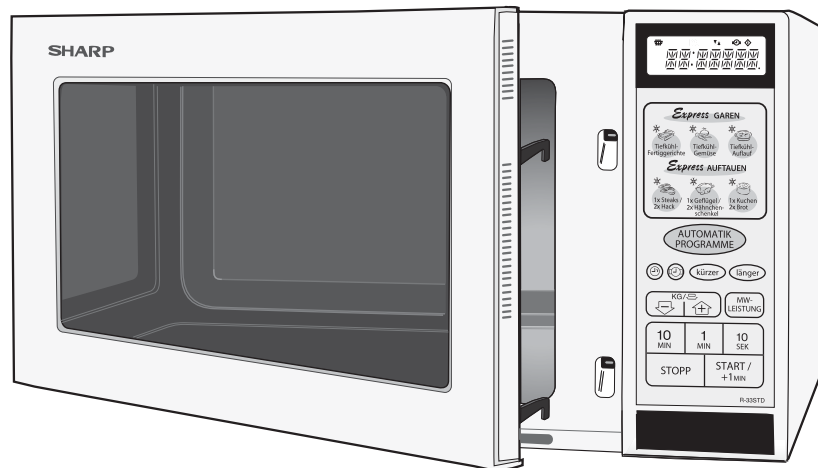

R-33STD MICROWAVE OVEN OPERATION MANUAL WITH COOKBOOK

OPERATION MANUAL

This operation manual contains important information which you should read carefully before using your microwave oven.

IMPORTANT: There may be a serious risk to health if this operation manual is not followed or if the oven is modified so that it operates with the door open.

900 W (IEC 60705)

ENGLISH

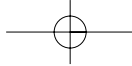

Dear Customer,

Congratulations on acquiring your new microwave oven, which from now on will make your kitchen chores considerably easier.

You will be pleasantly surprised by the kinds of things you can do with a microwave. Not only can you use it for rapid defrosting or heating up of food, you can also prepare whole meals.

In our test kitchen our microwave team has gathered together a selection of the most delicious international recipes which are quick and simple to prepare.

Be inspired by the recipes we have included and prepare your own favourite dishes in your microwave oven.

There are so many advantages to having a microwave oven which we are sure you will find exciting:

- Food can be prepared directly in the serving dishes, leaving less to wash up.
- Shorter cooking times and the use of little water and fat ensure that many vitamins, minerals and characteristic flavours are preserved.

We advise you to read the cookery book guide and operating instructions carefully.

You will then easily understand how to use your oven.

Enjoy using your microwave oven and trying out the delicious recipes.

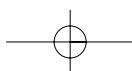
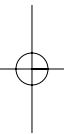
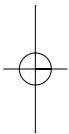

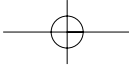

CONTENTS



OVEN AND ACCESSORIES2

CONTROL PANEL3

IMPORTANT SAFETY INSTRUCTIONS4-6

INSTALLATION6

BEFORE OPERATION6

STOP KEY7

SETTING THE CLOCK7

MICROWAVE POWER LEVELS8

MICROWAVE COOKING9

OTHER CONVENIENT FUNCTIONS10-12

EXPRESS COOK & EXPRESS DEFROST13

EXPRESS COOK & EXPRESS DEFROST CHART14-15

AUTO COOK OPERATION16

AUTO COOK CHART16-17

RECIPES FOR AUTO COOK AC-718

RECIPES FOR AUTO COOK AC-819

CARE AND CLEANING20

SERVICE CALL CHECK20

SPECIFICATIONS21

COOKBOOK22-42

SERVICE ADDRESSES43-48

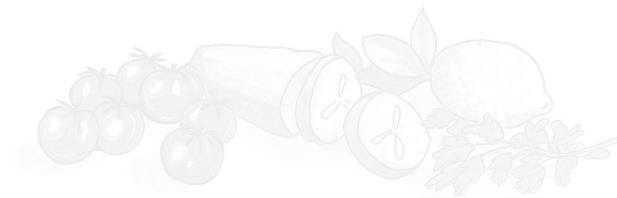

ENGLISH

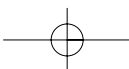



OVEN AND ACCESSORIES

OVEN

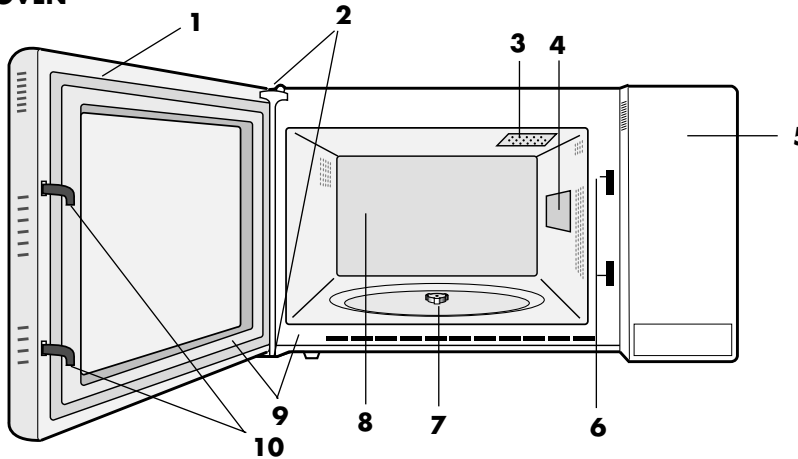

- 1** Door
- 2** Door hinges
- 3** Oven lamp
- 4** Waveguide cover
- 5** Control panel
- 6** Door lock openings
- 7** Coupling
- 8** Oven cavity
- 9** Door seals and sealing surfaces
- 10** Door safety latches
- 11** Ventilation openings
- 12** Outer cabinet
- 13** Power supply cord

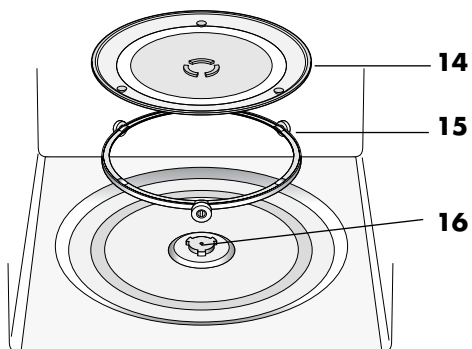
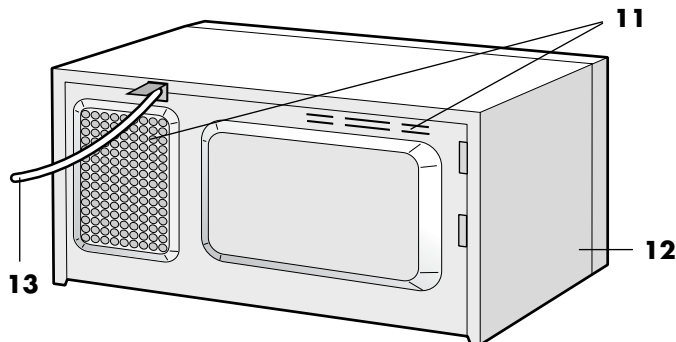

ACCESSORIES:

Check to make sure the following accessories are provided:

(14) Turntable **(15)** Roller stay **(16)** Coupling
Place the turntable support in the centre of the oven floor so that it can freely rotate around the coupling. Place the turntable onto the turntable support so that it locates firmly into the coupling.

To avoid turntable damage, ensure dishes or containers are lifted clear of the turntable rim when removing them from the oven.

NOTE: When you order accessories, please mention two items: part name and model name to your dealer or SHARP authorised service agent.

CONTROL PANEL

CONTROL PANEL

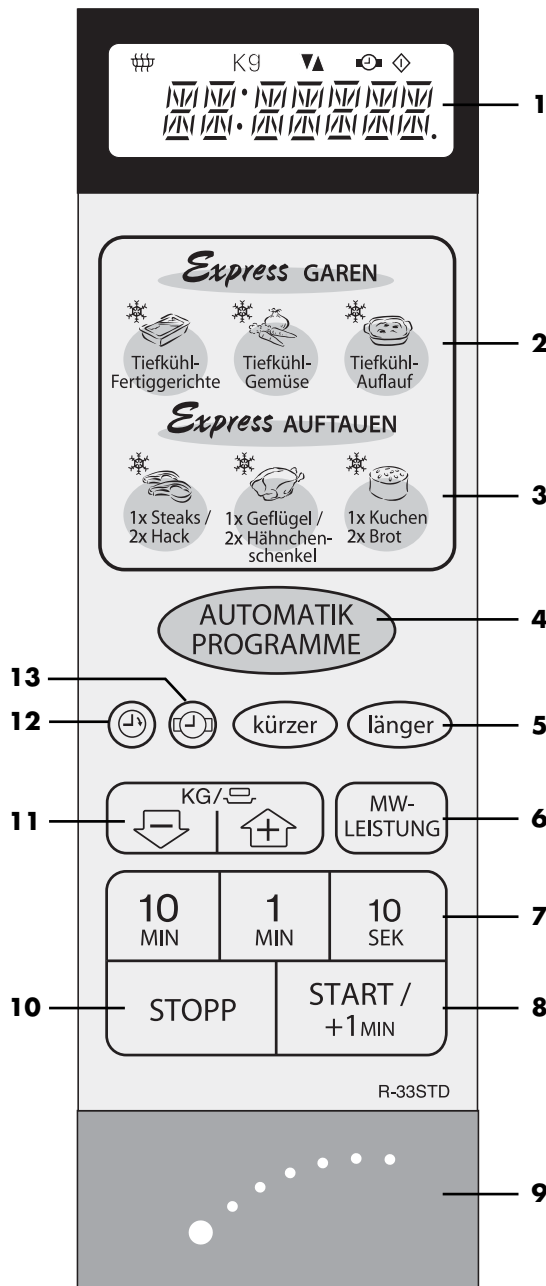

- 1 Digital Display
- 2 **EXPRESS COOK** keys
- 3 **EXPRESS DEFROST** keys
- 4 **AUTO COOK** key
- 5 **LESS** and **MORE** keys
- 6 **POWER LEVEL** key
- 7 **TIME** keys
- 8 **START/+1 min** key
- 9 **DOOR OPEN** button
- 10 **STOP** key
- 11 **WEIGHT DECREASE/INCREASE** keys
- 12 **TIMER** key
- 13 **CLOCK** key



IMPORTANT SAFETY INSTRUCTIONS

IMPORTANT SAFETY INSTRUCTION: READ CAREFULLY AND KEEP FOR FUTURE REFERENCE

To avoid the danger of fire.

The microwave oven should not be left unattended during operation. Power levels that are too high, or cooking times that are too long, may overheat foods resulting in a fire.

In cases where the oven is to be installed into a kitchen cabinet, the installation frame EBR-45ST licensed by SHARP must be used. This is available from your dealer. Refer to the frame installation instructions for A type models or ask your dealer for the proper instruction procedure. Only the use of this frame will guarantee the safety and quality of the product.

The electrical outlet must be readily accessible so that the unit can be unplugged easily in an emergency.

The AC power supply must be 230V, 50Hz, with a minimum 10A distribution line fuse, or a minimum 10A distribution circuit breaker.

It is recommended that a separate circuit serving only this appliance be provided.

Do not place the oven in areas where heat is generated. For example, close to a conventional oven.

Do not install the oven in an area of high humidity or where moisture may collect.

Do not store or use the oven outdoors.

If food being heated begins to smoke, DO NOT OPEN THE DOOR. Turn off and unplug the oven and wait until the food has stopped smoking. Opening the door while food is smoking may cause a fire

Use only microwave-safe containers and utensils. See Page 22 in the cookbook.

Do not leave the oven unattended when using disposable plastic, paper or other combustible food containers

Clean the waveguide cover, the oven cavity, the turntable and roller stay after use. These must be dry and free from grease. Built-up grease may overheat and begin to smoke or catch fire.

Do not place flammable materials near the oven or ventilation openings. Do not block the ventilation openings.

Remove all metallic seals, wire twists, etc., from food and food packages. Arcing on metallic surfaces may cause a fire.

Do not use the microwave oven to heat oil for deep frying. The temperature cannot be controlled and the oil may catch fire.

To make popcorn, use only special microwave popcorn makers.

Do not store food or any other items inside the oven.

Check the settings after you start the oven to ensure the oven is operating as desired.

See the corresponding hints in this operation manual and the cookery book section.

To avoid the possibility of injury

WARNING:

Do not operate the oven if it is damaged or malfunctioning. Check the following before use:

- The door; make sure the door closes properly and ensure it is not misaligned or warped.
- The hinges and safety door latches; check to make sure they are not broken or loose.
- The door seals and sealing surfaces; ensure that they have not been damaged.
- Inside the oven cavity or on the door; make sure there are no dents.
- The power supply cord and plug; ensure that they are not damaged.

Never adjust, repair or modify the oven yourself. It is hazardous for anyone other than a competent person to carry out any service or repair operation which involves the removal of a cover which gives protection against exposure to microwave energy.

Do not operate the oven with the door open or alter the door safety latches in any way.

Do not operate the oven if there is an object between the door seals and sealing surfaces.

Do not allow grease or dirt to build up on the door seals and adjacent parts. Follow instructions for "Care and Cleaning", Page 20.

Individuals with PACEMAKERS should check with their doctor or the manufacturer of the pacemaker for precautions regarding microwave ovens.

To avoid the possibility of electric shock

Under no circumstances should you remove the outer cabinet.

Never spill or insert any objects into the door lock openings or ventilation openings. In the event of a spill, turn off and unplug the oven immediately, and call an authorised SHARP service agent.

IMPORTANT SAFETY INSTRUCTIONS



Do not immerse the power supply cord or plug in water or any other liquid.

Do not let the power supply cord hang over the edge of a table or work surface.

Keep the power supply cord away from heated surfaces, including the rear of the oven.

Do not attempt to replace the oven lamp yourself or allow anyone who is not an electrician authorised by SHARP to do so. If the oven lamp fails, please consult your dealer or an authorised SHARP service agent.

If the power supply cord of this appliance is damaged, it must be replaced with a special cord. The exchange must be made by an authorised SHARP service agent.

To avoid the possibility of explosion and sudden boiling:

WARNING: Liquids and other foods must not be heated in sealed containers since they are liable to explode.

Never use sealed containers. Remove seals and lids before use. Sealed containers can explode due to a build up of pressure even after the oven has been turned off.

Take care when microwaving liquids. Use a wide-mouthed container to allow bubbles to escape.

Microwave heating of beverages can result in delayed eruptive boiling, therefore care has to be taken when handling the container.

To prevent sudden eruption of boiling liquid and possible scalding:

1. Stir liquid prior to heating/reheating.
2. It is advisable to insert a glass rod or similar utensil into the liquid whilst reheating.
3. Let liquid stand for at least 20 seconds in the oven at the end of cooking time to prevent delayed eruptive boiling.

Do not cook eggs in their shells, and whole hard boiled eggs should not be heated in microwave ovens since they may explode even after microwave cooking has ended. To cook or reheat eggs which have not been scrambled or mixed, pierce the yolks and the whites, or the eggs may explode. Shell and slice hard boiled eggs before reheating them in the microwave oven.

Pierce the skin of such foods as potatoes, sausages and fruit before cooking, or they may explode.

To avoid the possibility of burns

Use pot holders or oven gloves when removing food from the oven to prevent burns.

Always open containers, popcorn makers, oven cooking bags, etc., away from the face and hands to avoid steam burns.

To avoid burns, always test food temperature and stir before serving and pay special attention to the temperature of food and drink given to babies, children or the elderly.

Temperature of the container is not a true indication of the temperature of the food or drink; always check the food temperature.

Always stand back from the oven door when opening to avoid burns from escaping steam and heat.

Slice stuffed baked foods after heating to release steam and avoid burns.

Keep children away from the door to prevent them burning themselves.

To avoid misuse by children

WARNING: Only allow children to use the oven without supervision when adequate instructions have been given so that the child is able to use the oven in a safe way and understands the hazards of improper use.

Do not lean or swing on the oven door. Do not play with the oven or use it as a toy.

Children should be taught all important safety instructions: use of pot holders, careful removal of food coverings; paying special attention to packaging (e.g. self-heating materials) designed to make food crisp, as they may be extra hot.

Other warnings

Never modify the oven in any way.

Do not move the oven while it is in operation.

This oven is for home food preparation only and may only be used for cooking food. It is not suitable for commercial or laboratory use.

To promote trouble-free use of your oven and avoid damage.

Never operate the oven when it is empty.

When using a browning dish or self-heating material, always place a heat-resistant insulator such as a porcelain plate under it to prevent damage to the turntable and roller stay due to heat stress. The preheating time specified in the dishes instructions must not be exceeded.

Do not use metal utensils, which reflect microwaves and may cause electrical arcing. Do not put cans in the oven.



IMPORTANT SAFETY INSTRUCTIONS

Use only the turntable and the roller stay designed for this oven.

To prevent the turntable from breaking:

- Before cleaning the turntable with water, leave the turntable to cool.
- Do not put hot foods or hot utensils on a cold turntable.
- Do not put cold foods or cold utensils on a hot turntable.

Do not place anything on the outer cabinet during operation.

NOTE:

If you are unsure how to connect your oven, please consult an authorised, qualified electrician.

Neither the manufacturer nor the dealer can accept any liability for damage to the oven or personal injury resulting from failure to observe the correct electrical connection procedure.

Water vapour or drops may occasionally form on the oven walls or around the door seals and sealing surfaces. This is a normal occurrence and is not an indication of microwave leakage or a malfunction.



INSTALLATION

- Remove all packing materials from the inside of the oven cavity. Discard the loose polythene sheet from between the door and cavity. Remove the feature sticker, if attached, from the **outside** of the oven door.

Do not remove the protective film attached to the **inside** of the door

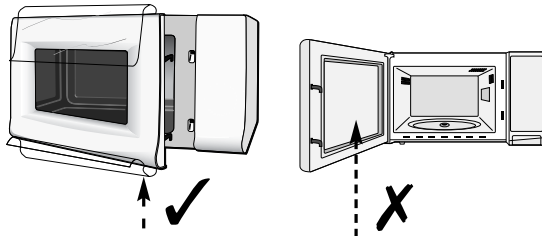

- Check the oven carefully for any signs of damage.

- Place the oven on a flat, level surface strong enough to support the oven's weight plus the heaviest item likely to be cooked.
- Ensure there is a minimum free space above the oven of 19.5 cm.

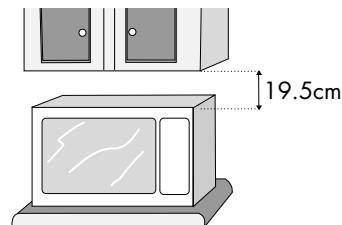

- Securely connect the plug of the oven to a standard earthed (grounded) household electrical outlet.



BEFORE OPERATION

Plug in the oven.

- The oven display will flash:
- Press the **STOPP** key, the display will show:

To set the clock, see page 7.

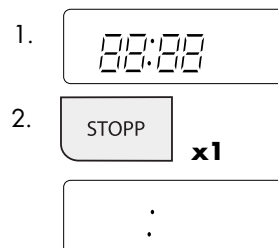

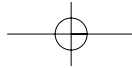

STOP KEY



Use of the **STOP** key:

1. Erasing a mistake during programming.
2. Stopping the oven temporarily during cooking.
3. Cancelling a programme during cooking by pressing the **STOP** key twice.



SETTING THE CLOCK

There are two setting modes: 12 hour clock and 24 hour clock.

1. To set the 12 hour clock, press the clock key once  will appear in the display.
2. To set the 24 hour clock, press the clock key twice  will appear in the display.



To set the clock, follow the example below.

Example:

To set the 24 hour clock to 23:35

1. Choose the 24-hour clock by pressing the **CLOCK** key twice.
2. Set the hours: Press the **10 MIN** key twice. Press the **1 MIN** key three times.
3. Change from hours to minutes by pressing the **CLOCK** key once.



4. Set the minutes: Press the **10 MIN** key three times. Press the **1 MIN** key five times.



Check the display

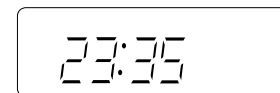

NOTE:

1. Press the **STOP** key if you make a mistake during programming.
2. If the electrical power supply to your microwave oven is interrupted, the display will intermittently show  after the power is reinstated. If this

occurs during cooking, the programme will be erased. The time of day will also be erased.

3. When you want to reset the time of day, follow the above example again.

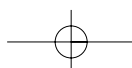



MICROWAVE POWER LEVELS

Your oven has 5 power levels. To choose the power level for cooking, follow the advice given in the recipe section. Generally the following recommendations apply:

HIGH - (900 W) used for fast cooking or reheating e.g. soup, casseroles, canned food, hot beverages, vegetables, fish, etc.

MEDIUM HIGH - (630 W) used for longer cooking of dense foods such as roast joints, meat loaf and plated meals, also for sensitive dishes such as cheese sauce and sponge cakes. At this reduced setting, the sauce will not boil over and food will cook evenly without over cooking at the sides.

MEDIUM - (450 W) for dense foods which require a long cooking time when cooked conventionally, eg. beef dishes, it is advisable to use this power setting to ensure the meat will be tender.

MEDIUM LOW - (270 W Defrost setting) to defrost, select this power setting, to ensure that the dish defrosts evenly. This setting is also ideal for simmering rice, pasta, dumplings and cooking egg custard.

LOW - (90 W) For gentle defrosting, eg. cream gateaux or pastry.

- To set the power, touch the **POWER LEVEL** key until the desired level is displayed.
- If the **POWER LEVEL** key is touched once, will be displayed. If you miss your desired level, continue touching the **POWER LEVEL** key until you reach the level again.
- **If the level is not selected, the level 900 W is automatically set.**



MICROWAVE COOKING



Your oven can be programmed for up to 99 minutes 90 seconds. (99.90).

Example: Suppose you want to heat soup for 2 minutes and 30 seconds on 630 W microwave power.

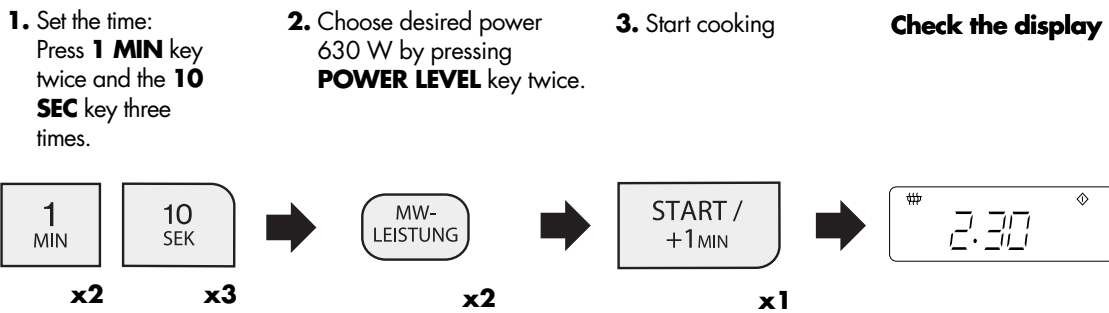

NOTES:

1. When the door is opened during the cooking process, the cooking time on the digital display stops automatically. The cooking time starts to count down again when the door is closed and the **START/+1 min** key is pressed.
2. If you wish to know the power level during cooking, press the **POWER LEVEL** key. As long as your finger is touching the **POWER LEVEL** key, the power level will be displayed.
3. When the operation of the oven is finished, the time of day will reappear, if set, on the display.



OTHER CONVENIENT FUNCTIONS

1. MULTIPLE SEQUENCE COOKING

A maximum of 3 sequences can be input, consisting of manual cooking time and mode.

Example:

To cook: 5 minutes on 900 W power (Stage 1)
16 minutes on 270 W power (Stage 2)

STAGE 1

1. Enter the desired cooking time by pressing the **1 MIN** key 5 times.
2. Choose the desired power level by pressing the **POWER LEVEL** key once.



x5



x1

STAGE 2

3. Enter the desired cooking time by pressing the **10 MIN** key once and the **1 MIN** key 6 times.
 4. Choose the desired power level by pressing the **POWER LEVEL** key four times.
 5. Press the **START/+1 min** key once to begin cooking.
- Check the display**



x1

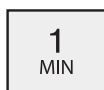

x6



x4

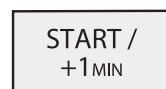

x1

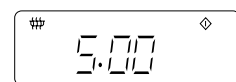

(The oven will begin to cook for 5 minutes on 900 W, and then for 16 minutes on 270 W).

OTHER CONVENIENT FUNCTIONS



2. LESS / MORE keys.

The **LESS** (▼) and **MORE** (▲) keys allow you to easily decrease or increase programmed setting times, (for a less well or more well cooked result), used for **EXPRESS COOK**, **EXPRESS DEFROST** and **AUTO COOK** or when cooking is underway.

a) Changing the pre-programmed time setting.

Example:

Suppose you want to cook 600 g of Frozen Gratin using the **EXPRESS COOK** and **MORE** (▲) keys.

1. Press the **FROZEN GRATIN** key once.



x1

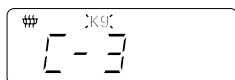

2. Press the **WEIGHT DECREASE/INCREASE** key until the correct weight appears in the display.

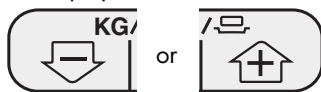

x1

x5

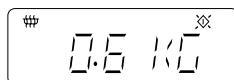

3. Choose the desired result (well cooked) by pressing the **MORE** key once.

länger

x1

4. Press the **START/+1 min** key once to begin cooking.



x1

Check the display

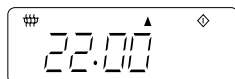

NOTES:

- To cancel **LESS** or **MORE** press the same key again.
- To change **MORE** to **LESS** simply press the **LESS** (▼) key.
- To change **LESS** to **MORE** simply press the **MORE** (▲) key.

b) Changing the heating time while the oven is operating:

The cooking time can be decreased or increased in 1 minute steps each time the **LESS** (▼) and **MORE** (▲) keys are pressed.



OTHER CONVENIENT FUNCTIONS

3. MINUTE PLUS FUNCTION

The **START/+ 1 min** key allows you to operate the two following functions:

a. Direct start

You can directly start cooking on 900 W microwave power for 1 minute by pressing the **START/+ 1 min** key.

NOTE:

To avoid the misuse by children the **START/+ 1 min** key can be used only within 3 minutes after preceding operation, i.e., closing the door, pressing the **STOP** key or cooking completion.

b. Extend the cooking time

You can extend the cooking time for multiples of 1 minute if the key is pressed while the oven is in operation.



START /
+1 MIN

4. TO CHECK THE POWER LEVEL

To check the microwave power level during cooking press the **POWER LEVEL** key.

As long as your finger is touching the **POWER LEVEL** key the power level will be displayed.

The oven continues to count down although the display shows the power level.



MW-
LEISTUNG

x1

5. TIMER FUNCTION

You can use the timer for timing where microwave cooking is not involved for example, to time boiled eggs cooked on a conventional hob.

Example:

To set the timer for 5 minutes.

1. Press the **TIMER** key once.

2. Press the **1 MIN** key five times.

3. Press the **START/+ 1 min** key to start the timer.

Check the display



x1

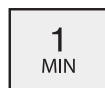

x5



x1

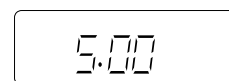

EXPRESS COOK & EXPRESS DEFROST



The **EXPRESS COOK** and **EXPRESS DEFROST** functions automatically work out the correct cooking mode and cooking time of the foods illustrated below.

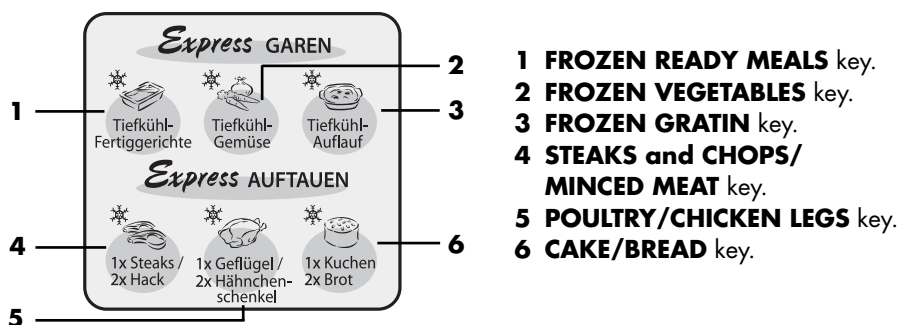

What you need to know when using **EXPRESS COOK** and **EXPRESS DEFROST**:

1. Input the menu by pressing the desired key. Each **EXPRESS COOK** key has one menu, but each **EXPRESS DEFROST** key has two menus. If you want to defrost using an **EXPRESS DEFROST** key, press the desired **EXPRESS DEFROST** key until the desired menu number appears on the display.
2. To set the weight press the **WEIGHT DECREASE/INCREASE** () key until the desired weight is displayed. Enter the weight of the food only. Do not include the weight of the container. For food weighing more or less than the weights/quantities given in the cooking charts, cook using manual operation (see separate cookery book).
3. To start cooking, press the **START/+ 1 min** key.

NOTES:

- The programmed cooking times are average times. If you want to alter the cooking times of **EXPRESS COOK** and **EXPRESS DEFROST**, use the **LESS** (\blacktriangledown) or **MORE** (\blacktriangle) keys. For best results use the cooking chart instructions.
- When manipulation is required (eg: to turn food over) the oven will stop and the audible signal will sound, the display will show the necessary action. To continue cooking, press the **START/+ 1 min** key.
- The final temperature of the food will vary according to its initial temperature. Check food is piping hot after cooking. If necessary, you can extend the cooking time. Always refer to the cooking charts given in the separate cookery book.

Example: Suppose you want to cook 600 g of Frozen Gratin.



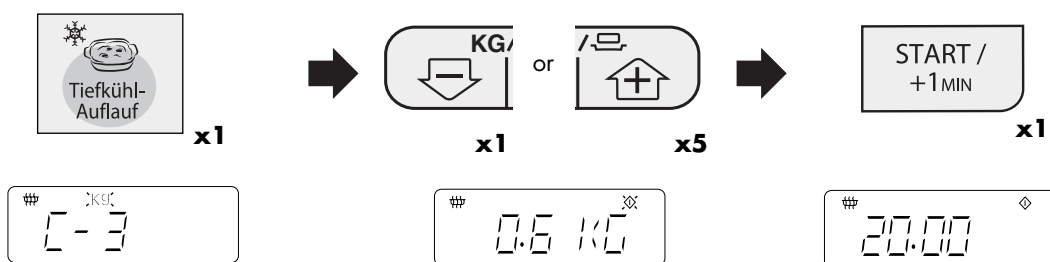



1. Press the **FROZEN GRATIN** key once.
2. Press the **WEIGHT DECREASE/INCREASE** key until the correct weight appears in the display.
3. Press the **START/+ 1 min** key once to begin cooking.



ENGLISH





EXPRESS COOK & EXPRESS DEFROST CHART

MENU NO.	WEIGHT (Increasing Unit) / UTENSILS	PROCEDURE
C-1 Cook  Frozen Ready Meals (initial temp -18° C) e.g. stirrable foods, noodles bolognese, chilli con carne etc.	0.3 - 1.0 kg (100 g) Casserole dish & plastic wrap or lid • If the manufacturer instructs to add water, please calculate the total amount for the programme with the additional liquid	<ul style="list-style-type: none"> • Transfer meal to suitable microwave-proof dish. • Add some liquid if recommended by the manufacturer. • Cover with microwave plastic wrap or lid. • Cook without cover if the manufacturer instructs. • When the audible signal sounds, stir and re-cover. • After cooking, stir and let stand for approx. 1 - 2 minutes.
C-2 Cook  Frozen Vegetables (initial temp -18° C) e.g. Brussel sprouts, green beans, peas, mixed vegetables, broccoli	0.1 - 0.6 kg (100 g) Casserole dish & plastic wrap or lid	<ul style="list-style-type: none"> • Add 1 tbsp water per 100 g. (For mushrooms no additional water is necessary). • Cover with microwave plastic wrap or lid. • When the oven stops and the audible signals sound, stir and re-cover. • After cooking, let stand for approx. 1-2 minutes. <p>NOTE: If frozen vegetables are compacted together, cook manually.</p>
C-3 Cook  Frozen Gratin (initial temp -18° C) e.g. lasagne, macaroni gratin etc.	0.2 - 0.6 kg (100 g) Shallow, oval gratin dish and wrap or original container and wrap	<ul style="list-style-type: none"> • Remove the frozen gratin from the package. If the container is not suitable for microwave ovens, place in a gratin dish and cover with a microwave wrap. • If the container is suitable for microwave ovens, remove original paper cover and cover with microwave wrap. • After cooking, let stand for approx. 5 minutes.
D1-1 Defrost  Steaks and Chops (initial temp -18° C)	0.2 - 1.0 kg (100 g) (see note on page 15)	<ul style="list-style-type: none"> • Place the food on a plate in the centre of the turntable. • When the oven stops and the audible signals sound, turn the food over, rearrange and separate. Shield the thin parts and warm spots with aluminium foil. • After defrosting, wrap in aluminium foil for 10 - 15 minutes, until thoroughly defrosted.
D1-2 Defrost  Minced Meat (initial temp -18° C)	0.2 - 1.0 kg (100 g) Cling film (see note on page 15)	<ul style="list-style-type: none"> • Cover the turntable with cling film. • Place the block of minced meat onto the turntable. • When the oven stops and the audible signals sound, turn the food over. Remove the defrosted parts if possible. • After defrosting, cover in aluminium foil for 5-10 minutes, until thoroughly defrosted.
D2-1 Defrost  Poultry (initial temp -18° C)	0.9 - 1.8 kg (100 g) (see note on page 15)	<ul style="list-style-type: none"> • Place a plate upside down on the turntable and put the poultry breast side down on the plate. • When the oven stops and the audible signal sounds, turnover and shield the thin parts and warm spots with aluminium foil. • After defrosting, cover with aluminium foil and stand for 15-30 minutes until thoroughly defrosted. • Finally clean the poultry under running water.

EXPRESS COOK & EXPRESS DEFROST CHART



MENU NO.	WEIGHT (Increasing Unit) / UTENSILS	PROCEDURE
D2-2 Defrost  Chicken Legs (initial temp -18° C)	0.2 - 1.0 kg (50 g) (See note below for utensils)	<ul style="list-style-type: none"> Place the food on a plate in the centre of the turntable. When the oven stops and the audible signals sound, turn the food over, rearrange and separate. Shield the thin parts and warm spots with aluminium foil. After defrosting, wrap in aluminium foil for 10 - 15 minutes, until thoroughly defrosted.
D3-1 Defrost  Cake (initial temp -18° C)	0.1 - 1.4 kg (100 g) Flat dish	<ul style="list-style-type: none"> Remove all packaging from the cake. Place on a flat dish in the centre of the turntable. After defrosting, cut the cake into similar sized pieces. Keep space between each piece and let stand for 15 - 30 minutes until thoroughly defrosted.
D3-2 Defrost  Bread (initial temp -18° C)	0.1 - 1.0 kg (100 g) Flat dish	<ul style="list-style-type: none"> Distribute directly on a flat dish in the centre of the turntable. Only sliced bread is recommended for this programme. When the audible signal sounds rearrange, and remove defrosted slices. After defrosting separate all slices and distribute on a large plate. Cover the bread with aluminium foil and let stand for 5 - 10 minutes until thoroughly defrosted.

NOTE: Express Defrost

- 1 Steaks, Chops and Chicken legs should be frozen in one layer.
- 2 Minced meat should be frozen in the thin shape.
- 3 After turning over, shield the defrosted portions with small, flat pieces of aluminium foil.
- 4 The poultry should be processed immediately after defrosting.
- 5 For D1-1, D2-1 and D2-2 arrange the food in the oven as shown:

Chicken legs, Steaks and Chops.

Poultry

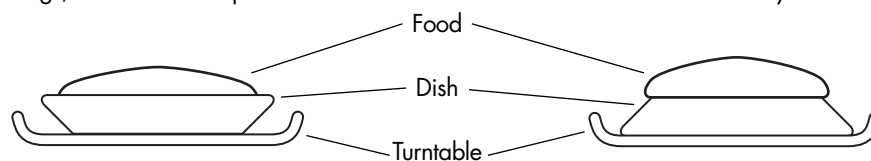



AUTO COOK OPERATION

AUTO COOK automatically works out the correct cooking mode and cooking time. You can choose from 8 **AUTO COOK** menus.

AUTOMATIK
PROGRAMME

What you need to know when using **AUTO COOK**:

1. Press the **AUTO COOK** key once, the display will appear as shown.
The menu can be chosen by pressing the **AUTO COOK** key until the desired menu number is displayed. See "**AUTO COOK** chart" below.
2. To set the weight press the **WEIGHT DECREASE/INCREASE** () key until the desired weight is displayed.
Enter the weight of the food only. Do not include the weight of the container.
For food weighing more or less than the weights/quantities given in the **AUTO COOK** chart, cook using manual operation.
3. To start cooking press **START/+ 1 min** key.

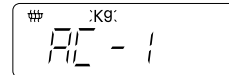

NOTES:

- The programmed cooking times are average times. If you want to alter the cooking times of **AUTO COOK**, use the **LESS** (▼) or **MORE** (▲) keys. For best results use the cooking chart instructions.
- When manipulation is required (eg: to stir) the oven will stop and the audible signal will sound, the display will show the necessary action. To continue cooking, press the **START/+ 1 min** key.
- The final temperature of the food will vary according to its initial temperature. Check food is piping hot after cooking. If necessary, you can extend the cooking time. Always refer to the cooking charts given in the separate cookery book.

Example:

To cook Gratin weighing 1.5 kg using auto cook AC-6.

1. Select the menu required by pressing the **AUTO COOK** key six times.
2. Press the **WEIGHT DECREASE/ INCREASE** key until the correct weight appears in the display.
3. Press the **START/+ 1 min** key once to begin cooking.

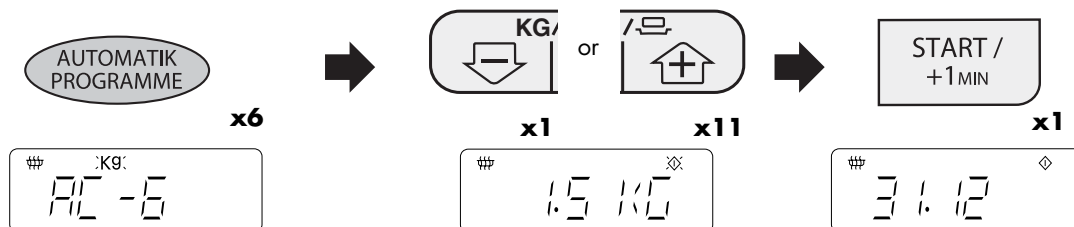







AUTO COOK CHART

MENU NO.	WEIGHT (Increasing Unit) / UTENSILS	PROCEDURE
AC-1 Beverages (initial temp 20° C)	1-6 cups (1 cup) 150 ml per cup	<ul style="list-style-type: none"> • Place the beverage off centre on the turntable. • After heating, stir and let stand for approx. 1 - 2 minutes. <p>NOTE: If initial beverage is (5° C ± 2° C) refrigerator temperature, cook manually.</p>
AC-2 Soups, Casseroles (initial temp 20° C)	1-4 cups (1 cup) 200 ml per cup Cup with plastic wrap/lid	<ul style="list-style-type: none"> • Cover with microwave plastic wrap or lid. • Place cups off centre on the turntable. • After cooking, stir and let stand for approx. 1 - 2 minutes.

AUTO COOK CHART



MENU NO.	WEIGHT (Increasing Unit) / UTENSILS	PROCEDURE							
AC-3 Fresh Vegetables (initial temp 20° C) e.g. Cauliflower, carrot, broccoli, fennel, leek, pepper, courgettes 	0.1 - 0.6 kg (100 g) Bowl and lid	<ul style="list-style-type: none"> • Cut into small pieces, eg. strips, cubes or slices. • Add the required amount of water (1tbsp per 100 g) and salt as desired. • Cover with lid. • When audible signal sounds, stir and recover. • After cooking, let the food stand for approx 2 minutes. 							
AC-4 Boiled Potatoes & Jacket Potatoes (initial temp 20° C) 	0.1 - 0.8 kg (100 g) Bowl & lid	Boiled Potatoes: Peel the potatoes and cut them into similar sized pieces. Jacket Potatoes: Choose potatoes of similar size and wash them. <ul style="list-style-type: none"> • Put the boiled or jacket potatoes into a bowl. • Add the required amount of water (per 100 g), approx 2 tbsp and a little salt. • Cover with a lid • When the oven stops and the audible signals sound, stir and re-cover. • After cooking, let the potatoes stand for 1-2 minutes. 							
AC-5 Rice (initial temp of Rice 20° C) 	0.1 - 0.3 kg (100 g) Bowl & lid	<ul style="list-style-type: none"> • Place in a big bowl and add water. • Cover with lid. • Place the dish in the centre of the turntable. • When the audible signal sounds, stir and recover, replace into the oven and press start. • When the audible signal sounds again, stir and recover, replace into the oven and press start. • Stand for 10 minutes after cooking. 							
<table border="1" style="width: 100%; text-align: center;"> <thead> <tr> <th>Rice</th> <th>Boiling water</th> </tr> </thead> <tbody> <tr> <td>100 g</td> <td>250 ml</td> </tr> <tr> <td>200 g</td> <td>450 ml</td> </tr> <tr> <td>300 g</td> <td>650 ml</td> </tr> </tbody> </table>	Rice		Boiling water	100 g	250 ml	200 g	450 ml	300 g	650 ml
Rice	Boiling water								
100 g	250 ml								
200 g	450 ml								
300 g	650 ml								
AC-6 Gratin 	0.5 - 1.5 kg (100 g) Shallow, oval gratin dish	<ul style="list-style-type: none"> • Prepare the gratin, referring to page 36 of the cookbook. • After cooking, let the food stand for approx. 5 - 10 minutes. 							
AC-7 Fish fillets with sauce (initial temp fish 5° C sauce 20° C) 	0.4 - 1.6 kg* (100 g) (fish: 0.2 - 0.8 kg, sauce: 0.2 - 0.8 kg) Flan dish & plastic wrap * Total weight of Fish and Sauce.	<ul style="list-style-type: none"> • Put the fish fillet in a flat flan dish with thin ends towards the centre. • Spread the prepared sauce on the fish fillet. • Cover with microwave plastic wrap. • After cooking let the food stand for approx. 2 minutes. For sauce recipes, see Page 18.							
AC-8 Jam (initial temp 20° C) 	0.5 - 1.5 kg* (100 g) 3.5l casserole dish * Total weight of fruit and jelly sugar.	<ul style="list-style-type: none"> • Follow quantity in recipes on page 19. • Defrost frozen fruits before cooking. • No cover. • When the audible signal sounds, stir. • When the audible signal sounds again, stir and mash. • After cooking, pot and seal. 							



RECIPES FOR AUTO COOK AC-7

Fish fillet with sauce - Cod fish fillet Provençal

Ingredients

20 g	butter
100 g	mushrooms cut in slices
1 clove	garlic (crushed)
50 g	spring onion
1 tin (825 g)	tinned tomatoes without juice, drain well
1 tsp	lemon juice
2 tbsps	tomato ketchup
1/2-1 tsp	dried basil, salt and pepper
800 g	cod fish fillet

Preparation

1. Cook butter, mushrooms, onions and garlic together in a flan dish for 3-4 mins. on 900 W.
2. Mix tomatoes, lemon juice, ketchup, basil, salt and pepper.
3. Place fish fillet on the vegetables and cover with sauce and some vegetables.
4. Cook on AUTO COOK AC-7 "Fish fillets with sauce".

Fishfillet with Leek and Cheese-sauce

Ingredients

50 g	butter
175 g	spring onion
1/2 tsp	dried Marjoram
40 g	flour
500 ml	milk
100 g	grated Gruyere, salt, pepper
1 tbsps	chopped parsley
800 g	fish fillet (e.g. coal fish)

Preparation

1. Put butter, onions and Marjoram in a casserole and heat for 3-4 mins on 900 W.
2. Stir in the flour and add the milk. Stir to a smooth sauce.
3. Cook for 3-4 mins on 900W uncovered.
4. Stir in the cheese, season to taste.
5. Place the fish fillet in a quiche dish and pour the sauce over it.
6. Cook on AUTO COOK AC-7 "Fish fillets with sauce".
7. After cooking take out the fish and stir the sauce well.

NOTE:

1. These indications are for 1.6 kg. If you want to cook less than 1.6 kg you have to adjust (reduce) the ingredients for the sauce and also the cooking time for the preparation of the sauce.
2. If you want to make the sauce thicker for cod fillet provençal or fish fillet with piquant sauce, remove the fish after cooking and stir in some sauce thickening powder (please follow manufacturer's instructions).

Fish fillet with Piquant sauce

Ingredients

1 tin (825 g)	canned tomatoes, drain
1 tin (280 g)	corn
2-3 tsp	chilli sauce
40 g	onion, finely chopped
3 tsp	red wine vinegar
1/4 tsp	mustard
1 spice	thyme
1 spice	cayenne pepper
800 g	fish fillet (e.g. rosefish)

Preparation

1. Mix ingredients for the sauce.
2. Place fish fillet (e.g. Rosefish fillet) in a quiche dish and spread the sauce on fish fillet.
3. Cook on AUTO COOK AC-7 "Fish fillets with sauce".

Fishfillet with Curry sauce

Ingredients

40 g	butter
30 g	chopped almonds
1-2 tbsps	curry
30 g	flour (wholemeal)
40 g	raisins
200 g	pineapple (small pieces)
125 ml	broth
125 ml	pineapple juice
150 g	sour cream
100 g	peas (frozen), salt, pepper
800 g	fish fillet (coal fish)

Preparation

1. Heat butter, almonds and curry covered for 1-2 mins on 900 W.
2. Add the flour and stir very well.
3. Add raisins, pineapple, pineapple juice, broth and cream, stirring continuously.
4. Cook covered for 2-3 mins. on 900 W and stir after cooking.
5. Add the peas and stir.
6. Season with salt and pepper.
7. Place the fish in a quiche dish and pour over the sauce.
8. Cook covered on AUTO COOK AC-7 "Fish fillets with sauce".

RECIPES FOR AUTO COOK AC-8



Kiwi - Banana Jam

Ingredients

- 525 g Kiwi
- 225 g Banana
- 250 g Jelly sugar
(preserving sugar with pectin,
1 sugar : 3 fruits)

Preparation

1. Peel kiwis and bananas and cut into small pieces.
2. Mix the fruits with preserving sugar with pectin and fill into an oval 3.5 l-glass form (pyrex).
3. Cook on **AUTO COOK AC-8** "Jam".
4. After cooking fill into well cleaned glasses and cover with twist-off-lid or with preserving film.

Raspberry Jam

Ingredients

- 750 g Raspberries
- 250 g Jelly sugar
(preserving sugar with pectin,
1 sugar : 3 fruits)

Preparation

1. Mix raspberries with preserving sugar with pectin and fill into an 3.5 l-glassform (pyrex).
2. Cook on **AUTO COOK AC-8** "Jam".
3. After cooking fill into well cleaned glasses and cover with twist-off-lid or with preserving film.

Nectarine Jam

Ingredients

- 667 g Nectarines
- 3 tbsp. Lemon juice
- 333 g Jelly sugar
(preserving sugar with pectin,
1 sugar : 2 fruits)
- 4 tbsp. Orange liqueur (for ex. Coitreau)

Preparation

1. Cut nectarines into small pieces.
2. Put them into an oval 3.5 l-glassform (pyrex).
3. Mix them with lemon juice and preserving sugar with pectin.
4. Cook on **AUTO COOK AC-8** "Jam".
5. After cooking add orange liqueur, fill into well cleaned glasses and cover with twist-off-lid or with preserving film.

Mixed Berries Jam

Ingredients

- 667 g Mixed berries (blackberry, blueberry, raspberry, currant, strawberry)
- 333 g Jelly sugar
(preserving sugar with pectin,
1 sugar : 2 fruits)

Preparation

1. Fill mixed berries and preserving sugar with pectin into an oval 3.5 l-glassform (pyrex) and mix them.
2. Cook on **AUTO COOK AC-8** "Jam".
3. After cooking fill into well cleaned glasses and cover with twist-off-lid or with preserving film.

NOTE:

1. Please follow the instructions in the AUTO COOK chart on page 17.
2. These instructions are for 1.0kg. If you want to cook other weights, adjust the ingredients.



CARE AND CLEANING

Caution

Do not use commercial oven cleaners, abrasive harsh cleaners or scouring pads on any part of your microwave oven.

Oven exterior

The outside of your oven can be easily cleaned with mild soap and water. Make sure that the soap is wiped off with a moist cloth, and dry the exterior with a soft towel.

Control panel

Open the door before cleaning to de-activate the control panel. Care should be taken in cleaning the control panel. Using a cloth dampened with water only, gently wipe the panel until it becomes clean. Avoid using excessive amounts of water. Do not use any sort of chemical or abrasive cleaner.

Oven Interior

1. For cleaning, wipe any spatters or spills with a soft damp cloth or sponge after each use while the oven is still warm. For heavier spills, use mild soap and wipe several times with a damp cloth until all residues are removed.
2. Make sure that mild soap or water do not penetrate the small vents in the walls which may cause damage to the oven.
3. Do not use spray type cleaners on the oven interior.

Turntable and Roller stay

Remove the turntable and roller stay from the oven. Wash the turntable and roller stay in mild soapy water. Dry with a soft cloth. Both the turntable and the roller stay are dishwasher safe.

Door

To remove all trace of dirt, regularly clean both sides of the door, the door seals and surfaces with a soft, damp cloth.



SERVICE CALL CHECK

Please check the following before calling for service.

1. Power Supply

Check the power plug is properly connected to a suitable wall outlet.

Check the line fuse/circuit breaker is functioning properly.

2. Place a cup of water (approx. 150 ml) in the oven and close the door securely.

Programme the oven for one minute on HIGH (900 W) power and start the oven.

Does the oven lamp come on?

YES _____ NO _____

Does the turntable rotate?

YES _____ NO _____

NOTE: The turntable turns in either direction.

Does the ventilation work?

YES _____ NO _____

(Place your hand over the ventilation openings and check for air flow.)

After 1 minute does the signal sound?

YES _____ NO _____

Does cooking in progress indicator go off?

YES _____ NO _____

Is the cup with water warm after the above operation?

YES _____ NO _____

If "NO" is the answer to any of the above questions, call your dealer or an authorised SHARP Service Agent and report the results of your check.

SPECIFICATIONS



AC Line Voltage	: 230 V, 50 Hz, single phase
Distribution line fuse/circuit breaker	: Minimum 10 A
AC Power required: Microwave	: 1.4 kW
Output power: Microwave	: 900 W (IEC 60705)
Microwave Frequency	: 2450 MHz
Outside Dimensions	: 520 mm(W) x 305 mm(H) x 413 mm(D)
Cavity Dimensions	: 342 mm(W) x 207 mm(H) x 368 mm(D)
Oven Capacity	: 26 litres
Turntable	: \varnothing 325 mm
Weight	: approx. 17 kg
Oven lamp	: 25 W/240-250 V

This equipment complies with the requirements of directives 89/336/EEC and 73/23/EEC as amended by 93/68/EEC.

As part of a policy of continuous improvement, we reserve the right to alter design and specifications without notice



WHAT ARE MICROWAVES?

WHAT ARE MICROWAVES?

Like radio and television waves, microwaves are electromagnetic waves.

Microwaves are produced by a magnetron inside the microwave oven, and these vibrate the molecules of water present in the food. The friction this causes produces heat, which ensures that the food is defrosted, heated, or cooked through.

The secret of the reduced cooking times is the fact that the microwaves penetrate the food from every direction. Energy is used to the full. In comparison, the energy from a conventional hob passes from the burner through the pan and so to the food. This method wastes a great deal of energy.

THE CHARACTERISTICS OF MICROWAVES.

Microwaves penetrate all non-metal objects made of glass, china, earthenware, plastic, wood or paper. This is why the microwaves never make these materials hot. Dishes become hot only because the food inside them is hot.

The food absorbs the microwaves and is heated.

Microwaves cannot pass through objects made of metal and so they are deflected. For this reason metal objects are not normally suitable for microwave cookery. There are exceptions where you can actually make use of the fact that the microwaves cannot pass through metal. If you cover food with aluminium foil at specific points while it is defrosting or cooking, you can prevent those parts from getting too warm, too hot, or overcooked. Please check out the advice given in the guide.



SUITABLE COOKWARE

GLASS AND CERAMIC GLASS



Heat-resistant glass utensils are very suitable. The cooking process can be observed from all sides. They must not, however, contain any metal (e.g. lead crystal), nor have a metallic overlay (e.g. gold edge, cobalt blue finish).

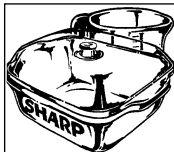

CERAMICS

Generally very suitable.

Ceramics must be glazed, since with unglazed ceramics moisture can get into the ceramic. Moisture causes the material to heat up and may make it shatter. If you are not certain whether your utensil is suitable for the microwave, carry out the utensil suitability test.

PORCELAIN

Very suitable. Ensure that the porcelain does not have a gold or silver overlay and that it does not contain any metal.

PLASTIC AND PAPER UTENSILS

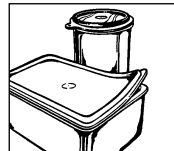

Heat resistant plastic utensils which are suitable for use in the microwave can be used to thaw, heat and cook food. Follow the manufacturers recommendations.

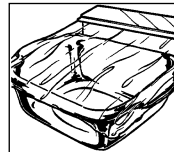

Heat-resistant paper made for use in a microwave oven is also suitable. Follow the manufacturers recommendations.

SUITABLE COOKWARE



MICROWAVE FOIL

This, or heat-resistant foil, is very suitable for covering or wrapping. Please follow the manufacturer's recommendations.

ROASTING BAGS

Can be used in a microwave oven. Metal clips are not suitable for fastening them since the roasting bag foil might melt. Fasten the roasting bag with string and pierce it several times with a fork. Non heat-resistant food wraps are not recommended for use in a microwave oven.

BROWNING DISH

A special microwave dish made from ceramic glass with a metal alloy base, which allows food to be browned.

When using the browning dish a suitable insulator, e.g. a porcelain plate, must be placed between the turntable and the browning dish. Be careful to adhere exactly to the pre-heating time given in the manufacturer's instructions. Excessive pre-heating can damage the turntable and the turntable stand or can trigger the safety-device which will switch off the oven.

METAL

Generally speaking, metal should not be used, since microwaves do not pass through metal and therefore cannot reach the food. There are, however, exceptions: small strips of aluminium foil may be used to cover certain parts of the food, so that these do not thaw too quickly or begin to cook (e.g. chicken wings). Small metal skewers and aluminium containers (e.g. of ready-cooked meals) can be used.

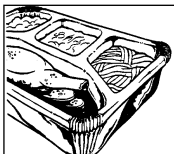

They must, however, be small in relation to the food, e.g. aluminium containers must be at least $\frac{2}{3}$ to $\frac{3}{4}$ filled with food. It

is recommended that you transfer the food into a dish suitable for use in the microwave. When using aluminium containers or other metal utensils there must be a gap of approx. 2 cms between them and the walls of the cooking area, otherwise the walls could be damaged by possible arcing.

NO UTENSIL SHOULD HAVE A METAL OVERLAY metal parts such as screws, bands or handles.

UTENSIL SUITABILITY TEST

If you are not sure whether your utensil is suitable for use in your microwave oven, carry out the following test: Place the utensil into the oven. Place a glass container filled with 150 ml of water on or next to the utensil. Switch on the oven at 900 W power for 1 to 2 minutes. If the utensil stays cool or just warm to the touch, it is suitable. Do not use this test on a plastic utensil. It could melt.

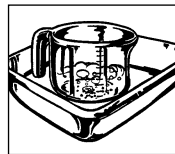



TIPS AND HINTS

BEFORE YOU START...

To make it as easy as possible to use the microwave oven, we have put together a few hints and tips for you.

Only switch on the oven when the food is already inside.

SETTING THE COOKING TIME

Defrosting, re-heating and cooking times are generally much shorter than in a conventional oven or hob. So you will need to consult this book for the recommended cooking times. It is better to set shorter rather than longer cooking times. Always test the food after the cooking time has elapsed. It is better to then continue cooking it for a little longer, than to have overcooked food.

STARTING TEMPERATURE

Defrosting, re-heating and cooking times depend on the temperature of the food when you start. For example, deep-frozen and refrigerated food will need longer than food that is at room temperature. Standard storage temperatures of food are assumed for re-heating and cooking times (refrigerator temperature of 5° C, room temperature of approximately 20° C). For defrosting food a starting temperature of approximately -18° C is assumed.

Cook **popcorn** only in special microwave safe containers. Refer exactly to the manufacturer's instructions. Do not use a normal paper or glass container.



Do not cook **eggs** in their unbroken shells. Pressure builds up inside the shell and this may result in the egg exploding. Prick the yolk before you cook it.

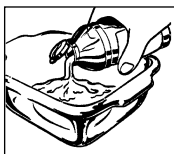

Do not heat **oil or fat** for deep-frying inside the microwave oven. It is impossible to control the temperature of the oil and it may suddenly splash out of the pan.

Do not heat **sealed containers** such as jars or tins. The pressure inside the container could cause the container to explode. (The exception is when you are making preserves).

ALL INDICATED COOKING TIMES...

are guidelines only. Cooking times may vary depending on starting temperature, the weight and composition (water, fat content, etc) of the food.

SALT, HERBS AND SPICES

Food cooked in the microwave oven retains its taste better than with conventional cooking methods. Use salt sparingly and as a rule only add salt after the food has cooked. Salt binds liquids and dries out the surface of food. Herbs and spices can be used as normal.

TESTING THE FOOD

You can test whether food is cooked in the same way as conventional cookery.

- Using a food thermometer. After cooking or re-heating all foods have a certain internal temperature. You can use a food thermometer to test whether the food is hot enough, or 'done'.
- Using a fork. Test fish with a fork. If the flesh is not transparent and comes off the bone easily, it is done. If it is overcooked, it will be brittle and dry.
- Wooden skewer. Test cakes and bread by sticking in a wooden skewer. If the skewer comes out clean and dry, the food is ready.

WORKING OUT COOKING TIMES USING THE FOOD THERMOMETER

After it has cooked, every drink or item of food has a certain internal temperature. When it is reached the cooking can be stopped, and the result will be good. You can test the internal temperature with a food thermometer. The temperature chart on the next page gives most of the important temperatures.

TIPS AND HINTS

**CHART: USING A FOOD THERMOMETER
TO DEFINE COOKING TIMES**

Drink/food items	Internal temperature at the end of cooking time	Internal temperature after 10-15 mins standing time
Heating drinks (coffee, water, tea, etc)	65-75° C	
Heating milk	75-80° C	
Heating soup	75-80° C	
Heating stews	75-80° C	
Poultry	80-85° C	85-90° C
Lamb		
Rare	70° C	70-75° C
Well roasted	75-80° C	80-85° C
Roast beef		
Rare	50-55° C	55-60° C
Medium done	60-65° C	65-70° C
Well done	75-80° C	80-85° C
Pork, veal	80-85° C	80-85° C

ADDING WATER

Vegetables and other foods containing a lot of water can be cooked in their own juices or by adding just a small amount of water. This will retain many vitamins and minerals in the food.

FOOD WITH SKIN OR PEEL

Pierce foods such as sausages, chickens, chicken legs, potatoes in their skins, tomatoes, egg yolk, etc with a wooden skewer. This allows the steam to escape and the food won't explode.

FATTY FOODS

Food 'marbled' with fat or with layers of fat cook faster than lean meat. You should therefore cover these parts with some aluminium foil, and place the food fatty side downward.

BLANCHING VEGETABLES

Before they are frozen vegetables should be blanched. This is the best way of retaining the quality and flavour.

How to blanch vegetables:

Wash and chop the vegetable, place 250g of the vegetable in a bowl with 275ml of water, cover and heat for 3-5 minutes.

Plunge into cold water immediately after the

blanching process to prevent further cooking, and then allow it to drain. Pack and freeze the vegetable in airtight containers.

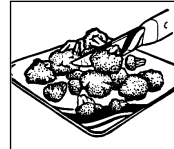
PRESERVING FRUIT AND VEGETABLES

Preserving fruit and vegetables using the microwave is a quick and easy process. You can buy preserving jars, seals and preserving jar clamps specially designed for microwave use. Precise instructions are provided by the manufacturers of these items.

SMALL AND LARGE QUANTITIES

Microwave cooking times depend directly upon the amount of food you want to defrost, re-heat or cook, i.e. small portions cook faster than big ones.

The rule of thumb is:

TWICE AS MUCH = ALMOST TWICE AS LONG

HALF AS MUCH = HALF AS LONG

TALL CONTAINERS, FLAT DISHES

Both types of container have the same capacity but cooking times are longer for tall containers than

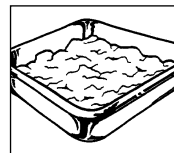

for flat ones. Therefore it is preferable to use dishes that are as flat as possible, with the largest possible flat surface.

Only use tall containers for foods that are likely to boil over, e.g.

noodles, rice, milk etc.

ROUND AND OVAL DISHES

Food cooks more evenly in round and oval dishes than in rectangular ones, because the microwave energy concentrates into the corners of rectangular dishes and the food there may get overcooked.



TIPS AND HINTS

COVERING THE FOOD

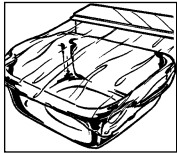

By covering the food as it cooks moisture is retained and cooking time is reduced. Use a lid, microwave film, or cover. Do not cover food that should have a crispy surface, such as roast meat or chicken. As a rule if you would cover it in a conventional oven, cover it in the microwave. If you would cook it in the oven without a cover, you can cook it without a cover in the microwave.

IRREGULAR SHAPED FOOD

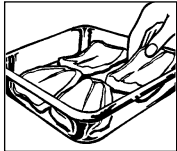

Place the thicker, more compacted end of the food pointing towards the outside. Place vegetables (such as broccoli) with the stalks pointing outward.

STIRRING

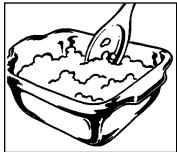

You need to stir the food because the microwaves heat the outer areas first. Stirring the food balances the temperature and the food heats evenly.

ARRANGING

Arrange individual portions (pudding moulds, cups or baked potatoes) in a circle on the turntable. Leave space between the portions for the microwave energy to penetrate from all sides.

TURNING

Turn medium sized portions, such as burgers and steaks, once during cooking, to reduce cooking time. Large items such as roasts and chickens must be turned because they receive more microwave energy on the uppermost side and could dry out if not turned.

STANDING TIME

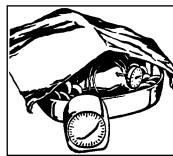

One of the most important rules of microwave cooking is standing time. Almost all foods that are defrosted, heated or cooked in a microwave oven require standing time. This may be fairly short or quite long. During this time the temperature is balanced and the liquids inside the food are evenly distributed.

BROWNING AGENTS

After more than 15 minutes cooking time food acquires a brownness, although this is not comparable to the deep brownness and crispness obtained through conventional cooking. In order to obtain an appetising brown colour you can use browning agents. For the most part they simultaneously act as seasoning agents. In the following table you will find some suggestions for substances you can use as browning agents and some of the uses to which you might put them.

BROWNING AGENT	DISH	METHOD
Melted butter and dried paprika	Poultry	Coat the poultry with the butter/paprika mixture
Dried paprika	Oven baked dishes - Cheese toasties	Dust with paprika
Soya sauce	Meat and poultry	Coat with the sauce
Barbecue and Worcestershire sauce, Gravy	Roasts, Rissoles, Small roasted items	Coat with the sauce
Rendered down bacon fat or dried onions	Oven baked dishes, toasted items, soups, stews	Sprinkle pieces of bacon or dried onions on top
Cocoa, chocolate flakes, brown icing, honey and marmalade	Cakes and desserts	Sprinkle pieces on top of cakes & desserts or use to glaze

HEATING



- Ready-prepared meals in aluminium containers should be removed from the aluminium container and heated on a plate or in a dish.
- Remove the lids from firmly closed containers.
- Food should be covered with microwave foil, a plate or cover (obtainable from stores), so that the surface does not dry out. Drinks need not be covered.
- When boiling liquids such as water, coffee, tea or milk, place a glass stirrer in the container.
- If possible, stir large quantities from time to time, to ensure that the temperature is evenly distributed.
- The times are for food at a room temperature of 20° C. The heating time for food stored in a refrigerator should be increased slightly.
- After heating allow the food to stand for 1-2 minutes, so that the temperature inside the food can be evenly distributed (standing time).
- The times given are guidelines which can be varied according to the initial temperature, weight, water content, fat content or the result which you want to achieve.

DEFROSTING



Your microwave is ideal for thawing. Thawing times are usually considerably shorter than in traditional methods. Here are a few tips. Take the frozen item out of its packaging and place on a plate for thawing.

BOXES AND CONTAINERS

Boxes and containers suitable for microwaves are particularly good for thawing and heating food, since they can withstand temperatures in a deep freeze (down to approx. -40° C) as well as being heat resistant (up to approx. 220° C). You can therefore use the same container to freeze, thaw, heat and even cook the food, without having to transfer it.

COVERING

Cover thin parts with small strips of aluminium foil before thawing. Thawed or warm parts should likewise be covered with aluminium strips during thawing. This stops the thin parts becoming too hot while thicker parts are still frozen.



CORRECT SETTING

It is better to choose a setting which is too low rather than one which is too high. By doing so you will ensure that the food thaws evenly. If the microwave setting is too high, the surface of the food will already have begun to cook while the inside is still frozen.

TURNING/STIRRING

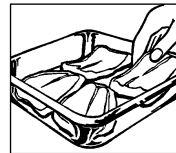

Almost all foods have to be turned or stirred from time to time. As early as possible, separate parts which are stuck together and re-arrange them.

SMALL AMOUNTS

Thaw more quickly and evenly than large ones. We recommend that you thaw portions which are as small as possible. By doing so you will be able to prepare whole menus quickly and easily.

FOODS REQUIRING CAREFUL HANDLING

Foods such as gateaux, cream, cheese and bread should only be partially thawed and then left to thaw completely at room temperature. By doing so you will avoid the outer areas becoming too hot whilst the inside is still frozen.

STANDING TIME

This is particularly important after thawing food, as the thawing process continues during this period. In the thawing table you will find the standing times for various foods. Thick, dense foods require a longer standing time than thinner foods or foods of a porous nature. If the food has not thawed sufficiently, you may continue thawing it in the microwave or lengthen the standing time accordingly. At the end of the standing time you should process the food as soon as possible and not re-freeze it.



COOKING FRESH VEGETABLES

- When buying vegetables, try to ensure that, as far as possible, they are of similar size. This is particularly important when you want to cook the vegetables whole (e.g. boiled potatoes).
- Wash the vegetables before preparing them, clean them and only then weigh the required quantity for the recipe and chop them up.
- Season them as you would normally, but as a rule only add salt after cooking.
- Add about 5 tbsps of water for 500 g of vegetables. Vegetables which are high in fibre require a little more water. You will find information in the table (see page 31).
- Vegetables are usually cooked in a dish with a lid. Those with a high moisture content, e.g. onions or boiled potatoes, can be cooked in microwave foil without adding water.
- After half the cooking time has elapsed vegetables should be stirred or turned over.
- After cooking allow the vegetables to stand for approx. 2 minutes, so that the temperature disperses evenly (standing time).
- The cooking times given are guidelines and depend upon the weight, initial temperature and condition of the type of vegetables in question. The fresher the vegetables, the shorter the cooking time.



COOKING MEAT, FISH AND POULTRY

- When buying food items, try to ensure that, as far as possible, they are of similar size. This will ensure that they are cooked properly.
- Before preparation wash meat, fish and poultry thoroughly under cold running water and pat them dry with kitchen paper. Then continue as normal.
- Beef should be well hung and have little gristle.
- Even though the pieces may be of a similar size, cooking results may vary. This is due, amongst other things, to the kind of food, variations in the fat and moisture content as well as the temperature before cooking.
- After the food has been cooking for 15 minutes it acquires a natural brownness, which may be enhanced by the use of a browning agent. If, in addition, you would like the surface to be crisp you should either use the browning dish or sear the food on your cooker and finish cooking it in your microwave. By doing this you will simultaneously obtain a brown base for making a sauce.
- Turn large pieces of meat, fish or poultry half way through the cooking time, so that they are cooked evenly from all sides.
- After cooking, cover roasts with aluminium foil and allow them to stand for approx. 10 minutes (standing time). During this period the roast carries on cooking and the liquid is evenly distributed, so that when it is carved a minimum amount of juice is lost.



COOKING AND DEFROSTING

Deep-frozen dishes can be thawed and cooked at the same time in one process in your microwave. You will find some examples in the table. Do take note, however, of the general advice given on "heating" and "thawing" food. Please refer to the

manufacturer's instructions on the packaging when preparing deep-frozen dishes. These usually contain precise cooking times and offer advice on preparation.

TABLES



ABBREVIATIONS USED

tbsp = tablespoon	g = gram	Sach. = sachet	MW = microwave
tsp = teaspoon	l = litre	DFC = dry fat content	MWO = microwave oven
l.p. = large pinch	ml = millilitre	dm = diameter	min = minutes
s.p. = small pinch	cm = centimetre	kg = kilogram	sec = seconds
Cup = cupful	DF = deep frozen		

TABLE : HEATING FOOD AND DRINK

Food / Drink	Quantity -g/ml-	Power -Level-	Time -Min-	Hints
Coffee, 1 cup	150	900 W	approx. 1	do not cover
Milk, 1 cup	150	900 W	approx. 1	do not cover
Water, 1 cup	150	900 W	approx. 2	do not cover, bring to the boil
6 cups	900	900 W	8-10	do not cover, bring to the boil
1 bowl	1000	900 W	9-11	do not cover, bring to the boil
Platters (Vegetables, meat and trimmings)	400	900 W	3-5	sprinkle some water onto the sauce, cover stir half way through the heating time
Stew	200	900 W	1 ¹ / ₂ -2	cover, stir after heating
Clear soup	200	900 W	1-1 ¹ / ₂	cover, stir after heating
Cream soup	200	900 W	1 ¹ / ₂ -2 ¹ / ₂	cover, stir after heating
Vegetables	200	900 W	2-3	if necessary add some water, cover
	500	900 W	3-5	stir half way through the heating time
Garnishes	200	900 W	2-3	sprinkle with water, cover and stir from time to time
	500	900 W	4-5	
Meat, 1 slice*	200	900 W	3-4	thinly spread sauce over the top, cover
Fish fillet*	200	900 W	3-5	cover
Sausages, 2	180	630 W	1-1 ¹ / ₂	pierce the skin several times
Cake, 1 piece	150	450 W	1 ¹ / ₂ -1	place on a cake stand
Baby food, 1 glass	190	450 W	1 ¹ / ₂ -1	remove the lid, after heating stir well and test the temperature
Melting butter or margarine*	50	900 W	1-1 ¹ / ₂	
Melting chocolate	100	450 W	3-4	stir from time to time
Dissolving six sheets of gelatin	10	450 W	approx. 1 ¹ / ₂	dip into water, squeeze thoroughly and place in a soup bowl, stir from time to time
Glazing for a tart of 1/4 l of liquid	10	450 W	3-5	mix the sugar in 250ml of liquid, cover, stir well during and after heating

* Refrigerator temperature

TABLE: COOKING MEAT, FISH AND POULTRY

Food	Quantity -g-	Power -Level-	Time -Min-	Hints	Standing time -Min-
Roasts	500	630 W	17-22	season to taste, place in a shallow flan dish	10
(pork,	1000	630 W	34-38	turn over halfway through cooking time	10
veal, lamb)	1500	630 W	53-58		10
Roast beef (medium)	1000	630 W	20-24	season to taste, place in a quiche dish,	10
	1500	630 W	27-31	turn over halfway through cooking time	10
Minced meat	1000	900 W	21-24	prepare the minced meat mixture (half pork / half beef) place in a shallow casserole dish	10
Fish fillet	200	900 W	4-6	season to taste, place on a plate, cover	3
Chicken	1200	630 W	29-32	season to taste, place in a casserole dish, turn halfway through cooking time	3
Chicken legs	200	900 W	3-6	season to taste, place on a plate, cover	3



TABLES

TABLE: COOKING MEAT, FISH AND POULTRY

Food	Quantity -g-	Power -Level-	Time -Min-	Hints	Standing time -Min-
Roasts	1500	90 W	55-60	Place on an upturned plate,	30 - 90
(pork, beef,	1000	90 W	38-42	turn halfway through	30 - 90
veal, lamb)	500	90 W	20-25		30 - 90
Steaks, escalopes, chops, liver	200	270 W	2-4	Turn halfway through	10 - 15
Goulash	500	270 W	8-9	Break up and stir halfway through	10 - 15
Ham or large sausage as one piece	200	270 W	2-3	Thaw slightly only	5
Cold cuts	200	270 W	2-4	Each minute, take off the outside slices	5
Sausages 8	600	270 W	6-8	Place alongside one another,	5 - 10
4	300	270 W	3-5	turn halfway through	5 - 10
Duck/turkey	1500	90 W	42-46	Place on an upturned plate, turn halfway through	30 - 90
Chicken	1200	270 W	18-20	Place on an upturned plate, turn halfway through	30 - 90
	1000	270 W	13-15		30 - 90
Chicken legs	1000	270 W	13-15	Turn halfway through	30 - 90
	200	270 W	3-4		10 - 15
Chicken breast	450	270 W	7-9	Turn halfway through	30 - 90
Fish in portions	800	270 W	12-13	Turn halfway through	10 - 15
Fish fillet	400	270 W	5-7	Turn halfway through	5 - 10
Crab	300	270 W	6-8	Turn halfway through, take away defrosted parts	30
Rolls, 2	80	270 W	1-1 ¹ / ₂	Thaw only	-
Sliced bread (for toasting) in slices	250	270 W	2-3	Place alongside one another, thaw only	5
White loaf, whole	500	270 W	3-5	Turn halfway through (ice particles remain)	30
Whole wheat loaf, sliced	250	270 W	2-3	Place slices alongside one another, thaw only	5
Bread made from wheat and rye flour	1000	270 W	8-10	Turn halfway through (ice particles remain)	30
Cakes, 1 piece	150	270 W	1-3	Place on a cake tray	5
Fruit flan, 1 piece	150	270 W	2-3	Place on a cake tray	10
Gateaux, 1 piece		270 W	Approx. 1	Place on a cake tray	5
Whole Gateaux (25 cm Ø)		270 W	9-11	Place on a cake tray	60
Butter	250	270 W	1-3	Thaw only	5
Cream	200	270 W	2+2	Remove lid, after 2 minutes pour into a bowl and continue to defrost	5 - 10
Cheese slices	200	270 W	1-2	Thaw only	10
Soft fruit: Strawberries Raspberries, Cherries, Plums	250	270 W	3-5	Position evenly next to each other, turn halfway through	5

Times given in this chart are guidelines only and may vary according to the starting temperature of the frozen food, its composition, and its weight.

TABLE : DEFROSTING AND COOKING

Food	Weight -g-	Power -Level-	Time -Min-	Added water -tbsps/ml-	Hints	Standing time -Min-
Fish fillet	300	900 W	9-11	-	cover	1-2
Trout, 1 fish	250	900 W	6-8	-	cover	1-2
Platter	400	900 W	8-10	-	cover, stir after 6 minutes	2
Leaf spinach	300	900 W	7-10	-	cover, stir once or twice during cooking	2
Broccoli	300	900 W	6-8	3-5 tbsps	cover, stir halfway through cooking time	2
Peas	300	900 W	6-8	3-5 tbsps	cover, stir halfway through cooking time	2
Kohlrabi	300	900 W	7-8	3-5 tbsps	cover, stir halfway through cooking time	2
Mixed vegetables	500	900 W	9-11	3-5 tbsps	cover, stir halfway through cooking time	2
Brussels sprouts	300	900 W	6-8	3-5 tbsps	cover, stir halfway through cooking time	2
Red cabbage	450	900 W	10-12	3-5 tbsps	cover, stir halfway through cooking time	2

TABLES



TABLE : COOKING FRESH VEGETABLES

Vegetable	Weight -g-	Power -Level-	Time -Min-	Hints	Added Water -tbsps/ml-
Artichokes	300	900 W	5-7	remove the stalk, cover	3-4 tbsps
Leaf Spinach	300	900 W	4-5	wash, dry well, cover, stir once or twice during cooking	-
Cauliflower	800	900 W	10-12	1 whole head, cover, divide into florets	5-6 tbsps
	500	900 W	6-8	stir during cooking	4-5 tbsps
Broccoli	500	900 W	6-8	divide into florets, cover, stir occasionally during cooking	4-5 tbsps
Mushrooms	500	900 W	6-8	whole heads, cover, stir occasionally during cooking	-
Chinese leaves	300	900 W	5-7	cut into strips, cover, stir occasionally during cooking	4-5 tbsps
Peas	500	900 W	6-8	cover, stir occasionally during cooking	4-5 tbsps
Fennel	500	900 W	6-8	cut into quarters, cover, stir occasionally during cooking	4-5 tbsps
Onions	250	900 W	4-5	whole, cook in microwave foil	-
Kohlrabi	500	900 W	7-9	dice, cover, stir occasionally during cooking	50 ml
Carrots	500	900 W	7-9	cut into rings, cover, stir occasionally during cooking	4-5 tbsps
Green peppers	500	900 W	6-8	cut into strips, cover, stir once or twice during cooking	4-5 tbsps
Jacket potatoes	500	900 W	6-8	cover, stir occasionally during cooking	4-5 tbsps
Leeks	500	900 W	7-9	cut into rings, cover, stir occasionally during cooking	4-5 tbsps
Red cabbage	500	900 W	15-17	cut into strips, stir once or twice during cooking	50 ml
Brussels sprouts	500	900 W	7-9	whole sprouts, cover, stir occasionally during cooking	50 ml
Boiled potatoes (salted)	500	900 W	7-9	cut into large pieces of a similar size, add a little salt, cover, stir occasionally during cooking	150 ml
Celery	500	900 W	7-9	dice finely, cover, stir occasionally during cooking	50 ml
White cabbage	500	900 W	15-17	cut into strips, cover, stir occasionally during cooking	50 ml
Courgettes	500	900 W	6-8	slice, cover, stir occasionally during cooking	4-5 tbsps

RECIPES

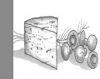

ADAPTING RECIPES FOR THE MICROWAVE OVEN

If you would like to adapt your favourite recipes for the microwave, you should take note of the following:

Shorten cooking times by a third to a half. Follow the example of the recipes in this cookery book.

Foods which have a high moisture content such as meat, fish, poultry, vegetables, fruit, stews and soups can be prepared in your microwave without any difficulty. Foods which have little moisture, such as platters of food, should have the surface moistened prior to heating or cooking.

The amount of liquid to be added to raw foods, which are to be braised, should be reduced to about two thirds of the quantity in the original recipe. If necessary, add more liquid during cooking.

The amount of fat to be added can be reduced considerably. A small amount of butter, margarine or oil is sufficient to flavour food. For this reason your microwave is excellent for preparing low-fat foods as part of a diet.

HOW TO USE RECIPES

- All the recipes in this cookery book are calculated on the basis of 4 servings - unless otherwise stated.
- Recommendations relating to suitable utensils and the total cooking times are given at the beginning of every recipe.
- As a rule the quantities shown are assumed to be wholly consumable, unless specifically indicated otherwise.
- When eggs are given in the recipes they are assumed to have a weight of approx. 55 g (grade M).



SOUPS

Spain

AVOCADO CREAM SOUP

Sopa de aguacates

Total cooking time: approx. 11-13 minutes

Utensil: dish with lid (2 l capacity)

Ingredients

- 3 avocados (600 g of flesh)
- lemon juice
- 700 ml meat stock
- 70 ml cream
- salt & pepper

1. Peel the soft, ripe avocados, remove the stones, cut the flesh into pieces and purée. Save two thin slices to decorate each portion and sprinkle with lemon juice.
2. Put the meat stock, avocados and cream into a dish, season with salt and pepper and cook with the lid on. Stir occasionally.
11-13 Min. 900 W
3. Stir the soup until it is creamy and decorate with the saved avocado slices. After cooking allow the soup to stand for approx. 5 minutes.

Sweden

CRAB SOUP

Kräftsoppa

Total cooking time: approx. 11-15 minutes

Utensil: bowl with lid (2 l capacity)

Ingredients

- 1 onion (50 g), chopped finely
- 50 g sliced carrots
- 3 tbsp butter or margarine (30 g)
- 500 ml meat stock
- 100 ml white wine
- 100 ml Madeira wine
- 200 g Tinned crab meat
- 1/2 bay leaf
- 3 white peppercorns
- thyme
- 3 tbsp flour (30 g)
- 100 ml cream

1. Place the vegetables into the bowl with the fat (2 tbsp), cover, and heat.
2-3 Min. 900 W
2. Add the meat stock, the wine, crabmeat, and seasoning to the vegetables. Cover and cook.
7-9 Min. 450 W
3. Take out the pepper corns and the bay leaf. Mix the flour with a little cold water and stir into the soup. Add the cream, stir well, and heat.
2-3 Min. 900 W
4. Stir the soup and allow to stand for about 5 minutes. Add the butter (1 tbsp) just before serving.

Switzerland

BARLEY SOUP

Bündner Gerstensuppe

Total cooking time approx. 27-34 minutes

Utensil: bowl with lid (3 l capacity)

Ingredients

- 2 tbsp butter or margarine (20 g)
- 1 onion (50 g), finely chopped
- 1-2 carrots (130 g) sliced
- 15 g celery, roughly chopped
- 1 leek (130 g), cut into rings
- 3 white cabbage leaves (100 g), in strips
- 200 g veal bones
- 50 g streaky bacon, cut into strips
- 50 g barley corn
- 700 ml meat stock
- pepper
- 4 Frankfurters (300 g)

1. Place the butter and chopped onion into the bowl, cover and braise.
approx. **1-2 Min. 900 W**
2. Add the vegetables to the bowl. Add the bones, the streaky bacon and the barley, and fill the bowl with the meat stock. Season with pepper, cover and cook.
 1. **9-11 Min. 900 W**
 2. **17-21 Min. 450 W**
3. Chop the frankfurters into small pieces and heat with the rest of the soup for the last five minutes.
4. Allow to stand for about 5 minutes after it has cooked. Take the bones out just before you serve the soup.

MEAT, FISH AND POULTRY



Austria

ROAST CHICKEN WITH STUFFING

Gefülltes Brathendl 2 Portions

Total cooking time: approx. 36-40 minutes

Utensils: bowl (2 l capacity), kitchen twine

Ingredients

- 1 Chicken (1000 g)
- salt
- rubbed rosemary
- rubbed marjoram
- 1 stale bread roll (white bread, 40 g)
- 1 bunch of parsley, chopped finely (10 g)
- pinch nutmeg
- 2 tbsps butter or margarine (20 g)
- 1 yolk of egg
- 3 tbsps butter or margarine (30g)
- 1 tbsp paprika pepper
- 1 tbsp butter or margarine to grease the dish

1. Wash the chicken, dab dry with kitchen towel and season with salt, rosemary and marjoram.
2. To make the stuffing, soak the roll for about 10 minutes in cold water, then press the water out. Mix in the salt, parsley, nutmeg butter and egg yolk and stuff the chicken with the mixture. Tie up the opening with ties or butcher's twine.
3. Heat the butter (30 g).
approx. **1 Min. ☼ 900 W**
Stir the paprika pepper and the salt into the butter, and drizzle the mixture over the chicken.
4. Place the chicken in the greased bowl and cook without lid. Turn halfway through.
35-39 Min. ☼ 630 W
Allow the chicken to stand for about 3 minutes after cooking.

Italy

QUAILS IN CHEESE AND HERB SAUCE

Quaglie in salsa vellutata

Total cooking time: approx. 27-33 minutes

Utensils: kitchen twine or thick thread

Flat round dish (diameter approx. 22 cm)

Bowl with lid (1 l capacity)

Ingredients

- 4 quails (600 g)
- salt & pepper
- 200 g streaky bacon, sliced thinly
- 1 tsp butter or margarine to grease the dish
- 1 tsp fresh parsley for each quail
- sage
- rosemary
- basil, chopped finely
- 150 ml port
- 250 ml meat stock
- 2 tbsps butter or margarine (20 g)
- 2 tbsps flour (20 g)
- 50 g grated Emmental cheese

1. Wash the quails and carefully dab them dry. Season with salt and pepper inside and out, wrap bacon around each bird, and tie up tightly with the twine.
2. Grease the dish, place the quails in the dish and cook. Turn over once halfway through.
10-12 Min. ☼ 900 W
3. Chop the herbs very fine, sprinkle over the quails, and pour the port over the top. Continue to cook the quails.
13-15 Min. ☼ 630 W
Take the quails out of the roasting sauce.
4. To make the sauce, heat the meat stock in the covered bowl.
2-3 Min. ☼ 900 W
Blend the butter with the flour, stir into the liquid, allow to boil, and cook. Stir once halfway through.
1-2 Min. ☼ 900 W
5. Stir the cheese into the sauce. Add the cheese sauce to the sauce, stir everything together well, and reheat.
approx. **1 Min. ☼ 900 W**
6. Pour the sauce over the quails and serve.

ENGLISH



MEAT, FISH AND POULTRY

Holland

MINCE AND ONIONS

Gehacktschotel

Total cooking time: approx. 20-23 minutes

Utensil: bowl with cover (2 l capacity)

Ingredients

- 500 g minced meat (half pork, half beef)
- 3 onions (150 g), finely chopped
- 1 egg
- 50 g white breadcrumbs
- salt
- pepper
- 350 ml meat stock
- 70 g tomato purée
- 2 potatoes (200 g), diced
- 2 carrots (200 g), diced
- 2 tbsps chopped parsley

Germany

SPICY TURKEY FRICASSEE

Pikante Putenpfanne

2 servings

Total cooking time: approx. 20-25 minutes

Utensil: flat, oval dish with a lid (about 26 cm long)

Ingredients

- 1 cup of long grain rice, parboiled (120 g)
- 1 sachet of saffron (containing the whole stigma)
- 1 tsp butter or margarine to grease the dish
- 1 onion (50 g), sliced
- 1 red pepper (100 g), cut into strips
- 1 small leek (100 g), cut into strips
- 300 g turkey breast, diced
- pepper
- paprika pepper
- 2 tbsps butter or margarine (20 g)
- 2 cups meat stock (300 ml)

Switzerland

ZÜRICH VEAL IN CREAM

Züricher Geschnetzeltes

Total cooking time: approx. 9-14 minutes

Utensil: dish with lid (2 l capacity)

Ingredients

- 600 g veal fillet
- 1 tbsp butter or margarine
- 1 onion (50 g), finely chopped
- 100 ml white wine
- Seasoned gravy browning, for approx. 1/2 l
- 300 ml cream
- 1 tbsp parsley, chopped

1. Mix together the minced meat, the chopped onion, the egg and the breadcrumbs to form a dough, knead, and season with salt and pepper. Place the meat dough into the bowl.
2. Mix the meat stock with the tomato purée.
3. Place the potatoes and carrots, with the liquid over the minced meat, mix it up well, cover and cook. Stir once halfway through.
20-23 Min. ## 900 W
Stir the mince once again, and allow it to stand for about 5 minutes. Sprinkle with parsley and serve.

1. Mix the rice with the saffron stigma and place in the greased dish. Mix in the onion slices, strips of pepper and leek and the diced turkey breast and season. Stack them on top of the rice. Dot with butter.
2. Pour the stock over the dish, cover and cook.
 1. **4-6 Min. ## 900 W**
 2. **16-19 Min. ## 270 W**
 Allow the turkey fricassee to stand for about 5 minutes after cooking.

1. Cut the fillet into finger-width strips.
2. Grease the dish all over with the butter. Put the onion and the meat into the dish, cover and cook. Stir once during cooking.
6-9 Min. ## 900 W
3. Add the white wine, gravy browning and cream, stir, cover and continue cooking. Stir occasionally.
3-5 Min. ## 900 W
4. Test the veal, stir the mixture once more and allow to stand for approx. 5 minutes. Serve garnished with parsley.

MEAT, FISH AND POULTRY



Spain

STUFFED HAM

Jamón relleno

Total cooking time: approx. 16-20 minutes

Utensils: Bowl with lid (2 l capacity)

Flat oval soufflé dish (about 32 cm long)

Ingredients

- 150 g leaf spinach, with stalks removed
- 150 g fromage frais, 20 % fat content
- 50 g grated Emmental cheese
- pepper
- paprika
- 8 slices of cooked ham (400 g)
- 125 ml water
- 125 ml cream
- 2 tbsps flour (20 g)
- 2 tbsps butter or margarine (20 g)
- 1 tsp butter or margarine to grease the dish

Tip: You can buy ready-made béchamel sauce and use it for this recipe

Greece

AUBERGINES WITH MINCE STUFFING

Melitsánes jemistés mé kimá

Total cooking time: approx. 20-24 minutes

Utensils: Bowl with lid (1 l capacity)

Flat oval soufflé dish with lid (about 30 cm long)

Ingredients

- 2 aubergines, with stalks removed (weighing about 250 g each)
- Salt
- 3 tomatoes (approx. 200 g)
- 1 tsp olive oil to grease the bowl
- 2 onions (100 g), chopped
- 4 mild green chilli peppers
- 200 g minced meat (beef or lamb)
- 2 cloves of garlic, crushed
- 2 tbsps smooth leafed parsley, chopped
- salt & pepper
- rose paprika (light paprika)
- 60 g Feta cheese, diced

Tip: You can use courgettes instead of aubergines.

1. Chop the spinach into small pieces, mix with the cheese and the fromage frais and season to taste.
2. Place a tablespoon of the filling on top of each slice of cooked ham, and roll up. Spear the ham with a wooden skewer to fasten it.

3. Make a béchamel sauce; to do this pour the liquid into the bowl, cover, and heat.

3-4 Min. ☼ 900 W

Mix the flour and butter to make a roux, add to the liquid, and whisk with an egg whisk until dissolved. Cover, bring to the boil, and allow the thicken.

1-2 Min. ☼ 900 W

Stir and taste.

4. Place the sauce into the greased dish, position the filled rolls of ham onto the sauce and cook with lid.

12-14 Min. ☼ 630 W

Allow the rolls of ham to stand for about 5 minutes after cooking.

1. Cut the aubergines in half lengthways. Remove the flesh inside with a teaspoon, leaving about 1 cm of flesh on the skin. Salt the aubergines. Dice the flesh.

2. Skin two tomatoes, cut away the stem area and dice the rest.

3. Grease the bowl with the olive oil, add the onions, cover, and braise.

2-3 Min. ☼ 900 W

4. Cut out the stalks of the sweet chilli peppers, remove the seeds, and cut into rings. Keep a third of these for garnish. Mix the minced meat with the aubergines, onions and tomatoes, the chilli rings, the crushed garlic clove and the parsley, and season.

5. Dab the hollowed out aubergine halves dry. Fill each half with the minced meat mixture, spread out the Feta cheese on top, and then put the rest of the mixture on top.

6. Garnish the aubergine halves with the slices of tomato and chilli rings, place into the greased dish, cover and cook.

18-21 Min. ☼ 630 W

Allow the aubergines to stand for about 2 minutes after cooking.



MEAT, FISH AND POULTRY

France

SOLE FILLETS

Filets de sole

Total cooking time: approx. 11-13 minutes

Utensil: shallow, oval oven dish with lid
(approx. 26 cm long)

Ingredients

- 400 g sole fillets
- 1 lemon, whole
- 2 tomatoes (150 g)
- 1 tsp butter or margarine for greasing
- 1 tbsp vegetable oil
- 1 tbsp parsley, chopped
- salt & pepper
- 4 tbsps white wine (30 ml)
- 2 tbsps butter or margarine (20 g)

1. Wash the sole fillets and pat them dry. Remove any bones.
2. Cut the lemon and the tomatoes into thin slices.
3. Grease the oven dish with butter. Place the fish fillets inside and drizzle the vegetable oil over them.
4. Sprinkle parsley over the fish, place the tomato slices on top and season. Place the lemon slices on top of the tomatoes and pour the white wine over them.
5. Place small pots of butter on top of the lemon, cover and cook.

11-13 Min. ## 630 W

After cooking allow the fish fillets to stand for approx. 2 minutes.

Tip:

This recipe can also be used for Haddock, Halibut, Mullet, Plaice or Cod.



VEGETABLES, NOODLES, RICE AND DUMPLINGS

Austria

SPINACH GRATIN

Spinatauflauf

Total cooking time: approx. 37-42 minutes

Utensils: Bowl with lid (capacity 2 l)

Flat, oval dish (length: approx 26 cm)

Ingredients

- 2 tbsps butter or margarine (20 g)
- 1 onion (50 g), finely chopped
- 600 g leaf spinach, deep-frozen
- salt & pepper
- nutmeg
- garlic powder
- 1 tsp butter or margarine (for greasing the pan)
- 500 g boiled potatoes, sliced
- 200 g cooked ham, diced
- 4 eggs
- 125 ml crème fraîche
- 100 g grated cheese (e.g. Gouda)
- paprika pepper to sprinkle over the top

1. Spread the butter on the bottom of the dish. Add chopped onion, cover and cook.
2-3 Min. ## 900 W
2. Add spinach, cover and cook. Stir once or twice halfway through.
12-14 Min. ## 900 W
Pour off liquid and add seasoning to spinach.
3. Grease the dish. Place alternate layers of potato slices, diced ham and spinach in the dish. The top layer should be spinach.
4. Mix the eggs with the cream, add salt and pepper and pour over the vegetables. Cover the casserole with the grated cheese and sprinkle with ground paprika.
23-25 Min. ## 630 W
Allow the dish to stand for approx. 10 minutes after cooking.

Tip:

Ingredients can be varied as desired (using broccoli, salami, noodles, for example).

VEGETABLES, NOODLES, RICE AND DUMPLINGS



Switzerland

KOHLRABI IN DILLSAUCE

Kohlrabi in Dillsauce

Total cooking time: approx. 10¹/₂-13¹/₂ minutes

2 servings

Utensils: 2 bowls with lids (capacity 1 l)

Ingredients

- 400 g kohlrabi, sliced (approx. 2)
- 4-5 tbsp water
- 2 tbsps butter or margarine (20 g)
- 150 ml crème fraîche
- salt & pepper
- nutmeg & ground paprika
- lemon juice
- 1 bunch dill, finely chopped

Italy

TAGLIATELLE WITH CREAM AND BASIL SAUCE

Tagliatelle alla panna e basilico (makes 2 servings)

Total cooking time: approx. 16-22 minutes

Utensils: bowl with lid (2 l capacity)

round soufflé dish (approx. 20 cm diameter)

Ingredients

- 1 l water
- 1 tsp salt
- 200 g tagliatelle
- 1 clove of garlic
- 15-20 basil leaves
- 200 g crème fraîche
- 30 g grated Parmesan cheese
- salt & pepper

Switzerland

TESSINER RISOTTO

Tessiner Risotto

Total cooking time: approx. 20-25 minutes

Utensil: bowl with a lid (2 l capacity)

Ingredients

- 50 g streaky bacon
- 2 tbsps butter or margarine (20 g)
- 1 onion (50 g), finely chopped
- 200 g pudding rice (Arboris)
- 400 ml meat stock
- 70 g Sbrinz cheese (if you are unable to obtain this type of Swiss cheese, use Emmental instead)
- pinch saffron
- salt & pepper

1. Place the kohlrabi and water in the dish, cover and cook. Stir once halfway through.

9-12 Min. ☼ 900 W

Pour off the liquid

2. Spread the butter in the bowl. Add the cream and heat uncovered. Do not allow to boil! approx. **1¹/₂ Min. ☼ 900 W**
3. Add salt, seasonings and lemon juice as desired. Fold in the dill and pour the sauce over the kohlrabi. Allow the kohlrabi to stand for approx. 2 minutes after cooking.

Tip:

Black salsify can be used instead of kohlrabi.

1. Place the water and the salt into the bowl, cover and bring to the boil.

9-11 Min. ☼ 900 W

2. Add the pasta, bring to the boil again, and then simmer.

1. **1-2 Min. ☼ 900 W**2. **6-9 Min. ☼ 270 W**

3. Meanwhile rub the garlic cloves over the soufflé dish. Chop the basil leaves. Keep some aside for garnishing.
4. Drain the pasta well. Stir in the crème fraîche and sprinkle the basil over the pasta.
5. Add the parmesan cheese, salt and pepper, place into a soufflé dish and stir. Garnish the dish with basil and serve hot.

1. Cut the bacon into cubes. Spread the butter over the base of the bowl. Place the onions and bacon cubes, cover, and braise.

2-3 Min. ☼ 900 W

2. Add the rice, fill with the meat stock, bring to the boil, and then simmer.

1. **3-5 Min. ☼ 900 W**2. **15-17 Min. ☼ 270 W**

Allow the rice to stand for about 3-5 minutes after cooking.

3. Mix the cheese with the saffron and season to taste.

Tip:

Braised chanterelle mushrooms, or button mushrooms and a mixed salad go very well with this dish.



VEGETABLES, NOODLES, RICE AND DUMPLINGS

Italy

LASAGNE AL FORNO

Total cooking time: approx. 18-25 minutes

Utensils: Bowl with lid (2 l capacity)
shallow square soufflé mould with lid
(approx. 20 x 20 x 6 cm)

Ingredients

300 g tinned tomatoes
50 g ham, finely cubed
1 onion (50 g), finely chopped
1 clove of garlic, crushed
250 g minced meat (beef)
2 tbsps mashed tomato (30 g)
salt & pepper
oregano, thyme, basil, nutmeg
150 ml cream (crème fraîche)
100 ml milk
50 g grated Parmesan cheese
1 tsp mixed chopped herbs
1 tsp olive oil
1 tsp vegetable oil to grease the mould
125 g lasagne verde
1 tbsp grated Parmesan cheese
1 tbsp butter or margarine

1. Cut the tomatoes into slices, mix with the ham, onion cubes, garlic, minced meat and mashed tomato. Season and cook with the lid on.

5-8 Min. ## 900 W

2. Mix the cream with the milk, Parmesan cheese, herbs, oil and spices.
3. Grease the soufflé mould and cover the bottom of the mould with about $\frac{1}{3}$ of the pasta. Put half of the minced meat mixture on the pasta and pour on some sauce. Put an additional $\frac{1}{3}$ of the pasta on top followed by another layer of the minced meat mixture and some sauce, finishing with the remaining pasta on top. Finally, cover the pasta with lots of sauce and sprinkle with Parmesan cheese. Place butter flakes on top and cook with the lid on.

13-17 Min. ## 630 W

After cooking, let the lasagne stand for approximately 5-10 minutes.

Greece

POTATO-GARLIC PATÉ

Skordaliá mé patates

Total cooking time: approx. 8-10 minutes

Utensils: bowl with lid (capacity 1 l)

Ingredients

400 g boiled potatoes (with skins)
2-3 tbsp water
2-3 garlic cloves
6 tbsps olive oil
6 tbsps meat stock
salt
juice of one lemon
1 mild chilli pepper

1. Place the potatoes and water in the dish. Cover and cook. Stir once halfway through.

8-10 Min. ## 900 W

2. Peel the potatoes and press through a potato press or a fine sieve.
3. Crush the garlic cloves with the garlic press and add to the potatoes.
4. Add olive oil, meat stock, salt and lemon juice with the potatoes to taste, and stir until a smooth mixture is formed. Add more oil or stock as required.
5. Decorate the paté with chilli pepper rings and serve.

VEGETABLES, NOODLES, RICE AND DUMPLINGS



Austria

BREAD DUMPLINGS

Semmelknödel

Total cooking time: approx. 8-11 minutes

Utensil: Bowl with lid (2 l capacity)

5 cups or ramekins

Ingredients

- 2 tbsps butter or margarine (20 g)
 1 onion (50 g), chopped finely
 approx. 500 ml milk
 200 g cubes of dry bread (from about 5 bread rolls)
 3 eggs

- Put the bread cubes in a bowl and pour the milk over it.
- Spread the fat over the base of the bowl, add the diced onions, cover and heat.
1-2 Min. ## 900 W
- Add the onions to the bread cubes. Beat the eggs, add and stir everything well to form a smooth dough. If necessary add more milk.
- Distribute the dough equally into the 5 cups or ramekins, cover with microwave film, arrange around the edge of the turntable plate, and cook.
7-9 Min. ## 900 W
 Allow the dumplings to stand for about 2 minutes after cooking. Turn them out onto a plate before serving.

DRINKS, DESSERTS AND CAKES



Germany

SEMOLINA PUDDING WITH RASPBERRY SAUCE

Grießflammeri mit Himbeersauce

Total cooking time: approx. 15-20 minutes

Utensil: bowl with lid (2 l capacity)

Ingredients

- 500 ml milk
 40 g sugar
 15 g chopped almonds
 50 g semolina
 1 egg yolk
 1 tbsps water
 1 egg white
 250 g raspberries
 50 ml water
 40 g sugar

- Place the milk, sugar and almonds in the bowl, cover and heat.
3-5 Min. ## 900 W
- Add the semolina, stir, cover and cook.
10-12 Min. ## 270 W
- Beat the egg yolk with the water in a cup, and stir into the hot mixture. Beat the egg white until it is stiff, and fold it into the mixture. Pour the pudding mixture into ramekins or small dishes.
- To make the sauce wash the raspberries, dab them dry carefully, and place them in a bowl with the water and sugar. Cover, and heat.
2-3 Min. ## 900 W
- Purée the raspberries and serve either hot or cold with the semolina pudding.

Germany

HOT LEMONADE

Heiße Zitrone

Total cooking time: 1 minute

Utensils: Glass for lemon tea (150 ml)

Ingredients

- 100 ml water
 juice of one lemon
 2-3 tsp sugar

- Mix water and lemon juice in a glass and heat. approx. **1 Min. ## 900 W**
 Add sugar to taste.

ENGLISH



DRINKS, DESSERTS AND CAKES

Netherlands

HOT PUNCH

Vuurdrank

For 10 servings

Ingredients

500 ml white wine
 500 ml dry red wine
 500 ml rum, 54 % vol
 1 unwaxed orange
 3 sticks of cinnamon
 75 g sugar
 10 tsp Klontjes (crystallised sugar lumps)

1. Pour the alcoholic ingredients into the bowl. Thinly pare the skin of the orange, and add the orange peel, together with the cinnamon and the sugar, to the alcohol. Cover and heat.

8-10 Min. ## 900 W

Remove the orange peel and the cinnamon. Place a teaspoon of the klontjes (crystallised sugar lumps) into 10 punch glasses, pour in the punch, and serve.

England

CHOCOLATE CAKE

Chocolate Cake

Total cooking time: 15-21 minutes

Utensils: Round cake dish (diam. 21 cm, height 10 cm)

Ingredients

175 g butter or margarine
 175 g sugar
 3 eggs
 175 g flour
 1 tsp baking powder
 2 tbsps cocoa (20 g)
 50 ml milk

1. Beat the butter until frothy and slowly mix in the sugar. Add the eggs gradually, mixing well. Mix together the flour, baking powder and cocoa. Add milk and mix thoroughly.

2. Grease the pan, pour in dough and cook.

8-10 Min. ## 630 W

3. Use a wooden skewer to check that the cake is done.

Allow the cake to cool for 10 minutes in the dish.

DRINKS, DESSERTS AND CAKES



France

PEARS IN CHOCOLATE SAUCE

Poires au chocolat

Total cooking time: approx. 8-13 minutes

Utensils: bowl with lid (2 l capacity)

bowl with lid (1 l capacity)

Ingredients

4 pears (600 g)
 60 g sugar
 1 pack vanilla sugar (10 g)
 1 tbsps pear liqueur, 30 % vol
 150 ml water
 130 g dark chocolate
 100 g crème fraîche

Tip: Delicious when served with a ball of vanilla ice cream.

1. Peel the pears whole.
2. Place the sugar, vanilla sugar, the pear liqueur and the water into the bowl, stir, cover and heat.
1-2 Min. ☞ 900 W
3. Place the pears into the liquid, cover and cook.
5-8 Min. ☞ 900 W
Take the pears out of the cooking liqueur, and place in a cold place.
4. Pour 50 ml of the cooking liqueur into the smaller bowl. Add the chopped chocolate and the crème fraîche, cover, and heat.
2-3 Min. ☞ 900 W
5. Stir the sauce well. Pour the sauce over the pears, and serve.

Austria

CHOCOLATE WITH WHIPPED CREAM

Schokolade mit Schlagobers 1 portion

Total cooking time: about 1 minute

Utensil: large cup or mug (capacity 200 ml)

Ingredients

150 ml milk
 30 g bar of chocolate grated
 30 ml cream
 chocolate vermicelli

1. Pour the milk into the cup or mug. Add the grated chocolate to the milk, stir and heat. Stir halfway through.
about **1 Min. ☞ 900 W**
2. Whip the cream until it is stiff, place on top of the chocolate, sprinkle with chocolate vermicelli and serve.

Sweden

PISTACHIO RICE PUDDING WITH STRAWBERRIES

Pistaschris med zordgubbe

Total cooking time: approx. 27-31 minutes.

Utensil: Tall bowl with a lid (2 l capacity)

Ingredients

125 g long grain rice
 150 ml milk
 175 ml water
 1 vanilla pod
 pinch salt
 50 g sugar
 250 g strawberries
 40 g sugar
 40 ml Cointreau (40 % vol orange liqueur)
 200 ml cream
 1 egg white
 50 g pistachio nuts (shell off)

1. Place the rice in the bowl and fill with the liquid ingredients. Slit open the vanilla pod, add to the rice with the salt and the sugar, cover, and cook.
 1. **3-5 Min. ☞ 900 W**
 2. **24-26 Min. ☞ 270 W**
Allow the rice to stand for about 5 minutes after cooking.
2. Cut the strawberries in half, mix in the sugar and the Cointreau.
3. Remove the vanilla pod from the rice, and cool the rice in a cold water bain marie, while stirring. Whip the cream and the egg white separately until both are stiff. Fold in first the pistachios, then the cream, and finally the egg white into the cold rice.
4. Place the rice in a large dish. Make a well in the top and place the strawberries in the well.

ENGLISH



DRINKS, DESSERTS AND CAKES

Germany

CHEESECAKE

Käsekuchen

makes 12 portions

Total cooking time: approx. 21-27 minutes

Utensil: spring form pan (approx. 26 cm diameter)

Ingredients

300 g flour
 1 tbsp cocoa
 3 tsp baking powder (9 g)
 150 g sugar
 1 egg
 150 g butter or margarine
 1 tsp butter or margarine to grease the form
 100 g butter or margarine to grease the pan
 100 g sugar
 1 pack vanilla sugar (10 g)
 3 eggs
 400 g fromage frais, 20 % fat content
 1 pack powdered vanilla pudding mix (40 g)

- Mix the flour and cocoa with the baking flour. Add the sugar, egg and butter and use the kneading hook on the hand-held blender to knead.
- Grease the pan, roll out $\frac{2}{3}$ of the dough and place it in the pan. Lift the edges 2 cm to form a rim. Pre-bake the pastry.
6-8 Min. ## 630 W
- Whisk the butter until light and fluffy, add the sugar and eggs one at a time. Finally add the fromage frais and the powdered vanilla pudding mix.
- Spread the filling over the pre-baked dough and add the remaining crumbling dough on the cake and bake.
15-19 Min. ## 630 W

Denmark

FRUIT JELLY WITH VANILLA SAUCE

Rødgrød med vanilie sovs

Total cooking time: approx. 8-12 minutes

Utensils: Dish with lid (2 l capacity)

Ingredients

150 g redcurrants, washed and stalks removed
 150 g strawberries, washed and haulms removed
 150 g raspberries, washed and haulms removed
 250 ml white wine
 100 g sugar
 50 ml lemon juice
 8 gelatin leaves
 300 ml milk
 inside of $\frac{1}{2}$ vanilla pod
 30 g sugar
 15 g food thickener

- Put some of the fruit to one side for decoration. Purée the rest of the fruit with the white wine, put it into a dish, cover and heat.
5-7 Min. ## 900 W
 Fold in the sugar and the lemon juice.
- Soak the gelatin in cold water for approx. 10 minutes, then take it out and squeeze dry. Stir the gelatin in with the hot purée until it has dissolved. Place the jelly in the refrigerator and leave to set.
- To make the vanilla sauce, put the milk into a dish. Slit the vanilla pod and remove the inside. Stir this in with the milk, together with the sugar and the food thickener, cover and cook, stirring during cooking and again at the end.
3-5 Min. ## 900 W
- Turn out the jelly onto a plate and decorate with the whole fruit. Add the vanilla sauce.

Tip:

You can also use defrosted frozen fruits.

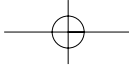

· SERVICE NIEDERLASSUNGEN · ADDRESSES D'ENTRETIEN · ONDERHOUDSADRESSEN · DIRECCIONES DE SERVICIO · INDIRIZZI DI SERVIZIO ·

ÖSTERREICH

Bei einer Reklamation Ihrer SHARP Mikrowelle wenden Sie sich bitte an Ihren Fachhändler oder an eine der nachfolgend aufgeführten SHARP SERVICE Niederlassungen.

Manfred Mayer GmbH, Stipcakgasse 6, 1234 Wien, Phone: 01-6093120, Fax: 01-6993629 / **MCL-Service GmbH**, Deutschstr. 19, 1232 Wien, Phone: 01-6168800, Fax: 01-6168800-15 / **Karl Rother**, Simmeringer Hauptstr. 11, 1110 Wien, Phone: 01-7498432, Fax: 01-7498432-12 / **Roland Göschl**, Bayerhamerstr. 12c, 5020 Salzburg, Phone: 662-882307, Fax: 662-881926 / **Franz Schuhmann**, Gablonzerweg 18, 4030 Linz, Phone: 732-382280, Fax: 732-382280-8 / **Arnold Moser**, An der Heufurt 28, 6900 Bregenz, Phone: 5574-75777, Fax: 5574-75777 / **Anton Reitmeir**, Leopoldstr. 57, 6020 Innsbruck, Phone: 512-562277, Fax: 512-562277 / **Scheuermann**, Rennsteinerstr. 8, 9500 Villach, Phone: 4242-21174, Fax: 4242-21174 / **Pichler**, Am Wagrain 342, 8055 Graz, Phone: 316-291292, Fax: 316-291292 / **Audio Video Service**, Sonnengasse 13, 9020 Klagenfurt, Phone: 463-43114, Fax: 463-43113

BELGIUM

En cas d'une réclamation concernant une four a micro-onde SHARP, nous vous prions de vous adresser à votre spécialiste ou à une adresse des SHARP Services suivantes.

Indien uw magnetron problemen geeft kunt u zich wenden tot uw dealer of een van de onderstaande Sharp service centra.

SHARP ELECTRONICS, Phone: 0900-10158, Web: <http://www.sharp.be>

AVTC, Kleine Winkellaan 54, 1853 Strombeek-Bever, Phone: 02/2674019, Fax: 2679670,

ETS HENROTTE, Rue Du Campinaire 154, 6240 Farciennes, Phone: 071/396290, Fax: 391237

Nouvelle Central Radio (N.C.R.), Rue des Joncs 15 L-1818 HOWALD Phone: 00352404078, Fax: 402085
Service Center Deinze, Kapellestraat, 95, 9800 DEINZE Phone: 09-386.76.67, Fax: 09-386.97.95

NEDERLAND

Indien uw magnetron problemen geeft kunt u zich wenden tot uw dealer of naar onderstaand Sharp Service Centrum.

SHARP ELECTRONICS BENELUX BV, Helpdesk -, Postbus 900, 3990 DW Houten, Telefoon: 0900-7427723,

Web: <http://www.sharp.nl>

DEUTSCHLAND

Bei einer Reklamation Ihrer SHARP Mikrowelle wenden Sie sich bitte an Ihren Fachhändler oder an eine der nachfolgend aufgeführten SHARP SERVICE Niederlassungen.

03058 Groß Garglow, Cottbuser Str.129, Bernd Mindach, Tel: 0355-539987, Fax: 0355-5265685 / **04159 Leipzig**, Max-Liebermann-Straße 4 a, Rudi Franz, Tel: 0341-9112525, Fax: 0341-9112526 / **04600 Altenburg**, Wallstr. 35, Mechanik Altenburg E.G., Tel: 03447-311102, Fax: 03447-315253 / **06217 Merseburg**, Gotthardstraße 30, Looke & May GmbH, Tel: 03461-214121, Fax: 03461-216891 / **06295 Eisleben**, Hallesche Straße 36, Hausger. Kundend. Eisleben, Tel: 03475-603079, Fax: 03475-747262 / **06618 Naumburg**, Wenzelstraße 15, Hausgeräte & Service GmbH, Tel: 03445-202016, Fax: 03445-202016 / **06844 Dessau**, Albrechtstraße 116-118, Dessau-Electric GmbH, Tel: 0340-261270, Fax: 0340-213332 / **07407 Rudolstadt**, Emil Hartmann Straße 2, Elektro Ernst Granowski, Tel: 03672-352123, Fax: 03672-357097 / **07987 Kahmer**, Dorfstraße 25, Elektro Riederer Haushaltgeräte, Tel: 03661-430142, Fax: 03661-482422 / **08280 Aue**, Juri-Gagarin-Ring 12a, EHS Hausgeräte GmbH, Tel: 03771-552222, Fax: 03771-552255 / **08523 Plauen**, Weststraße 63, Elektrotechnik Plauen GmbH, Tel: 03741-2120, Fax: 03741-212259 / **09221 Neukirchen**, Hauptstraße 74, Walther Elektro, Tel: 0371-217096, Fax: 0371-217090 / **09246 Pleiße**, Zepelinstraße 8 a, Hans Krempel Haustechnik GmbH, Tel: 03722-73780, Fax: 03722-737822 / **09328 Lunzenau**, Schulstraße 6, Peter Welsch GmbH, Tel: 037383-6434, Fax: 037383-6448 / **09376 Oelsnitz**, Bahnhofstraße 43, Elektrotechnik Oelsnitz-GmbH, Tel: 037298-2677, Fax: 037298-2678 / **12157 Berlin**, Cranachstraße 2, Elektro-Kittler, Tel: 030-85602602, Fax: 030-85602603 / **16866 Kyritz**, Hamburgerstr. 31, Schumacher Haustechnik GmbH, Tel: 033971-54137, Fax: 033971-54137 / **17235 Neustrelitz**, Glambeker Nebenstr. 10, Dieter Kroppen, Tel: 03981-204661, Fax: 03981-204667 / **18055 Rostock**, Timmermannstrat 5, Hetec, Tel: 0381-36231, Fax: 0381-36231 / **18435 Stralsund**, Kedingshäger Straße 78, RDS Haushaltsgeräte GmbH, Tel: 03831-391426, Fax: 03831-390121 / **20357 Hamburg**, Schulterblatt 132, Dieter Möller, Tel: 040-435332, Fax: 040-4302120 / **20537 Hamburg**, Eiffelstraße 398, Deubel+Höfermann Elektronik GmbH, Tel: 040-41365200, Fax: 040-41365299 / **22459 Hamburg**, Seesrein 35, Dieter A. Volbrecht VDI Klima und Kälte Service, Tel: 040 - 5517331, Fax: 040 - 5519996 / **23562 Lübeck**, Helmholtzstraße 12, Lutz H. Boenisch, Tel: 0451-51929, Fax: 0451-56787 / **24116 Kiel**, Eckernförder Straße 93, Jürgen Skop GmbH, Tel: 0431-13038, Fax: 0431-13811 / **24357 Fleckeby**, Südring 14, Kaack Elektro-Haushaltgeräte Service GmbH, Tel: 04354-700, Fax: 04354-1311 / **24975 Husby**, Flensburger Straße 41, Günter Josten, Tel: 04634-422, Fax: 04634-723 / **25770 Hemmingstedt**, Koesliner Straße 18, Dirk Stübner Diethmarscher Hausgeräte Service, Tel: 0481-64943, Fax: 0481-64764 / **26655 Westerstede**, Südring 37, Gerhard Ahrenholz GmbH, Tel: 04488-84770, Fax: 04488-847711 / **27404 Heeslingen**, Kirchstraße 9-11, Helmut Willenbrock Elektro-Kälte-Radio, Tel: 04281-1031, Fax: 04281-6467 / **27472 Cuxhaven**, Abschnede 198-200, Oskar Wieand & Sohn OHG, Tel: 04721-568811, Fax: 04721-568850 / **28207 Bremen**, Neidenburger Straße 20, Hansa Haushaltsgeräte Service GmbH, Tel: 0421-492526, Fax: 0421-440932 / **29439 Lüchow**, Güldenboden 25, Elektro-Kittler, Tel: 05841-709779, Fax: 05841-709780 / **30926 Seelze**, Lange-Feld-Straße 122, Strickling Werkkundendienst, Tel: 0511-4003999, Fax: 0511-40039920 / **34123 Kassel**, Heinrich-Hertz-Straße 9, KälteDienst v. Rappard, Tel: 0561-5809545, Fax: 0561-5809570 / **34128 Kassel**, Ahnatalstraße 84, Elektro Mohrhenne, Tel: 0561-61727, Fax: 0561-65470 / **35037 Marburg**, Wilhelmstraße 16, Hans-Georg Fuchs, Tel: 06421-22424, Fax: 06421-27549 / **35415 Pohlheim**, Ludwigstraße 13-15, Jung KDZ, Tel: 06403-61131, Fax: 06403-62151 / **36088 Hünfeld**, Hauptstr. 22, Elektro Vogt, Tel: 06652-2215, Fax: 06652-5782 / **37671 Hötter**, Krämerstraße 8, Elektro Nonn, Tel: 05271-7959, Fax: 05271-35053 / **39171 Altenwedding**, Friedensstr.25, Spiske IEM Installation-Elektronik-Montage, Tel: 039205-21279, Fax: 039205-80288 / **40476 Düsseldorf**, Rother Straße 21, Horst Leven, Tel: 0211-486025, Fax: 0211-443399 / **41065 Mönchengladbach**, Gutenbergsstraße 28, Horst Hommers Kundendienst-Center, Tel: 02161-603256u.57, Fax: 02161-651951 / **42781 Haan**, Talstraße 8 b, Horst Kerkühn Elektro-Haustechnik, Tel: 02129-4466+53550, Fax: 02129-34037 / **45219 Essen**, Corneliusstraße 39, R. Drengenburg, Tel: 02054-84114, Fax: 02054-15238 / **46045 Oberhausen**, Feldmannstraße 76, Dieter Kroppen, Tel: 0208-871711, Fax: 0208-876652 / **48165 Münster-Hiltrup**, Rohrkampstraße 23, Günter Pfeifer Großküchentechnik, Tel: 02501-3033, Fax: 02501-24277 / **51598 Friesenhagen**, Mühlenhof 6, Hans Krempel Haustechnik GmbH, Tel: 02734-7377, Fax: 02734-40618 / **52146 Würselen**, De Gasperistraße 6+10, Hubert Hamacher, Tel: 02405-9600+9609, Fax: 02405-2704 / **55130 Mainz**, Nur telefonische Annahmestelle, Norbert Schwamb GmbH, Tel: 06131-881070 / **55543 Bad Kreuznach**, Industriestraße, Hans Krempel Haustechnik GmbH, Tel: 0671-794335, Fax: 0671-794369 / **56070 Koblenz**, August-Horch-Straße 14, Hans Krempel Haustechnik GmbH, Tel: 0261-8909173, Fax: 0261-8909199 / **57080 Siegen**, Gosenbacher Hütte 44, Hans Krempel Haustechnik GmbH, Tel: 0271-354114, Fax: 0271-351408 / **59457 Werl**, Westdahlweg 2, MAYER Electro, Tel: 02922-3541, Fax: 02922-85382 / **63739 Aschaffenburg**, Maximilianstraße 8, Radio-Fernseh Reis, Tel: 06021-15177, Fax: 06021-15199 / **65239 Hochheim**, Elwiller Straße 14, Norbert Schwamb GmbH, Tel: 06146-4085, Fax: 06146-4088 / **65627 Elbtal-Hangenmeilingen**,

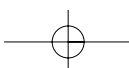

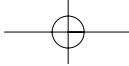

• SERVICE NIEDERLASSUNGEN • ADDRESSES D'ENTRETIEN • ONDERHOUDSADRESSEN • DIRECCIONES DE SERVICIO • INDIRIZZI DI SERVIZIO •

Am Ohlenrod 10, Rudi Wagner, Tel: 06436-3444, Fax: 06436-941387 / **65931 Frankfurt**, Nur telefonische Annahmestelle, Norbert Schwamb GmbH, Tel: 069-371525 / **66115 Saarbrücken**, Ludwigstr. 55-57, Edgar Reinert, Tel: 0681-9487070, Fax: 0681-9487060 / **67434 Neustadt**, Saarlandstraße 55, Hans Krempel Haustechnik GmbH, Tel: 06321-83077, Fax: 06321-83077 / **68309 Mannheim**, Heppenheimerstraße 23, Hans Krempel Haustechnik GmbH, Tel: 0621-7184611, Fax: 0621-7184618 / **68526 Ladenburg**, Am Sägewerk 2, Elektro Service Salinger, Tel: 06203-3341, Fax: 06203-16919 / **70186 Stuttgart**, Klippeneck Straße 1, Elektro Herterich Techn. Kundendienst, Tel: 0711-4687023, Fax: 0711-4687024 / **75236 Kämpfelbach**, Goethestraße 19, Horst Frei, Tel: 07232-1518, Fax: 07232-5238 / **76185 Karlsruhe**, Lotzbeckstraße 9, Electronic Service Franke, Tel: 0721-5700720-23, Fax: 0721-5700736 / **76872 Winden**, Hauptstraße 103, Hans Krempel Haustechnik GmbH, Tel: 06349-8571, Fax: 06349-3390 / **78462 Konstanz**, Nur telef. Annahmestelle, Elektro Herterich, Tel: 07531-27923 / **78737 Fluorn-Winzeln**, Schafbaumstraße 9, Edmund Schneider, Tel: 07402-482, Fax: 07402-8014 / **79650 Schopfheim**, Feldbergstraße 21, R. Grossmann, Tel: 07622-674510, Fax: 07622-61900 / **80339 München**, Schwanthalerstraße 110, Kesel & Schnitt, Tel: 089-505802, Fax: 089-5021596 / **85095 Denkendorf-Zandt**, Michlstraße 3, Elektro Pfeiffer, Tel: 08466-1319, Fax: 08466-1319 / **85609 München-Aschheim**, Waldweg 9a, Dieter Beise, Tel: 089-9034005, Fax: 089-9044859 / **86157 Augsburg**, Stadlberger Straße 67, J. Haslinger Elektro-Geräte Kundendienst, Tel: 0821-523125, Fax: 0821-526664 / **87439 Kempten**, Heiligkreuzer Straße 17, Radio Hartmann, Tel: 0831-594646, Fax: 0831-594648 / **89231 Neu-Ulm**, Gartenstraße 4, Elektrotechnik Schneider, Tel: 0731-85897, Fax: 0731-74681 / **91522 Ansbach**, Am Ring 17, Elektro Merk GmbH, Tel: 0981-89574, Fax: 0981-86715 / **90537 Feucht/Nürnberg**, Friedrich-Ebert-Straße 21, Herbert Geissler GmbH, Tel: 09128-7076-0, Fax: 09128-707636 / **93102 Pfatter**, Regensburger Straße 60, Franz Bernhard, Tel: 09481-90060, Fax: 09481-90061 / **94130 Obernzell**, Hameter Straße 31, Elektro Service Schurig, Tel: 08591-2400, Fax: 08591-1285 / **96052 Bamberg**, Aronstraße 2 a, Bernhard Jackl, Tel: 0951-9370245, Fax: 0951-9370247 / **97070 Würzburg**, Untere Johannitergasse 16, Radio Wels City Service GmbH, Tel: 0931-3557119, Fax: 0931-14151 / **98724 Neuhaus**, Eisfelder Straße 32, DLG Haustechnik GmbH, Tel: 03679-79060, Fax: 03679-790620 / **99096 Erfurt**, Goethestraße 14, Ernst Grüsser, Tel: 0361-3465719, Fax: 0361-3465719 / **99817 Eisenach**, Bahnhofstraße 17, Blitz Elektro-Elektronik GmbH, Tel: 03691-292930, Fax: 03691-292915

FRANCE

En cas de réclamation pour les fours micro-ondes SHARP, nous vous prions de vous adresser à votre spécialiste ou à l'une des stations techniques agréées SHARP suivantes :

A.A.V.I., 1, rue du Mont de Terre - 59818 Lesquin Cedex, Tél : 03.20.62.18.98 - Fax : 03.20.86.20.60 / **A.A.V.I. (Point d'Accueil)**, 9-11, rue Léon Trulin - 59000 Lille, Tél : 03.20.14.96.20 - Fax : 03.20.14.96.26 / **ATELIER ROUSSEL**, 12, Bld Flandre Dunkerque - 56100 Lorient, Tél : 02.97.83.07.41 - Fax : 02.97.87.02.36 / **BASTIA TELE VIDEO**, Immeuble Le Béarn - Av. de la libération - 20600 Bastia, Tel : 04.95.30.81.29 - Fax 04.95.30.85.23 / **C.M.T.S.**, 38, rue des Ormeaux - 75020 Paris, Tél : 01.43.70.20.00 - Fax : 01.43.70.36.46 / **ELECTRONIC SERVICE PLUS**, 5, bd LOUIS XI - ZI le Meneton - 37000 Tours, Tél : 02.47.77.90.90 - Fax : 02.47.77.90.91 / **ELECTRO SERVICE**, 21, rue de Mulhouse - B.P 122 - 68313 Illzach, Tél : 03.89.62.50.00 - Fax : 03.89.50.80.14 / **M.R.T.**, 74, Rue Albert Einstein - 72021 Le Mans Cedex, Tél : 02.43.28.52.20 - Fax : 02.43.24.93.81 / **ROSSIGNOL**, ZI du Brezet Est - 6 rue P.Boulangier - 63100 Clermont Ferrand, Tél : 04.73.98.64.64 - Fax : 04.73.92.28.79 / **S.T.E.**, 3, chemin de l'Industrie - 06110 Le Cannet Rocheville, Tél : 04.93.46.05.00 - Fax : 04.93.46.51.18 / **S.T.R.** **AQUITAINE**, 111, rue Bouthier - B.P 27 - 33015 Bordeaux, Tél : 05.57.80.78.07 - Fax : 05.57.80.78.08 / **S.T.V.S.**, 1, rue de la Presse - 42000 Saint Etienne, Tel : 0825.898.903 - Fax : 04.77.79.48.70 / **S.T.V.S.**, 10, chemin Saint Gobin - 69 190 Saint fons, Tél : 04.72.89.06.89 - Fax : 04.72.89.06.99 / **S.T.V.S. (point d'accueil)**, 143 av Maréchal de Saxe - Entrée : 54 rue Villeroy - 69003 Lyon, Tél : 04.78.62.07.05 - Fax : 04.78.62.13.65 / **TECH SERVICE**, 15 rue du château de ribaute - ZA ribaute 2 - 31130 Quint Fonsegrives, Tel : 05.62.57.63.90 - Fax : 05.62.57.63.99 / **TIMO VIDEO**, 131 chemin des bassins- Zone Europarc - Hameau D - 94000 Creteil, Tél : 01.43.39.08.18 - Fax : 01.43.39.08.07 / **U.N.T.D.**, 1, rue des Laurdines - 76000 Rouen, Tél : 02.35.72.28.04 - Fax : 02.35.73.18.32 / **VIDEO TECHNOLOGY**, 8, Allée de la Fontaine des Tournelles - Z.I. - 77230 SaintMard, Tel : 01.60.54.99.44 - Fax : 01.60.54.99.45

ITALIA

NEL CASO SI VERIFICASSERO PROBLEMI ALLA VOSTRA APPARECCHIATURA POTRETE RIVOLGERVI PRESSO UN NOSTRO CENTRO DI ASSISTENZA AUTORIZZATO SHARP

C.A.T. Di Bellone, Via Dell'areoporto, 76, 64100, Teramo, Tel: 0861415745, Fax: 0861212117 / **C.R. Elettronica**, Via Amiternum 38, 67100, L'Aquila, Tel: 0862-321442, Fax: 0862-314323 / **Elettrovideo Snc**, Via Tiburtina V. 64, 65124, Pescara, Tel: 08552020, Fax: 085-52020 / **Riccardi Cosimo**, Via S.Stefano 51, 75100, Matera, Tel: 0835-333671, Fax: 0835-333671 / **Ld Service Di Lavano E De Biasi**, Via Viviani 2, 85100, Potenza, Tel: 0971-472578, Fax: 0971-472578 / **Cozzupoli & Crupi**, Via R. Campi Primo Tronco 103, 89126, Reggio Calabria, Tel: 0965-24022, Fax: 0965-310778 / **Ater Snc**, Via Naz.Pentimiele 159/A-B, 89100, Reggio Calabria, Tel: 0965-47051, Fax: 0965-47855 / **Audiovideo Snc**, Via A. De Gasperi 44, 88018, Vibo Valentia, Tel: 0963-45571, Fax: 0963-45572 / **Battaglia Saverio**, Via C. Colombo 85, 88063, Catanzaro, Tel: 0961-33824, Fax: 0961-737337 / **Ciano Giuseppe**, Via Circonvallaz.Sud, 89029, Taurianova Rc, Tel: 0966-643483, Fax: 0966-614946 / **Lab. Tv Dei F.Lli Aiello Snc**, Via Torino 121/123, 88074, Crotona Cz, Tel: 0962-20889, Fax: 0962-24254 / **Mea Giuseppe**, Via L. Einaudi Trav.I 16, 88048, Lamezia T. (Cz), Tel: 0968-437520, Fax: 0968-437520 / **Medaglia Giolindo**, Via Torrazzo 60/62, 88063, Catanzaro Lido, Tel: 0961-31626, Fax: 0961-31626 / **S.A.T.E Di Dodaro**, Via Degli Stadi 28/F, 87100, Cosenza, Tel: 0984-482337, Fax: 0984-482337

Se.Ri.El.Co., V.Delle Medaglie D'oro 163, 87100, Cosenza, Tel: 0984-33152, Fax: 0984-33152 / **Satep (Casoria NA)**, Via Nazionale Delle Puglie, 176, 80026, Casoria (NA), Tel: 081-7590706, Fax: 081-7590706 / **Audio Service Snc**, Via Cattaneo 4/6, 81100, Caserta, Tel: 0823-329099, Fax: 0823-353686 / **Drf Eletr.** Di Rubbo, Via M.Pacifico 118, 82100, Benevento, Tel: 0824-62416, Fax: 0824-62416 / **Elettronica D'Argenio**, Via Nazion. Torrette, 195, 83013, Mercogliano (Av), Tel: 0825-681590, Fax: 0825-681590 / **Elettronica Service**, Viale Europa, 15, 80053, Castell. Stabia, Tel: 081-8728280, Fax: 081-8728280 / **Errediesse Service**, Via P. Mascagni 74/76, 80128, Napoli, Tel: 081-5794825, Fax: 081-5791899 / **M.C. Elettronica Snc**, Via Dei Mille 138, 84100, Salerno (Sa), Tel: 089-330591, Fax: 089-336836 / **Menna Elettronica Srl**, Via Nazionale Delle Puglie 294, 80026, Casoria (Na), Tel: 081-5840726, Fax: 081-594277 / **Satec Di Correr Snc**, Via Libertà 307, 81024, Maddaloni (Ce), Tel: 0823-341088, Fax: 0823-343011 / **Video Eletr. 2 Di Nastì**, Via Ant.Pio 74/76, 80126, Napoli, Tel: 081-7676300, Fax: 081-7284347 / **Audio Video Center Snc**, Via F. Vandelli 23/29, 41100, Modena, Tel: 059-235219, Fax: 059-210265 / **Ass.Electron Di Fogli**, Via F.Lli Aventi 19, 44100, Ferrara, Tel: 0532-903250, Fax: 0532-903250 / **Ma.Pi. Snc**, Via T.Azzolini 3, 40132, Bologna, Tel: 051-6414115, Fax: 051-406848 / **Masini Service**, Via Mediterraneo 24, 47041, Bellaria (Fo), Tel: 0541-347714, Fax: 0541-324413 / **Nuova Tecnocoop**, Via Armellini 28/30/32, 47037, Bellariva Rimini, Tel: 0541-370812, Fax: 0541-370812 / **Parmaservice Sas**, Via Benedetta 47/A, 43100, Parma, Tel: 0522-271666, Fax: 0521-271666 / **Rimpelli Nelusco Snc**, Via Marchelli 7/C, 42100, Reggio Emilia, Tel: 0522-323740, Fax: 0522-376967 / **Rip.Eletr.Ravenna**, Via Reale, 27/C 48010, Camerlona (Ra), Tel: 0544-521500, Fax: 0544-521100 / **Rte Di I. Catellani & C.**, Via Premuda 38/V, 42100, Reggio Emilia (Re), Tel: 0522-381277, Fax: 0522-381788 / **Stema Snc**, V.Le Bologna, 92/A 47100, Forlì, Tel: 0543-704475, Fax: 0543-702742 / **Technolab Snc**, Via Romea 36, 48100, Ravenna, Tel: 0544-64008, Fax: 0544-476497 / **Tecnoservice.Com**, Via Longhi 16/A/B, 40128, Bologna, Tel: 051-360986, Fax: 051-366863 / **A.V.R. Sas Di Di Renzo**, Via Colonna 20/8, 33170, Pordenone, Tel: 0434-27669, Fax: 0434-523661 / **Astec S.N.C. Di Zoccarato**, Via

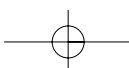

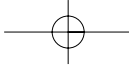

• SERVICE NIEDERLASSUNGEN • ADDRESSES D'ENTRETIEN • ONDERHOUDSADRESSEN • DIRECCIONES DE SERVICIO • INDIRIZZI DI SERVIZIO •

Pecenco 4, 34127, Trieste, Tel: 040-574745, Fax: 040-577923 / **Cm Elettronica Snc**, Via G.Galilei 2, 33010, Tavagnacco (Ud), Tel: 0432-572172, Fax: 0432-573788 / **Contr.El.**, Via Rossetti 51/C, 34141, Trieste, Tel: 040-368387, Fax: 040-638117 / **Tecnoffly Snc**, Via Cappuccini 11/2, 34170, Gorizia, Tel: 0481-32732, Fax: 0481-546740 / **A.P. Rip. Arduini Piero**, Via Licinio Refice 192, 03100, Frosinone, Tel: 0775-291267, Fax: 0775-291267 / **Centro E.L.Va. Snc**, Via Attilio Mori 19/21, 00176, Roma, Tel: 06-2148641, Fax: 06-2753048 / **El.S.A.R.**, Via S.Sotero 36, 00165, Roma, Tel: 06-6380516, Fax: 06-6380973 / **Elettronica 81**, Via Ezio 56/58, 04100, Latina, Tel: 0773-694608, Fax: 0773-663511 / **Italreg Di Abano**, Parco Belvedere Conca 74, 04024, Gaeta, Tel: 0771-470851, Fax: 0771-470851 / **Palmieri F.**, Via S.Polledrara 219, 03100, Frosinone, Tel: 0775-291485, Fax: 0775-291485 / **S.A.R.E. S.R.L.**, Via Barbana 35/37, 00142, Roma, Tel: 06-5406796, Fax: 06-5412736 / **Video Serv. Sas Di Calabrese**, Str Teverina Km 2, 400 L. Pantanese, 01100, Viterbo (Vi), Tel: 0761-251557, Fax: 0761-251558 / **Caudullo Salvatore**, Via Cavour 11/R, 17100, Savona, Tel: 019-8386251, Fax: 019-829654 / **Centro Assistenza Tecn.**, Via Metella 3, 18039, Ventimiglia (Im), Tel: 0184-239011, Fax: 0184-239015 / **G.A.T.E. Snc**, Passo P.Carrega 24/A, 16141, Genova, Tel: 010-8361543, Fax: 010-8364571

Gse S.R.L., Via Rimassa 183 R, 16122, Genova (Ge), Tel: 010-5536076, Fax: 010-5536113 / **Rapisarda G.**, Via Argine Destro 299, 18100, Imperia, Tel: 0183-710771, Fax: 0183-710771 / **Rien Snc**, Via Valle 17/19, 19124, La Spezia, Tel: 0187-21925, Fax: 0187-21925 / **Tognetti Snc**, Via Lunigiana 589, 19100, La Spezia, Tel: 0187-507656, Fax: 0187-507656 / **A.E. Snc**, V.Acerbi 28, 20161, Milano, Tel: 02-66220906, Fax: 02-6466930 / **A.T. Electronics**, Via G. Da Cernate 76, 20141, Milano, Tel: 02-89501602, Fax: 02-89502937 / **C.A.T. Bm**, Via Per Desio 22, 20030, Bovisio Masciago (Mi), Tel: 0362-558421, Fax: 0362-558887 / **Cat Electronic Snc**, Via Togliatti 8, 20077, Melegnano (Mi), Tel: 02-9834498, Fax: 02-9837559 / **Crel S.N.C.**, Via Carducci, 23100, Sondrio, Tel: 0342-216538, Fax: 0342-216538 / **Electronic's Center**, Via G.Giulini 9, 22100, Como, Tel: 031-279820, Fax: 031-261791 / **Elettronica Cappi**, Via Gorizia, 14/B, 23100, Sondrio, Tel: 0342-210459, Fax: 0342-210459 / **Elettrotecnica Di Ronchi**, Via Milano 74/B, 25126, Brescia, Tel: 030-317673, Fax: 030-3735252 / **Microcentro**, Via Falloppio 11, 20110, Milano, Tel: 02-26827306, Fax: 02-2826711 / **Morini Daniele**, Via Maiocchi, 10, 27058, Voghera (Pv), Tel: 0383-368740, Fax: 0383-368740 / **Prada Cesare M. Antonio**, Via Riviera 142, 27100, Pavia, Tel: 0382-525920, Fax: 0382-525920 / **S.A.R.E.L. Snc Di Giglia Mario**, Corso 30, 27029, Vigevano (Pv), Tel: 0381-344088, Fax: 0381-344088 / **S.T.A.R.T. Video Hi-Fi**, Via Orti Romani 16/A, 26100, Cremona, Tel: 0372-38731, Fax: 0372-38731 / **Salvadori Claudio**, Via Del Bosco 44, 21052, Busto Arsizio (Va), Tel: 0331-329973, Fax: 0331-628727 / **Service Tva Snc**, Via Vergnano 59, 25127, Brescia, Tel: 030-349885, Fax: 030-349885 / **Tecnovideo Snc**, P.Zza De Gasperi 28, 46100, Mantova, Tel: 0376-321554, Fax: 0376-321554 / **Teletecnica 2000**, Via Torino 21, 21013, Gallarate (Va), Tel: 0331-775519, Fax: 0331-775519 / **Test Tv Snc**, Via S. Altamura 10, 20148, Milano, Tel: 02-4035408, Fax: 02-48704889 / **Video Service Snc**, Via Locatelli 2, 24068, Seriate (Bg), Tel: 035-296883, Fax: 035-300076 / **C.A.T. Snc**, Via A. Cecchi 25, 61100, Pesaro, Tel: 0721-25608, Fax: 0721-25608 / **Digitecnica Di Moroni R. Snc**, Via Zuccarini, 1-Z.Baraccola, 60131, Candia (An), Tel: 071-2866067, Fax: 071-8046398 / **Marconi Lanfranco**, Via M.Bianco 10-Porto D'ascoli, 63039, S.Bened. D/Tronto, Tel: 0735-659230, Fax: 0735-751155 / **Pluritecnica Di Campitelli**, Via C. Ulpiani 5, 63100, Ascoli Piceno, Tel: 0736-342635, Fax: 0736-346405 / **S.A.T. Radio Tv**, Via D. Rossi 32-34, 62100, Macerata, Tel: 0733-231304, Fax: 0733-231304 / **Vitali Claudio**, Via Marconi 89, 60035, Jesi (An), Tel: 0731-59290, Fax: 0731-59290 / **Pesce Luigi**, Via Tiberio 74, 86100, Campobasso, Tel: 0874-63717 / **Alpilab Di Giordano**, Via S. Grandis 11, 12100, Cuneo, Tel: 0171-690384, Fax: 0171-648063 / **Arte E Tecnica Snc**, Via Falletti 22, 13900, Biella, Tel: 015-8496250, Fax: 015-8496250 / **Elektro Di Fiore F.**, Via Tripoli 91, 13100, Vercelli, Tel: 0161-250071, Fax: 0161-255843 / **F.G. Elettronica**, Via Sagra S.Michele 46, 10141, Torino, Tel: 011-796423, Fax: 011-796423

Guida Di Guida Alessio, Via Roggiolo 5, 28069, Treccate (No), Tel: 0321-71608, Fax: 0321-777003 / **Mantoan Dario**, Via Matteotti 69, 28062, Cameri (No), Tel: 0321-519078, Fax: 0321-519078 / **Siragusa E Roagna Sdf**, C.So Matteotti 41, 14100, Asti, Tel: 0141-531131, Fax: 0141-531131 / **Videotext**, P.Zza D.Alp.Cuneense 24, 12043, Canale (Cn), Tel: 0173-95878, Fax: 0173-979638 / **A.V.S. Snc**, Via N.Pompilio 61, 72100, Brindisi, Tel: 0831-560165, Fax: 0831-560165 / **Arnesano Faustino**, Via M.Moscardino 10, 73100, Lecce, Tel: 0832-318277, Fax: 0832-318277 / **C.Ass.Tec. Di Columella**, Via Mazzini 30, 71016, San Severo (Fg), Tel: 0882-226295, Fax: 0882-226295 / **Eletr.Serv. Di Marcuccio**, C.So Annibale 15/17, 74100, Taranto, Tel: 099-7721933, Fax: 099-7721933 / **Eltec Service Di Pepe G.**, Viale Ofanto 149-151, 71100, Foggia, Tel: 0881-685013, Fax: 0881-687041 / **Ingresso Fernando**, Via Biasco 15, 73100, Lecce, Tel: 0832-396466, Fax: 0832-392014 / **Marinelli Benedetto**, Via Dei Salici 14, 70051, Barletta (Ba), Tel: 0883-514054, Fax: 0883-527128 / **Massariello Agostino**, Via Numa Pompilio 65, 72100, Brindisi, Tel: 0831-521821, Fax: 0831-521821 / **Stear Snc Di Pici**, Via E.Perrone 16, 71100, Foggia, Tel: 0881-778483, Fax: 0881-778483 / **Video Serv. Marcantonio**, Via G.M. Giovane 47, 70124, Bari, Tel: 080-5618029, Fax: 080-5618029 / **Zetaclima Di Zumpano**, Via Molfetta 69, 70054, Giovinazzo (Ba), Tel: 080-3947952, Fax: 080-3947952 / **Sat Di Partipilo**, Via Borsellino E Falcone 17 Bis, 70100, Bari, Tel: 080-5022999, Fax: 080-5022992 / **Base Elettronica**, Via G. Currelli, S.N., 09170, Cristiano, Tel: 0783-310049, Fax: 0783-212081 / **Chip Elettronica S.R.L.**, Via Salvator Rosa 26, 09100, Cagliari, Tel: 070-521338, Fax: 070-506074 / **Co.Ri.Fr.El. 2 Snc**, Via Del Castagno Settore D, 07026, Olbia - Zona Cerasarda

Co.Ri.Fr.El. Snc, Via Monastir 112, 09122, Cagliari, Tel: 0789-9562105 / **Floris Sergio**, Via Mazzini 56, 09010, Gonnesa (Ca), Tel: 0781-45436, Fax: 0781-469198 / **G.S. Elettronica Di Porcu**, Via Della Resistenza 5, 08100, Nuoro, Tel: 0784-203084, Fax: 0784-203084 / **Hi-Fi Center**, Via Lucania 15, 07026, Olbia (Ss), Tel: 0789-22164, Fax: 0789-200366 / **Matta Paolo**, Via Risorgimento 166/A, 09134, Cagliari-Pirri, Tel: 070-520856, Fax: 070-524148 / **Videoelettronica Snc**, Via Torino 18, 07100, Sassari, Tel: 079-276616, Fax: 079-273239 / **A.T.El. Di G.Amico**, L.Go Scarlatti 30, 93100, Caltanissetta, Tel: 0934-591955, Fax: 0934-552999 / **A.V.S.**, Via Sassari, 2/C, 95100, Catania, Tel: 095-446696, Fax: 095-434337 / **Alamia Service**, C.So Pisani, 310/312, 90129, Palermo, Tel: 091-6570502, Fax: 091-6575761 / **Euroservice 2000**, Via Degli Atleti, 61/C, 91025, Marsala (Tp), Tel: 0923-956475, Fax: 0923-956475 / **Arte Tv E C. Snc**, Via G.Centorbi 17, 91026, Mazara Del Vallo, Tel: 0923-908160, Fax: 0923-670035 / **Centro Ass. Tec. Di Bacchi I.**, P.Za A. Giglia 40, 92026, Favara (Ag), Tel: 0922-420311, Fax: 0922-421545 / **Cuppari Electr.**, Via S.Agostino Is 265, 98100, Messina, Tel: 090-672064, Fax: 090-672065 / **Di Fonzo F.E Figli Snc**, Via Ruggero Loria 4/6, 90100, Palermo, Tel: 091-363578, Fax: 091-362853 / **Elettronica Di Tullio**, Via Carlentini 40/A, 96100, Siracusa, Tel: 0931-758602, Fax: 0931-758602 / **Tecnica Sud S.N.C.**, V.Le Regina Elena 225/227, 98100, Messina, Tel: 090-40037, Fax: 090-52831 / **Tecnico Siracusana**, V.P.Novelli 71, 96100, Siracusa, Tel: 0931-39440, Fax: 0931-36294 / **Torrisi Michele**, Via Novara 45, 95128, Catania, Tel: 095-445561, Fax: 095-448628 / **Vullo Michele**, Via Gorizia 16, 93100, Caltanissetta, Tel: 0934-551367, Fax: 0934-551367 / **A.T.E.S. Di Zappia L.**, Via Torino 3/A, 57124, Livorno, Tel: 0586-859566, Fax: 0587-859565 / **Belcari Nolberto**, Via J. Gagarin 70, 56012, Pisa, Tel: 0587-420273, Fax: 0587-420273 / **Centi Franco**, Via Dosio 83, 50142, Firenze, Tel: 055-710388, Fax: 055-710388 / **Cre Carradori Snc**, Via Dei Macelli 1, 51100, Pistoia, Tel: 0573-28284, Fax: 0573-324219 / **D'amicis Genaro**, Via P.Pisana 71, 57100, Livorno, Tel: 0586-400564, Fax: 0586-409724 / **Elettronica Rnp**, Via Romana 731, 55100, Lucca, Tel: 0583-956225, Fax: 0583-956225 / **Goti Arcangelo**, Via Magellano 42/A, 52100, Arezzo, Tel: 0575-900819, Fax: 0575-900819 / **Lab.Riparaz. Falchi M.**, Via A. Garibaldi 22-D, 57025, Piombino (Li), Tel: 0565-49400, Fax: 0565-227161 / **Lab.Tv Arrighi**, Via F.Lli Cervi 26/28, 50057, P.A Elsa Empoli(Fi), Tel: 0571-931327, Fax: 0571-931327 / **M2 Elettronica**, Via Danimarca 3, 58100, Grosseto, Tel: 0564-454571, Fax: 0564-454571 / **Na.To.Ma Snc**, Via Del Sabotino 13, 58100, Grosseto, Tel: 0564-456229, Fax: 0564-456229 / **Pa.Ri.El.S.**, Via B. Tolomei 9, 53100, Siena, Tel: 0577-51159, Fax: 0577-589454 / **Saec Di Coppa**, Via Degli Artigiani 36, 54100, Massa, Tel: 0585-251724, Fax: 0585791177 / **Tele Service Di Benvenuti**, Via F. Busoni 3/B, 50018, Scandicci, Tel: 055-753974, Fax: 055-7350267 / **Videoservice Di Genuardi**, Via Borgaccio 72, 53036, Poggibonsi (Si), Tel: 0577-983181, Fax: 0577-996382 / **Bardazzi Paolo**, Via

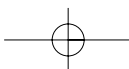

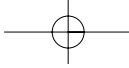

• SERVICE NIEDERLASSUNGEN • ADDRESSES D'ENTRETIEN • ONDERHOUDSADRESSEN • DIRECCIONES DE SERVICIO • INDIRIZZI DI SERVIZIO •

Forlanini 8dr, 500127, Firenze, Tel: 055-4376776, Fax: 055-431956 / **Dal Pozzo Enzo**, Via Barletta 8, 39100, Bolzano, Tel: 0471-913290, Fax: 0471-913290 / **Melone Giuseppe**, Via Zara 44, 38100, Trento, Tel: 0461-235166, Fax: 0461-267210 / **Sighel Mauro**, Via A. Volta 92, 38100, Trento, Tel: 0461-935919, Fax: 0461-935919 / **Tecnoservice Snc**, Via San Vigilio 64/B-C-D, 39100, Bolzano, Tel: 0471-289062, Fax: 0471-261559 / **Quondam**, Via Del Rivo 33, 05100, Terni, Tel: 0744-301512, Fax: 0744-301512 / **Tecnoconsult Elettronica**, Via Madonna Alta 185, 06100, Perugia, Tel: 075-5003089, Fax: 075-5003089 / **C.A.T. Di D'isanto**, C.So Ivrea 82/A, 11100, Aosta, Tel: 0165-364056, Fax: 0165-235910 / **Ass.Elefr.Campi Snc**, Via E.Reginato 87, 31100, Treviso, Tel: 0422-436245, Fax: 0422-435996 / **D.D. Assistenza Tecnica**, Via Mondin 11, 32100, Belluno, Tel: 0437-30240, Fax: 0437-939916 / **DI Service Di Dal Lago**, Via Giaretta 33, 36100, Vicenza, Tel: 0444-566662, Fax: 0444-966239 / **G.F.L. S.R.L.**, Via D. De Massari 10, 37045, Legnago, Tel: 0442-602020, Fax: 0442-602021 / **L'elettronica Piu' Snc**, Via Gaspare Campo 18, 45100, Rovigo, Tel: 0425-33221, Fax: 0425-33221 / **Pieffe Di Premier F.**, Via Zermanese 6/B, 31100, Treviso, Tel: 0422-321054, Fax: 0422-321054 / **Pierrezza Carlo**, Via Barroccio Dal Borgo 4, 35100, Padova, Tel: 049-8643266, Fax: 049-8643266 / **Sat Di Galber E C. Snc**, Via Catarineti 1/E, 37136, Verona, Tel: 045-509609, Fax: 045-509699 / **Speedy Service**, Viale Europa 42/B, 36016, Thiene Vi, Tel: 0445-368235, Fax: 0445-379028 / **Tecno Futura Di Rossi**, Via Dellinato 8 (Laboratorio), 35127, Camin (Pd), Tel: 049-9129469, Fax: 049-9126147 / **Video Service**, Via Vitruvio 11, 37100, Verona, Tel: 045-566299, Fax: 045-573865 / **Video Tv 17323**, Via S. Marco 1818, 30019, Stomarina (Ve), Tel: 041-5541675, Fax: 041-5541675 / **Vignando Luigino**, Via Dell'industria 18, 30020, Gruaro (Ve), Tel: 0421-74472, Fax: 0421-72923 / **Zaffalon Urbano**, Cas.Calle Corraz. 3849, 30122, Venezia, Tel: 041-2750670, Fax: 041-2757273 / **Ecoservice Srl**, Via Buffolara 68/A, 43100, Parma, Tel: 0521/987402, Fax: 0521/987402 / **Novatecnica Snc**, Via Giovanale, 78/A - Viserba Di Rimini, 47037, Rimini / **Reat Srl**, Via Giardini Nord 8, 41043, Formigine (MO), Tel: 059-557168, Fax: 059-573517 / **Tecnoservice.Com**, Via Serenari, 28/C, 40100 Castelmaggiore (BO), Tel: 051-6321343, Fax: 051-6320781 / **Radiotecnica 96 Di Fattorini**, Via A. Cantore, 14, 33040 Povoletto (UD), Tel: 0432-666797, Fax: 02-700425181 / **Panaservice**, Via S.Sotero, 36, 00165 Roma, Tel: 06-6380516, Fax: 06-6380973 / **Michelis Sandro**, Via Giannetti, 8/10, 18100 Imperia, Tel: 0183-275891, Fax: 0183-275891 / **Reat Di Frisina**, C.So Unione Sovietica, 584, 10135 Torino, Tel: 011-3979817, Fax: 011-3979817 / **Video Tecnica Di Rotulo**, Via Dante, 87/89, 92100 Agrigento, Tel: 0922-25183, Fax: 0922-20117 / **DBS Elettronica Di Aldovardi**, Via Simon Musico, 2/C, 54100 Massa, Tel: 0585-489893, Fax: 0585-886122

ESPAÑA

En caso de una reclamación con vuestra SHARP Microwave, preguntan por favor la casa dónde han comprado su máquina o infórmanse en una de las SHARP Service casas siguientes.

Lavison, C.B., 972/ 23.01.22, Cl Montseny 35, Girona, Girona / **Videoolor**, 93/ 454.99.08, Cl Villarroel 44, Barcelona, Barcelona
Argi Giltz, 94/ 443.77.93, Cl Autonomia 15, Bilbao, Vizcaya / **Estarlich Pradas Vicente**, 93/ 766.22.33, Cl Industria 131, Calella, Barcelona / **Sabe Electronica**, 964/ 21.52.65, Cl Joaquin Costa 46, Castellon, Castellon / **Teknibat Electronica**, 943/ 70.24.37, Cl Zezenbide 4, Eibar, Guipuzcoa / **Electronica Gomez**, 96/ 546.75.81, Cl Baltasar Tristany 100, Elche, Alicante / **Ramon Villaret De Gea**, 93/ 798.02.48, Cl Moli De Vent 21, Mataro, Barcelona / **Irtesa Electronica**, 971/ 20.47.02, Cl Jaume Ferran 72 Bjos, Palma De Mallorca, Balears (Mallorca) / **A. T. Pamplona**, 948/ 24.19.50, Cl Julian Gayarre 1, Pamplona, Navarra / **Ce.Va.Sat**, 93/ 710.76.13, Ps Rubio I Ors 105, Sabadell, Barcelona / **Servicios Electronicos**, 96/ 340.20.34, Cl Doctor Oloriz 3, Valencia, Valencia
Laurea S.A.T., 93/ 889.02.48, Cl Guillerries Bis 20, Vic, Barcelona / **Merino Nicolas Jose A.**, 945/ 25.18.92, Av Judizmendi 24, Vitoria-Gasteiz, Alava / **Ce. Va. Sat, S.C.**, 93/ 785.51.11, Cr Matadepera 87, Terrassa, Barcelona / **Unitec**, 948/ 82.74.34, Cl Fuente Canonigos 5, Tudela, Navarra / **Euro Tecnic Electronica**, 977/ 32.24.89, Cl Lepanto 16-18, Reus, Tarragona / **Servitele**, 94/ 444.89.02, Cl Autonomia 24 Galerias, Bilbao, Vizcaya / **Satel**, 972/ 26.55.19, Ps De Barcelona 12, Olot, Girona
Ielsa, C.B., 973/ 24.71.27, Cl Tarragona 40, lleida, lleida / **Estudios 3, C.B.**, 943/ 45.37.97, Pz De Los Estudios 3, San Sebastian, Guipuzcoa / **Monje Ureña Manuel**, 972/ 70.25.52, Cl Sant Quinti 33, Ribes De Freser, Girona / **Cristel**, 973/ 27.08.26, Cl Vallcalent 32, lleida, lleida / **Teleservicio**, 974/ 31.34.44, Cl Estadilla 6, Barbastro, Huesca / **Insat, Cb**, 971/ 36.53.18, Cl Pintor Calbo 30, Mahon, Balears (Menorca) / **Electronica S. Torres**, 977/ 21.21.48, Cl Ernest Vilches 4-B L2, Tarragona, Tarragona / **Asiste, S.L.**, 964/ 21.57.69, Av De Valencia Nave 19, Castellon, Castellon / **Sonovision, C.B.**, 978/ 60.11.74, Cl Abadia 5, Teruel, Teruel / **Buira Tecnic's**, 977/ 66.04.37, Cl San Javier 55, El Vendrell, Tarragona / **Tecnik's, S.C.P.**, 93/ 630.11.20, Cl Joan Bardina 32, Sant Boi De Ll., Barcelona / **Eldo**, 93/ 872.85.42, Cl Bruch 55, Manresa, Barcelona / **Teleservicio**, 974/ 22.01.39, Cl Tenerias 20, Huesca, Huesca / **Servinters, S.C.C.L.**, 93/ 389.44.60, Pz Casagemes 20, Badalona, Barcelona / **Elec.Safont Montraveta, Sc**, 93/ 821.30.03, Cl Gral. Manso Sola 31, Berga, Barcelona / **Tecno Hogar**, 96/ 286.53.35, Cl Dos De Mayo 41, Gandia, Valencia / **Reparaciones Ortega**, 971/ 39.01.55, Cl Via Punicca 33, Ibiza, Balears (Ibiza) / **Telesonic**, 974/ 36.32.97, Cl Teruel 6, Jaca, Huesca / **Antonio Monleon, S.L.**, 96/ 334.55.87, Av De La Plata 91, Valencia, Valencia / **Electronica Las Heras**, 96/ 238.11.14, Cl Jose Irazo 6, Ontinyent, Valencia / **Telecom Electronica**, 96/ 539.50.21, Cl Hernan Cortes 8, Elda, Alicante / **Audio Imagen**, 971/ 31.46.59, Cl Jose Riquer llobet 8, Ibiza, Balears (Ibiza) / **4 En 1 Reparaciones**, 93/ 430.97.26, Cl Taquigrafia Marti 19, Barcelona, Barcelona / **Sac-2, S.C.P.**, 93/ 331.77.54, Cl Riera Blanca 113, Barcelona, Barcelona / **Martorell Altes Francisco**, 977/ 75.32.41, Cl Roseta Mauri 10, Reus, Tarragona / **Cinca Monterde Antonio**, 976/ 31.69.65, Cl Via Universitat 52, Zaragoza, Zaragoza / **Electronica Josep**, 977/ 88.04.41, Ctra. Igualada 29 Bjos, Sta. Coloma Queralt, Tarragona / **Fermo**, 93/ 465.22.00, Av Morera 5, Badalona, Barcelona / **Negredo Martin Daniel**, 94/ 411.22.82, Cl Padre Pernet 8, Bilbao, Vizcaya / **Collantes Martin Onofre**, 94/ 483.21.22, Cl Ortuño De Alango 7, Portugaleta, Vizcaya / **Riera Daviu**, 972/ 50.32.64, Cl Torras Y Bages 19, Figueres, Girona / **Envisa Electronic, S.L.**, 96/ 241.24.87, Cl General Espartero 9, Alzira, Valencia / **F.Carceller-F.Cervera, C.B.**, 964/ 45.44.65, Cl Carrero 29, Vinaros, Castellon / **Eurosat, S.L.**, 96/ 525.80.40, Cl Montero Rios 33, Alicante, Alicante / **Teelco**, 93/ 805.11.90, Av Balmes 90, Igualada, Barcelona / **Audiovision**, 93/ 385.78.08, Cl Mare Deu Montserrat 22, Sta.Coloma Gramanet, Barcelona / **Tele-Color**, 96/ 585.24.60, Cl Del Vent 9, Benidorm, Alicante / **Tecno Serveis Mora**, 977/ 40.08.83, Cl Pau Picasso 1, Mora D'ebre, Tarragona / **Electronica Moncho**, 96/ 287.23.29, Cl Pare Pascual Catala 5, Gandia, Valencia / **Electronica Mateos**, 93/ 849.28.77, Cr De Caldas (Bajos) 76, Granollers, Barcelona / **Electron. Pons Gomila Sa**, 971/ 37.22.76, Cr Nueva 162, Alayor, Balears (Menorca) / **Antonio Robles Sanchez**, 93/ 872.55.41, Cl Sant Bartomeu 42, Manresa, Barcelona / **Top Electronica**, 93/ 890.35.91, Cl Misser Rufet 4 Bjos, Vilafranca Penedes, Barcelona / **Totvisio Electronica S.L.**, 93/ 873.88.81, Pj Ferrer 14, Manresa, Barcelona / **Satuf**, 973/ 50.08.48, Av Raval Del Carme 12, Tarrega, Lerida / **Fix Servicio Tecnico**, 93/ 675.59.02, Cl Valles 88, Sant Cugat Valles, Barcelona / **Selecco S.L.**, 977/ 70.00.12, Cl Calderon De La Barca 11, Amposta, Tarragona / **Instalaciones Maes, S.L.**, 971/ 27.49.47, Cl Son Nadal 63, Palma De Mallorca, Balears (Mallorca) / **Sertecs, S.C.**, 977/ 22.18.51, Cl Caputxins (Bajos) 22, Tarragona, Tarragona / **Sonitec Electronica, C.B.**, 93/ 815.74.44, Cl Aigua 143, Vilanova I Geltru, Barcelona / **Aragon Televideo, S.C.**, 976/ 32.97.12, Cl Batalla Clavijo 18, Zaragoza, Zaragoza / **Jose Marques Anglada, S.L.**, 971/ 38.54.54, Cl Lepanto 19, Ciudadela, Balears (Menorca) / **Electronica Alcañiz S.L.**, 979/ 87.07.94, Cl Carmen 21, Alcañiz, Teruel / **Teleservicio Bajo Aragon**, 978/ 87.08.10, Cl Romualdo Soler 4, Alcañiz, Teruel / **Reparaciones Urruti S.L.**, 943/ 45.84.10, Ps Aintzieta 32, San Sebastian, Guipuzcoa / **Reparaciones Pilsa S.C.**, 972/ 20.66.96, Cl J. Pascual I Prats 8, Gerona, Gerona / **Electro Servei C.B.**, 977/ 51.04.42, Ps Moreira 10, Tortosa, Tarragona / **Electronica Santa Pola**, 96/ 571.25.58, Cl Orihuela 43, Torrevieja, Alicante / **Electronica Loguard**, 977/ 32.38.04, Cl Vapor Vell 17, Reus, Tarragona / **A.B.R. Electronica S.L.**, 977/ 50.21.20, Cl Calderon La Barca 3, Roquetes, Tarragona / **La Clinica Del Electron.**, 93/ 236.44.11, Cl Balmes 160, Barcelona, Barcelona /

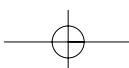

· SERVICE NIEDERLASSUNGEN · ADDRESSES D'ENTRETIEN · ONDERHOUDSADRESSEN · DIRECCIONES DE SERVICIO · INDIRIZZI DI SERVIZIO ·

Angel Avellan Puig, 965/ 21.32.55, Cl Poeta Quintana 13, Alicante, Alicante / **Pulgarc I Edo S.L.**, 93/ 436.44.11, Cl Castillejos 333, Barcelona, Barcelona / **A.E. De Consumo**, 96/ 552.32.35, Cl Peru 42, Alcoy, Alicante / **Unisat**, 96/ 674.11.94, Cl Duque De Tamames 9, Orihuela, Alicante / **Electro-Sat**, 971/ 32.27.62, Cl Eivissa 12-16, S. Francesc De Formentera, Baleares (Formentera) / **Garman C.B.**, 91/380.33.49, Cl Carlos Sole 38 Local, Madrid, Madrid / **Electronica Bote**, 924/ 22.17.40, Pz Portugal 2, Badajoz, Badajoz / **Ruiz Garcia Jose**, 927/ 22.48.86, Cl Ecuador 5-B, Caceres, Caceres / **Electronica Edimar**, S.A, 98/ 535.34.51, Cl Cangas De Onis 4, Gijon, Asturias / **Servicio Tecnico**, 956/ 87.07.05, Cl Divina Pastora E-1 L-4, Jerez La Frontera, Cadiz / **Electronica Torres**, S.C., 941/ 24.76.15, Av Navarra 14, Logroño, La Rioja / **Cañedo S.T.**, 98/ 522.29.68, Cl Otero, S/N C. Cial, Oviedo, Asturias / **Electronica Javier**, 979/ 75.03.74, Av Castilla 77, Palencia, Palencia / **Teleservicios**, 983/ 30.92.61, Cl Esgueva 6, Valladolid, Valladolid / **Central De Servicios**, 986/ 37.47.45, Cl Asturias (Bajo) 10, Vigo, Pontevedra / **Dueñas Cal As Teodoro**, 957/ 26.35.06, Cl Hermano Juan Fdez 15, Cordoba, Cordoba / **Telejara**, 959/ 22.60.74, Pol. Polirrosa C/A Nave-27, Huelva, Huelva / **Alejandro Hernandez**, 978/ 60.85.51, Rb San Julian 59, Teruel, Teruel / **Caro Porlan Raimundo**, 968/ 46.18.11, Cl Jose Mouliacia 45, Lorca, Murcia / **Daniel Serrano Labrado**, 920/ 37.15.16, Cl Jose Gochicoa 16, Arenas De S.Pedro, Avila / **Electronica Fouces**, 982/ 40.24.38, Cl Benito Vicetto 34, Monforte De Lemos, Lugo / **Televideo**, 950/ 40.18.63, Cl Velazquez 7 Local-A, Adra, Almeria / **Reg., C.B.**, 968/ 51.00.06, Cl Ramon Y Cajal 27, Cartagena, Murcia / **Electronica Rivas**, 925/ 80.55.46, Cl Barrio San Juan 1, Talavera La Reina, Toledo / **Antonio Cazorla Luque**, 952/ 36.16.02, Cl Ciudad De Andujar 2, Malaga, Malaga / **Telson**, 987/ 21.25.18, Cl Batalla Clavijo 2, Leon, Leon / **Alvarez Olivares Casilda**, 98/ 522.37.39, Cl San Jose 12, Oviedo, Asturias / **Electronica Jumar**, 953/ 26.17.08, Cl Goya (Las Flores) 1, Jaen, Jaen / **Video Taller, S.C.**, 952/ 54.23.95, Edif. La Noria B Bjos-5, Torre Del Mar, Malaga / **Top Service**, 941/ 13.50.35, Cl Achutegui De Blas 17, Calahorra, La Rioja / **Electroservicios Seba, C.B.**, 968/ 29.85.93, Cl Isaac Albeniz 4 Bjos, Murcia, Murcia / **Garcia Quintela Arturo**, 981/ 70.21.07, Cl Xoane, Carballo, La Coruña / **Tv Video Jimenez, S.L.**, 967/ 34.04.43, Cl Juan Xxiii 38, Almansa, Albacete / **Electronica Mas**, 947/ 31.49.94, Cl Alfonso Vi 6, Miranda De Ebro, Burgos / **Manuel Mato Señaris**, 981/ 53.71.14, Cl Silvouta-Pedra Da, Santiago Compostela, La Coruña / **Electronica Gredos**, 920/ 22.48.39, Cl Eduardo Marquina 24, Avila, Avila / **Jimenez Almohalla Miguel**, 920/ 25.08.76, Cl Jacinto Benavente 1, Avila, Avila / **Jiellsa**, 96/ 546.14.27, Cl Doctor Ferran 97, Elche, Alicante / **New Meresa**, 972/ 30.44.54, Cl Surera Bertran 23, Palafregell, Girona / **Arsenio Sanchez**, C.B., 927/ 41.11.21, Cl Tornavacas 9, Plasencia, Caceres / **Electronica Barajas**, 91/ 305.48.90, Pz Del Jubilado 8, Barajas, Madrid / **Gallardo Alonso Miguel**, 958/ 67.64.81, Cl Carmen 104, Benalua De Guadix, Granada / **Aguado Gil Roberto**, 941/ 25.25.53, Av Viana 10, Logroño, La Rioja / **Zener Electronica**, 981/ 22.07.00, Cl Ronda De Monte Alto 15, La Coruña, La Coruña / **Electronica Garman, C.B.**, 91/ 368.01.79, Cl Mandarina 15, Madrid, Madrid / **Jose Borja Y Jose Arana**, 956/ 66.60.53, Cl San Antonio 31, Algeciras, Cadiz / **Servisuel, Edif. La Union**, 952/ 46.90.28, Cm De Las Cañadas Lc 2, Fuengirola, Malaga / **S.T. Mendez**, 981/ 27.52.52, Cl Gil Vicente 13, La Coruña, La Coruña / **Electronica Triana**, 95/ 433.83.03, Cl Evangelista 69-71 L-25, Sevilla, Sevilla / **Electronica Ansar**, 91/ 460.47.45, Cl Tomasa Ruiz 4, Madrid, Madrid / **Electronica Castilla**, 981/ 32.14.09, Cr Castilla 377-Bis Bjos, Ferrol, La Coruña / **Tec-Norte**, 91/851.63.47, Cl Santiago Apostol 5, Collado Villalba, Madrid / **Electronica Arellano**, 926/ 54.78.95, Cl Lorenzo Rivas 14, Alcazar De San Juan, Ciudad Real / **Fernandez Gonzalez Jose**, 988/ 23.48.53, Av Buenos Aires 75 Bjos, Orense, Orense / **Visatel**, 968/24.16.47, Cl Torre Alvarez S/N, Murcia, Murcia / **Electronica Fe-Car, S.L.**, 925/ 21.21.45, Av Santa Barbara 30, Toledo, Toledo / **Salvador Rodriguez, C.B.**, 987/ 40.36.02, Cl Ortega Y Gasset 24, Ponferrada, Leon / **Juan Gomez Orellana**, 956/ 46.25.01, Cl Fco.Fdez.Ordoiz 5 LD, Ubrique, Cadiz / **Abril Sanchez Valentin**, 959/ 10.60.41, Cl Cadiz 2, Cala, Huelva / **Vilchez Vilchez Rafael**, 958/ 60.06.50, Cl Amadeo Vives 9, Motril, Granada / **Electro Servicios Plaza**, 968/ 28.45.67, Cl Gomez Cortina 10, Murcia, Murcia / **Telepal**, 95/ 464.95.80, Cl Julio Verne 49, Sevilla, Sevilla / **Auvitel, S.L.**, 95/ 427.57.07, Cl Virgen De Africa 20, Sevilla, Sevilla / **Electronica Wenceslao**, 958/ 81.16.16, Cl Fontiveros 42, Granada, Granada / **Zabala Vazquez Jose**, 927/ 57.06.13, Cl Del Agua 39, Losar De La Vera, Caceres / **Santiago Valderrey**, 98/ 563.18.61, Cl Dr. Venancio Mtez. 7, Navia, Asturias / **Variosat, S.L.**, 91/ 662.04.68, Cl Isla De Corcega 24, Alcobendas, Madrid / **Teco**, 975/ 22.61.25, Cl Antolin De Soria 10, Soria, Soria / **Imason**, 986/ 84.16.36, Cl Loureiro Crespo 43, Pontevedra, Pontevedra / **Telesonid Huelva, S.C.A.**, 959/ 24.38.60, Cl Fco.Vazquez Limon 4, Huelva, Huelva / **Guijo S.T.**, 921/ 42.94.18, Cl Teofilo Ayuso 2 Local, Segovia / **Almat Electronica**, 923/ 22.45.08, Cl Galileo 21, Salamanca, Salamanca / **Electronica Seyma**, 942/ 23.69.19, Cl Del Monte 69 C Bjos, Santander, Cantabria / **Asist. Tecnica Marcos**, 983/ 29.78.66, Cl Pio Del Rio Ortega 2-4, Valladolid, Valladolid / **Tecnicas Marvi S.L.**, 949/ 23.27.63, Pz Capitan Boixareu 51, Guadalajara, Guadalajara / **Bandin Audio**, 981/ 86.60.23, Cl Rua Arcos Moldes 2 B-3, Rianxo, La Coruña / **Televexo S.L.**, 982/58.18.57, Cl Nosa Sra. Do Carmem 82, Burela, Lugo / **Digmat Electronica**, 958/ 70-04-52, Av Jose De Mora 16, Baza, Granada / **Serpriego S.L.**, 957/ 54.15.11, Cl San Luis 4 Bjo. Izda., Priego De Cordoba, Cordoba / **Instalacion Martin**, 669/ 85.98.80, Cl Alicante 11 (1ª - C), Getafe, Madrid / **Servirap**, 950/ 27.40.67, Cl Angel Ochotonera 11, Almeria, Almeria / **Tecnihogar**, 956/ 28.10.82, Cl Tolosa Latour 19, Cadiz, Cadiz / **Cayro**, 957/ 26.35.06, Cl Hermano Juan Fdez. 15, Cordoba, Cordoba / **Microm Electronica**, 957/ 23.02.22, Av Aeropuerto 2, Cordoba, Cordoba / **Fermasa**, 958/ 25.64.77, Cl Azorin 7, Granada, Granada / **Servigon**, 958/ 20.52.81, Cl Hospital De La Virgen 22, Granada, Granada / **Relegra S.L.**, 958/ 27.24.50, Cl Dr.Gomez Roman 5, Granada, Granada / **Servicosta**, 958/ 63.11.43, Pz Dr. Alvarez Riosol 1, Almuñecar, Granada / **Airsex Huelva**, 959/ 22.88.13, Ps De La Glorieta 6, Huelva, Huelva / **Electro Sur**, 959/ 29.06.15, Cl Alonso De Ercilla 23, Huelva, Huelva / **Climaire Plus**, 95/ 234.50.36, Cl Guaro 4, Malaga, Malaga / **Covitel**, 95/ 231.62.50, Cl Ceramistas 8, Malaga, Malaga / **Luis Rivas Caldas**, 95/ 451.73.55, Cl Febo 16, Sevilla, Sevilla / **Intersat Sevilla**, 95/ 443.02.26, Cl Beethoven 5, Sevilla, Sevilla / **Frilar**, 95/ 492.14.44, Pol. Indust. Navisa C/A 47, Sevilla, Sevilla / **Pedro L. Villagrasa**, 976/ 37.10.20, Cl Augusto Borderas 3-5 Lzq., Zaragoza, Zaragoza / **G.A.M.I.F.E.L.**, 98/ 528.43.60, Cl Ricardo Montes 6, Oviedo, Asturias / **Amsa**, 971/ 27.27.57, Cl Isidoro Antillon 97, Palma De Mallorca, Baleares / **Teclurami Menorca**, 971/ 35.28.02, Cl Pintor Calbo 57, Mahon, Baleares / **David Torregrosa Jorda**, 965/ 33.43.06, Cl Terrasa 6, Alcoy, Alicante / **Electronica Bersabe**, 95/ 483.33.93, Pasaje Merinos 62 A, Ecija, Sevilla / **Novomom-Sat**, 956/ 40.12.09, Pol. Urbisur, Jorge Juan 4, Chiclana De La Frontera, Cadiz / **Video Service Electronic**, 91/ 880.27.87, Cl Era Honda 9, Alcalá De Henares, Madrid / **Servei Tecnici Ferrer**, 93/ 710.51.38, Cl Sarda 37, Sabadell, Barcelona / **Fred Vilafranca**, 93/ 890.48.52, Cl Progres 42, Vilafranca Del Penedes, Barcelona / **Domca**, 973/ 24.74.46, Cl Tarragona 29, Lerida, Lerida / **Mañe Grifolls**, 977/ 69.04.39, Cl Jesus 21, Calafell, Tarragona / **Ramsat**, 981/ 74.74.61, Av Finisterre 117-B, Cee, La Coruña / **Victor Perez Quintela**, 981/ 58.43.92, Cl Entrerios 35, Santiago De Compostela, La Coruña / **Antonio Rodriguez Alvarez**, 988/ 22.40.98, Cl Cabeza De Manzaneda 7, Orense, Orense / **Ugenasa**, 91/ 611.52.51, Cl La Canaleja 4, Alcorcon, Madrid / **Javier Acevedo**, 91/ 843.01.58, Pz Mayor 5, Torrelaguna, Madrid / **Tecniblan**, 968/ 29.39.99, Cl Jose Javier 1, Murcia, Murcia / **Angel Lopez Alcaraz**, 968/ 29.39.10, Cl Sierra Del Espartal 6 (Edif. Ana), Murcia, Murcia / **Elbeservi, S.A.**, 91/ 386.27.11, Cl Dr.R. Castroviejo 19, Madrid, Madrid / **Televideo Nervion**, 95/ 458.10.66, Cl Juan Curiel 22, Sevilla, Sevilla / **Servicio Tecnico Ponce**, 950/ 13.28.37, Plg Ps Marítimo E-Europa 1, Garrucha, Almeria / **Marcial Lagoa Gonzalez**, 924/ 49.03.33, Cl Ramon Y Cajal 7, Olivenza, Badajoz / **Electronica Gonzalez**, 953/ 50.33.82, Corredera San Bartolome 11, Andujar, Jaen / **Sat Tv Video Vazquez**, 926/ 42.09.93, Cl Aduana 3, Puertollano, Ciudad Real / **C.E. Vilanovense C.B.**, 924/ 84.59.92, Cl Camino Magacela 4 Local-5, Villanueva Serena, Badajoz / **Electronica Sales**, 957/ 66.09.04, Cl Andalucia 11, Aguilar Frontera, Cordoba / **Astusetel S.L.**, 98/ 539.10.11, Cl Ceja Bermudez 9, Gijon, Asturias / **niservic Electronica**, 953/ 75.14.19, Cl Goya 1 Bjos, Ubeda, Jaen / **Radio Sanchez C.B.**, 927/ 32.06.88, Av De Miajadas S/N, Trujillo, Caceres / **Asturservice**, 98/ 556.83.87, Cl Sanchez Calvo 6 Bjos., Aviles, Asturias / **Electrodiaz S.L.**, 926/ 32.23.24, Cl Buensuceso 10, Valdepeñas, Ciudad Real / **Tele-Nueva**, 926/ 50.59.96, Cl Campo 56, Tomelloso, Ciudad Real / **Juan Morillon Del Corro**, 98/ 567.40.24, Av De Gijon 19, La Felguera/Langreo, Asturias / **Electronica**

• SERVICE NIEDERLASSUNGEN • ADDRESSES D'ENTRETIEN • ONDERHOUDSADRESSEN • DIRECCIONES DE SERVICIO • INDIRIZZI DI SERVIZIO •

Centeno S.L., 924/ 57.53.08, Av Del Zafra 1, Puebla Sancho Perez, Badajoz / **Electronica Penelo**, 982/ 21.47.43, Cl Serra Gañidoira 63, Lugo, Lugo / **Galan Sat S.L.**, 956/ 20.14.17, Cl Cruz Roja Española 11, Cadiz, Cadiz / **Galan Sat S.L.**, 956/ 83.35.35, Cl Factoria Matagorda 52, Puerto Real, Cadiz / **Servitec Burgos S.L.**, 947/ 22.41.68, Cl Lavaderos 7-9, Burgos, Burgos / **Electronica Garcia**, 969/ 22.24.83, Cl Ramon Y Cajal 17, Cuenca, Cuenca / **Indalecio Amaya Sanchez**, 924/ 66.47.01, Cl Carreras 11, Almendralejo, Badajoz / **Lavison Electronica S.L.**, 957/ 75.01.75, Cm De La Barca 3, Cordoba, Cordoba / **Antonio Gonzalez Esquinas**, 957/ 57.10.50, Cl Gral Primo Rivera 61, Peñarroya, Cordoba / **Electronica Jopal S.L.**, 925/ 25.04.42, Av Santa Barbara S/N, Toledo, Toledo / **Juman**, 967/ 22.40.78, Cl Ejercito 1, Albacete, Albacete / **Anuma**, 953/ 69.70.41, Cl Paredon 24, Linares, Jaen / **Electro 93 S.L.**, 95/ 472.37.16, Cl Melliza 1, Dos Hermanas, Sevilla / **Sonivitel S.L.**, 950/ 22.97.55, Cl Poeta Paco Aquino 51, Almeria, Almeria / **Sial-Alvimo S.L.**, 986/ 29.93.01, C/ C. Torrecedeira 92 Bjos, Vigo, Pontevedra / **Patricio Electronica**, 924/ 33.04.13, Cl Reyes Huertas 7, Merida, Badajoz / **Electronica Cambados**, 986/ 50.83.27, Cl Camilo Jose Cela 13, Vilagarcia Arousa, Pontevedra / **Electronica Vitelson**, 983/ 80.43.56, Pz Del Mercado 9, Medina Del Campo, Valladolid / **Megatecnica Extremeira**, 958/ 26.06.01, C./Mozart L2 Ed.Granate, Granada, Granada / **R.T.V. Blanco**, 980/ 51.14.41, Cl Eduardo Julian Perez 9, Zamora, Zamora / **Rafael Gomez Yelo**, 968/ 26.14.67, Ps Corbera 17, Murcia, Murcia / **Prosat**, 987/ 20.34.10, Pz Doce Martires 5, Leon, Leon / **Electro Anaya**, 925/ 48.09.81, Cl Vertedera Alta 14, Consuegra, Toledo / **S.A.T. Juan-Manuel**, 98/ 581.22.48, Cl Uria 60, Cangas De Narcea, Asturias / **Manuel Alea Villa**, 98/ 592.26.40, Cl llano Morgolles S/N, Cangas De Onis, Asturias / **Electro Himega, S.A.**, 953/ 24.22.56, Cl Adarves Bajos 4-C, Jaen, Jaen / **Electrogan**, 956/ 87.07.05, Cl Pagador 31, Pto. Sta. Maria, Cadiz / **Servitel**, 956/ 33.76.55, Cl Porvenir 11 Local, Jerez La Frontera, Cadiz / **Lara Technitel**, 926/ 21.17.87, Cl De La Jara 1, Ciudad Real, Ciudad Real / **Parreño**, 967/ 22.62.49, Cl Santiago Rusiñol 50, Albacete, Albacete / **Victor Quiles Parra**, 926/ 32.54.38, Cl Jose Ramon Osorio 57, Valdepeñas, Ciudad Real / **S.T.C.**, 696/ 20.14.08, Cl Nord 24, Palafrugell, Girona / **Ferreteria Toledano**, 949/ 23.02.61, Cl Ejercito 17 A, Guadalajara, Guadalajara / **Satelec**, 926/ 22.01.55, Cl Libertad 13 L-1, Ciudad Real, Ciudad Real / **Reparaciones San Segundo**, 920/ 22.33.21, Cl Soria 6, Avila, Avila / **Tecnyser Electro**, 987/ 22.77.87, Cl Relojero Losada 25, Leon, Leon / **Multiservicio Palencia**, 979/ 74.53.80, Cl Cardenal Cisneros 20, Palencia, Palencia / **J. Daniel Martinez**, 923/ 19.16.10, Cl Abraham Lacut 11-15, Salamanca, Salamanca / **Jesus Alburquerque**, 983/ 24.62.26, Cl Vinos Ribera Del Duero 10, Valladolid, Valladolid / **Domotica**, 93/ 408.66.22, Av Diagonal 296, Barcelona, Barcelona / **Salja & Mat**, 93/ 668.13.61, Cl La Raseta 15 L-3, Molins De Rey, Barcelona / **Alameda Barcelo 46**, 952/ 32.00.77, Av Velazquez 5, Malaga, Malaga / **Fermafrio**, 956/ 28.10.82, Pz España 1, Cadiz, Cadiz / **Elotronic**, 968/ 46.16.22, Pz Don Juan Moreno 8, Lorca, Murcia / **Electro Reparaciones 2000**, 948/ 26.79.12, Cl Monasterio Fitero 26, Pamplona, Pamplona / **Telnor**, 94/ 417.04.97, Pz Juanene 5 Tras., Erandio, Bilbao / **Instalacant**, 96/ 525.93.55, Cl Daya Vieja S/N Local 7, Alicante, Alicante / **Airnet**, 96/ 533.17.53, Cl Oliver 35, Alcoy, Alicante / **Arcadio Martinez**, 96/ 585.49.17, Cl Almudena 6, Benidorm, Alicante / **Joaquin A. Lon Jaen**, 96/ 578.67.50, Cl Patricio Ferrandiz 66, Denia, Alicante / **Trinitario Gea**, 96/ 545.56.25, Cl Jaime Pomares Javaloyes 47, Elche, Alicante / **Jose A. Patiño Villena**, 96/ 571.74.29, Cr De Bigastro 1, Orihuela, Alicante / **Electroservicos Plaza**, 96/ 828.45.67, Pz Santiago 5, Orihuela, Alicante / **E.Electrosax**, 96/ 547.42.32, Cl Rio Turia 1, Sax, Alicante / **Vensat Reparaciones**, 964/ 20.57.12, Cl Pintor Lopez 43, Castellon, Castellon / **Electronica Bg**, 952/ 78.50.09, Cl Andalucia 2, San Pedro De Alcantara, Malaga / **Servimart**, 964/ 51.32.05, Av Corts Valencianes 8, Burriana, Castellon / **Tefrival**, 96/ 333.19.00, Av Ausias March 6, Valencia, Valencia / **Mª Jesus Fernandez Pinilla**, 96/ 329.67.29, Cl Castellon De Rugat 8-S, Valencia, Valencia / **Angel Rodero Bellow**, 926/ 51.52.76, Cl Asturias 26, Tomelloso, Ciudad Real / **Climatec**, 652/ 79.03.60, Cl Pozo 3 4º A, Puertollano, Ciudad Real / **Antonio Jover Torregrasa**, 607/ 61.77.99, Cl Espronceda 12 Entlo. Izqda., Alicante, Alicante / **Feliu Canalias**, 972/ 73.01.72, Cl Major 26, Campdevanòl, Girona / **A.T. Tv. Video**, 965/ 80.02.31, Av De La Constitucion 185 D, Villena, Alicante / **Servicio Tecnico Pasfer**, 696/17.86.458, Av Arcadio Pardiñas 77, Burela, Lugo

SWITZERLAND

Sharp Electronics AG, Langwiesenstrasse 7, 8108 Dällikon, Tel: +41 1 846 61 11.

SWEDEN

Vid förfrågningar angående din mikrovågsugn var vänlig kontakta din återförsäljare eller någon av Sharps representanter **Centralservice Umeå**, Formvägen 8, 90621 Umeå, Phone: 090-125001, Fax: 090-131135 / **MN Elektronikservice AB**, Flygplatsinfarten 10A, 161 11 Bromma, Phone: 08-6275900, Fax:08-6275160 / **Jönköpings Antenn & TV Service**, Fridhemsvägen 20, 553 02 Jönköping, Phone: 036-161690, Fax: 036-160211 / **Ratronik Radio & TV Service**, Nordlandergatan 15, 931 32 Skellefteå, Phone: 0910-17305, Fax: 0910-16844 / **Tomi Elektronik AB**, Bäckvägen 90, 126 47 Hägersten, Phone: 08-186170, Fax: 08-186175 / **Tretronik**, Östermovägen 33, 854 62 Sundsvall, Phone: 060-155925, Fax: 060-173690 / **TV-Trim Service AB**, S:T Pauligatan 37, 416 60 Göteborg, Phone: 031-847200, Fax: 031-847500

NORWAY

Finn Clausen AS, Postbox 274, No-0511 Oslo, Phone: 47-22635000, Fax: 47-22646655
Norsk Elektronik senter, Postbox 13, No-2007 Kjeller, Phone: +47-63804500, Fax: +47-63804501

ICELAND

Braedurnir Ormsson Ltd, PO box 8790, IS-128 Reykjavik, Phone: +354-5332800, Fax: +354-5332810
Hjólmtækni Ehf, Skeifar, IS-108 Reykjavik, Phone: +354-5332150, Fax: +354-5332151

DENMARK

Sö Höyem AS, Büllowsvej 3, DK-1870 Fredriksberg C, Phone: 45-31224434, Fax: 45-31224127
Almstock Radio & Tv service, Sallingsvej 61, DK-2720 Vanløse, Phone: 45-38740021, Fax:45-38740031

SUOMI

Oy Perkko, PL 40 Rällsintie 6, SF-00721 Helsinki, Phone: +35-8947805000, Fax: +35-8947805480
Theho Video Oy, Niityläntie 3, SF-0620 Helsinki, SUOMI Phone: +35-891461500, Fax: +35-891461767

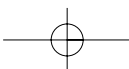
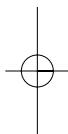
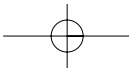

SHARP

SHARP ELECTRONICS (EUROPE) GMBH.

Sonninstrasse 3
20097 Hamburg
Germany

SHARP MANUFACTURING
ist ein Mitglied von:



MICROWAVE TECHNOLOGIES ASSOCIATION

<http://www.microwaveassociation.org.uk/>



Das Papier dieser
Bedienungsanleitung besteht
zu 100 % aus Altpapier

Gedruckt in Grossbritannien
TINS-A313URRO

SHARP

SHARP ELECTRONICS (EUROPE) GMBH.

Sonninstrasse 3
20097 Hamburg
Germany

SHARP MANUFACTURING
ist ein Mitglied von:



MICROWAVE TECHNOLOGIES ASSOCIATION

<http://www.microwaveassociation.org.uk/>



Gedruckt in Grossbritannien
TINS-A313URRO

Free Manuals Download Website

<http://myh66.com>

<http://usermanuals.us>

<http://www.somanuals.com>

<http://www.4manuals.cc>

<http://www.manual-lib.com>

<http://www.404manual.com>

<http://www.luxmanual.com>

<http://aubethermostatmanual.com>

Golf course search by state

<http://golfingnear.com>

Email search by domain

<http://emailbydomain.com>

Auto manuals search

<http://auto.somanuals.com>

TV manuals search

<http://tv.somanuals.com>