

SHARP®

LIQUID CRYSTAL DISPLAY CAMCORDER

MODEL
VL-Z7U

■ OPERATION MANUAL ■

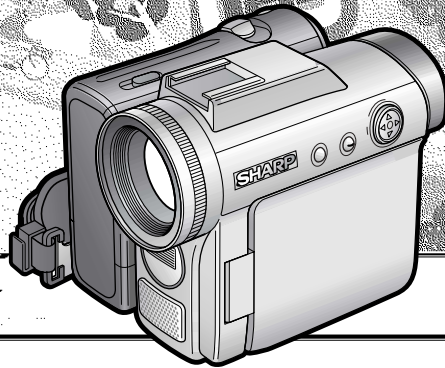

Viewcam Z

CG Silicon

Mini **DV**

The Mini DV logo is a trademark.

Please read this operation manual carefully before using the camcorder.

Important

For assistance in reporting the theft or loss of this product, record on the line below the model number and serial number which are located on the bottom of the unit. Please retain this information.

Model No.:

Serial No.:

• See page 94 for use of Demo mode

Thank you for purchasing this camcorder from SHARP. The camcorder will enhance your home video enjoyment and allow you to capture those special moments. Please read this operation manual to familiarize yourself with the camcorder's features, so that you will get the most out of it. The video techniques section will help you fully enjoy the many features this camcorder offers, and expand your video world.

Important Information for Consumers in the U.S.

WARNING: TO REDUCE THE RISK OF FIRE OR ELECTRIC SHOCK, DO NOT EXPOSE THIS APPLIANCE TO RAIN OR MOISTURE.



CAUTION:
TO REDUCE THE RISK OF ELECTRIC SHOCK, DO NOT REMOVE COVER. NO USER-SERVICEABLE PARTS INSIDE. REFER SERVICING TO QUALIFIED SERVICE PERSONNEL.

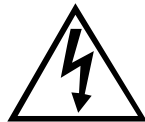

This symbol warns the user of uninsulated voltage within the unit that can cause dangerous electric shocks.



This symbol alerts the user that there are important operating and maintenance instructions in the literature accompanying this unit.

CAUTION

TO PREVENT ELECTRIC SHOCK, MATCH WIDE BLADE OF PLUG TO WIDE SLOT, FULLY INSERT.

(applies to the supplied AC adapter)

CAUTION

If the AC adapter is misplaced or needs to be replaced, obtain the same type of adapter from a SHARP service center or your local dealer.

PRODUCT DISPOSAL

This Product utilizes tin-lead solder, and a fluorescent lamp containing a small amount of mercury. Disposal of these materials may be regulated due to environmental considerations. For disposal or recycling information, please contact your local authorities or the Electronics Industries Alliance: www.eiae.org.

BATTERY DISPOSAL

CONTAINS LITHIUM-ION RECHARGEABLE BATTERY. MUST BE RECYCLED OR DISPOSED OF PROPERLY. CONTACT LOCAL AGENCIES FOR INFORMATION ON RECYCLING AND DISPOSAL PLANS IN YOUR AREA.

**CAUTION ON LITHIUM BATTERY
(for Camcorder and Remote Control unit)**

If a battery is reversed (positive end where the negative end belongs and vice versa), it can overheat and rupture. This has happened when young children install batteries backwards. Warn children *not* to take out batteries or install them. *Parents should install the lithium battery in the camcorder.*

COPYRIGHT WARNING: It is the intent of SHARP that this unit be used in full compliance with the copyright laws of the United States and that prior permission be obtained from copyright owners whenever necessary.

WARNING FCC Regulations state that any unauthorized changes or modifications to this equipment not expressly approved by the manufacturer could void the user's authority to operate this equipment.

INFORMATION

This equipment has been tested and found to comply with the limits for a Class B digital device, pursuant to Part 15 of the FCC Rules. These limits are designed to provide reasonable protection against harmful interference in a residential installation. This equipment generates, uses, and can radiate radio frequency energy and, if not installed and used in accordance with the instructions, may cause harmful interference to radio communications. However, there is no guarantee that interference will not occur in a particular installation. If this equipment does cause harmful interference to radio or television reception, which can be determined by turning the equipment off and on, the user is encouraged to try to correct the interference by one or more of the following measures:

- Reorient or relocate the receiving antenna.
- Increase the separation between the equipment and receiver.
- Connect the equipment into an outlet on a circuit different from that to which the receiver is connected.
- Consult the dealer or an experienced radio/TV technician for help.

DECLARATION OF CONFORMITY

Sharp Camcorder, Model VL-Z7U

This device complies with Part 15 of the FCC Rules. Operation is subject to the following two conditions: (1) This device may not cause harmful interference, and (2) this device must accept any interference received, including interference that may cause undesired operation.

RESPONSIBLE PARTY:

SHARP ELECTRONICS CORPORATION
Sharp Plaza, Mahwah, New Jersey 07430
Phone: 1-800-BE-SHARP

NOTE

The LCD panel of this camcorder is a very high technology product with more than 215,000 thin-film transistors*, giving you fine picture detail. Occasionally, a pixel may appear on the screen as a fixed point of blue, green, red, or black. Please note that this does not affect your camcorder's performance.

*Specifications are subject to change without notice.

Trademarks

- Microsoft and Windows are either registered trademarks or trademarks of Microsoft Corporation in the United States and/or other countries.
- DPOF is a trademark of CANON INC., Eastman Kodak Company, Fuji Photo Film Co., Ltd. and Matsushita Electric Industrial Co., Ltd.
- All other brand or product names are registered trademarks or trademarks of their respective holders.

IMPORTANT SAFEGUARDS

1. Read InstructionsCAll the safety and operating instructions should be read before the product is operated.
2. Retain InstructionsCThe safety and operating instructions should be retained for future reference.
3. Heed WarningsCAll warnings on the product and in the operating instructions should be adhered to.
4. Follow InstructionsCAll operating and use instructions should be followed.
5. CleaningCUnplug this product from the wall outlet before cleaning. Do not use liquid cleaners or aerosol cleaners. Use a damp cloth for cleaning.
6. AttachmentsCDo not use attachments not recommended by the product manufacturer as they may cause hazards.
7. Water and MoistureCDo not use this product near waterCfor example, near a bath tub, wash bowl, kitchen sink, or laundry tub; in a wet basement; or near a swimming pool; and the like.
8. AccessoriesCDo not place this product on an unstable cart, stand, tripod, bracket, or table. The product may fall, causing

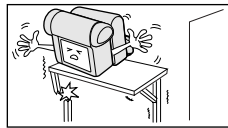

serious injury to a child or adult, and serious damage to the product. Use only with a cart, stand, tripod, bracket, or table recommended by the manufacturer, or sold with the product. Any mounting of the product should follow the manufacturer's instructions, and should use a mounting accessory recommended by the manufacturer.

9. A product and cart combination should be moved with care. Quick stops, excessive force, and uneven



- surfaces may cause the product and cart combination to overturn.
10. VentilationCSlots and openings in the cabinet are provided for ventilation and to ensure reliable operation of the product and to protect it from overheating, and these openings must not be blocked or covered. The openings

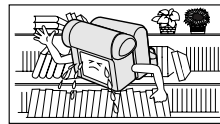

should never be blocked by placing the product on a bed,

sofa, rug, or other similar surface. This product should not be placed in a built-in installation such as a bookcase or rack unless proper ventilation is provided or the manufacturer's instructions have been adhered to.

11. Power SourcesCThis product should be operated only from the type of power source indicated on the marking label. If you are not sure of the type of power supply to your home, consult your product dealer or local power company. For products intended to operate from battery power, or other sources, refer to the operating instructions.

-
12. **Grounding or Polarization**—This product may be equipped with a polarized alternating-current line plug (a plug having one blade wider than the other). This plug will fit into the power outlet only one way. This is a safety feature. If you are unable to insert the plug fully into the outlet, try reversing the plug. If the plug should still fail to fit, contact your electrician to replace your obsolete outlet. Do not defeat the safety purpose of the polarized plug.
13. **Power-Cord Protection**—Power-supply cords should be routed so that they are not likely to be walked on or pinched by items placed upon or against them, paying particular attention to cords at plugs, convenience receptacles, and the point where they exit from the product.
14. **Lightning**—For added protection for this product during a lightning storm, or when it is left unattended and unused for long periods of time, unplug it from the wall outlet and disconnect the antenna or cable system. This will prevent damage to the product due to lightning and power-line surges.
15. **Power Lines**—An outside antenna system should not be located in the vicinity of overhead power lines or other electric light or power circuits, or where it can fall into such power lines or circuits. When installing an outside antenna system, extreme care should be taken to keep from touching such power lines or circuits as contact with them might be fatal.
16. **Overloading**—Do not overload wall outlets, extension cords, or integral convenience receptacles as this can result in a risk of fire or electric shock.
17. **Object and Liquid Entry**—Never push objects of any kind into this product through openings as they may touch dangerous voltage points or short-out parts that could result in a fire or electric shock. Never spill liquid of any kind on the product.
18. **Servicing**—Do not attempt to service this product yourself as opening or removing covers may expose you to dangerous voltage or other hazards. Refer all servicing to qualified service personnel.

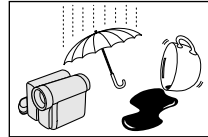

-
19. **Damage Requiring Service**—Unplug this product from the wall outlet and refer servicing to qualified service personnel under the following conditions:
 - a. When the power-supply cord or plug is damaged,
 - b. If liquid has been spilled, or objects have fallen into the product,
 - c. If the product has been exposed to rain or water,
 - d. If the product does not operate normally by following the operating instructions. Adjust only those controls that are covered by the operating instructions as an improper adjustment of other controls may result in damage and will often require extensive work by a qualified technician to restore the product to its normal operation,
 - e. If the product has been dropped or damaged in any way, and
 - f. When the product exhibits a distinct change in performance—this indicates a need for service.
 20. **Replacement Parts**—When replacement parts are required, be sure the service technician has used replacement parts specified by the manufacturer or have the same characteristics as the original part. Unauthorized substitutions may result in fire, electric shock, or other hazards.
 21. **Safety Check**—Upon completion of any service or repairs to this product, ask the service technician to perform safety checks to determine that the product is in proper operating condition.
 22. **Wall or Ceiling Mounting**—The product should be mounted to a wall or ceiling only as recommended by the manufacturer.
 23. **Heat**—The product should be situated away from heat sources such as radiators, heat registers, stoves, or other products (including amplifiers) that produce heat.

Contents

Supplied Accessories	xi
Optional Accessories	xi
Precautions	xii
Operation References	
Part Names	1
Warning Indicators	4
Preparation	
Attaching and Removing the Battery Pack	6
Charging the Battery Pack	8
Powering the Camcorder from an AC Outlet	9
Inserting and Removing a Cassette	10
Inserting and Removing a Card	11
Installing the Lithium Batteries	12
Setting the Date and Time	14
Using the Lens Cap	15
Adjusting the Hand Strap	16
Using the Grip	16
Detaching the Lens Hood	17
Using the Viewfinder	17
Using the LCD Monitor	19
Tips on Recording Positions	20
Basic Operations	
Camera Recording	
Selecting the Camcorder Mode	21
Easy Camera Recording on Tape in Full Auto Mode ..	22
Zooming	23
Power Standby Mode	24
Turning on/off the Backlight	24
Auto Focus	25
Macro Shots	25
Remaining Recording Time Display	26
Remaining Battery Power Display	26
Playback	
Tape Playback	27
Volume Control	28
Still	28
Video Search	28
Using Earphones (Commercially Available)	29
Adjusting the Phones Volume	29
Watching Playback on a TV	30

Useful Features	Control Buttons	31
	Using the Mode Screens	31
	Using the Menu Screens	32
	Camera Recording	
	Setting the Digital Zoom	33
	Backlight Compensation (BLC)	34
	Gain-up	35
	Fade In and Fade Out	36
	Quick Return	37
	Edit Search	38
	Still Recording on Tape	38
	Digital Image Stabilization (DIS)	39
	Self Recording	40
	Wide Screen (16:9)	42
	Recording in LP (Long Play Recording) Mode	43
	Using the Zoom Microphone (Optional Accessory)	44
	Windbreak	45
	Selecting the 16-bit Audio Recording Mode	46
	Playback	
	Using the Remote Control	47
	Tape Playback Functions with the Remote Control	48
	Selecting the Date and Time of Recording Display	49
	Picture Effect Playback	50
	Rotate Playback	51
	Copying an Image from Tape to Card	52

Advance Features	Camera Recording	
	Manual Focus	53
	Returning to Auto Focus	54
	Displaying the Manual Setting Screen	54
	White Balance Lock	55
	Manual Iris	56
	Manual Gain	57
	Setting the Camcorder to Full Auto Mode	58
	Scene Menu (Program AE)	59







Contents

Advanced Features	Playback	
	Using the Time Code	60
	Editing	61
	Recording from an External Source	62
	Editing with the DV Terminal (IEEE1394)	64
	Using the Camcorder as a Converter	66
	Audio Dubbing Feature	68
	Selecting the Audio Playback Mode	70
Digital Still Camera Features	Camera Recording	
	Selecting the Picture Quality and Image Size	71
	Card Recording	73
	Selecting the Flash Mode	74
	Red-eye Reduction	75
	Recording with the Self-timer	76
	Formatting a Card	77
	Setting the File Numbering Method	78
	Playback	
	Card Playback	79
	Playback Zoom	80
	Delete Protection	81
	Deleting Stored Images	82
	Print Order	84
Transferring Data on Card to Computer	86	
Installing the USB Driver	86	
Slide Show Playback	89	
Appendix	Picture/Backlight Adjustments	90
	Turning off the Confirmation Sound	91
	Selecting the Language for the Information Display	92
	Setting the Camcorder to Factory Presettings	93
	Demonstration Mode	94
	Useful Information	95
	Troubleshooting	101
	Specifications	105
	On-screen Display Index	106
		• Guía de operación rápida en español

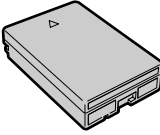
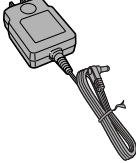
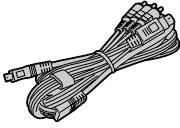
Note:

- Before requesting service, please read "Troubleshooting" carefully. (See pages 101–104.)

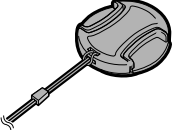
Supplied Accessories

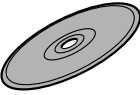
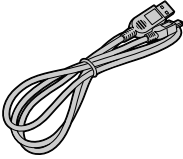
 <p>Battery pack BT-L226U*</p>	 <p>AC adapter UADP-0339TAZZ*</p>	 <p>Audio/video/S-video cable OCNW-B173WJZZ</p>	 <p>Remote control RRMCGA149WJSA</p>
 <p>CR2025 type lithium battery for remote control</p>	 <p>CR1216 type lithium battery for camcorder</p>	 <p>Lens cap GCOVHA002WJZZ</p>	 <p>8 MB SD Memory Card</p>
 <p>CD-ROM CDSKAA028WJ01</p>	 <p>USB cable OCNW-A703WJZZ</p>		

* The part numbers for the AC adapter and battery pack supplied with this camcorder are valid only in the U.S. and Latin America. If this camcorder was purchased outside of these areas, the part numbers may be different. Please refer to the part numbers printed on the labels of the supplied AC adapter and battery pack.

Optional Accessories

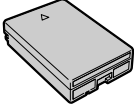
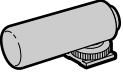
 <p>Standard-life battery pack BT-L226U</p>	 <p>Zoom microphone VR-8MCN</p>
--	--

Note:

- The listed model names are for U.S. accessories.

For optional and additional accessories, contact your local dealer, call the Sharp Accessories and Supply Center at 1-800-642-2122, or visit SHARP's website (<http://www.sharpusa.com>).

Precautions

- **Before recording an important scene, please perform the recording test, then playback to check if the scene was recorded properly. If noise occurs, use a commercially available cleaning tape to clean the video heads (see page xiv).**
- **Always respect prohibitions or restrictions on the use of electronic equipment on commercial flights or in other sensitive areas.**
- **Be aware of the temperature and humidity.**

You can use your camcorder at 32°F to 104°F (0°C to L 40°C), and at 30% to 80% relative humidity. Do not store the unit in an unventilated car in the summer, in direct sunlight, or near strong heat sources; this can result in severe damage to the unit casing and circuitry.

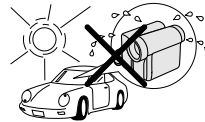

- **Do not aim the lens at the sun.**
Do not allow direct sunlight to strike the camcorder lens or LCD monitor screen, whether or not recording is in progress, as it may damage the CCD sensor or LCD screen surface. Be particularly careful when recording outside.

- **Avoid magnetic sources.**
Using the camcorder near strong fluorescent lights, motors, televisions, or other magnetic sources may adversely affect recorded images.

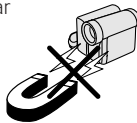

- **Using the camcorder near a broadcasting station or other powerful transmission source may cause buzzing or picture deterioration.**

- **Avoid situations where water, sand, dust or other foreign matter could get on or inside the camcorder, and do not use or leave your camcorder in areas with excessive smoke, steam or moisture.**
Such environments can cause malfunctions or cause mildew to form on the lenses. Be sure to keep the unit in a well-ventilated location.

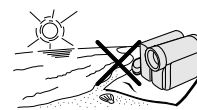

- **Avoid shocks and dropping.**
Do not drop or otherwise subject the camcorder to hard shocks or strong vibrations. Bumping or striking the unit during recording will generate noise in the recorded image.

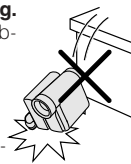

- **Avoid placing the camcorder in close proximity to lighting equipment.**
The heat from incandescent lights may deform the camcorder, or cause it to malfunction.

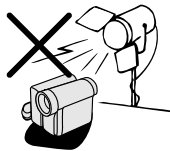

- **Some small, portable tripods may be difficult to attach and may not be sturdy enough to support your camcorder. Be sure to use only a strong, stable tripod.**

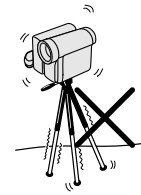

- **When using your camcorder in a cold environment, the LCD monitor screen often appears less bright immediately after the power is turned on. This is not a malfunction. To prevent the camcorder from becoming too cold, wrap it in a thick cloth (a blanket, etc.).**



Operation References

Part Names

For details on the use of each part, refer to the page number indicated in parentheses.

Front view

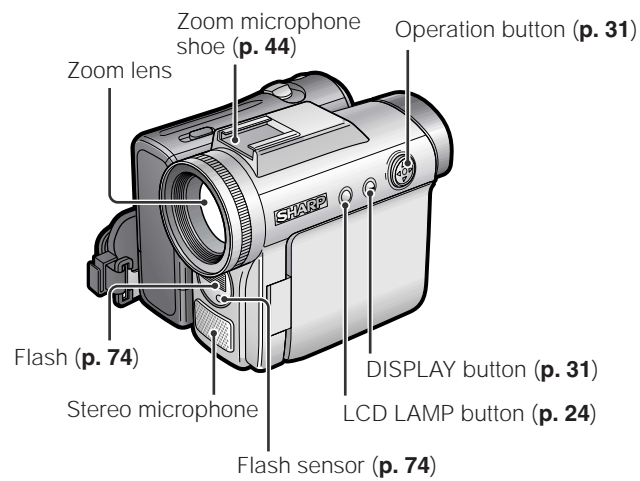

Operation References

Left view

Operation References

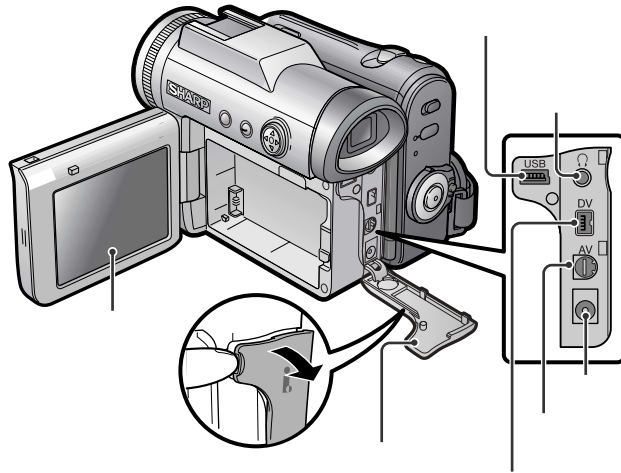

Lithium battery cover (p. 12)

Tripod socket*

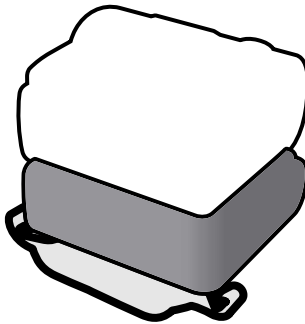

Card slot cover (p. 11)



Operation References

Warning Indicators

If a warning indicator appears on the screen, follow the specified instructions.

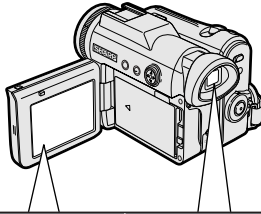

Displayed for the first 3 seconds	Displayed after 3 seconds	Description of warning
INSERT A CASSETTE.		There is no video cassette in the camcorder. Insert a cassette (see page 10).
EJECT THE CASSETTE.	EJECT THE CASSETTE.	The video cassette is defective and should be removed (see page 10).
CASSETTE NOT RECORDABLE.		The erasure protect tab on the video cassette has been slid to the record-protect position, preventing recording (see page 96).
THE TAPE ENDS SOON.		The tape is about to end. Prepare a new cassette.
CHANGE THE CASSETTE.	TAPE END	The tape has reached the end. Replace it with a new cassette (see page 10).
BATTERY IS TOO LOW.		The battery is almost depleted. Replace it with a fully charged battery pack (see pages 6 and 7).
DEW		Dew has formed inside the camcorder. Wait a few hours for the dew to dry away (see page xiii). About 10 seconds after this warning appears, the camcorder automatically turns off.
		The video heads are clogged and should be cleaned (see page xiv).
LAMP	LAMP	The fluorescent lamp behind the LCD monitor is close to the end of its service life. Call your local authorized Sharp dealer to have it replaced.
USB	USB	The battery is almost depleted when the camcorder transfers data through the USB cable. Use the AC adapter or fully charged battery pack as the power source (see pages 6–9, 88).

Displayed for 5 seconds	Description of warning
NO MEMORY CARD	The card is not inserted or is inserted improperly. Check that it is properly inserted (see page 11).
MEMORY CARD FULL	The capacity of the card is full and cannot store any more images. Delete unnecessary images (see page 82) or replace the card with a new one (see page 11).
NO DATA ON MEMORY CARD	The card has no images recorded in the format the camcorder can recognize.
MEMORY CARD ERROR	The images in the card are corrupted or recorded in a format which is not compatible with this camcorder. Format the card to use it with this camcorder (see page 77)*.
FORMAT MEMORY CARD	The card has not been formatted with this camcorder. Format the card (see page 77)*.
MEMORY CARD PROTECTED	The card is write-protected (see page 11).
DATA PROTECTED	You are trying to delete a protected image. Cancel the protection setting (see page 81).
MEMORY CARD READ ERROR	The selected image cannot be read by this camcorder. Format the card to use it with this camcorder (see page 77)*.
CANNOT STORE DATA	The card cannot record any data due to a problem with the card or data on the card. Replace the card (see page 11).
PLEASE USE PHOTO BUTTON	The camcorder cannot record with the Start/Stop button in Card Recording mode. Press the PHOTO button (see page 73).
MAXIMUM 999 IMAGES	The print order cannot be set to more than 999 images.
MAXIMUM FILE NUMBER	You cannot record any image with a file number bigger than 999–9999. Set FILE NO. menu item to "RESET" (see page 78), then format the card (see page 77)* or replace the card with a new one (see page 11).

* Formatting a card erases all stored images, including delete-protected images. Be sure to backup important data on your computer or other media before formatting the card.

Note:

- N indicates a flashing display.

Preparation

Attaching and Removing the Battery Pack

Attaching

Preparation

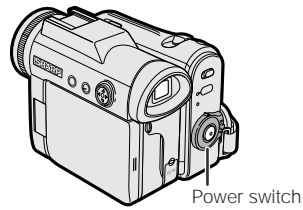

- 1 Make sure that the Power switch is set to OFF.

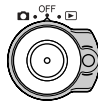

- 2 Open the LCD monitor to a 90° angle to the camcorder body.

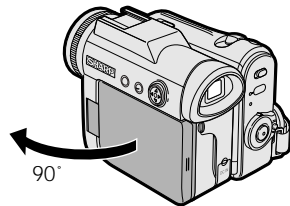

- 3 Slide the battery pack in the direction of the arrow with the "△" mark facing out.

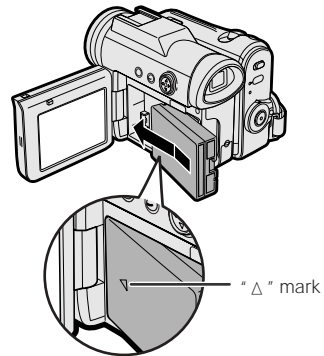

- 4 Push the battery pack in the direction of the arrow until it clicks.

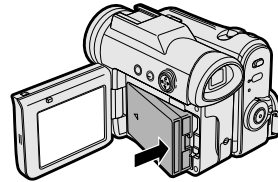

Removing

- 1 Make sure that the Power switch is set to OFF, then open the LCD monitor to a 90° angle to the camcorder body.

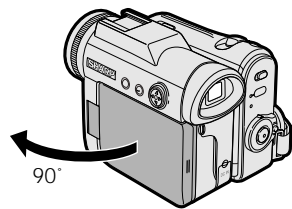

- 2 Slide the battery release in the direction of the arrow.

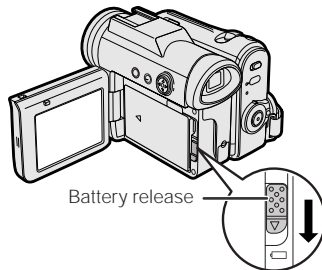

- 3 Take the battery pack out.

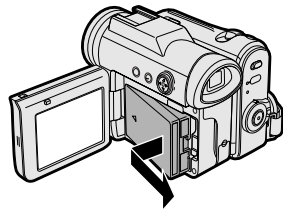

Notes:

- **BEFORE REMOVING THE BATTERY PACK, ALWAYS STOP RECORDING OR PLAYBACK AND TURN THE POWER OFF.** Removing the battery pack while shooting or during playback may damage the tape by causing it to wrap around the video head drum or destroy the card, rendering it unreadable and unwritable.
- Remove the battery pack from the camcorder if you will not use the camcorder for a long period of time.
- Make sure that the battery pack is firmly attached during operation. If it is not, the battery pack may come off or camcorder operation may fail because of the poor contact pressure.
- To prevent damage to the battery pack when removing, be sure to firmly hold the battery pack while pressing the release.
- Use only SHARP model BT-L226 battery packs with this camcorder. Use of other batteries may create a risk of fire or explosion.
- Before closing the LCD monitor, make sure the battery pack is properly attached to the camcorder, otherwise the monitor may be damaged.

Preparation

Charging the Battery Pack

- 1 Attach the battery pack on the camcorder, and make sure that the Power switch is set to OFF.
- 2 Open the DC IN jack cover.

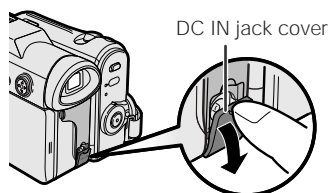

- 3 Insert the DC plug into the DC IN jack of the camcorder (1), and plug the AC plug into a power outlet (2).
 - The POWER/CHARGE (RED) indicator lights up red.

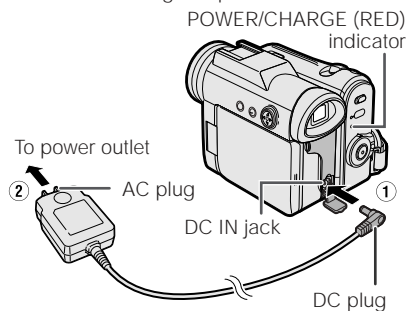

- The POWER/CHARGE (RED) indicator turns off when the battery is charged.

- 4 Remove the DC plug from the DC IN jack, then remove the AC adapter from the power outlet.

Charging time and maximum continuous recording and playback times in Tape modes

Battery pack	Charging time	Max. continuous recording time		Max. continuous playback time on LCD
		LCD closed	LCD open	
BT-L226	120	115	100	100

- The chart specifies the approximate times in minutes.

Notes:

- Charge the battery pack between 50°F and 86°F (10°C and 30°C). The battery pack may not charge properly at temperatures too low or too high.
- The battery pack and AC adapter become warm during charging. This is not a malfunction.
- Using the zoom (see page 23) and other functions or turning the power on and off frequently will increase power consumption. This may result in a decrease in the actual recording time compared to the maximum continuous recording time listed above.
- The charging time and recording time may vary depending on the ambient temperature and the condition of the battery pack.
- See pages 98 and 99 for more information on using the battery pack.
- Charge only SHARP model BT-L226 battery packs. Other types of battery packs may burst, causing personal injury and damage.
- When attaching the supplied audio/video/S-video cable or USB cable, remove the DC plug, open the terminal cover and connect it.

Powering the Camcorder from an AC Outlet

You can also power the camcorder from a power outlet by using the supplied AC adapter.

Note:

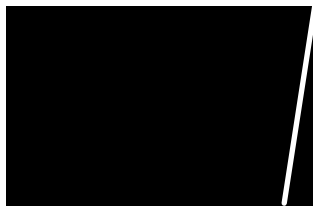

- The supplied AC adapter is specially designed for use with this camcorder, and should not be used as a power supply for other camcorders.

- 1** Make sure that the Power switch is set to OFF.
- 2** Open the DC IN jack cover.



- 3** Insert the DC plug into the DC IN jack of the camcorder (1), and plug the AC plug into a power outlet (2).

DC IN jack

- 4** Hold down the Lock button and set the Power switch to  or .
- The POWER/CHARGE (RED) indicator lights up green.

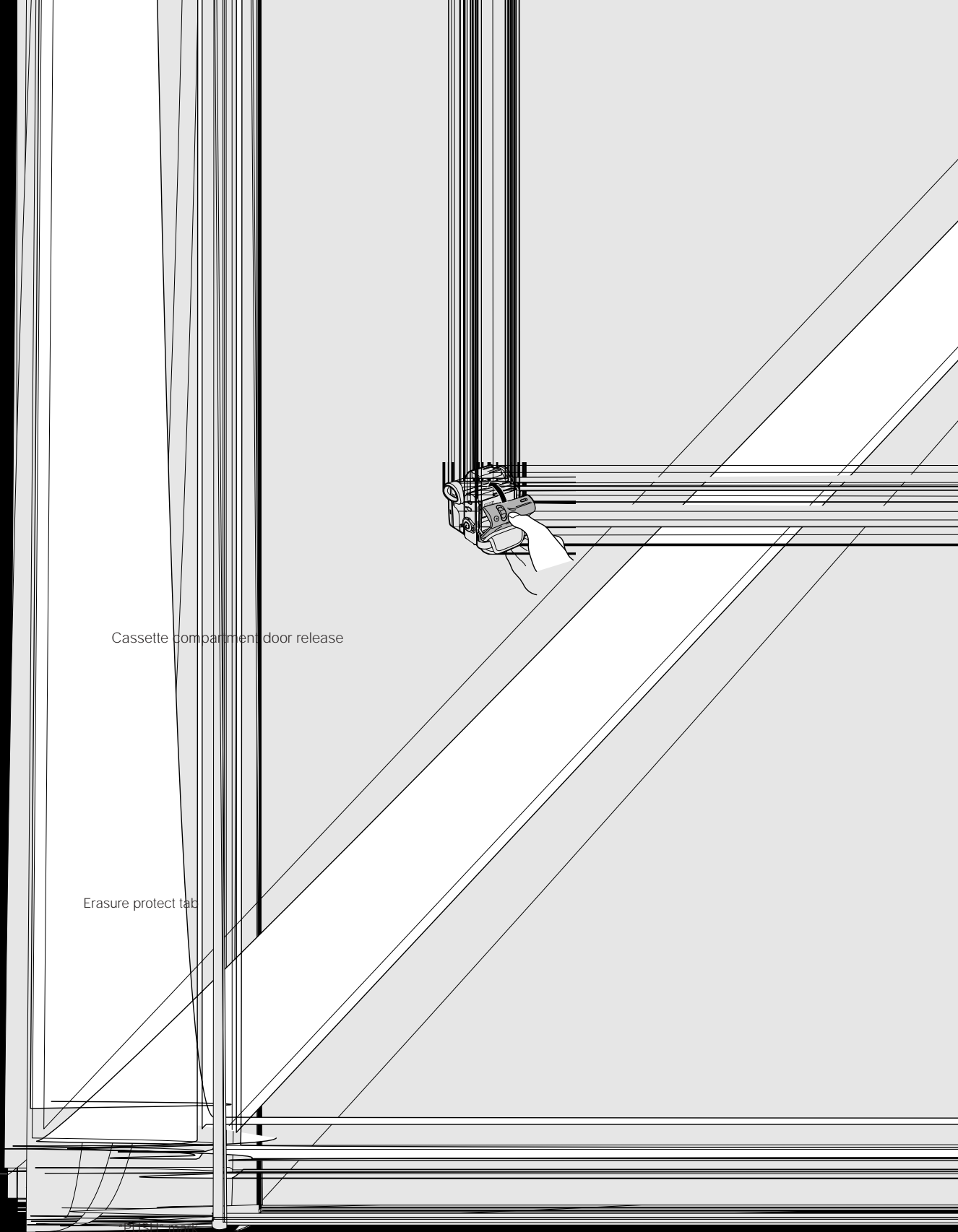

Cassette compartment door release

Erasure protect tab

Inserting and Removing a Card

You can use an SD Memory Card (supplied) or a MultiMediaCard (commercially available) for storing still images.

Inserting

- 1 Make sure that the Power switch is set to OFF.
- 2 Open the card slot cover.

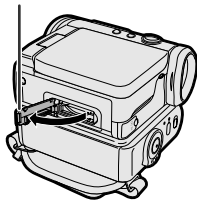

- 3 Insert a card into the slot as shown below, and push it in fully.

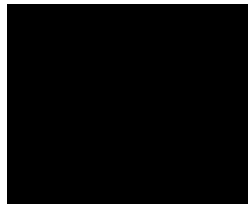

- 4 Close the card slot cover securely.

Removing

Perform steps 1 and 2 above, push the card and release slowly (1). Then pull the card straight out (2) as shown below.

Notes:

- You can use only the SD Memory Card or the MultiMediaCard (see page 97).
- The supplied card is preformatted for immediate use.
- See page 97 for more information on the cards intended for use with this camcorder.
- **Do not remove the card from the camcorder while recording data on the card (S indicator flashes during recording). This may delete the recorded image or damage the card.**
- **You cannot insert or remove the card when using a tripod.**

About the write-protect switch

SD Memory Card has a write-protect switch. When the switch is set to the locked position, you cannot record/delete data or format the card. Set it to the unlocked position to record/delete data or format the card.

Back view

Unlocked position

Locked position

Preparation

Installing the Lithium Batteries

Installing the Memory Battery

The supplied CR 1216 type lithium battery is used to store the memory of the date and time settings.

Preparation

- 1 Make sure that the Power switch is set to OFF.
- 2 Open the LCD monitor to a 90° angle to the camcorder body.
- 3 Slide the battery release in the direction of the arrow, then take the battery pack out.

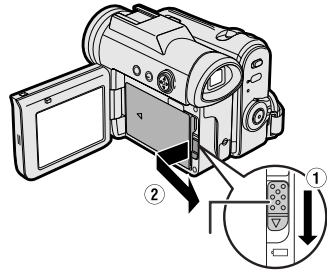

- 4 Pull out the lithium battery cover in the direction of the arrow.

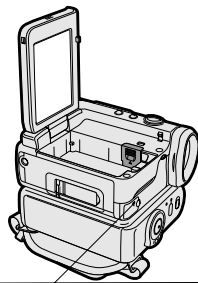

Installing the Battery to Remote Control

The supplied CR 2025 type lithium battery is used to power the remote control unit.

- 1 Hold the remote control facing down, and pull out the battery holder while pressing the tab toward the center.

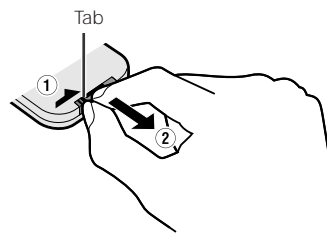

- 2 Insert the larger lithium battery into the battery holder with the H side of the battery facing the m side of the holder.

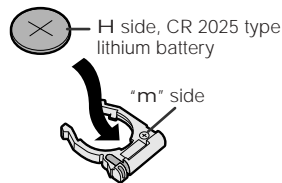

- 3 Insert the battery holder back into position.

Notes on the Use of the Lithium battery

CAUTION The battery used in this device may present a risk of fire or chemical burn if mistreated. Do not recharge, disassemble, heat above 212°F (100°C), or incinerate. Replace battery with the type CR1216 for the camcorder and the type CR2025 for the remote control unit of Toshiba Battery Co., Ltd. only. Use of another battery may present a risk of fire or explosion. Dispose of used battery promptly. Keep away from children. Do not disassemble and do not dispose of in fire.

- Do not short-circuit, recharge, disassemble, or heat the lithium battery.
- Should the lithium battery leak, wipe the battery compartment clean, and then insert a new battery.
- The lithium batteries will last about one year under normal usage.

Preparation

Setting the Date and Time

Available modes:

Tape Camera, Card Camera

Example: Setting the date to June 2, 2004 (JUN. 2. 2004) and the time to 10:30 am (10:30 AM).

Preparation

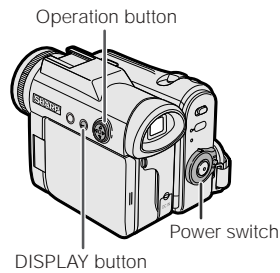

Note:

- Before performing the steps below, make sure that the CR1216 type lithium battery has been installed (see page 12).
- The example screens shown are for Tape Camera mode.

- 1 Hold down the Lock button and set the Power switch to .

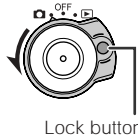

- 2 Press the DISPLAY button until the mode screen appears.



- 3 Press ∇ or Δ on the Operation button to select "MENU", then press the center of the Operation button.



- 4 Press Δ or ∇ to select "EXECUTE", then press the center of the Operation button.

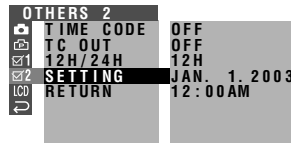

- 5 Press the center of the Operation button.



- 6 Press Δ or ∇ to select "JUN" (month), then press the center of the Operation button.



- 7 Press Δ or ∇ to select "2" (day), then press the center of the Operation button.



- 8 Press Δ or ∇ to select "2004" (year), then press the center of the Operation button.



- 9 Press Δ or ∇ to select "10 AM" (hour), then press the center of the Operation button.



- 10 Press Δ or ∇ to select "30" (minute), then press the center of the Operation button.

SETTING JUN. 2. 2004
10:30:00AM

- The internal clock now starts operating with the seconds display.

- 11 Press the DISPLAY button to turn off the menu screen.

Note:

- If the date and time have been set, the SETTING 1 screen (T) appears in step 4. Select "SETTING" in the OTHERS 2 screen (2) using the Operation button.

Using the Lens Cap

Attach the strap of the lens cap to the hand strap as shown below.

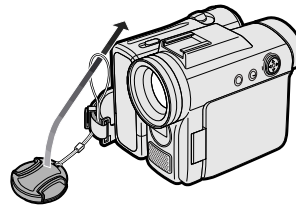

Preparation

When attaching or removing the lens cap, grasp the indents on both sides of the cap.

Changing to the 24-hour Time Mode

- 1 After performing step 10 above, press ∇ or Δ to select "12H/24H", then press the center of the Operation button.

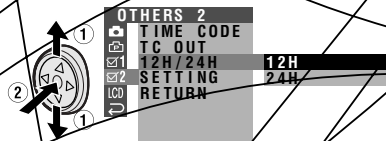

- 2 Press ∇ or Δ to select "24H" then press the center of the Operation button.

12H/24H 24H

- 3 Press the DISPLAY button to turn off the menu screen.

Notes:

- The date and time, once set, are internally recorded even when not displayed on the screen.
- The menu screen automatically turns off if no settings are made within 5 minutes.

When reusing, remove the lens cap and attach the lens cap cord to the fastener so that the cap will not get in the way.

Note:

- Always attach the lens cap over the lens when not using the camcorder.

Preparation

Adjusting the Hand Strap

- 1 Open the hand strap flap (1) and grip strap (2).

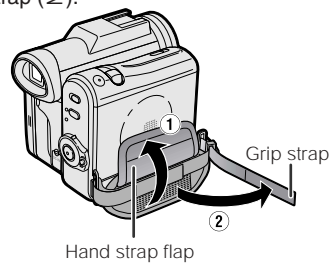

- 2 Loosen the grip strap, pass your right hand through the hand strap, and put your thumb close to the Start/Stop button and your middle finger on the Power Zoom control. Then, pull the grip strap tight until it fits snugly.

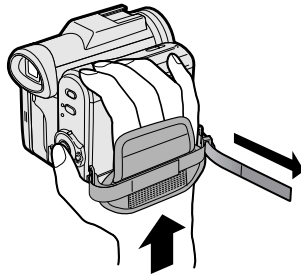

- 3 Seal the Velcro® fasteners of the grip strap and the hand strap flap.

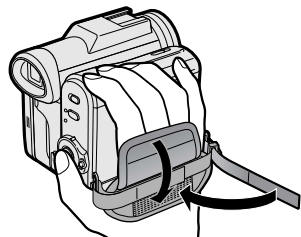

Using the Grip

Rotate the grip 135° forward or 90° downward so that you can record images easily from high or low angle (see page 20).

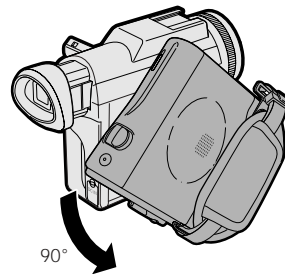
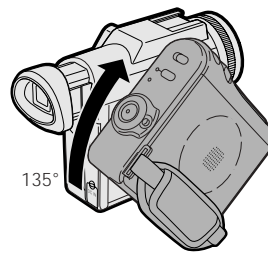

Note:

- The grip cannot rotate when a tripod is attached.

Detaching the Lens Hood

Before using a commercially available conversion lens, detach the lens hood as shown below.

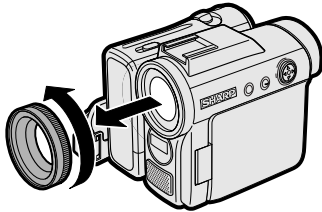

Note:

- You cannot attach the supplied lens hood or lens cap to a conversion lens.

Using the Viewfinder

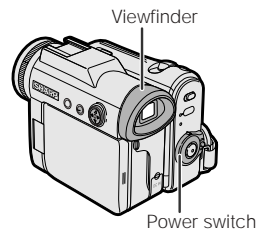

You can record the subject using the electronic viewfinder. You can also watch playback through the viewfinder.

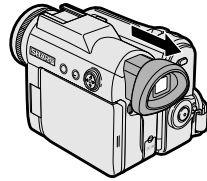

Preparation

- 1 Pull out the viewfinder completely.



- 2 Hold down the Lock button and set the Power switch to  or .

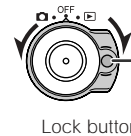

(Continued on the next page) 17

Preparation

Closing the viewfinder

Push in the viewfinder completely.

Adjusting the diopter

Adjust the diopter according to your eyesight when the picture in the viewfinder or the characters on the on-screen display is not clear.

- 1 Pull out the viewfinder completely.
- 2 Hold down the Lock button and set the Power switch to .
- 3 While looking through the viewfinder, turn the diopter adjustment dial until the indicators in the viewfinder are clearly visible.

Diopter adjustment dial

See page 99.

Preparation

Note

- Do not touch the lens.
- Do not touch the viewfinder.
- Do not touch the diopter adjustment dial.
- Do not touch the Power switch.

Using the LCD Monitor

You can use the LCD monitor to play back recordings that you have made or to watch the subject during recording.

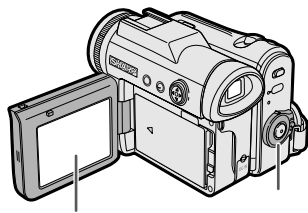

- 1 Open the LCD monitor to a 90° angle to the camcorder body.

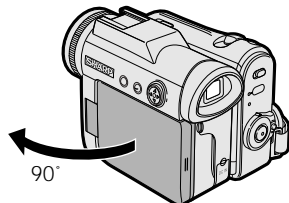

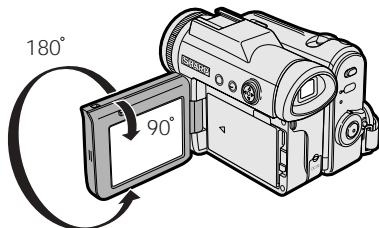

- 2 Adjust the LCD monitor to an angle that allow easy viewing of the on-screen picture.
 - The LCD monitor rotates 270° vertically.



Note: Do not try to rotate the LCD monitor vertically until the monitor is completely opened.

- You can also fold the LCD monitor into the camcorder with the screen facing out for watching playback on the monitor.

- 3 Hold down the Lock button and set the Power switch to  or .

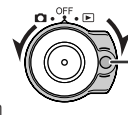

Note:

- Battery consumption is larger when the LCD monitor is opened. Use the viewfinder instead of the LCD monitor when you want to save the battery power.

Closing the LCD monitor

Return the LCD monitor to the vertical 90° position with the screen facing in, and fold it into the camcorder into place.

Notes:

- Do not use excessive force when moving the LCD monitor.
- When closing the LCD monitor, do not tilt it; otherwise the monitor may not close properly and may become damaged.
- Do not pick up the camcorder by the LCD monitor.
- Do not place the camcorder with the LCD monitor screen facing down.
- Close the LCD monitor completely with the screen facing in when not in use.
- Before closing the LCD monitor, make sure the battery pack is properly attached to the camcorder, otherwise the monitor may be damaged.

Preparation

Tips on Recording Positions

Preparation

Turn the LCD

Balance your weight on both legs.

Turn the LCD monitor so that the screen faces upward.

Basic Operations

Camera Recording

Selecting the Camcorder Mode

This camcorder includes functions for use as both a video camera for recording and playing back images on tapes and as a digital still camera for recording and playing back still images on cards. One of the following camcorder modes needs to be set before starting any operation.

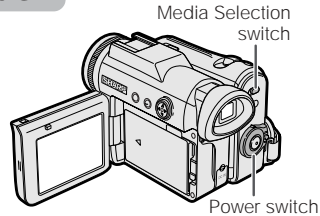

Camcorder modes

<p>Tape Camera mode</p> <p>For recording motion and still images on a tape.</p> <p>1 Set the Media Selection switch to .</p> <p>2 Hold down the Lock button and set the Power switch to .</p> <p>Lock button</p>	<p>Tape Playback mode</p> <p>For playing back or editing motion and still images recorded on a tape.</p> <p>1 Set the Media Selection switch to .</p> <p>2 Hold down the Lock button and set the Power switch to .</p> <p>Lock button</p>
<p>Card Camera mode</p> <p>For recording still images on a card.</p> <p>1 Set the Media Selection switch to .</p> <p>2 Hold down the Lock button and set the Power switch to .</p> <p>Lock button</p>	<p>Card Playback mode</p> <p>For playing back still images recorded on a card.</p> <p>1 Set the Media Selection switch to .</p> <p>2 Hold down the Lock button and set the Power switch to .</p> <p>Lock button</p>

Notes:

- To turn the power off, set the Power switch to OFF without pressing the Lock button.
- Do not change the camcorder mode by operating the Media Selection switch during recording or playback, as this may cause damage to the tape or card.

Basic Operations Camera Recording

Easy Camera Recording on Tape in Full Auto Mode

Available mode:
Tape Camera

- Before you start recording, perform the operations described on pages 6 through 20 to prepare your camcorder for recording.

4 Press the **S** button to start recording.



is not displayed at this time,
the camcorder to Full Auto mode
(see page 58).

To pause recording

Press the Start/Stop button again. Recording pauses, and the camcorder enters Recording Standby mode.

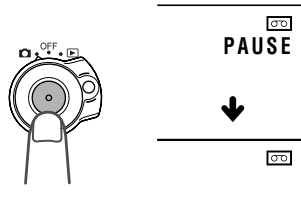

To turn the power off

Set the Power switch to OFF without pressing the Lock button.

Note:

- If the camcorder remains in Recording Standby mode for more than 5 minutes in Tape Camera mode, the power will automatically turn off to save battery power and to protect the tape from being damaged. To resume recording, set the Power switch to OFF and then back to . (The camcorder will make a confirmation sound when it is left in Recording Standby mode for about 4 minutes.)

Zooming

Available modes:

Tape Camera, Card Camera

Zooming allows you to move visually closer to or farther from a subject without physically changing your position. When using the optical zoom, you can enlarge the subject up to 10K.

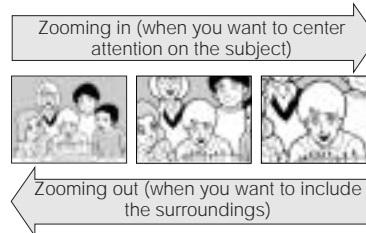

Zooming in

Push the Power Zoom control to the T (telephoto) side to get a close-up view (1).

Zooming out

Push the Power Zoom control to the W (wide angle) side to get a wide field of view (2).

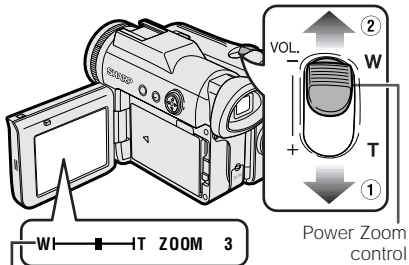

Zoom range indicator

- The zoom range indicator shows you the current zoom setting.
- The zoom speed depends on how far you push the Power Zoom control.

Notes:

- The camcorder is unable to focus when zooming in on subjects within 5 feet (1.5 m).
- See page 33 for how to use the digital zoom.

Basic Operations Camera Recording

Power Standby M

Available mode:

Tape Camera

Power Standby mode allows you to prevent accidental recording by locking the camera and disabling most operations except canceling the recording.

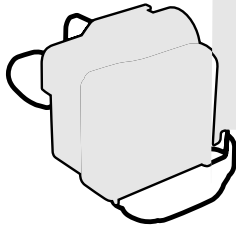

Basic Operations

Hold down the STANDBY button for more than 2 seconds when you pause recording in Tape Camera mode.

- The screen turns off and the STANDBY indicator lights up.

Auto Focus

Available modes:

Tape Camera, Card Camera

The camcorder is preset to Auto Focus mode, which is designed to focus on most types of subjects. In Auto Focus mode, the camcorder automatically focuses on the subject in the center of the scene. Always keep the subject in the center of the scene.

Notes:

- If no subject is in the center of the scene, the focus area will expand and the subject nearest the center will be focused on.
- Auto Focus may not work in the situations described on page 53. In these situations, use the manual focus function.
- The camcorder may not be able to focus correctly if the subject is closer than approximately 5 feet (1.5 m). Set the zoom control to wide angle, and try refocusing again.
- If the lens is dirty or fogged, the camcorder may not be able to focus correctly.

Macro Shots

Available modes:

Tape Camera, Card Camera

This camcorder lets you shoot close-up images of small objects such as flowers and insects, or make title frames for your videos. When you want to record a magnified image of a subject which is within approximately 5 feet (1.5 m) of the camcorder, do not zoom in on it. Instead, zoom out all the way by pushing the Power Zoom control to the W side, and then move the camcorder closer to the subject until you obtain the desired angle of view. The camcorder will automatically focus on the subject when the lens is set for the widest angle.

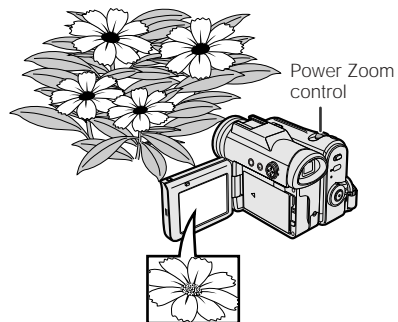

Note:

- When you are recording a macro shot, be sure that the subject receives sufficient illumination.

Basic Operations Camera Recording



Basic Operations

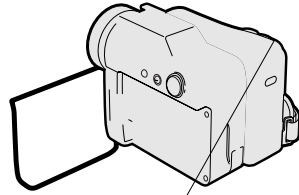

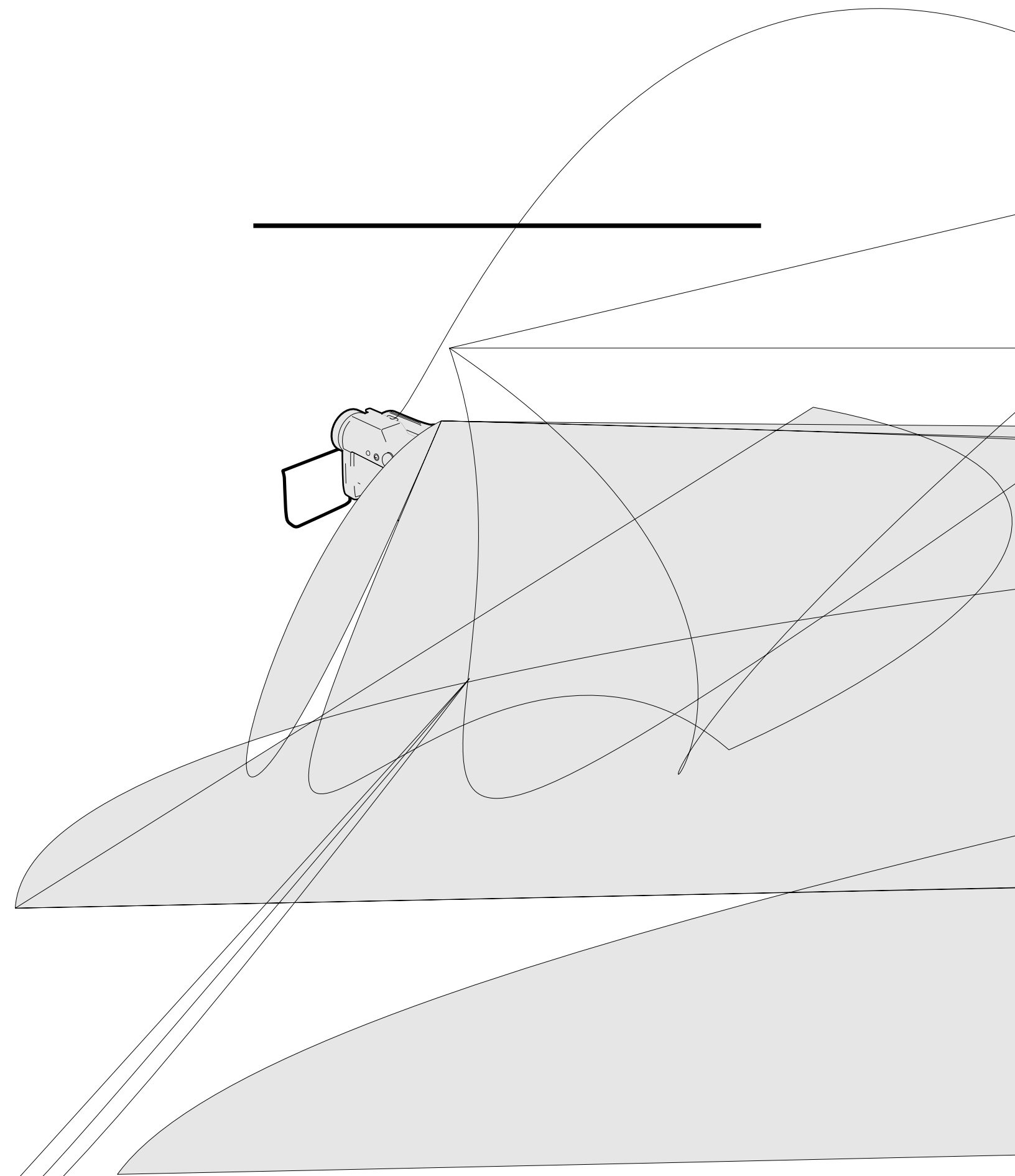

Basic Operations Playback

Volume Control

Available mode:
Tape Playback

When the camcorder is in Tape Playback mode, push the Volume control to the L or + side to increase (1) or decrease (2) the volume.

The volume level indicator will appear on the LCD screen during adjustment only. Once the Volume control is released, the volume level indicator will disappear shortly afterwards.

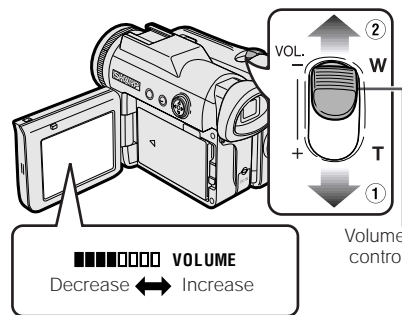

Still

Available mode:
Tape Playback

The still function allows you to pause in Tape Playback mode.

During Tape Playback, press Δ on the Operation button.

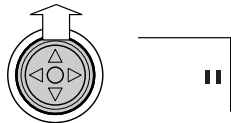

To return to normal playback, press Δ again.

Notes:

- The sound is off in Still mode.
- To protect the tape, the camcorder automatically returns to normal playback if it is left in Still mode for more than 5 minutes.

Video Search

Available mode:
Tape Playback

The video search function makes it easy to search for a desired scene on the tape.

Searching for a Scene Near the Current Tape Position

- 1 During Tape Playback, press \triangleright (or \triangleleft) on the Operation button.
 - The playback picture fast forwards (or reverses).

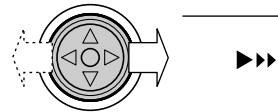

- 2 When you find the scene, press Δ to return to normal playback.

Searching for a Scene Far from the Current Tape Position

- 1 During fast forward (or rewind) in Tape Playback mode, press and hold \triangleright (or \triangleleft) on the Operation button.
 - The fast forward (or rewind) picture displays.
- 2 If the scene is still rather far from the current tape position, release the Operation button to normal fast forward (or rewind).
- 3 Repeat steps 1 and 2 above until you find the scene.
- 4 Press Δ to begin normal playback.

Notes:

- The sound is off during search.
- You may experience picture noise during search. This is not a malfunction.

Using Earphones (Commercially Available)

Available modes:

Tape Playback, Tape Camera

You can monitor the sound via stereo earphones (commercially available) during playback or recording. Stereo earphones with a 3.5 mm diameter plug can be used with this camcorder.

Connect the plug of stereo earphones to the earphones jack on the camcorder as shown below.

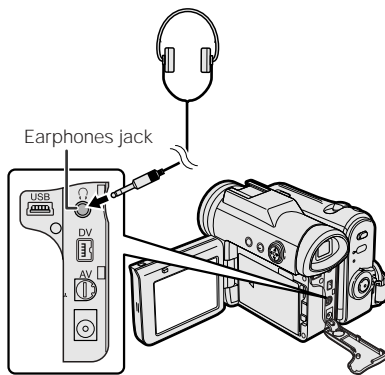

Notes:

- Before connecting stereo earphones, turn the camcorder volume down to the lowest setting.
- The built-in speaker automatically turns off when stereo earphones are connected to the earphones jack.

Adjusting the Phones Volume

Available mode:

Tape Camera

You can adjust the phones volume if sound through the earphones is difficult to hear.

- 1 Set the Media Selection switch to ∇ , then hold down the Lock button and set the Power switch to \blacksquare (see page 21).
- 2 Press the DISPLAY button until the mode screen appears (see page 31).
- 3 Press ∇ or Δ on the Operation button to select "MENU", then press the center of the Operation button.
- 4 Press ∇ or Δ to select "EXECUTE", then press the center of the Operation button.
- 5 Press ∇ or Δ to select \checkmark 1, then press the center of the Operation button.

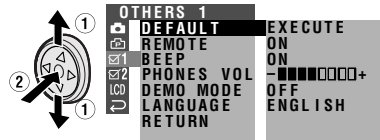

- 6 Press ∇ or Δ to select "PHONES VOL", then press the center of the Operation button.
- 7 Press \triangleleft or \triangleright to adjust to the desired volume level, then press the center of the Operation button.

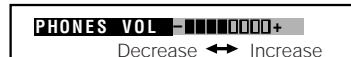

- 8 Press the DISPLAY button to turn off the menu screen.

Basic Operations Playback

Watching Playback on a TV

Available modes:

Tape Playback, Card Playback

You can connect the camcorder to a TV to allow a larger audience to enjoy playback.

- 1 Open the terminal cover on the camcorder (see page 2).

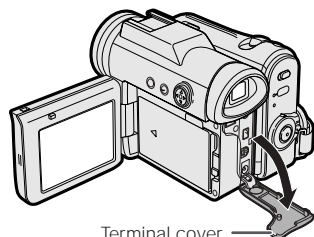

- 2 Connect the camcorder to your TV (or VCR) with the supplied audio/video/S-video cable, as shown.

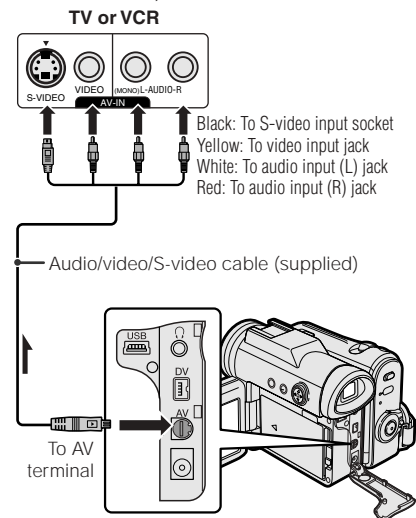

← The arrow shows the signal flow.

Note:

- Check that the camcorder, TV, VCR and other equipment to be used are turned off before making any connections. Picture noise or malfunction may occur if any of the above is left on while making a connection.

- 3 Turn on the TV and set it to the "AV" or "VIDEO" channel. (See the operation manual of your TV.)
 - When connecting to a TV via a VCR, turn on the VCR and set it to the "AV" or "LINE" input channel. Operate the TV as you normally do to view the signal from the VCR. (See the operation manuals of your TV and VCR.)
- 4 Set the Power switch on the camcorder to , and begin playback (see page 27).

Notes:

- If your TV or VCR has only one audio input jack, use the white plug for the audio connection on the TV or VCR.
- If your TV or VCR has an S-video input socket, you do not need to connect the yellow video plug.
- Close the terminal cover after use.

About the S-video socket

S-video sockets are used to separately pass the chroma (color) and luminance (brightness) components of video signals. They serve to improve the picture quality in both recording and playback.

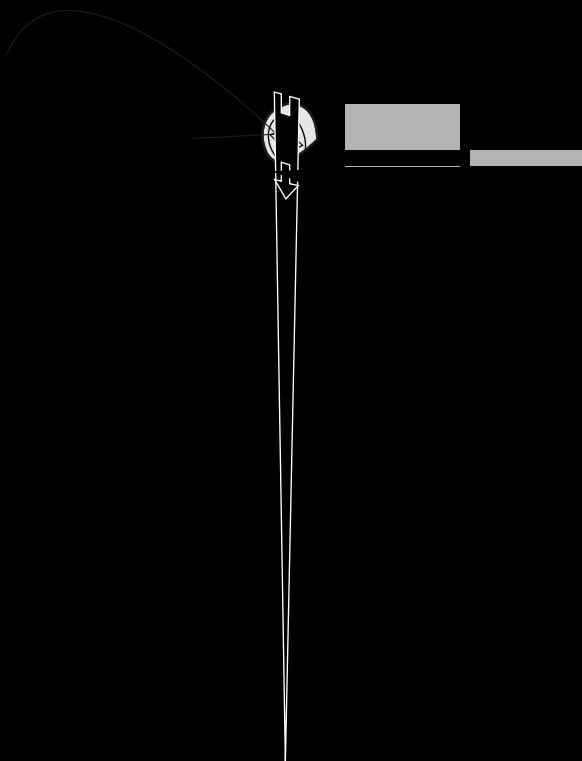

Useful Features

Using the Menu Screens

Use the menu screens to adjust the various camcorder settings.

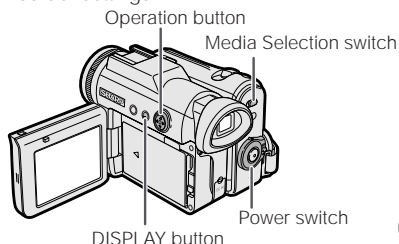

- 1 Set to the desired camcorder mode by using the Media Selection switch and the Power switch (see page 21).
 - See pages 106 to 109 for the menu items you can select in each camcorder mode.
 - Steps 2 to 8 show how to change the DGTL ZOOM menu setting in Tape Camera mode.
- 2 Press the DISPLAY button until the mode screen appears (see page 31).
- 3 Press ∇ or Δ on the Operation button to select "MENU", then press the center of the Operation button.
- 4 Press ∇ or Δ to select "EXECUTE", then press the center of the Operation button.

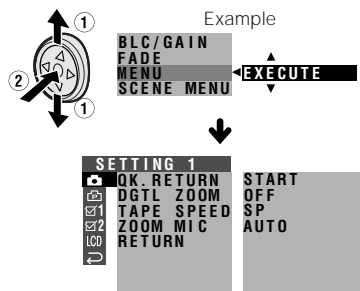

- Note:**
- The menu screen does not appear during recording.

- 5 Press ∇ or Δ to select the desired menu screen (T), then press the center of the Operation button.

Example

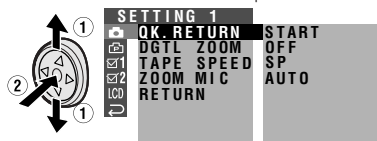

- You can press \triangleright , instead of the center of Operation button.

- 6 Press ∇ or Δ to select the desired menu item (DGTL ZOOM), then press the center of the Operation button.

Example

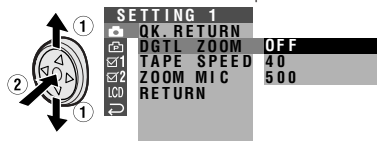

- You can press \triangleright , instead of the center of the Operation button.

- 7 Press ∇ or Δ to select the desired menu setting (40), then press the center of the Operation button.

DGTL ZOOM 40

- You can press \triangleleft , instead of the center of the Operation button.
- To adjust another menu item, press ∇ or Δ to select "RETURN" and press the center of the Operation button, then perform steps 5 to 7.

- 8 Press the DISPLAY button to turn off the menu screen.

Notes:

- Certain menu items are common to all camcorder modes. If the BEEP menu item, for example, is set to "OFF" in Tape Camera mode, it will be automatically set to "OFF" in other modes.
- The menu screen automatically turns off if no settings are made within 5 minutes.
- Items that are not selectable are grayed out.

Useful Features

Camera Recording

Setting the Digital Zoom

Available mode:
Tape Camera

You can select three different zoom ranges: 1-10K (optical zoom), 10-40K (digital zoom) or 10-500K (digital zoom). The digital zoom allows you to record powerful close-up pictures with the same operation as normal zooming.

Notes:

- The digital zoom is in addition to the optical zoom giving a combined maximum zoom range of 1-500K .
- **As the image is enlarged digitally, the picture quality decreases when higher digital zoom settings are used.**

- 1 In Tape Camera mode, press the DISPLAY button until the mode screen appears.



- 2 Press ∇ or Δ on the Operation button to select "MENU", then press the center of the Operation button.
- 3 Press ∇ or Δ to select "EXECUTE", then press the center of the Operation button.
- 4 Press ∇ or Δ to select T , then press the center of the Operation button.

- 5 Press ∇ or Δ to select "DGTL ZOOM", then press the center of the Operation button.

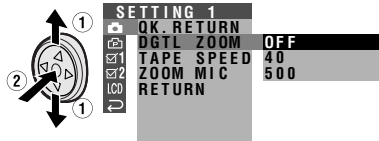

- 6 Press ∇ or Δ to select "40" or "500", then press the center of the Operation button.

DGTL ZOOM 40

- 7 Press the DISPLAY button to turn off the menu screen.

The "D" digital zoom indicator is displayed during digital zooming.

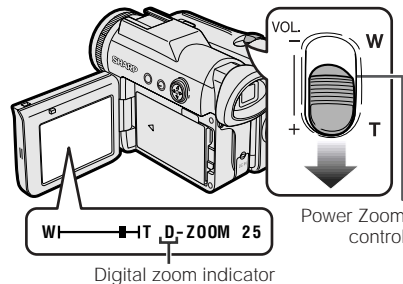

To use optical zoom only

Select "OFF" in step 6 above.

Useful Features Camera Recording

Backlight Compensation (BLC)

Available modes:

Tape Camera, Card Camera

When the subject is backlit, the image will appear dark if it is recorded normally. Use the backlight compensation (BLC) function to improve the picture.

- The example screens shown are for Tape Camera mode.

- 1 In Tape Camera or Card Camera mode, press the DISPLAY button until the mode screen appears.



- 2 Press ∇ or Δ on the Operation button to select "BLC/GAIN", then press the center of the Operation button.
- 3 Press ∇ or Δ to select "ON x", then press the center of the Operation button.



- 4 Press the DISPLAY button to turn off the mode screen.

- "x" appears when on-screen indicators are turned on, indicating that the backlight compensation is now working.



To cancel the backlight compensation function

Select "OFF" in step 3 above.

Gain-up

Available modes:

Tape Camera, Card Camera

When you are recording in a dark or poorly illuminated location, "LIGHT" is displayed on the screen. Use the gain-up function to record a brighter picture.

Note:

- At locations where lighting is adequate, "LIGHT" will not appear. The gain-up function cannot be used in this case.
- The example screens shown are for Tape Camera mode.

- 1 In Tape Camera or Card Camera mode, press the DISPLAY button until the mode screen appears.



- 2 Press ∇ or Δ on the Operation button to select "BLC/GAIN", then press the center of the Operation button.
- 3 Press ∇ or Δ to select "ON ⏏ ", then press the center of the Operation button.



- 4 Press the DISPLAY button to turn off the mode screen.
 - " ⏏ " appears when on-screen indicators are turned on, indicating that the gain-up function is now working.

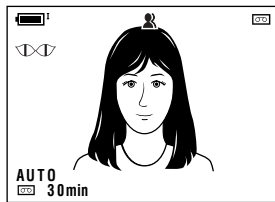

To cancel the gain-up function

Select "OFF" in step 3 above.

Notes:

- You may experience some picture noise in Gain-up mode, which increases when the ⏏ appears.
- When the ⏏ indicator appears, you may get a shadow image behind a subject that is moving around a lot.
- Fine brightness adjustments are possible when using manual iris (see page 56).
- The ⏏ indicator will disappear and Gain-up mode will cancel if you aim the camcorder in a bright location.

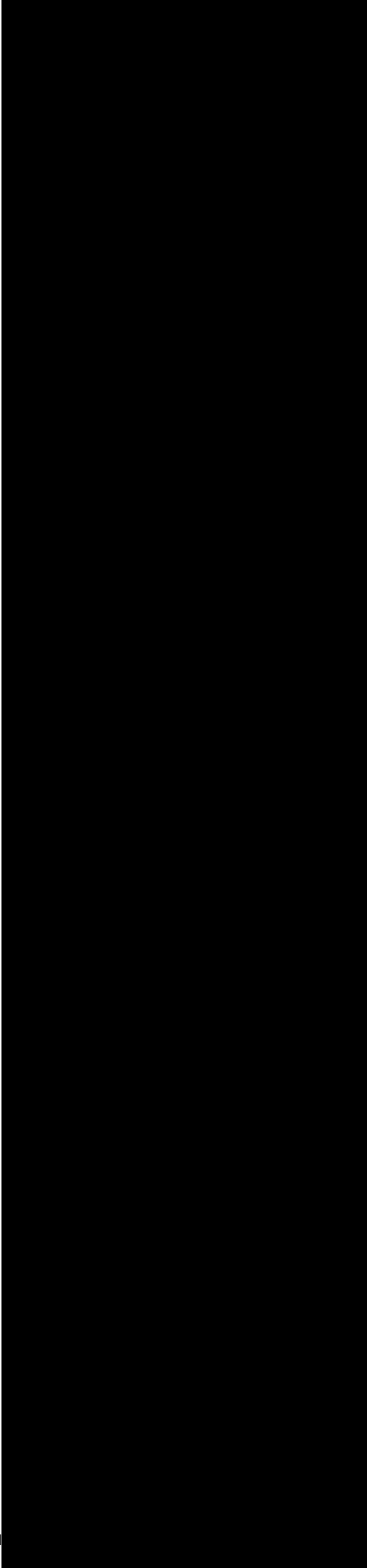

Quick Return

Available mode:

Tape Camera

If while playing back your tape you want to quickly return to the last recorded scene and start recording again, use the quick return function.

- 1 Set the camcorder to Tape Camera mode.
- 2 In Recording Standby mode, press the DISPLAY button until the mode screen appears.
- 3 Press ∇ or Δ on the Operation button to select "MENU", then press the center of the Operation button.
- 4 Press ∇ or Δ to select "EXECUTE", then press the center of the Operation button.
- 5 Press ∇ or Δ to select T , then press the center of the Operation button.
- 6 Press ∇ or Δ to select "QK. RETURN", then press the center of the Operation button.

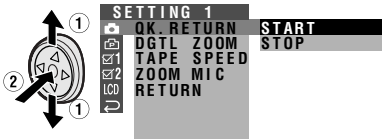

- 7 Press ∇ or Δ to select "START", then press the center of the Operation button.

- "SEARCH" flashes, and the tape begins fast forwarding or rewinding to the end of the last recorded scene.



- When the tape reaches the end of the last recorded scene, "FINISHED" is displayed, and the camcorder enters Recording Standby mode.

- 8 Press the DISPLAY button to turn off the menu screen.

Notes:

- To cancel the quick return function while "SEARCH" is flashing, press the center of Operation button twice.
- Quick return will not work if you remove the cassette and reload it after recording or if nothing has been recorded since loading.

Digital Image Stabilization (DIS)

Available mode:
Tape Camera

The digital image stabilization (DIS) function allows you to stabilize the image by electronically compensating for relatively minor image shaking that is often annoying in close-up shots.

- 1 In Tape Camera mode, press the DISPLAY button until the mode screen appears.
- 2 Press ∇ or Δ on the Operation button to select "MENU", then press the center of the Operation button.
- 3 Press ∇ or Δ to select "EXECUTE", then press the center of the Operation button.
- 4 Press ∇ or Δ to select Υ , then press the center of the Operation button.
- 5 Press ∇ or Δ to select "DIS", then press the center of the Operation button.

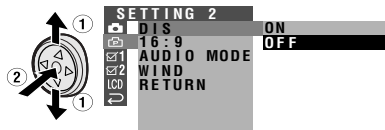

- 6 Press ∇ or Δ to select "ON", then press the center of the Operation button.

DIS ON

- 7 Press the DISPLAY button to turn off the menu screen.
 - The DIS indicator only appears when the on-screen indicators are turned on.

DIS indicator

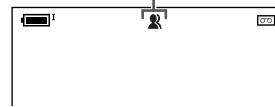

To cancel DIS function

Select "OFF" in step 6 above. The z indicator will disappear.

Notes:

- The DIS function cannot compensate for excessive image shaking.
- When image shaking does not occur (e.g. when using the camcorder on a tripod), turn off the DIS function. The picture will appear more natural when the DIS function is off.

Useful Features Camera Recording

Self Recording

Normal self recording

Available modes:

Tape Camera, Card Camera

Open the LCD monitor and rotate it 180° vertically so that the screen faces the other way and the subject can monitor the shot while you are recording with the viewfinder.



If the camcorder is steadied, you can record yourself in the scene by watching yourself on the LCD monitor. The remote control is useful for such occasions.

Useful Features

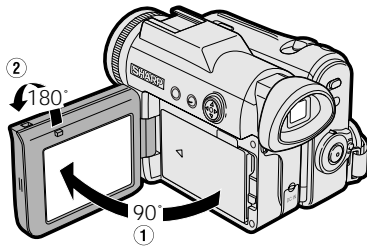

- 1 Pull out the viewfinder completely. Open the LCD monitor to a 90° angle to the camcorder body (1), and then rotate it 180° vertically (2).



- 2 Set the Media Selection switch to V or .
- 3 Set the Power switch to .
 - The subject is displayed in the viewfinder, and a mirror image of the subject is displayed on the LCD monitor.

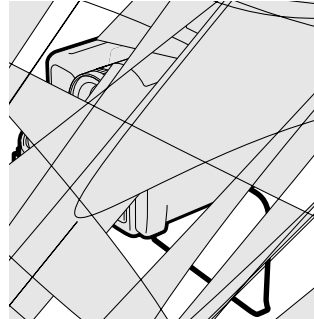

- 4 Begin recording.

Notes:

- Use the remote control to begin/stop recording on tape.
- You can play back images while the monitor is in the self recording position. Set the camcorder to Tape Playback or Card Playback mode.

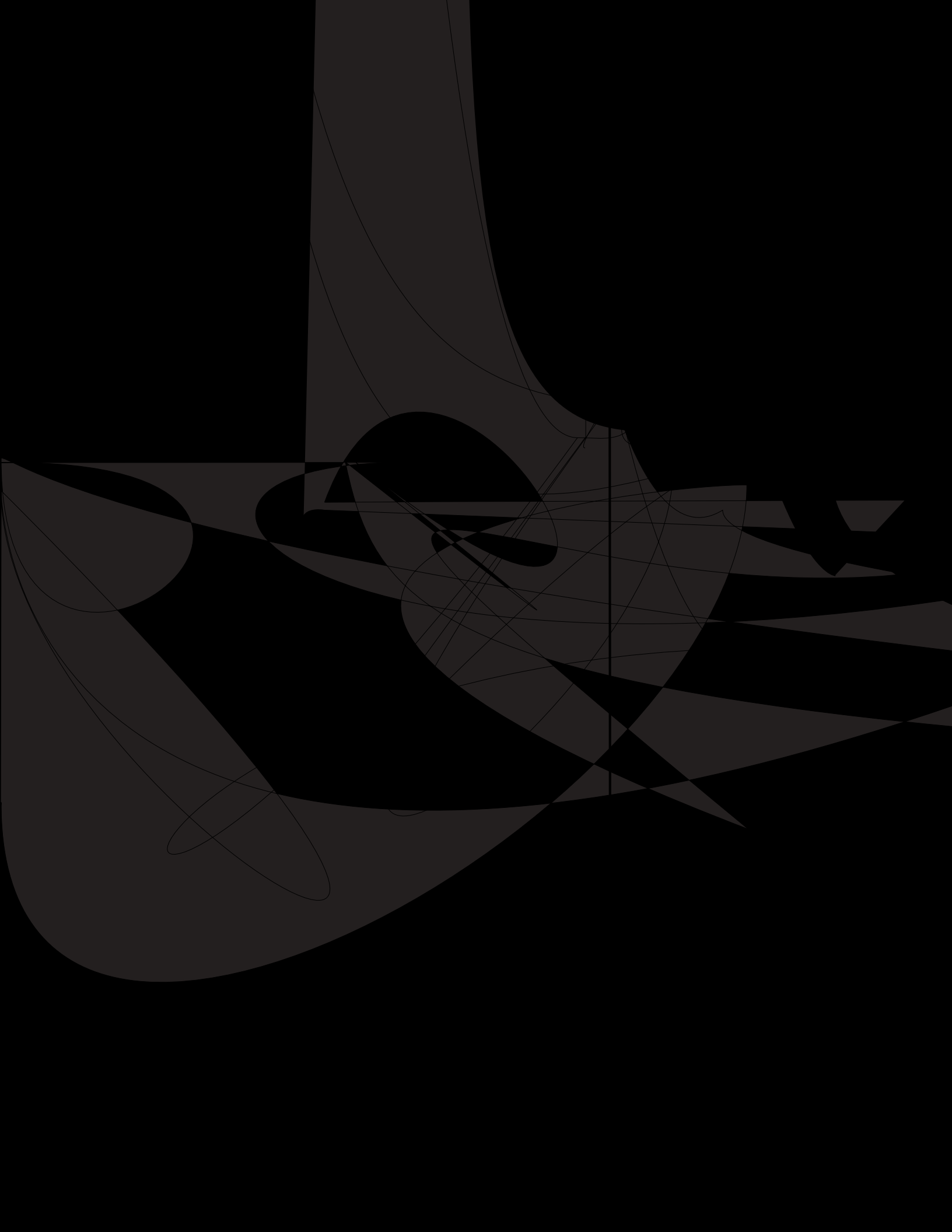

Useful Features Camera Recording

Wide Screen (16:9)

Available mode:

Tape Camera

The wide screen function lets you record scenes with the wide-screen feel of a movie shown in a theater. The top and bottom of the picture are masked with black bands to produce an effective screen aspect ratio of 16:9.

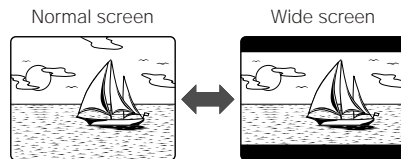

- 1 In Tape Camera mode, press the DISPLAY button until the mode screen appears.



- 2 Press ∇ or Δ on the Operation button to select "MENU", then press the center of the Operation button.
- 3 Press ∇ or Δ to select "EXECUTE", then press the center of the Operation button.
- 4 Press ∇ or Δ to select Y, then press the center of the Operation button.

- 5 Press ∇ or Δ to select "16:9", then press the center of the Operation button.

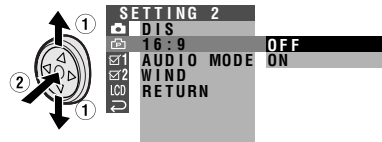

- 6 Press ∇ or Δ to select "ON", then press the center of the Operation button.
 - The picture is displayed with the top and bottom portions masked.

16:9 ON

- 7 Press the DISPLAY button to turn off the menu screen.

To return to normal screen

Select "OFF" in step 6 above.

Recording in LP (Long Play Recording) Mode

Available mode:
Tape Camera

This camcorder allows you to record in LP (Long Play Recording) mode for approximately 50% more recording time with the same picture quality as that in SP (Standard Play Recording) mode.

- 1 In Tape Camera mode, press the DISPLAY button until the mode screen appears.
- 2 Press ∇ or Δ on the Operation button to select "MENU", then press the center of the Operation button.
- 3 Press ∇ or Δ to select "EXECUTE", then press the center of the Operation button.
- 4 Press ∇ or Δ to select T, then press the center of the Operation button.
- 5 Press ∇ or Δ to select "TAPE SPEED", then press the center of the Operation button.

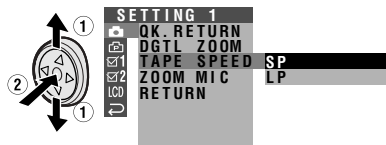

- 6 Press ∇ or Δ to select "LP", then press the center of the Operation button.

TAPE SPEED LP

- 7 Press the DISPLAY button to turn off the menu screen.
 - The long play recording mode indicator only appears when the on-screen indicators are turned on.



Long play recording mode indicator

To return to SP mode

Select "SP" in step 6 above.

Notes on the use of LP mode

- To record in LP mode, be sure to use a Mini DV cassette labeled for use with LP mode.
- Frozen images, mosaic-pattern picture noise, audio interruptions or audio loss may occur in the following cases:
 - When using a tape which is not designated for use with LP mode.
 - When a tape recorded in LP mode under high temperature conditions is played back.
 - When a tape recorded in LP mode with the camcorder is played back on a Mini DV player or camcorder from another manufacturer.
 - When a tape recorded in LP mode is played back on a Mini DV player or camcorder without an LP function.
- Audio dubbing is not possible with LP mode recording.

Useful Features Camera Recording

Using the Zoom Microphone (Optional Accessory)

Available mode
Tape Camera

With the optional zoom microphone VR-8MCN, you can record audio according to the magnification of the zoom lens for producing the optimum sound.

Mounting

- 1 After detaching the shoe cover, align the zoom microphone with the zoom microphone shoe on the camcorder, and slide it in the direction of the arrow until it locks into place.

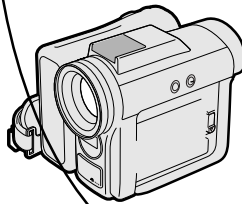

- 2 Turn the screw in the direction of the arrow to secure the microphone.

Removing

Turn the screw in the opposite direction than when mounting, then pull off the zoom microphone.

Notes:

- Do not pick up the camcorder by the zoom microphone, as this may damage the equipment.
- The zoom microphone shoe on the camcorder is designed only for use with the specified equipment.
- When not using the zoom microphone, be sure to attach the shoe cover for protecting the zoom microphone shoe.

Selecting the Zoom Microphone Mode

Select a zoom microphone mode when the zoom microphone is mounted.

Types

AUTO: The camcorder automatically selects the optimum sound according to the magnification of the zoom lens. When the zoom lens is at a wide-angle setting, the built-in microphone is used to record sounds. As the zoom magnification increases, the sounds from the zoom microphone and built-in microphone are mixed according to the zoom setting.

TELE: The zoom microphone is fixed to record sounds at a distance. (The built-in microphone is turned off.)

OFF: The zoom microphone is turned off. (The built-in microphone is on.)

- 1 Mount the optional zoom microphone to the camcorder.
- 2 In Tape Camera mode, press the DISPLAY button until the mode screen appears (see page 31).
- 3 Press ∇ or Δ on the Operation button to select "MENU", then press the center of the Operation button.
- 4 Press ∇ or Δ to select "EXECUTE", then press the center of the Operation button.
- 5 Press ∇ or Δ to select T, then press the center of the Operation button.
- 6 Press ∇ or Δ to select "ZOOM MIC", then press the center of the Operation button.

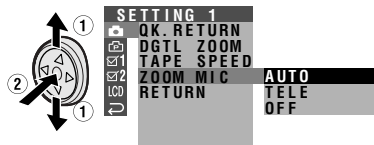

- 7 Press ∇ or Δ to select the desired zoom microphone mode, then press the center of the Operation button.

ZOOM MIC TELE

- 8 Press the DISPLAY button to turn off the menu screen.

When the zoom microphone is active, the zoom microphone indicator appears and the zoom range indicator changes as shown below.

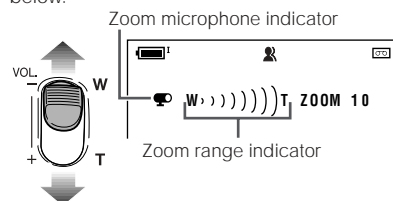

Windbreak

Available mode:

Tape Camera

The windbreak function allows you to reduce annoying noise from strong winds when recording.

- 1 In Tape Camera mode, press the DISPLAY button until the mode screen appears (see page 31).
- 2 Press ∇ or Δ on the Operation button to select "MENU", then press the center of the Operation button.
- 3 Press ∇ or Δ to select "EXECUTE", then press the center of the Operation button.
- 4 Press ∇ or Δ to select Y, then press the center of the Operation button.
- 5 Press ∇ or Δ to select "WIND", then press the center of the Operation button.

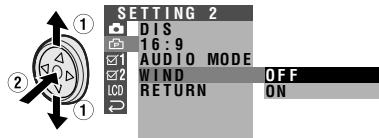

- 6 Press ∇ or Δ to select "ON", then press the center of the Operation button.

WIND ON

- 7 Press the DISPLAY button to turn off the menu screen.

To cancel Windbreak

Select "OFF" in step 6 above.

Note:

- Keep the windbreak function off during normal recording. If left on, the recorded audio may sound somewhat muffled when played back.

Useful Features Camera Recording

Selecting the 16-bit Audio Recording Mode

Available mode:
Tape Camera

The camcorder normally records audio in the 12-bit audio recording mode. For higher-quality audio recording, select the 16-bit audio recording mode.

- 1 In Tape Camera mode, press the DISPLAY button until the mode screen appears (see page 31).
- 2 Press ∇ or Δ on the Operation button to select "MENU", then press the center of the Operation button.
- 3 Press ∇ or Δ to select "EXECUTE", then press the center of the Operation button.
- 4 Press ∇ or Δ to select Y, then press the center of the Operation button.
- 5 Press ∇ or Δ to select "AUDIO MODE", then press the center of the Operation button.

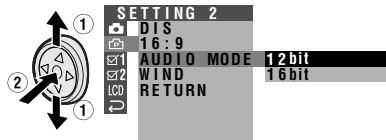

- 6 Press ∇ or Δ to select "16bit", then press the center of the Operation button.

AUDIO MODE 16 bit

- 7 Press the DISPLAY button to turn off the menu screen.
 - The 16-bit audio recording mode indicator only appears when the on-screen indicators are turned on.



16-bit audio recording mode indicator

To return to 12-bit audio recording mode

Select "12bit" in step 6 above.

Note:

- When using Audio Dubbing with 16-bit audio recordings, both the dubbed and original sounds will be recorded in mono (see page 68).

Useful Features

Playback

Using the Remote Control

Available modes:
All modes

Use the remote control to operate the camcorder from a distance, such as when you want to record yourself in a scene, or when the camcorder is connected to a TV for use as a VCR.

Activating

- The example screens shown are for Tape Playback mode.

- Press the DISPLAY button until the mode screen appears.
- Press ∇ or Δ on the Operation button to select "MENU", then press the center of the Operation button.
- Press ∇ or Δ to select "EXECUTE", then press the center of the Operation button.
- Press ∇ or Δ to select \checkmark 1, then press the center of the Operation button.
- Press ∇ or Δ to select "REMOTE", then press the center of the Operation button.

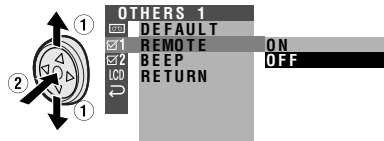

- Press ∇ or Δ to select "ON", then press the center of the Operation button.

REMOTE ON

- Press the DISPLAY button to turn off the menu screen.

Operating

Aim the remote control at the remote sensor of the camcorder, and press the control buttons to operate.

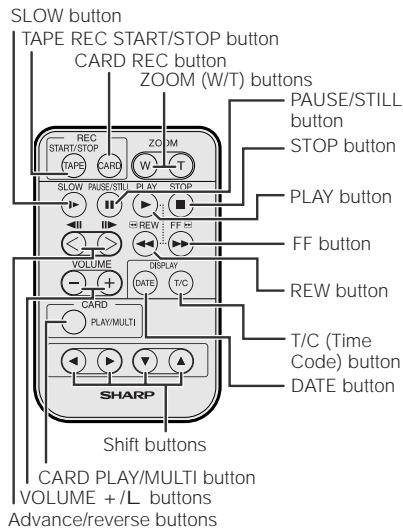
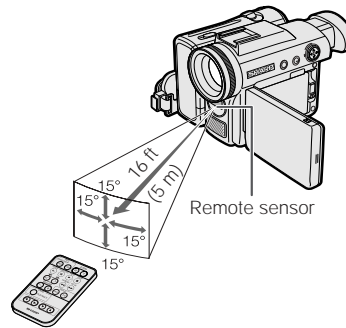

Notes:

- Be careful not to expose the remote sensor to direct sunlight or strong interior lighting, as this may prevent the remote control from operating properly.
- Be sure that there are no obstacles between the remote control and the remote sensor.

Useful Features Playback

Tape Playback Functions with the Remote Control

Available mode:
Tape Playback

You can use the following playback functions with the supplied remote control. (See page 47 for use of the remote control.)

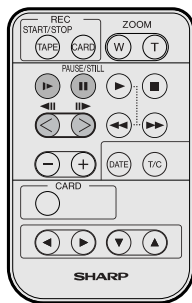

Useful Features

The reverse playback function allows you to play back images in reverse.

During Tape Playback, press the **j** button.

Slow

The slow function allows you to play back images in slow motion.

During Tape Playback, press the SLOW button (**f**). Then, select the tape direction using the advance/reverse buttons (**j** or **h**).

To return to normal playback, press the PLAY button (**t**).

Note:

- To protect the tape, the camcorder automatically returns to normal playback if it is left in Slow mode for more than 10 minutes.

Frame Advance

The frame advance function allows you to play back still images frame by frame.

1 During Tape Playback, press the PAUSE/STILL button (**g**) to pause playback.

2 Press the **h** (or **◀**) button.

- Each time you press the button, the picture advances one frame forward (or backward).

To return to normal playback, press the PLAY button (**t**).

Notes:

- The sound is off during reverse, slow, and frame advance playback.
- If you use the slow or frame advance function with the tape recorded in LP mode, the picture may advance several frames at a time.
- The reverse frame advance moves about 30 frames.

Selecting the Date and Time of Recording Display

Available modes:
All modes

Follow the procedure below to select the date, or both the date and time, of recording display on the screen. You can display the date and time during both recording and playback.

- The example screens shown are for Tape Playback mode.

- Hold down the Lock button and set the Power switch to or .
- Press the DISPLAY button until the mode screen appears.



- Press ∇ or Δ on the Operation button to select "DATE DISP.," then press the center of the Operation button.



- Press ∇ or Δ to select the desired setting, then press the center of the Operation button.

DATE DISP. ▶ DATE

- Each time you press ∇ or Δ , the setting changes as shown below.



- Press the DISPLAY button until the date (or date and time) appears.



Notes:

- The date (or date and time) appears when the on-screen indicators are turned on.**
- Before recording, make sure that the date and time have been correctly set. If they have not been set, the display will be left blank when playing back the recording. (The display will also be left blank for unrecorded or damaged portions of the tape.)
- In Tape Playback mode, the current date and time are displayed when the tape is not being played back.
- You can also press the DATE button on the remote control to display the date (or date and time).

Useful Features Playback

Picture Effect Playback

Available modes:

Tape Playback, Card Playback

These picture effects let you play back images with a more dramatic effect.

Types

B/W: The picture is displayed in black-and-white.

SEPIA: The picture is displayed in sepia color similar to that of an old photograph.

SOLARI: The contrast of the subject is enhanced, creating a unique artistic image.

NEGA: The blacks and whites of the image are reversed and colors of the image are inverted.

- The example screens shown are for Tape Playback mode.

- 1 During Tape Playback (or Card Playback), press the DISPLAY button until the mode screen appears.
- 2 Press ∇ or Δ on the Operation button to select "PIC. EFFECT", then press the center of the Operation button.



- 3 Press ∇ or Δ to select the desired picture effect, then press the center of the Operation button.

PIC. EFFECT \blacktriangleright B/W

- 4 Press the DISPLAY button to turn off the mode screen.

To cancel Picture Effect Playback

Select "OFF" in step 3 above.

Notes:

- Video images in Picture Effect Playback mode cannot be transferred via DV cable to a personal computer.
- You cannot use Picture Effect Playback with Slide Show Playback.

Rotate Playback

Available mode:
Tape Playback

This function allows you to play back images rotated 180°.

- 1 In Tape Playback mode, press the DISPLAY button until the mode screen appears.
- 2 Press ∇ or Δ on the Operation button to select "MENU", then press the center of the Operation button.
- 3 Press ∇ or Δ to select "EXECUTE", then press the center of the Operation button.
- 4 Press ∇ or Δ to select ∇ , then press the center of the Operation button.
- 5 Press ∇ or Δ to select "ROTATE PB", then press the center of the Operation button.

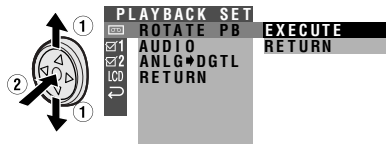

- 6 Press ∇ or Δ to select "EXECUTE", then press the center of the Operation button.
 - Rotate Playback indicator appears.

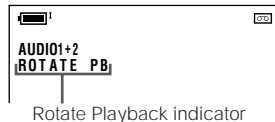

- 7 Press Δ to begin Rotate Playback.
 - The image is rotated 180° upside down.

To cancel Rotate Playback

Press the center of the Operation button in step 7 above.

Notes:

- When executing Rotate Playback during Tape Playback, playback will stop. Press Δ to begin Rotate Playback.
- Even if the camcorder is in Rotate Playback mode, the image output via a DV connection will display as normal playback.
- The camcorder will stop and cancel Rotate Playback when the LCD monitor is closed.
- When you want to display the menu screen during Rotate Playback, press the center of the Operation button.
- In Rotate Playback mode, you cannot perform frame advance, slow, and picture effect playback or copying an image from tape to card.

Useful Features Playback

Copying an Image from Tape to Card

Available mode:
Tape Playback

You can capture your favorite image frame from a video tape recording and save it on card.

PHOTO button

Operation button

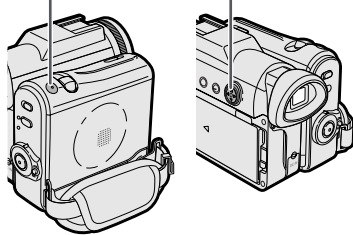

Useful Features

- 1 Insert the recorded Mini DV cassette and a card in the camcorder.
- 2 Set the camcorder to Tape Playback mode, then begin tape playback.
- 3 Press Δ on the Operation button at the point where the desired image appears.
 - A still picture of the image appears.

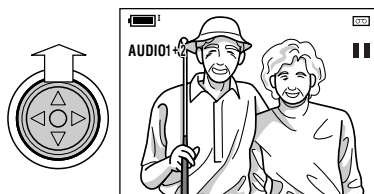

Note:

- To cancel the still picture, press Δ again.

- 4 Press the PHOTO button to copy the image to the card.
 - The S indicator flashes red while the image is copied.

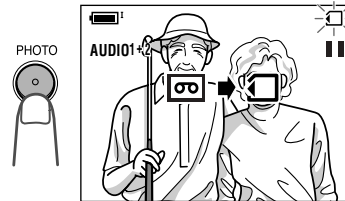

Ma

Availab

Tap

Al

Advanced Features Camera Recording

Returning to Auto Focus

Available modes:

Tape Camera, Card Camera

You can set Manual Focus mode to Auto Focus mode with the operation below.

- The example screens shown are for Tape Camera mode.

- 1 In Tape Camera or Card Camera mode, press the DISPLAY button until the mode screen appears.
- 2 Press ∇ or Δ on the Operation button to select "AUTO FOCUS", then press the center of the Operation button.



- 3 Press ∇ or Δ to select "EXECUTE", then press the center of the Operation button.
 - The FOCUS setting returns to Auto Focus mode.
- 4 Press the DISPLAY button to turn off the mode screen.

Advanced Features

Displaying the Manual Setting Screen

Available modes:

Tape Camera, Card Camera

You can manually adjust these settings as shown below in the manual setting screen.

- White Balance (see page 55)
- Manual Iris (see page 56)
- Manual Gain (see page 57)

- The example screens shown are for Tape Camera mode.

- 1 In Tape Camera or Card Camera mode, press the DISPLAY button until the mode screen appears.
- 2 Press ∇ or Δ on the Operation button to select "MANUAL SET", then press the center of the Operation button.



- 3 Press ∇ or Δ to select "EXECUTE", then press the center of the Operation button.

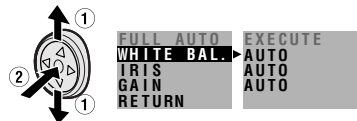

Notes:

- Tape Camera and Card Camera mode do not share manual settings.
- Items that are not selectable are grayed out.

White Balance Lock

Available modes:

Tape Camera, Card Camera

The color of the subject on the screen looks different depending on lighting conditions. Lock the White Balance if the Auto White Balance does not work properly.

- 1 In Tape Camera or Card Camera mode, press the DISPLAY button until the mode screen appears.
- 2 Press ∇ or Δ on the Operation button to select "MANUAL SET", then press the center of the Operation button (see page 54).
- 3 Press ∇ or Δ to select "EXECUTE", then press the center of the Operation button.
- 4 Press ∇ or Δ to select "WHITE BAL.", then press the center of the Operation button.

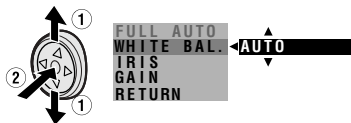

- 5 Press ∇ or Δ to select "LOCK MODE".



- 6 Aim the lens at a white object.

White paper or white cloth

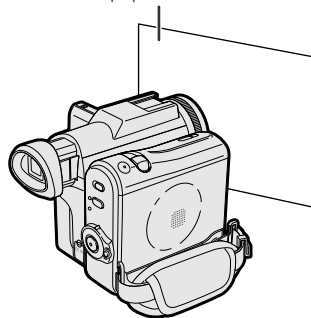

- Adjust the distance of the object so that the entire screen is white.

- 7 Press the center of the Operation button to set the white balance lock.
 - "LOCK MODE" will change to "LOCK" after pressing the center of the Operation button.
 - "LOCK" flashes during the locking procedure, and stops flashing after locking the white balance.

Note:

- If you move the camcorder while "LOCK" is flashing, "LOCK" may not stop flashing. If this occurs, repeat step 7.

- 8 Press the DISPLAY button to turn off the MANUAL SET screen.

To return to Auto White Balance mode

Press \triangleright in step 5 above, then press the center of the Operation button.

To return to Full Auto mode

Set the camcorder to Full Auto mode (see page 58).

Note:

- White Balance setting cannot be used when a scene setting is selected.

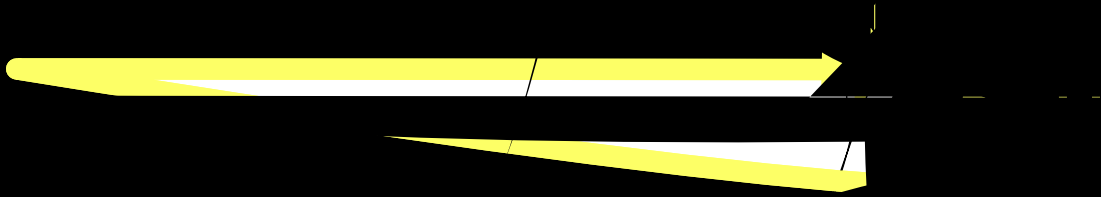

Manual Gain

Available modes:

Tape Camera, Card Camera

When recording in a dark or poorly illuminated location with Auto Gain mode, the light sensitivity of the camcorder (gain) will be automatically adjusted and the recorded image may be brighter than the subject actually is. If you want to faithfully record a dark scene in this case, use the manual gain function. You can also adjust the gain to record a backlit subject brighter.

Example of use

Faithfully recording a dark scene

- Select a smaller gain value (to decrease the light sensitivity).

Background is too bright and subject is too dark (backlit subject)

- Select a larger gain value (to increase the light sensitivity).

- 1 In Tape Camera or Card Camera mode, press the DISPLAY button until the mode screen appears.
- 2 Press ∇ or Δ on the Operation button to select "MANUAL SET", then press the center of the Operation button (see page 54).
- 3 Press ∇ or Δ to select "EXECUTE", then press the center of the Operation button.

- 4 Press ∇ or Δ to select "GAIN", then press the center of the Operation button.



- 5 Press ∇ or Δ to select the desired gain value, then press the center of the Operation button.



- The number shown is the selected gain value. The adjustment range is 7 steps from 0dB (lowest sensitivity) to L 18dB (highest sensitivity).

Note: If you select a large gain value, the image may appear grainy.

- 6 Press the DISPLAY button to turn off the MANUAL SET screen.

To return to Auto Gain mode

Press \triangleright in step 5 above, then press the center of the Operation button.

To return to Full Auto mode

Set the camcorder to Full Auto mode (see page 58).

Note:

- Manual Gain mode cannot be used when a scene setting is selected.

Advanced Features Camera Recording

Setting the Camcorder to Full Auto Mode

Available modes:

Tape Camera, Card Camera

You can set all manual settings, including white balance, iris, gain, but not focus, to Full Auto mode in one operation.

- 1 In Tape Camera or Card Camera mode, press the DISPLAY button until the mode screen appears.
- 2 Press ∇ or Δ on the Operation button to select "MANUAL SET", then press the center of the Operation button (see page 54).
- 3 Press ∇ or Δ to select "EXECUTE", then press the center of the Operation button.



- 4 Press ∇ or Δ to select "FULL AUTO", then press the center of the Operation button.



- 5 Press ∇ or Δ to select "EXECUTE", then press the center of the Operation button.



- 6 Press the DISPLAY button to turn off the MANUAL SET screen.

Note:

- You cannot select "FULL AUTO" when no manual settings are currently in use.

Scene Menu (Program AE)

Available modes:

Tape Camera, Card Camera

You can set the camcorder to a shooting mode that will create the best results for a specific situation. Just select one of the six scene settings shown below. The camcorder will automatically set the exposure, white balance, and shutter speed to produce the optimum picture quality for the selected situation.

Types

SPORT (⚡): When you want to record a fast-moving subject.

DUSK (🌇): When you want to faithfully record the red of the setting sun, and the surrounding twilight.

SUNLIGHT (☀): When background is very bright.

PARTY (🎉): When the illumination is from a spotlight or candle.

NIGHT LUMI (🌃): When you want to record fireworks or an illuminated object in the dark.

SLOW SHUT. (🐢): When you want to record an object in a dim place and make it emerge brightly.

• The example screens shown are for Tape Camera mode.

1 In Tape Camera or Card Camera mode, press the DISPLAY button until the mode screen appears.

2 Press ∇ or Δ on the Operation button to select "SCENE MENU", then press the center of the Operation button.



3 Press ∇ or Δ to select the scene setting that best fits the recording situation, then press the center of the Operation button.

• The selected scene setting displays on the mode screen.

SCENE MENU ▶ DUSK

4 Press the DISPLAY button to turn off the mode screen.

• The selected scene setting indicator displays when the on-screen indicators are turned on.

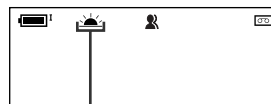

Scene setting indicator

To cancel the scene setting

Select "OFF" in step 3 above.

Note:

• Scene settings cannot be used when using any manual setting except focus. Also not selectable when $\nabla \Delta$ displays.

Advanced Features

Playback

Using the Time Code

Available modes:

Tape Camera, Tape Playback

The time code shows the hour, minute and second of recording, and the frame number (1 frame = approx. 1/30 sec.). This is automatically recorded along with the subject when you are recording on the tape. You can display the time code on the screen as an accurate counter in both Tape Playback and Tape Camera modes.

Display format

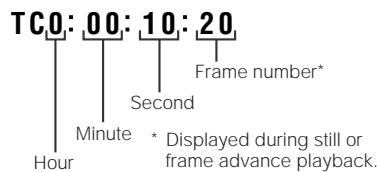

The example screens shown are for Tape Playback mode.

- 1 During playback or camera recording in Tape mode, press the DISPLAY button until the mode screen appears.
- 2 Select "MENU", then "EXECUTE" by using the Operation button (see page 32).
- 3 Press ∇ or Δ to select $\boxtimes 2$, then press the center of the Operation button.
- 4 Press ∇ or Δ to select "TIME CODE", then press the center of the Operation button.

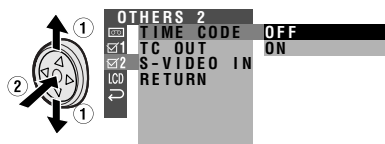

- 5 Press ∇ or Δ to select "ON", then press the center of the Operation button.

TIME CODE ON

- 6 Press the DISPLAY button to turn off the menu screen.

- The time code appears when the on-screen indicators are turned on.

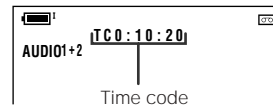

To turn off the time code

Select "OFF" in step 5 above.

Notes:

- When the tape reaches an unrecorded section, the time code returns to zero (TC0:00:00). Once recorded, the time code cannot be changed.
- You can also press the T/C button on the remote control to display the time code.

Displaying the time code on a TV during playback

- 1 In Tape Playback mode, press the DISPLAY button until the mode screen appears.
- 2 Select "MENU", then "EXECUTE" by using the Operation button (see page 32).
- 3 Press ∇ or Δ to select $\boxtimes 2$, then press the center of the Operation button.
- 4 Press ∇ or Δ to select "TC OUT", then press the center of the Operation button.

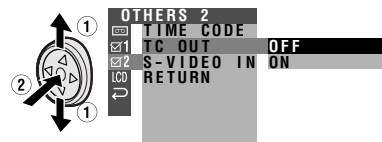

- 5 Press ∇ or Δ to select "ON", then press the center of the Operation button.

TC OUT ON

- 6 Press the DISPLAY button to turn off the menu screen.

Editing

Available mode:

Tape Playback

Video editing lets you refine your videos by removing unwanted sequences from your tape, or transposing one sequence with another.

This camcorder lets you monitor the source program on the built-in LCD monitor without having to connect it to an external TV or video monitor.

Preparation

Connect the camcorder to a VCR with the supplied audio/video/S-video cable, as shown.

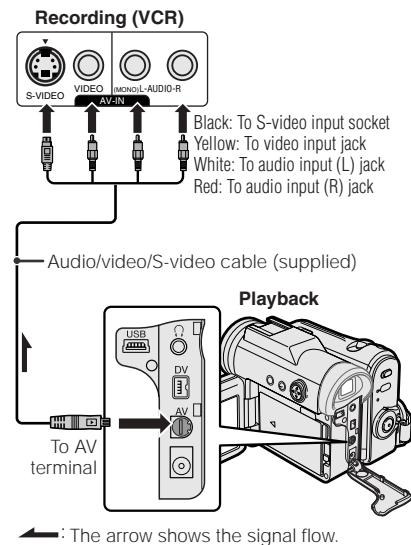

Notes:

- See page 2 for how to open the terminal cover.
- If your VCR has only one audio input jack, use the white plug for the audio connection on the VCR.
- If your VCR has an S-video input socket, you do not need to connect the yellow video plug.

Cutting Unwanted Sequences

- 1 Play back the tape to be edited on the camcorder, and locate the beginning and end of the sequence you wish to cut. Write down the time code reading at the beginning and end of that sequence (see page 60). Then, rewind the tape to before the beginning of the portion that you wish to keep.
- 2 Load a video cassette into the recording VCR.
- 3 Press Δ on the camcorder to begin playback, then press the Record button on the VCR to begin recording.
- 4 Press the Pause/Still button on the VCR to pause recording when the source tape reaches the beginning of the sequence to be cut.
- 5 Press the Pause/Still (or Record) button on the VCR to resume recording when the source tape reaches the end of the sequence to be cut.

To stop editing

Press ∇ on the camcorder and press the Stop button on the VCR.

Notes:

- Some of the transitions between edited sequences may be slightly off.
- There may be picture noise during video search or still playback. This does not imply a defect in the camcorder.
- The time code display will be recorded along with the edited sequences if the TC OUT menu item is set to "ON". Set to "OFF" before editing (see page 60).

Advanced Features Playback

Recording from an External Source

Available mode:
Tape Playback

You can use this camcorder to record or edit videos from another source, such as a VCR or TV.

Preparation

Connect the camcorder to the source equipment with the supplied audio/video/S-video cable, as shown.

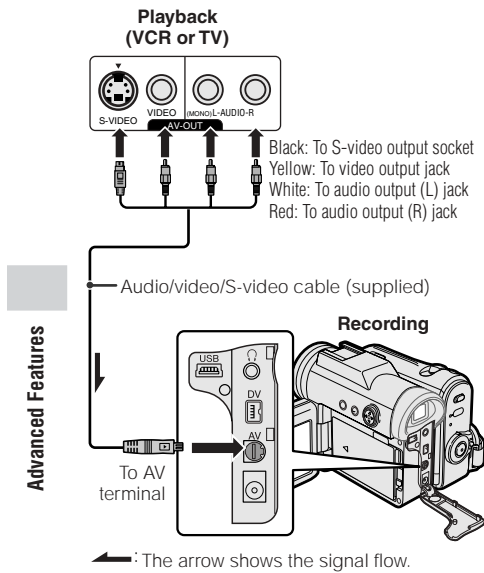

Notes:

- See page 2 for how to open the terminal cover.
- If the source equipment has only one audio output jack, use the white plug for the audio connection on the source equipment. (The input audio will only be recorded on the left channel of the tape.)
- Even if the source equipment has an S-video output socket, connect both the yellow video plug and S-video plug.

To Record from an External Source

- 1 In Tape Playback mode, press the DISPLAY button until the mode screen appears.
- 2 Select "MENU", then "EXECUTE" by using the Operation button (see page 32).
- 3 Press ∇ or Δ to select \square 2, then press the center of the Operation button.
- 4 Press ∇ or Δ to select "S-VIDEO IN", then press the center of the Operation button.

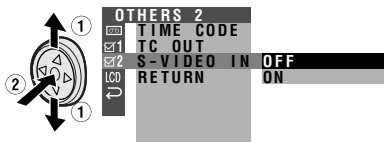

- 5 Press ∇ or Δ to select "ON" (for S-video connection) or "OFF" (for video connection), then press the center of the Operation button.
- 6 Press the DISPLAY button to turn off the menu screen.
 - "S-VIDEO" appears on the screen during a pause or Recording Standby mode when you set the S-VIDEO IN menu item to "ON" in step 5 above.
- 7 Begin playback on the source equipment connected to the camcorder.
 - Check the camcorder screen to see if the picture is properly received.
- 8 Press the Start/Stop button on the camcorder, then press Δ to begin recording.

Notes:

- To pause recording, press Δ . Press Δ again to resume recording.
- To operate by remote control, perform steps 1 to 7 above, and press the TAPE REC START/STOP button, then press the PAUSE/STILL button (g).
- If "NO SIGNAL" is displayed on the camcorder screen, check that the audio/video/S-video cable is properly connected.

Advanced Features Playback

Editing with the DV Terminal (IEEE1394)

Available mode:
Tape Playback

This camcorder can be used as a digital video editor. A DV cable transfers all dubbing signals including video and audio directly to the camcorder.

Preparation

Connect the camcorder to video equipment with a DV terminal using a commercially available DV cable.

To Record to Video Equipment

See "Cutting Unwanted Sequences" on page 61, using the video equipment as the recording source.

Note:

- Make sure that the video equipment to which you are recording can input dubbing signals via the DV terminal.

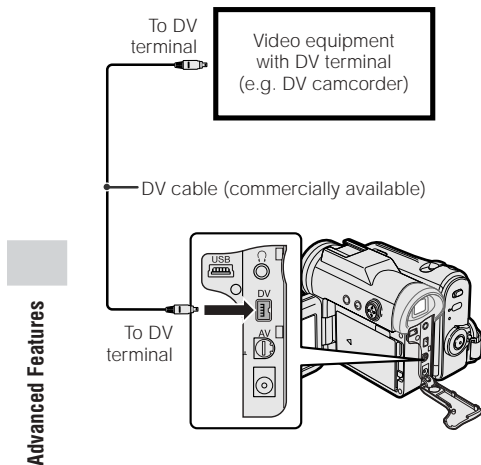

To Record from Video Equipment

- 1 Set the camcorder to Tape Playback mode, and insert a Mini DV cassette.
- 2 Begin playback on the video equipment connected to the camcorder.
 - Check the camcorder screen to see if the picture is properly received.
- 3 Press the Start/Stop button on the camcorder.
 - The camcorder enters Recording Standby mode.
- 4 Press Δ on the Operation button to begin recording.

To stop recording

Press ∇ on the Operation button.

Cutting Unwanted Sequences

- 1 Press Δ to pause recording when the source tape reaches the beginning of the sequence to be cut.
- 2 Press Δ to resume recording when the source tape reaches the end of the sequence to be cut.

Notes:

- Make sure that the video equipment from which you are recording can output dubbing signals via the DV terminal.
- If the video equipment is not set to playback mode or the DV cable is not properly connected, "NO SIGNAL" is displayed on the camcorder screen.
- If no picture or sound is input to the camcorder even if the DV cable is properly connected and you are playing back the source media from the video equipment, set the Power switch on the camcorder to OFF and then back to \blacktriangleright , or disconnect the DV cable and connect it again.
- If a digital video recording with a copyright protection signal is used as the playback source, "COPYRIGHT PROTECTED." appears on the camcorder monitor and the recording function is disabled (see page 96).
- When displaying the playback picture on the PC, you may find black bands around the image. This is caused by the differences of the image display sizes.
- "i.Link" refers to the IEEE1394-1995 industry specification and extensions thereof. The  logo is used for products compliant with the i.Link standard.

Advanced Features Playback

Using the Camcorder as a Converter

Available mode:
Tape Playback

You can use this camcorder to convert from analog signal (e.g. video recorded on 8 mm or Hi8 tapes) to digital signal.

Preparation

Connect the audio/video/S-video cable and DV cable as shown below.

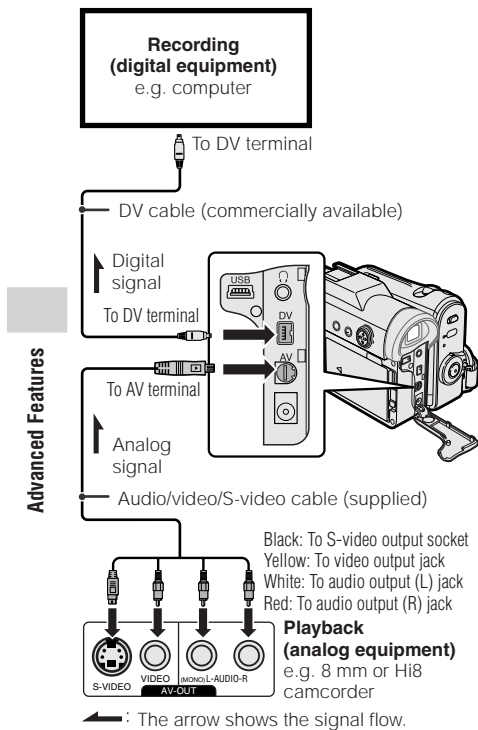

Note:

- See page 2 for how to open the terminal cover.

- 1 Set the camcorder to Tape Playback mode, and make sure that playback is stopped.
- 2 Press the DISPLAY button until the mode screen appears.
- 3 Select "MENU", then "EXECUTE" by using the Operation button (see page 32).
- 4 Press ∇ or Δ to select ∇ , then press the center of the Operation button.
- 5 Press ∇ or Δ to select "ANLG \rightarrow DGTL", then press the center of the Operation button.

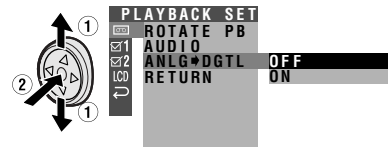

- 6 Press ∇ or Δ to select "ON", then press the center of the Operation button.

ANLG \rightarrow DGTL ON

7 Press the DISPLAY button to turn off the menu screen.

8 Press the Play button on the analog equipment

- Check the monitor on the digital equipment to see if the picture is being properly received.

9 Press the Record button on the digital equipment.

Notes:

- The camcorder is not guaranteed to work with all digital/analog equipment. Contact the manufacturer of your equipment for advice.
- If the camcorder outputs a video recording with a copyright signal, the digital equipment cannot record or save it.
- The camcorder may not convert some input video recordings properly (e.g. discoloration, picture noise, muted sound), depending on the input condition.

Advanced Features Playback

Audio Dubbing Feature

Available mode:
Tape Playback

You can add narration to recordings made with this camcorder, while preserving the original audio and video recordings.

Microphone for Audio Dubbing

You can use the built-in stereo microphone to record narration.

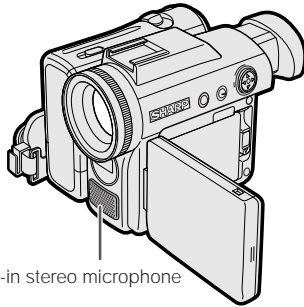

Built-in stereo microphone

Advanced Features

Notes:

- Audio dubbing does not function through the DV terminal.
- You cannot use audio dubbing with recordings made in LP mode.
- You cannot use the built-in stereo microphone for audio dubbing when the audio/video/S-video cable is connected.
- You cannot use the zoom microphone to record narration.

Audio Recording

In normal recording mode

12-bit audio recording

The audio is recorded in stereo on Audio 1.

Audio 1: Stereo (left and right) sound

Audio 2: No audio

16-bit audio recording

The audio is recorded in stereo with the left and right sound on two separate channels.

Audio 1: Left sound

Audio 2: Right sound

In Audio Dubbing mode

12-bit audio recording

The dubbed audio is recorded on Audio 2.

Audio 1: Original stereo (left and right) sound

Audio 2: Dubbed stereo (left and right) sound

16-bit audio recording

The dubbed audio is recorded on Audio 2 over the original right sound. Both dubbed and original sounds are mono.

Audio 1: Original left sound

Audio 2: Dubbed sound

Note:

- You can select the 12-bit or 16-bit audio recording mode by performing the procedure on page 46.

Audio Dubbing

- 1 Play back the Mini DV cassette recorded in SP mode and locate the tape position where you wish to start audio dubbing.
- 2 Press Δ on the Operation button to pause playback.
- 3 Press the DISPLAY button until the mode screen appears.
- 4 Press ∇ or Δ to select "AUDIO DUB", then press the center of the Operation button.



- 5 Press ∇ or Δ to select "EXECUTE", then press the center of the Operation button.
 - The audio dubbing screen appears.



- 6 Press Δ to begin audio dubbing. Record your narration.

To pause audio dubbing

Press ∇ . To resume audio dubbing, press Δ again.

To cancel audio dubbing

Press the center of the Operation button in step 5. The audio dubbing screen disappears.

If you wish to change the dubbed audio or dub additional scenes

- 1 Press the DISPLAY button to turn off the audio dubbing screen.
- 2 Repeat steps 1 to 6 above.

Notes:

- It is recommended that you use Audio Dubbing only with recordings made with this camcorder. Use of recordings made with other digital video equipment may result in poor audio quality.
- Audio dubbing will automatically pause if the original audio changes from 12-bit mode to 16-bit mode or vice versa. Press Δ to resume operation.
- Audio dubbing will automatically stop if a portion recorded in LP mode or an unrecorded portion of the tape is encountered.
- You can play back the dubbed audio and the original audio together or separately (see page 70).
- "AUDIO DUB" cannot be selected when the Mini DV cassette is recorded in LP mode.

Advanced Features Playback

Selecting the Audio Playback Mode

Available mode:
Tape Playback

You can select any of the following audio playback modes.

Audio 1H2

- 12-bit recording in stereo (Audio 1 and Audio 2 channels)
- 16-bit recording in stereo (left and right channels)

Audio 1

- 12-bit recording in stereo (Audio 1 channel only)
- 16-bit recording in mono (left channel only)

Audio 2

- 12-bit recording in stereo (Audio 2 channel only)
- 16-bit recording in mono (right channel only)

- 1 Playback a Mini DV cassette with dubbed audio.
- 2 Press the DISPLAY button until the mode screen appears.
- 3 Select "MENU", then "EXECUTE" by using the Operation button (see page 32).

- 4 Press ∇ or Δ to select ∇ , then press the center of the Operation button.
- 5 Press ∇ or Δ to select "AUDIO", then press the center of the Operation button.

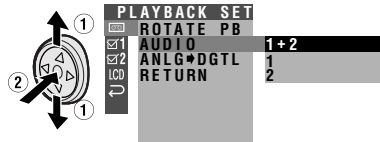

- 6 Press ∇ or Δ to select the desired audio playback mode, then press the center of the Operation button.

AUDIO 1+2

- 7 Press the DISPLAY button to turn off the menu screen.
 - The selected audio playback mode indicator only appears when the on-screen indicators are turned on.



Audio playback mode indicator

Note:

- The audio playback mode indicator, "AUDIO", displays in different colors depending on the recording mode (12- or 16-bit) used for the recording being played back. A white display indicates 12-bit recording mode, while a green indicates 16-bit.

Digital Still Camera Features

Camera Recording

Selecting the Picture Quality and Image Size

Available mode:
Card Camera

The picture quality of still images recorded on the card depends on the picture quality and image size setting. Select the appropriate setting to match your recording objectives.

Approximate number of recordable images with the supplied 8 MB SD memory card

Picture quality setting	Approx. number of images	
	1280 G 960	640 G 480
NORMAL	20	90
ECONOMY	40	160
FINE	10	50

Note:



- The number of recordable images differs depending on the combination of picture quality settings used and the images shot.

Selecting the Picture Quality

The camcorder compresses each image with the picture quality setting to save memory on a card.

Types

- NORMAL:** Records images with standard picture quality.
- ECONOMY:** Allows you to take more shots than in NORMAL mode but with lower quality.
- FINE:** Records images with higher quality than in NORMAL mode but with lower number of recordable images.

- Set the Media Selection switch to , then hold down the Lock button and set the Power switch to .

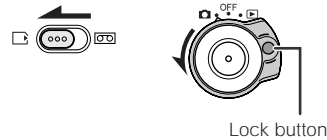

- In Card Camera mode, press the DISPLAY button until the mode screen appears.



- Select "MENU", then "EXECUTE" by using the Operation button (see page 32).

- Press ∇ or Δ to select Y, then press the center of the Operation button.

- Press ∇ or Δ to select "REC MODE", then press the center of the Operation button.

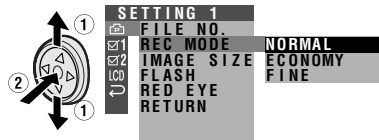

- Press ∇ or Δ to select the desired setting, then press the center of the Operation button.



(Continued on the next page) 71

Digital Still Camera Features Camera Recording

- Press the DISPLAY button to turn off the menu screen.
 - The selected picture quality indicator only appears when the on-screen indicators are turned on.



Note:

- The picture quality indicator is also displayed in Card Camera mode. The picture quality indicator displayed during playback is based on the amount of data for that recorded image. Since the amount of data differs depending on factors such as image detail, sometimes the picture quality indicator displayed during playback may not match the picture quality setting used during recording.

Selecting the Image Size

Still images recorded on a card are made up of pixels. You can select the number of pixels in still images. Larger numbers of pixels provide greater image detail, but also use more card memory.

Types

1280G960 (1280): Images are recorded in 1280K 960 pixels.

640G480 (640): Images are recorded in 640K 480 pixels.

- In Card Camera mode, press the DISPLAY button until the mode screen appears.
- Select "MENU", then "EXECUTE" by using the Operation button (see page 32).

- Press ∇ or Δ to select Y, then press the center of the Operation button.

- Press ∇ or Δ to select "IMAGE SIZE", then press the center of the Operation button.

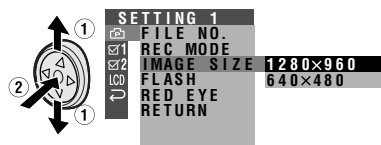

- Press ∇ or Δ to select "1280G960" or "640G480", then press the center of the Operation button.

IMAGE SIZE 1280x960

- Press the DISPLAY button to turn off the menu screen.

- The selected image size indicator appears when the on-screen indicators are turned on.



Card Recording

Available mode:
Card Camera

You can take a still picture in the same way as you do with a standard camera and record that image on the card.

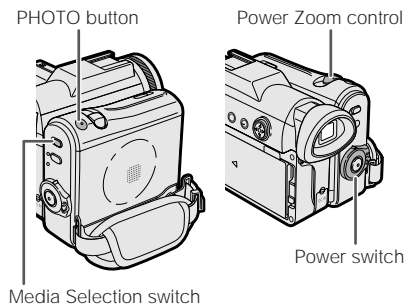

- 1 Insert a card into the camcorder (see page 11).
- 2 Remove the lens cap.
- 3 Set the Media Selection switch to
- 4 Hold down the Lock button and set the Power switch to

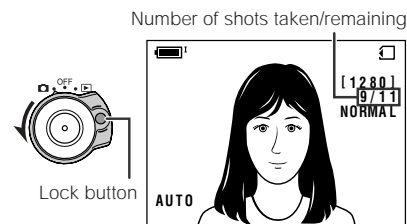

- 5 Adjust the Power Zoom control to frame the subject as you desire.
- 6 Press the PHOTO button half-way down to focus on the subject.
 - The camcorder automatically focuses on the subject. When it is set, you will hear a sound and see T mark, then the camcorder locks the focus.



- 7 Press the PHOTO button fully to begin recording.

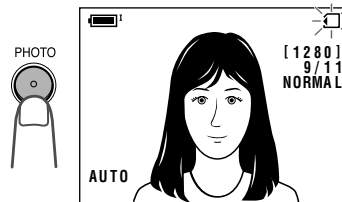

- The S indicator flashes red while data is being recorded on the card, and returns to white when recording completes.
- To record another image, release the PHOTO button and make sure the picture is not frozen in the monitor, then perform steps 6 and 7.

Notes:

- Recording under insufficient lighting may result in blurred images. It is recommended that you use a tripod to record insufficiently illuminated subjects.
- Recording under the light of a fluorescent, mercury, or sodium lamp may cause flickering in the image and, depending on the timing of the shot, may result in changes to color hue in the image.
- Set the BEEP menu item to "OFF" to turn off the focus locking sound.
- **Do not turn the power off or remove the card while the S indicator is flashing in step 7.**

Digital Still Camera Features

Selecting Flash Mode

Available mode:
Card Camera

Using the flash function allows you to record good-quality photos even in dark locations.

Note:

- The effective flash range is both wide angle and telephoto is 3 feet (1 to 2.5 m).

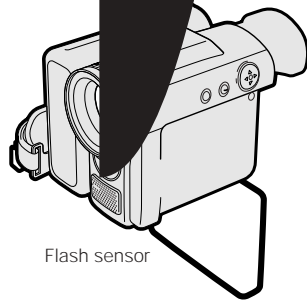

Types

AUTO: Flash automatically fires in dark locations (when "LIGHT" is displayed on the screen) each time you press the PHOTO button. The indicator appears when on-screen indicators are turned on.

ON: Flash fires every time you press the PHOTO button. The indicator appears when on-screen indicators are turned on.

OFF: Flash does not fire.

- In Card Camera mode, press the DISPLAY button until the mode screen appears.
- Select "MENU", then "EXECUTE" by using the Operation button (see page 32).
- Press ∇ or Δ to select Y, then press the center of the Operation button.
- Press ∇ or Δ to select "FLASH", then press the center of the Operation button.

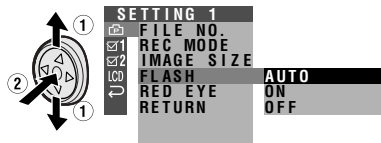

- Press ∇ or Δ to select the desired flash mode, then press the center of the Operation button.

FLASH ON

- Press the DISPLAY button to turn off the menu screen.
 - The flash indicator appears when on-screen indicators are turned on.

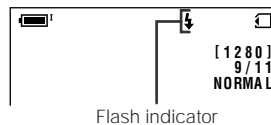

Notes:

- Do not use the flash in front of a person's eyes, especially children, as flashing directly into the eyes from close range can damage vision. Be particularly careful around children and maintain a distance of **3 feet (1 m) or more from your subject.**
- Do not block the flash sensor with fingers when using the flash.
- The indicator flashes while the flash is being charged.

Red-eye Reduction

Available mode:

Card Camera

Red-eye reduction allows you to minimize the camera flash capturing the red at the back of the iris.

- 1 In Card Camera mode, press the DISPLAY button until the mode screen appears.
- 2 Select "MENU", then "EXECUTE" by using the Operation button (see page 32).
- 3 Press ∇ or Δ to select Y, then press the center of the Operation button.
- 4 Make sure the flash mode is set to "AUTO" or "ON". If not, set to either one (see page 74).
- 5 Press ∇ or Δ to select "RED EYE", then press the center of the Operation button.

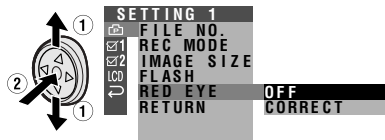

- 6 Press ∇ or Δ to select "CORRECT", then press the center of the Operation button.

RED EYE CORRECT

- 7 Press the DISPLAY button to turn off the menu screen.

- Red-eye indicator appears when on-screen indicators are turned on.

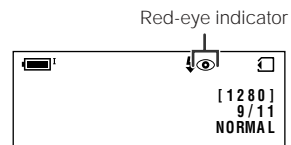

Notes:

- The flash fires twice when the red-eye reduction is set to "CORRECT". The first flash is to reduce the "red-eye", and the second flash is for recording the still image.
- The effect of red-eye reduction depends on individual. Reduction may not be as effective as desired on conditions like shooting distance or the subject not watching the pre-flash.
- Red-eye cannot be used when the flash is set to "OFF".

Digital Still Camera Features Camera Recording

Recording with the Self-timer

Available mode:
Card Camera

The self-timer function allows you to record images after a time-lag of 10 seconds. This is convenient when you want to record an image of you and your friends together.

- 1 In Card Camera mode, press the DISPLAY button until the mode screen appears.
- 2 Press ∇ or Δ on the Operation button to select "SELF TIMER", then press the center of the Operation button.



- 3 Press ∇ or Δ to select "EXECUTE", then press the center of the Operation button.

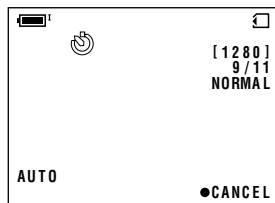

- 4 Press the PHOTO button to start the self-timer.
 - The self-timer operating indicator flashes while the timer counts down.

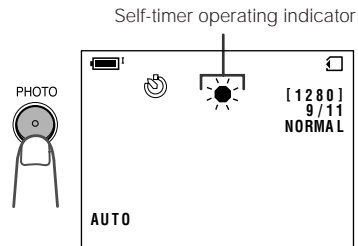

- The shutter automatically releases after 10 seconds, and a still image of the subject is recorded.

To cancel the countdown

Press the PHOTO button in step 4.

To cancel the self-timer

Press the center of the Operation button again in step 3.

Notes:

- When recording with the self-timer, stabilize the camcorder in the horizontal plane by attaching it to a tripod, etc.
- Self-timer mode cancels after recording one image. Repeat steps 1 to 4 to record another image with the self-timer.
- Do not turn the power off or remove the card once the self-timer operating indicator begins flashing.

Formatting a Card

Available mode:

Card Camera

Before using a commercially available card with this camcorder, you must first have it formatted. Also, if any of the following warning indicators displays, you will need to format your card.

- "FORMAT MEMORY CARD"
- "MEMORY CARD ERROR"
- "MEMORY CARD READ ERROR"
- "CANNOT STORE DATA"

Notes:

- Formatting a card erases all stored images, including delete-protected images. Be sure to backup important data on your computer or other media before formatting the card (see pages 86–88).
- Do not remove the power source during formatting, as this may cause damage to the camcorder or card. It is recommended that you use the AC outlet for the power supply.

- 1 In Card Camera mode, press the DISPLAY button until the mode screen appears.
- 2 Select "MENU", then "EXECUTE" by using the Operation button (see page 32).
- 3 Press ∇ or Δ to select \square 2, then press the center of the Operation button.

- 4 Press ∇ or Δ to select "FORMAT", then press the center of the Operation button.

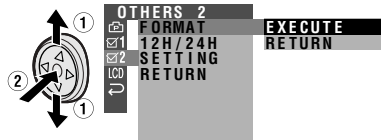

- 5 Press ∇ or Δ to select "EXECUTE", then press the center of the Operation button.

- To cancel formatting, press ∇ or Δ to select "RETURN", then press the center of the Operation button.

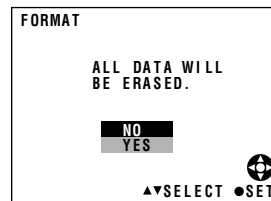

- 6 Press ∇ or Δ to select "YES", then press the center of the Operation button to begin formatting.
 - The menu screen displays when formatting finishes.
- 7 Press the DISPLAY button to turn off the menu screen.

Notes:

- The supplied card is preformatted for immediate use.
- **Use this camcorder to format a card. The camcorder may not recognize the images on a card formatted by a computer or other equipment.**

Digital Still Camera Features Camera Recording

Setting the File Numbering Method

Available mode:
Card Camera

The camcorder automatically assigns file numbers to captured images. You can select two different methods of file numbering.

Types

SERIAL: Defines file numbers by incrementing up from the last image captured when inserting a new card.

RESET: Defines a new set of file numbers when inserting a new card.

- 1 In Card Camera mode, press the DISPLAY button until the mode screen appears.
- 2 Select "MENU", then "EXECUTE" by using the Operation button (see page 32).
- 3 Press ∇ or Δ to select Y, then press the center of the Operation button.
- 4 Press ∇ or Δ to select "FILE NO.", then press the center of the Operation button.

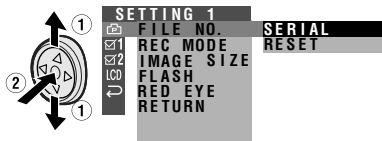

- 5 Press ∇ or Δ to select "SERIAL" or "RESET", then press the center of the Operation button.

FILE NO. SERIAL

- 6 Press the DISPLAY button to turn off the menu screen.

Note:

- When a warning indicator "MAXIMUM FILE NUMBER" appears on the screen, set FILE NO. menu item to "RESET", then format the card (see page 77) or replace the card with a new one (see page 11).

Digital Still Camera Features Playback

Playback Zoom

Available mode:
Card Playback

The playback zoom function allows you to magnify the playback picture up to 10 times its original size and shift the magnified picture by using the remote control. (See page 47 for use of the remote control.)

Note:

- Playback Zoom does not work in Tape Playback mode.

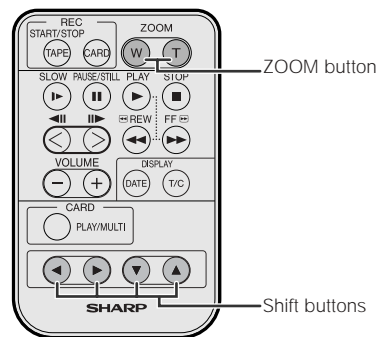

- 1 During Card Playback, press the ZOOM T button to zoom in.

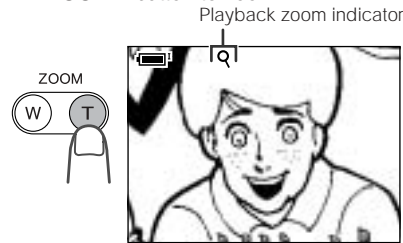

- 2 Press the Shift q, w, a, or s button to shift the displayed image.

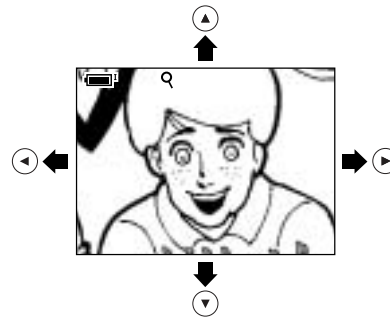

To cancel Playback Zoom

Press the ZOOM W button, which zooms out to the widest angle.

Note:

- Use of Playback Zoom may cause a reduction in picture quality for still images.

Delete Protection

Available mode:
Card Playback

You can prevent your important images recorded on the card from accidental erasure.

- In Card Playback mode, press the DISPLAY button until the mode screen appears.
- Press ∇ or Δ on the Operation button to select "PROTECT", then press the center of the Operation button.



- Press ∇ or Δ to select "EXECUTE", then press the center of the Operation button.
 - The PROTECT indicator appears.



PROTECT indicator

- Press \triangleleft , \triangleright , ∇ or Δ to select the image for delete protection.

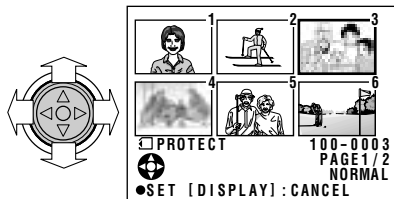

- Press the center of the Operation button to set delete protection.

- The R indicator appears.

Delete protection indicator

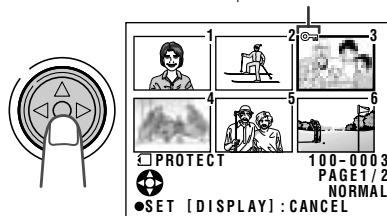

- If you want to protect another image, repeat steps 4 to 5.

- Press the DISPLAY button to finish the setting.

To cancel the protection setting

- Select the image for delete protection cancellation in step 4 above.
- Press the center of the Operation button to cancel the protection.
 - The R indicator disappears.

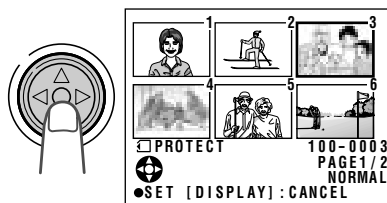

- Press the DISPLAY button to finish the setting.

Note:

- Formatting a card erases all stored images, including delete-protected images.

Digital Still Cam
Playback

Del

Deleting All Stored Images

You can delete all stored images on a card in one operation.

Notes:

- Deleted images cannot be restored. Check whether or not you want the images before performing the procedure below.
- If you want to keep some images on the card, first delete-protect them (see page 81), and then perform the procedure below.

- In Card Playback mode, press the DISPLAY button until the mode screen appears.
- Press ∇ or Δ on the Operation button to select "DELETE ALL", then press the center of the Operation button.



- Press ∇ or Δ to select "EXECUTE", then press the center of the Operation button.
 - The DELETE ALL? indicator appears.

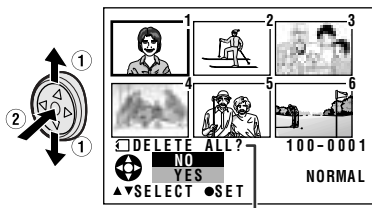

DELETE ALL? indicator

- Press ∇ or Δ to select "YES", then press the center of the Operation button.
 - To cancel the setting, select "NO".
- Press the DISPLAY button to finish the setting.

Notes:

- The protected images cannot be deleted. Cancel the protection setting to delete the image (see page 81).
- If a print order is assigned to delete-protected images and you perform the procedure above, the print order will cancel (the protection setting will not cancel).
- It may take several seconds to delete all images from the card.
- Do not turn the power off while deleting images.

at "PRI."
the center of
appears.



to select the
ent to assign a

Operati
ct

ts

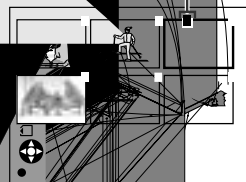

print

on
nish

Digital Still Camera Features Playback

Transferring Data on Card to Computer

Using the supplied USB cable, you can transfer still images to a computer.

System Requirements

- Operating systems
 - Microsoft Windowsb XP Home Edition/Professional
 - Microsoft Windowsb 2000 Professional
 - Microsoft Windowsb Me
 - Microsoft Windowsb 98 Second Edition
 - Microsoft Windowsb 98
- USB terminal
- CD-ROM drive (for driver installation)
- Mouse or other pointing device

Note:

- The USB driver is not compatible with Macintosh operating systems.

Installing the USB Driver

For installing the USB driver in Windowsb XP or Windowsb 2000, you need to log in as the system administrator.

- 1 Turn on the PC.**
 - Do not connect the camcorder to the PC with the USB cable at this point.
- 2 Insert the supplied CD-ROM containing the USB driver into the CD-ROM drive.**
 - The Setup screen will display automatically.



- The example screen shown is for Windowsb XP.

Note:

- When the Setup screen does not appear,
 - 1 select "Run..." in Windowsb "Start" menu, then
 - 2 type "R:\SETUP.EXE", and then click on the "OK" button.
- In the example above the CD-ROM drive letter is taken as "R:". Select the correct drive letter according to your operating environment.



-
- 3** Click the “USB driver” button.
 - Welcome screen appears.
 - 4** Click the “Next” button.
 - Information screen appears
 - 5** Click the “Next” button.
 - Installation begins.
 - 6** Confirm the message on the screen, and then click the “Finish” button to complete the installation.

Note:

- If your computer gives you the option to restart, you may do so.

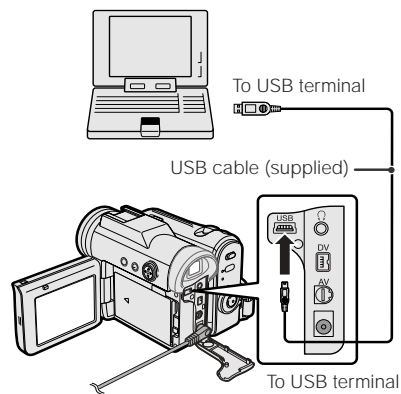
- 7** Insert a card that contains recorded still images into camcorder.
- 8** Connect the camcorder to the PC with the supplied USB cable as shown below.
 - It is recommended to use the AC adapter as a power source for extended periods of use.



- 9** Set the Media Selection switch to .
- 10** Hold down the Lock button and set the Power switch to .

 - PC will recognize the camcorder automatically.

Digital Still Camera Features Playback

Image Folders and File Names

Double-click the My Computer icon on the PC and find a new drive called "Removable Disk (F:)" (or other drive letter, depending on your PC configuration). Still images recorded using the camcorder are stored in files and on a card as shown below.

 **DCIM** Folder of still image files

 **100SHARP** Sub-folder of still images

Serial number
(100 to 999)

 Still image

Note:

- If you copy any data incompatible with this camcorder to the card, the camcorder will not be able to recognize it.

Caution on transferring data

While transferring data, the transfer indicator moves. Do not execute the operations below.

- Disconnecting the USB cable
- Switching the power on/off
- Turning off the PC or setting it to Standby
- Removing the card

Transfer indicator

Note:

- In case of data transfer error, disconnect the USB cable, then connect it again, or set the Power switch to OFF, then set it to  again.

Slide Show Playback

Available mode:
Card Playback

You can automatically play back consecutive still images recorded on a card at intervals of 5 seconds. This is useful when confirming the data recorded on a card.

- 1 Set the camcorder to Card Playback mode.
- 2 Press \triangleleft , \triangleright , ∇ or \triangle on the Operation button to select the image from which you want to begin slide show playback.

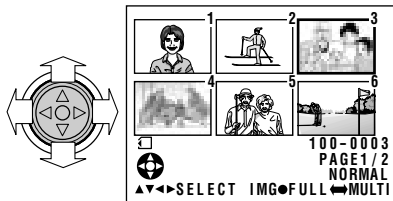

- 3 Press the DISPLAY button until the mode screen appears.
- 4 Press ∇ or \triangle to select "MENU", then press the center of the Operation button.
- 5 Press ∇ or \triangle to select "EXECUTE", then press the center of the Operation button.

- 6 Press ∇ or \triangle to select S, then press the center of the Operation button.
- 7 Press ∇ or \triangle to select "SLIDE SHOW", then press the center of the Operation button.

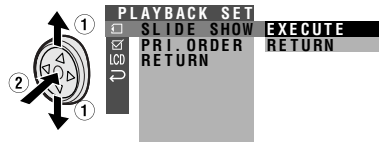

- 8 Press ∇ or \triangle to select "EXECUTE", then press the center of the Operation button.
 - Beginning from the image selected in step 2, the recorded images will display in full-screen one after another in order of recording.



- After playing back all the images on the card once, slide show playback automatically stops.
- 9 Press the DISPLAY button to turn off the menu screen.

To stop slide show playback

During slide show playback, press the center of the Operation button.

Appendix

Picture/Backlight Adjustments

Available modes:
All modes

If the picture is difficult to see due to ambient light or other factors, adjust the monitor picture settings.

- The example screens shown are for Tape Camera mode.

Adjusting the Picture

- 1 Press the DISPLAY button until the mode screen appears.
- 2 Press ∇ or Δ on the Operation button to select "MENU", then press the center of the Operation button.
- 3 Press ∇ or Δ to select "EXECUTE", then press the center of the Operation button.
- 4 Press ∇ or Δ to select \bigcirc , then press the center of the Operation button.



- 5 Press ∇ or Δ to select "LCD BRIGHT", "LCD COLOR" or "VF BRIGHT", then press the center of the Operation button.

- 6 Press \triangleleft or \triangleright to adjust the item to the desired setting, then press the center of the Operation button.

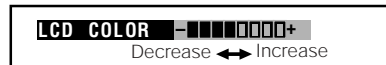

- 7 Press the DISPLAY button to turn off the menu screen.

Notes:

- When adjusting the color, the picture on the LCD monitor may differ from the picture actually recorded. Do not change the color setting unless necessary. (This adjustment only affects the monitor picture, not the

Adjusting the Backlight

- 1 Press the DISPLAY button until the mode screen appears.
- 2 Press ∇ or Δ on the Operation button to select "MENU", then press the center of the Operation button.
- 3 Press ∇ or Δ to select "EXECUTE", then press the center of the Operation button.
- 4 Press ∇ or Δ to select \bigcirc , then press the center of the Operation button.
- 5 Press ∇ or Δ to select "BACK-LIGHT", then press the center of the Operation button.



- 6 Press ∇ or Δ to select "NORMAL" or "BRIGHT", then press the center of the Operation button.

BACK LIGHT BRIGHT

NORMAL: For use indoors or under moderate lighting conditions.
BRIGHT: For use outdoors under strong lighting conditions, such as bright daylight.

- 7 Press the DISPLAY button to turn off the menu screen.

Turning off the Confirmation Sound

Available modes:

All modes

A confirmation sound is made when you turn on or off the Power switch, press the Start/Stop button, or perform other designated operations. Use the procedure below to turn off the confirmation sounds.

- The example screens shown are for Tape Camera mode.

- 1 Press the DISPLAY button until the mode screen appears.
- 2 Press ∇ or Δ on the Operation button to select "MENU", then press the center of the Operation button.
- 3 Press ∇ or Δ to select "EXECUTE", then press the center of the Operation button.
- 4 Press ∇ or Δ to select \boxtimes 1, then press the center of the Operation button.
- 5 Press ∇ or Δ to select "BEEP", then press the center of the Operation button.

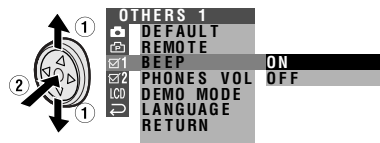

- 6 Press ∇ or Δ to select "OFF", then press the center of the Operation button.

BEEP OFF

- 7 Press the DISPLAY button to turn off the menu screen.

Note:

- If you select "OFF", the focus confirmation sound in Card Camera mode will turn off.

Appendix

Selecting the Language for the Information Display

Available modes:

Tape Camera, Card Camera

This camcorder allows you to choose English, French or Spanish as the information display language.

Information display

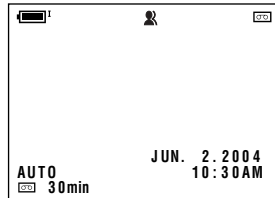

• The example screens shown are for Tape Camera mode.

- 1 Press the DISPLAY button until the mode screen appears.
- 2 Press ∇ or Δ on the Operation button to select "MENU", then press the center of the Operation button.
- 3 Press ∇ or Δ to select "EXECUTE", then press the center of the Operation button.
- 4 Press ∇ or Δ to select 1, then press the center of the Operation button.
- 5 Press ∇ or Δ to select "LANGUAGE", then press the center of the Operation button.

Appendix

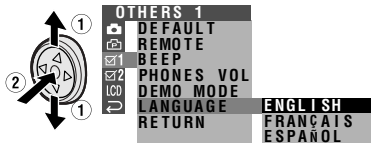

- 6 Press ∇ or Δ to select the desired language, then press the center of the Operation button.

LANGUE FRANÇAIS

- 7 Press the DISPLAY button to turn off the menu screen.
 - The information display appears in the language selected when the on-screen display turns on.

Appendix

Demonstration Mode

Available modes:

Tape Camera, Card Camera

You can watch a brief demonstration of the special camcorder features in Demo mode. If the demonstration appears on the screen when you turn on the camcorder for the first time, cancel the Demo mode to use your camcorder.

Watching

- The example screens shown are for Tape Camera mode.

- 1 Remove the Mini DV cassette from the camcorder (see page 10).
- 2 In Tape Camera or Card Camera mode, press the DISPLAY button until the mode screen appears.
- 3 Press ∇ or Δ on the Operation button to select "MENU", then press the center of the Operation button.
- 4 Press ∇ or Δ to select "EXECUTE", then press the center of the Operation button.
- 5 Press ∇ or Δ to select \square 1, then press the center of the Operation button.
- 6 Press ∇ or Δ to select "DEMO MODE", then press the center of the Operation button.

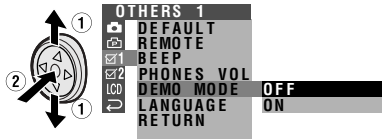

- 7 Press ∇ or Δ to select "ON", then press the center of the Operation button.

DEMO MODE ON

- 8 Set the Power switch to OFF, then hold down the Lock button and set the Power switch to \square .
 - The demonstration begins.

Canceling

- 1 During the demonstration, press the center of the Operation button to pause the demonstration.
- 2 Perform step 3 to 6 in "Watching", then select "OFF" in step 7.

Notes:

- The demonstration will pause if you press the center of the Operation button. If you leave it for 60 seconds, or turn the power off temporarily and then set the Power switch to \square , the demonstration will begin again.
- Demonstration mode does not work in self recording with reversed grip.

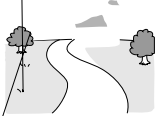
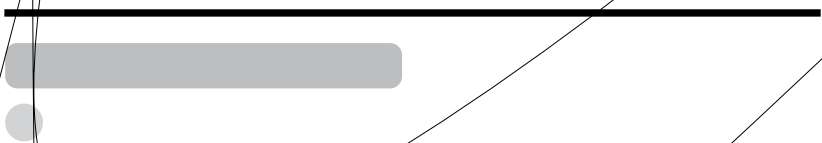

Position the subject in the center.

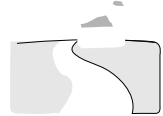

Focus manually when you need to position the subject off center (see page 53).



Appendix

Mini DV Cassette

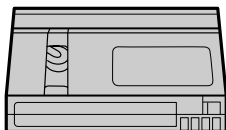

Precautions when using a Mini DV cassette

- Be sure to use only Mini DV cassettes with the **i** mark.
- This camcorder can record and play back using Mini DV cassettes with cassette memory, but it cannot record or play back this memory.
- To record in LP mode, use a Mini DV cassette labeled for use with LP mode.
- Do not insert anything into the holes on the bottom of the Mini DV cassette or block them in any way.
- Avoid placing the Mini DV cassette in areas conducive to dust or mold.
- Do not place the Mini DV cassette near magnetic sources such as electric clocks or magnetic devices as this may adversely affect recorded material.
- When a previously recorded Mini DV cassette is used again for recording, the previously recorded material will be automatically erased.
- The Mini DV cassette will not operate if inserted in the wrong direction.
- Do not repeatedly insert and eject the Mini DV cassette without running the tape as this may cause uneven tape winding and damage the tape.
- Do not place the Mini DV cassette in direct sunlight, near strong heat sources, or in areas with excessive steam.
- Store the Mini DV cassette in its case and stand it in an upright position.
- If the tape is not properly wound, rewind the tape.
- Do not drop the Mini DV cassette or subject it to excessive shocks.

To protect recordings against accidental erasure

Slide the protect tab on the rear of the Mini DV cassette to the "SAVE" position.



To record over a previously recorded tape, slide the protect tab to the "REC" position.

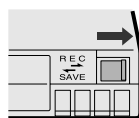

Copyright Protection

The digital VCR has far superior recording and playback ability than the traditional analog VCR, and in order to protect digital video software copyrights, a system for managing copyrights has been established. Some digital video recording with pre-recorded copyright protection signals can still be played back on this camcorder. If you play a digital video recording that has a copyright protection signal on video equipment with a DV terminal and attempt to record a copy of that software on this camcorder, "COPYRIGHT PROTECTED." appears on the screen and the recording is disabled.

This product incorporates copyright protection technology that is protected by method claims of certain U.S. patents and other intellectual property rights owned by Macrovision Corporation and other rights owners. Use of this copyright protection technology must be authorized by Macrovision Corporation, and is intended for home and other limited viewing uses only unless otherwise authorized by Macrovision Corporation. Reverse engineering or disassembly is prohibited.

SD™ Memory Card and MultiMediaCard™

SD (Secure Digital) Memory Cards and MultiMediaCards are small, handy and flexible storage media used in a variety of mobile applications. They are one of the smallest memory solutions available on the market. This camcorder uses either an SD Memory Card or a MultiMediaCard. It cannot use a SmartMedia™ card or Memory Stick®.

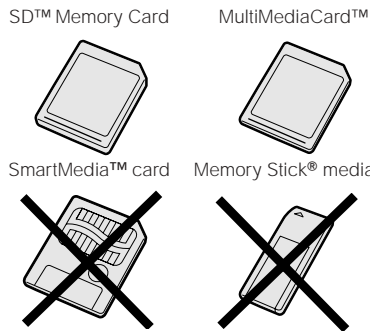

- An SD Memory Card has more advanced features than a MultiMediaCard, including cryptographic security for copyrighted data and a selectable mechanical write-protect switch.
- The card slot on this camcorder is compatible with an SD Memory Card or MultiMediaCard.
- An SD Memory Card and a MultiMediaCard are cross-compatible. Data stored on one can be easily transferred to the other.

Note:

- This camcorder is verified to work properly with the following card memory types.
 - SD Memory Card: 128 MB or less
 - MultiMediaCard: 64 MB or less

Removable Storage Care

Below are some precautions to ensure a long life and perfect performance from your SD Memory Card (SDMC) or MultiMediaCard (MMC). Information specific to one card is attached with the card's acronym (either SDMC or MMC).

Precautions

- Be sure to insert the card in the correct direction. Do not try to force the card in.
- Store the card in its antistatic plastic case when not in use.
- Do not disassemble or modify the card.
- Do not strike, bend or drop the card.
- Do not allow the card to become wet.
- Do not peel off the card label.
- Do not attach other labels or stickers to the card.
- Do not expose to extreme heat sources (e.g. sunlight, heating appliances).
- Do not store in a highly humid or dusty place.
- Do not store in a place exposed to corrosive gas.
- Do not use in a place exposed to strong electromagnetism.

Protecting your images

- Select the write-protect switch on the exterior card casing to protect your images. (SDMC)
- Do not power off any devices while transferring data, as this may destroy the data.
- Back up your image data often to a hard disk or other permanent storage media.
- Be aware that formatting will erase all image data stored on the card.

Note:

- **Sharp Corporation cannot be held liable for data that is lost through improper handling of the storage media.**

Cleaning

- Be careful not to allow dirt and finger grime buildup around the card contacts.
- Be careful about static electricity, which can suddenly erase data.
- If you notice dirt or static electricity, clean the card with a soft, dry cloth.

Condensation

- Be careful about condensation forming on the card surface, which can cause malfunction.
- If you notice beads of water on the card, allow it to evaporate and dry naturally.

Appendix

Battery Pack

This camcorder uses a lithium-ion type battery pack.

Charging

- Charge the battery pack immediately (or a day) before use. The battery pack gradually self-discharges even if stored in a fully charged state.
- Charge the battery pack between 50°F and 86°F (10°C and 30°C).
- Fully charge the battery pack. Use of an insufficiently charged battery pack will shorten actual time of use.
- Refresh (discharging before charging) is unnecessary.

Use

- To conserve battery power, be sure to turn off the camcorder power when not in use.
- Battery consumption may vary depending on the condition of use. Recording with many starts and stops, frequent zooming, and recording in low temperatures will shorten actual recording times.
- Use of a weak battery pack may cause loss of power while operating the camcorder. Use a fully charged battery pack to protect both the battery pack and the unit.
- It is recommended that you have enough battery packs on hand to handle two or three times your estimated recording time. See page 22 for the approximate times of actual recording for the battery packs.

Battery power is consumed even when the camcorder power is turned off. If you are not going to use your camcorder immediately, remove the battery pack (see page 7).

Note:

- Use only SHARP BT-L226 battery packs. These are designed specifically for use with this camcorder.

Storage

- Store the battery pack in a fully discharged state.
- Store the battery pack in a dry, cool place.
- When storing the battery pack, put it in the original protective plastic bag.

Notes:

- Improper handling of the battery pack may present a risk of fire or explosion. Pay close attention to the following:
 - Do not allow metallic objects to come in contact with the terminals. This can cause a short circuit.
 - Do not disassemble or repair the battery pack by yourself.
 - Do not use any battery charging equipment other than that designed for use with these battery packs.
 - Do not place the battery pack under direct sunlight or in excessively hot places (over 140°F or 60°C) such as the dashboard of cars.
 - Do not expose the battery pack to moisture or water.
 - Do not drop the battery pack or subject it to strong force.
 - Keep the battery pack out of reach of children.
 - Dispose of used battery packs promptly. Do not dispose of them in fire.
- To protect the terminals, put the cover on the battery pack when it is not in use.
- The battery pack will become warm during charging and use. This is not a malfunction.
- The battery pack has a limited service life. If the period of use becomes noticeably shorter with a normal charge, the battery pack is at the end of its service life. Replace it with a new battery pack.
- If the terminals of the battery pack are dirty, wipe the terminals with a soft, dry cloth.

Extending battery pack life

Even when the battery pack is not used, the capacity of the battery pack will naturally deteriorate over time. To limit the deterioration of the capacity, it is recommended to perform the following procedure at least once every six months:

- 1 Charge the battery pack until the POWER/CHARGE (RED) indicator turns off.
- 2 Attach the battery pack to the camcorder, and set the Power switch to  without inserting a cassette. Allow the battery power to fully discharge by leaving it on the camcorder until the camcorder power automatically turns off.
- 3 Remove the battery pack and store it between 50°F and 68°F (10°C and 20°C).

AC Adapter

- The AC adapter may interfere with reception if used near a radio.
- Prevent flammables, liquids, and metal objects from entering the adapter.
- The adapter is a sealed unit. Do not attempt to open or modify it.
- Do not damage, drop, or subject the adapter to vibration.
- Do not leave the adapter in direct sunlight.
- Avoid using the adapter in humid or extremely hot places.

Replacing the Fluorescent Lamp

This camcorder uses a fluorescent lamp to backlight the LCD monitor. If the monitor becomes dark or difficult to view, the fluorescent lamp may need to be replaced. Contact the nearest SHARP service center or your dealer for further advice.

Cleaning

- Many plastic parts are used in the camcorder casing. Do not use thinner, benzene or other strong chemical cleaners. These may cause discoloration and damage to the casing.
- Clean the casing with a soft, dry cloth. If the casing is particularly dirty, wipe the casing with a tightly wrung cloth dampened with a diluted, neutral detergent. Then wipe it again with a soft, dry cloth.
- Use a soft cloth to wipe finger marks and other smudges off the LCD screen.
- Use a soft cloth, or compressed air and lens paper designed for photographic lenses to clean the lens.
- Pull out the viewfinder and open the window cleaning cover as shown below so that you can clean up the inside of the viewfinder with a camera blower.

Window cleaning cover

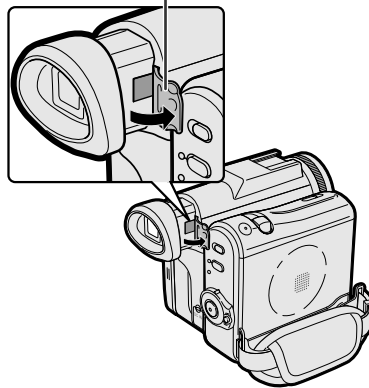

Appendix

Using Your Camcorder Abroad

Television signal standards and electrical voltages and frequencies vary substantially from country to country. When you are abroad, check the sections below before using the AC adapter or connecting the camcorder to a TV.

AC Adapter (Supplied Accessory)

The supplied AC adapter is compatible with 50 Hz and 60 Hz electrical systems in the range of 110 V to 240 V AC.

Use a commercially available AC plug adaptor, if necessary, depending on the design of the wall outlet.

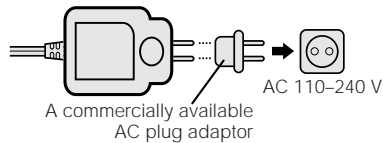

Television Signal Standards

In any country, you can always watch the video picture by using the LCD monitor screen. However, if you want to watch the picture on a TV screen, the TV must be NTSC-M system compatible. NTSC-M is used in the following areas:

The Bahamas, Barbados, Bermuda, Myanmar (previously Burma), Canada, Chile, Colombia, Costa Rica, Cuba, the Dominican Republic, Ecuador, El Salvador, Greenland, Guam, Guatemala, Haiti, Honduras, Jamaica, Japan, South Korea, Mexico, the Netherland Antilles, Nicaragua, Panama, Peru, the Philippines, Puerto Rico, St. Kitts, St. Lucia, Surinam, Taiwan, Trinidad, the U.S.A., Venezuela, Southern Vietnam, and the Virgin Islands.

Troubleshooting

Before calling for service, please check the following troubleshooting table.

	Symptom	Possible cause	Suggested solution
Power	No power.	Power source is not properly connected.	Connect power source properly (pp. 6, 9).
		Battery pack is not charged.	Charge battery pack sufficiently (p. 8).
		Dew in camcorder.	Wait until dew dries (p. xiii).
		Safety function is in effect.	Set Power switch to OFF and remove battery pack. Wait for 2 seconds, then reinstall battery pack and turn on power (pp. 6, 7).
Camera mode	Start/Stop button does not work.	Erase-protect tab on video cassette is open.	Close tab or use a new cassette (p. 96).
	Power suddenly turns off.	Camcorder left in Recording Standby mode for 5 minutes in Tape Camera mode.	Set Power switch to OFF and then back to Camera mode.
	Auto focus does not work.	Manual Focus mode is engaged.	Set to Auto Focus mode (p. 54).
		Zoom used on close subject.	Zoom out from subject (p. 23).
		Subject has little contrast in brightness, or is full of horizontal or vertical stripes.	Focus manually (p. 53).
	Bright subject produces wide vertical lines.	Occurs when shooting subject with strong contrast to the background. Does not indicate a malfunction.	—
Display automatically changes in Tape Camera mode.	Camcorder is in Demo mode.	Set the DEMO MODE menu item to "OFF" (p. 94).	

Appendix

	Symptom	Possible cause	Suggested solution
Playback mode	No image appears on connected TV screen.	Video input channel on TV or TV channel is not selected properly.	Select video input channel or TV channel properly (p. 30).
		Audio/video/S-video cable is not properly connected.	Connect audio/video/S-video cable properly (p. 30).
	No image from an external source appears on the camcorder screen.	DV cable or audio/video/S-video cable is not properly connected.	Connect DV cable or audio/video/S-video cable properly (pp. 61, 62, 66).
		The cable connection does not match the S-VIDEO IN menu setting.	Set the S-VIDEO IN menu item to "ON" for S-video connection, or "OFF" for video connection (p. 63).
	Cannot rewind or fast forward tape.	Position at beginning or end of tape.	Rewind or fast forward tape to desired point (p. 27).
		Using a cleaning tape	The cleaning tape will automatically rewind after cleaning finishes (p. xiv).
	Video noise in image.	Dirty video heads.	Call for service (p. 105) or use a commercially available cleaning tape (p. xiv).
		Old or worn tape.	Use a new cassette.
	No sound.	Using a 12-bit recording tape with AUDIO menu item set to "AUDIO 2".	Set the AUDIO menu item to "AUDIO 1" or "AUDIO 1L 2" (p. 70).
	Tape does not work.	Power switch is set to Camera mode.	Set the Power switch to Playback mode (p. 21).
		Media Selection switch is set to Card mode.	Set the Media Selection switch to Tape mode (p. 21).
		Battery pack is depleted.	Charge battery pack or replace it with a fully charged one (pp. 6–8).
Still images in Card mode are rotated 180° upside down.	The images are recorded in self-recording with reversed grip.	Transfer the data to PC (pp. 86–88), and rotate the images 180° back by using a commercially available editing software.	
Motion images are rotated 180° upside down.	Improper self recording.	Turn on Rotate Playback (p. 51).	

	Symptom	Possible cause	Suggested solution
Card mode	Cannot delete image on card.	Image is delete-protected.	Cancel the protection setting (p. 81).
	Cannot format card.	---	Contact your dealer for advise.
General	Battery pack is easily depleted.	Using camcorder in extremely cold environment.	Warm up battery pack, for example in your pocket, just before using it.
		Battery pack is not fully charged.	Charge battery pack sufficiently (p. 8).
	Clock has been re-set.	Lithium battery is not properly installed.	Install lithium battery properly (p. 12).
		Lithium battery is depleted.	Replace new lithium battery (p. 12).
	Cassette will not eject.	Power source is not properly connected.	Connect power source properly (pp. 6, 9).
		Battery pack is not charged.	Charge battery pack sufficiently (p. 8).
		Camcorder is recording.	Stop recording and try again (p. 22).
	No image on monitor.	Backlight has been turned off.	Turn on backlight (p. 24).
		Fluorescent lamp has burned out.	Call for service (p. 105).
	Viewfinder picture is hard to see.	Viewfinder diopter is not properly adjusted.	Adjust diopter (p. 18).
		Inappropriate picture adjustments.	Adjust picture (p. 90).
	Monitor picture is hard to see.	Inappropriate picture adjustments.	Adjust picture (p. 90).
POWER/CHARGE (RED) indicator flashes in red when charging battery pack.	AC adapter or battery pack may have malfunctioned.	Call for service (p. 105).	
Cannot edit to connected VCR.	Audio/video/S-video cable is not properly connected.	Connect audio/video/S-video cable properly (p. 61).	

Appendix

	Symptom	Possible cause	Suggested solution
General	Remote control does not function.	REMOTE menu item is set to "OFF".	Set REMOTE menu item to "ON" (p. 47).
		Remote control battery has run down.	Replace remote control battery with new one (p. 13).
		Remote control used beyond operating range.	Use remote control within operating range (p. 47).
		Intense daylight falling on camcorder remote sensor.	Protect remote sensor from exposure to intense daylight (p. 47).
		Obstacle between remote control and camcorder remote sensor.	Remove obstacle or use remote control from different angle (p. 47).
	"E007" is displayed on the screen, and unable to operate normally.	The camcorder may be damaged.	Do not take out a cassette, and call for service (p. 105).

Notes:

- This unit is equipped with a microprocessor. Its performance could be adversely affected by external electrical noise or interference. If this should happen, turn off the power and disconnect the unit from any power sources, including the lithium battery, etc. Then reconnect the power sources to resume operation.
- If the characters displayed in the viewfinder or on the LCD monitor screen appear to malfunction, disconnect the power source and remove the lithium battery, then reconnect the power source, insert the lithium battery, and turn the power on again. The characters on the monitor should be normal. Set the date and time, then resume operation.

Specifications

Camcorder

Signal System:	NTSC standard
Recording System:	2 rotary heads, helical scanning system
Cassette:	Digital VCR Mini DV video cassette
Recording/Playback Time:	90 minutes (DVM60, LP mode)
Tape Speed:	SP mode: 18.812 mm/second LP mode: 12.555 mm/second
Pickup Device:	$\frac{1}{4}$ " (6.4 mm, effective size: 4.5 mm) CCD image sensor (with approx. 1,330,000 pixels including optical black, effective pixels: 690,000 pixels in Tape Camera mode, 1,250,000 pixels in Card Camera mode)
Lens:	10K optical zoom lens (F1.8, f=3.8–38.0 mm)
Lens Filter Diameter:	30 mm
Monitor:	2.5" (6.4 cm) CGSilicon
Built-in microphone:	Electret stereo microphone
Color Temperature Compensation:	Auto white balance with white balance lock
Minimum Illumination:	3 lux (15 lux measured by EIA standard) (with gain-up, F1.8)
Still Image Compression System:	JPEG base line conformance
Still Image Recording Format:	JPEG (Exif2.2)
Still Image Recording Medium:	SD Memory Card, MultiMediaCard
Power Requirement:	DC 7.4 V
Power Consumption:	4.0 W (during camera recording in Tape Camera mode using the viewfinder in Full Auto mode with the DIS function on) 4.6 W (during camera recording in Tape Camera mode using the LCD monitor in Full Auto mode with the DIS function on and backlight in normal mode)
Operating Temperature:	32°F to 104°F (0°C to L 40°C)
Operating Humidity:	30% to 80%
Storage Temperature:	+ 4°F to 140°F (+ 20°C to L 60°C)
Dimensions (WK HK D) (approx.):	3 $\frac{1}{4}$ " K 3 $\frac{13}{32}$ " K 4 $\frac{1}{16}$ " (82.8 mm K 86.2 mm K 103.5 mm)
Weight (approx.):	1.12 lbs (510 g) (without battery pack, lithium battery, video cassette, lens cap and card)

AC Adapter (UADP-0339TAZZ)

Power Requirement:	AC 110–240 V, 50/60 Hz
DC Output:	10 V
Dimensions (WK HK D) (approx.):	1 $\frac{31}{32}$ " K 1 $\frac{1}{16}$ " K 2 $\frac{19}{32}$ " (50.0 mm K 27.0 mm K 65.5 mm)
Weight (approx.):	0.22 lbs (100 g)

Specifications are subject to change without notice.

SERVICE INFORMATION (For the U.S.)

For the location of the nearest Sharp Authorized Service, or to obtain product literature, accessories, supplies or customer assistance, please call 1-800-BE SHARP (1-800-237-4277) or visit SHARP's website (<http://www.sharppusa.com>).

On-screen Display Index

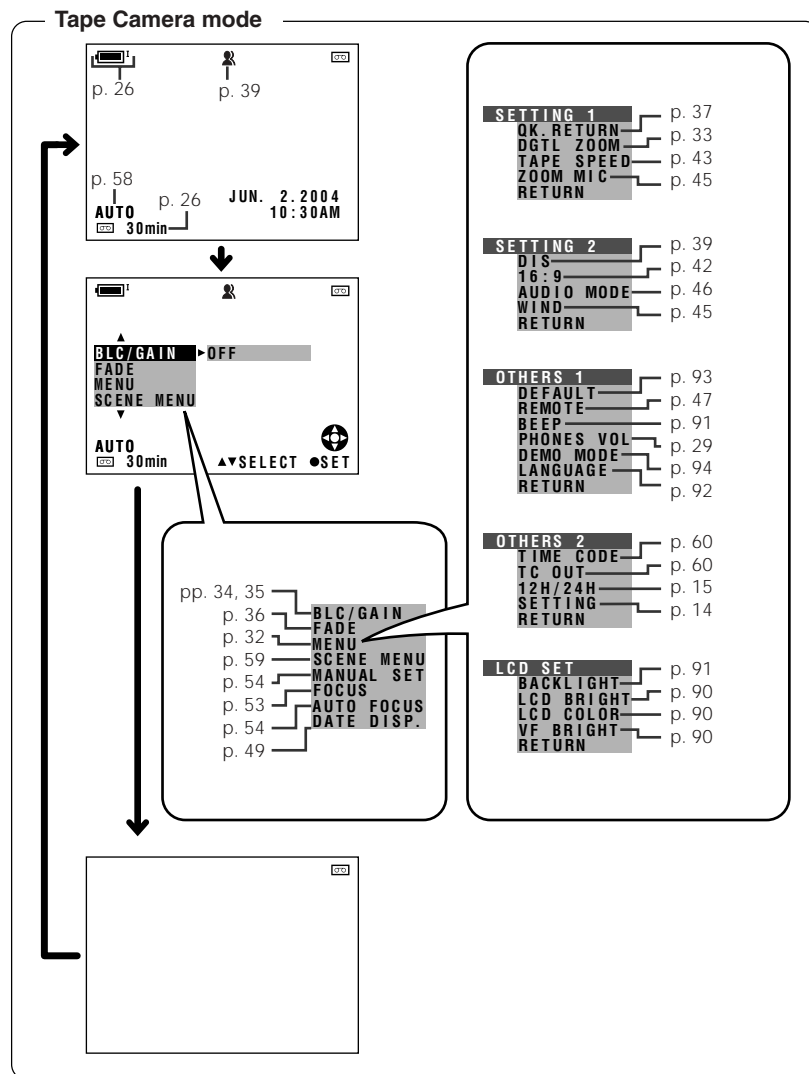

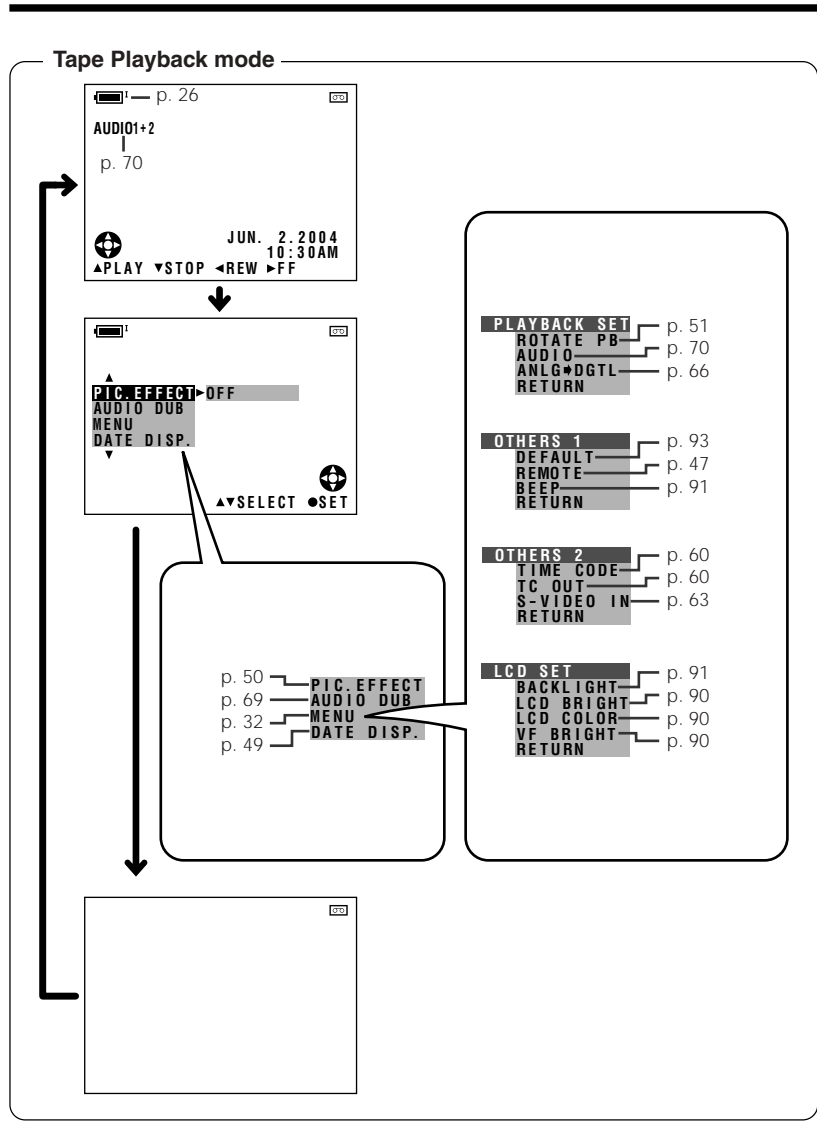

Appendix

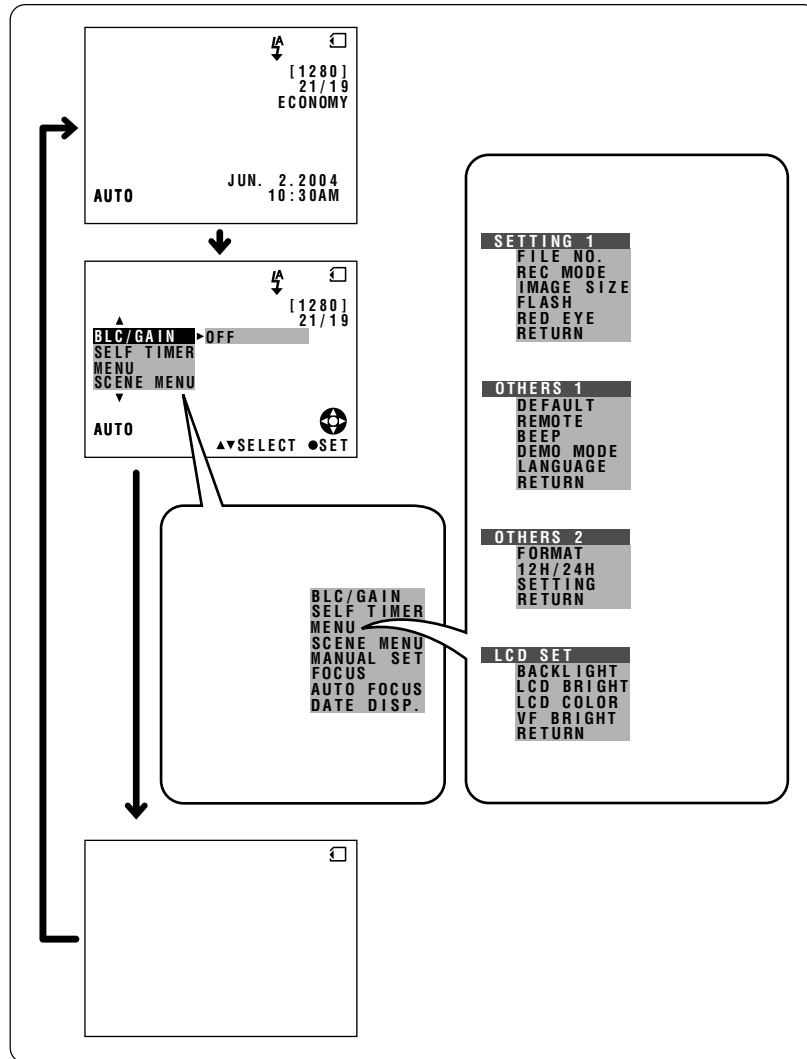

Appendix

Guía de operación rápida en español

Información importante para los consumidores de los EE.UU.

ADVERTENCIA: PARA REDUCIR EL RIESGO DE CAUSAR UN INCENDIO O RECIBIR UNA DESCARGA ELÉCTRICA, NO EXPONGA ESTE APARATO A LA LLUVIA NI A LA HUMEDAD.



PRECAUCION:
PARA REDUCIR EL RIESGO DE RECIBIR UNA DESCARGA ELÉCTRICA NO RETIRE LA TAPA. EN EL INTERIOR NO HAY PARTES QUE DEBA REPARAR EL USUARIO. SOLICITE LAS REPARACIONES AL PERSONAL DE SERVICIO CUALIFICADO.

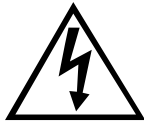

Este símbolo avisa al usuario de la presencia de tensión sin aislar en el interior del aparato que puede causar descargas eléctricas peligrosas.



Este símbolo alerta al usuario de que existen instrucciones de manejo y mantenimiento importantes en la información escrita entregada con este aparato.

PRECAUCION

PARA IMPEDIR DESCARGAS ELÉCTRICAS, INTRODUZCA LA PATILLA ANCHA EN LA RANURA ANCHA, E INTRODUZCA COMPLETAMENTE LA CLAVIJA. **(se aplica al adaptador de CA suministrado)**

PRECAUCION

Si el adaptador de CA se extravía o tiene que ser cambiado, adquiera otro del mismo tipo en el centro de servicio SHARP de su concesionario.

PARA TIRAR EL PRODUCTO

Este producto utiliza soldadura de estaño y plomo, y su lámpara fluorescente contiene una pequeña cantidad de mercurio. Debido a la conservación del medio ambiente, puede que para tirar estos materiales deban seguirse ciertos reglamentos. Para obtener información sobre cómo tirar o reciclar estos materiales, póngase en contacto con las autoridades de su localidad o con Electronics Industries Alliance (Alianza de Industrias de la Electrónica) en la dirección de Internet: www.eiae.org.

PARA TIRAR LA BATERÍA

CONTIENE BATERÍA DE IONES DE LITIO. ÉSTA DEBE RECICLARSE O TIRARSE DE LA FORMA APROPIADA. PÓNGASE EN CONTACTO CON LAS AGENCIAS LOCALES PERTINENTES PARA OBTENER INFORMACIÓN SOBRE LOS PLANES DE RECICLADO Y ELIMINACIÓN EXISTENTES EN SU ZONA DE RESIDENCIA.

Precauciones

- **Antes de grabar una escena importante, realice una prueba de grabación, y luego reproduzca para comprobar si la escena se grabó correctamente. Si se produce ruido, utilice una cinta de limpieza de venta en el comercio para limpiar las cabezas de vídeo (consulte la página xii).**

- **Cuando no utilice la videocámara, no se olvide de extraer el videocasete, desconectar la alimentación y desenchufar la videocámara de la fuente de alimentación.**

- **No dirija el objetivo hacia el sol.**
No permita que la luz del sol directa llegue al objetivo ni a la pantalla del monitor LCD de la videocámara, tanto si está realizando la grabación como si no, porque esto podría dañar el sensor de CCD o la superficie de la pantalla LCD. Tenga mucho cuidado especialmente cuando grabe en exteriores.

- **Evite los campos magnéticos.**
La utilización de la videocámara cerca de lámparas fluorescentes fuertes, motores, televisores u otros campos magnéticos puede afectar negativamente a las imágenes grabadas.

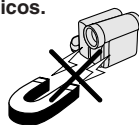

- **La utilización de la videocámara cerca de una emisora u otra fuente potente de transmisión puede causar zumbidos o deterioro en la imagen.**

- **Evite golpearla o dejarla caer.**
No deje caer la videocámara ni tampoco la someta a golpes o vibraciones intensas. Los golpes producidos durante la grabación ocasionarán ruidos en la imagen grabada.

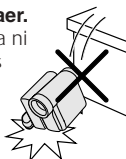

- **Evite poner la videocámara cerca de equipos de iluminación.**
El calor producido por las luces incandescentes puede deformar la videocámara o hacer que ésta funcione mal.

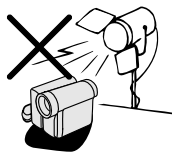

- **Respete siempre las prohibiciones o restricciones relacionadas con la utilización de equipos electrónicos en vuelos comerciales o en otras áreas susceptibles.**

- **Tenga cuidado con la temperatura y la humedad.**

Podrá utilizar su videocámara a temperaturas de entre 32°F y 104°F (0°C y L 40°C), con una humedad relativa de entre el 30% y el 80%. Durante el verano, no deje el aparato en el interior de un automóvil sin ventilación; no lo deje tampoco bajo la luz del sol directa ni cerca de fuentes de calor intenso; esto podría estropear considerablemente la caja del aparato y su circuito.



- **Evite situaciones en las que el agua, la arena, el polvo u otras sustancias extrañas puedan entrar en la videocámara, y no utilice ni deje su videocámara en lugares con excesivo humo, vapor o humedad.**

En estos ambientes pueden producirse fallos en el funcionamiento o se puede formar moho en el objetivo. Asegúrese de guardar este aparato en un lugar bien ventilado.

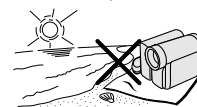

- **Algunos trípodes pequeños y portátiles quizá se acoplen mal a la videocámara, y puede que no sirvan de apoyo seguro. Utilice siempre trípodes fuertes y estables.**

- **Cuando utilice su videocámara en un ambiente frío, la pantalla del monitor LCD aparecerá a menudo menos brillante inmediatamente después de conectar la alimentación. Esto no es ningún fallo de funcionamiento. Para evitar que la videocámara se enfríe excesivamente, envuélvala en un paño grueso (una manta, etc.).**

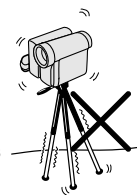

siguiendo las instrucciones del fabricante, y utilizando los accesorios de montaje recomendado por él.

9. La combinación del producto y un carrito deberá moverse con mucho cuidado. Las paradas

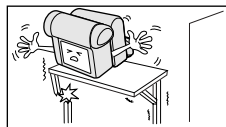
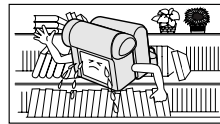

-
12. Puesta a tierra o polarización—Este producto puede estar equipado con una clavija de alimentación de corriente alterna polarizada (una clavija con una patilla más ancha que la otra). Esta clavija sólo entrará en la toma de corriente de una forma, lo que constituye una característica de seguridad. Si no puede introducir a fondo la clavija en la toma de corriente, pruebe invirtiendo la clavija. Si la clavija sigue sin poder introducirse en la toma de corriente, póngase en contacto con un electricista para que le cambie la toma de corriente obsoleta. No anule la característica de seguridad de la clavija polarizada.
13. Protección de cables de alimentación—Los cables de alimentación deberán instalarse de forma que nadie camine sobre ellos ni queden pellizcados por objetos colocados encima o contra ellos, poniendo mucha atención a las clavijas, receptáculos y al punto donde entran y salen del producto.
14. Tormentas eléctricas—Para que este producto disponga de una mayor protección durante una tormenta eléctrica, o para cuando se deje sin atender durante un largo periodo de tiempo, desenchúfelo de la toma de corriente y desconecte la antena o el sistema de cable. Esto impedirá que el producto se estropee debido a las tormentas eléctrica o a la sobretensión en la línea de alimentación.
15. Líneas de alimentación—Una antena exterior no deberá colocarse cerca de líneas de alimentación elevadas ni tampoco cerca de luces eléctricas o circuitos de alimentación, ni donde pueda caer encima de tales líneas de alimentación o circuitos. Cuando instale un sistema de antena exterior deberá tener mucho cuidado para que éste no toque tales líneas de alimentación o circuitos porque el contacto con ellos podría causar un accidente mortal.
16. Sobrecarga—No sobrecargue las tomas de corriente de la pared, los cables de extensión o los receptáculos integrales de otros equipos porque existe el riesgo de que se produzca un incendio o una descarga eléctrica.
17. Entrada de objetos y líquidos—No meta nunca objetos de ningún tipo en este producto a través de las aberturas porque pueden tocar puntos de tensión peligrosos o cortocircuitar partes que puedan causar un incendio o una descarga eléctrica. No derrame nunca líquidos de ningún tipo en el producto.
18. Servicio—No intente reparar este producto usted mismo ya que al abrirlo o retirar las cubiertas puede exponerse a una tensión peligrosa o a otros peligros. Solicite las reparaciones al personal de servicio cualificado.



-
19. Daños que requieren ser reparados—Desenchufe este producto de la toma de corriente y solicite las reparaciones al personal de servicio cualificado cuando se produzcan las condiciones siguientes:
- Cuando el cable de alimentación o su clavija estén estropeados.
 - Si se ha derramado líquido, o han entrado objetos, en el interior del producto.
 - Si el producto ha estado expuesto a la lluvia o al agua.
 - Si el producto no funciona normalmente siguiendo las instrucciones de manejo. Ajuste solamente los controles indicados en las instrucciones de manejo, ya que el ajuste incorrecto de otros controles puede causar daños y tal vez se requiera un trabajo de reparación extensivo por parte de un técnico cualificado para devolver el producto a su estado de funcionamiento normal.
 - Si el producto se ha caído o se ha estropeado de cualquier forma.
 - Cuando el producto muestre un cambio visible en su rendimiento,—esto indica la necesidad de tener que realizar reparaciones.
20. Partes de recambio—Cuando sea necesario utilizar partes de recambio, asegúrese de que el técnico de servicio emplee aquellas que hayan sido especificadas por el fabricante o que tengan las mismas características que las partes originales. Los cambios no autorizados pueden causar un incendio, descargas eléctricas u otros peligros.
21. Comprobación de seguridad—Al terminar cualquier trabajo de mantenimiento o reparación en este producto, pida al técnico de servicio que realice las comprobaciones de seguridad para determinar si el producto se encuentra en condiciones de funcionamiento apropiadas.
22. Montaje en la pared o en el techo—El producto deberá montarse en una pared o en un techo sólo como lo recomienda su fabricante
23. Calor—El producto deberá instalarse lejos de fuentes de calor tales como radiadores, salidas de calor, estufas y otros aparatos (incluyendo amplificadores) que produzcan calor.

Notas acerca de la utilización de la pila de litio

AVISO La pila utilizada en este aparato puede constituir un riesgo de incendio o quemadura química si no se maneja de la manera apropiada. No la cargue, desarme, caliente a más de 100°C ni incinere. Cambie la pila por una del tipo CR1216 en el caso de la videocámara y por una del tipo CR2025 en el caso del mando a distancia. Las pilas de recambio deberán haber sido fabricadas por la compañía Toshiba Battery Co., Ltd. El uso de otras pilas podría presentar un riesgo de incendio o explosión. Retire rápidamente la pila usada, y manténgala alejada de los niños. No desarme la pila ni la tire al fuego.

- No cortocircuite, cargue, desmonte o caliente la pila de litio.
- Si la pila de litio tuviera fugas retirela, limpie bien su compartimiento y luego introduzca una pila nueva.
- La pila de litio durará un año aproximadamente si se utiliza bajo condiciones normales.

Guía de operación rápida

Colocación de la batería

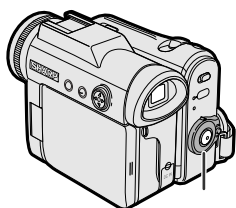

- 1 Asegúrese de que el interruptor de alimentación esté en OFF.



- 2 Abra el monitor LCD de manera que forme un ángulo de 90° con el cuerpo de la videocámara.

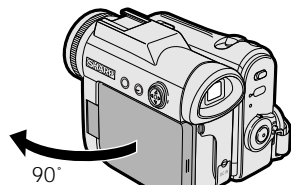

- 3 Deslice la batería en el sentido de la flecha con la marca "Δ" hacia fuera.



Inserción de un casete

- 1** Coloque la fuente de alimentación en la videocámara, y luego deslice y sujete el dispositivo de apertura de la puerta del videocompartimiento del casete según abre la puerta.

- Después del sonido de confirmación, el portavideocasete se extenderá y abrirá automáticamente.

Dispositivo de apertura de la puerta del compartimiento del casete

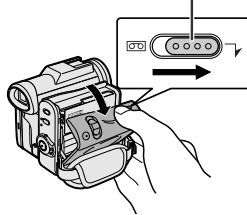

- 2** Inserte completamente un minivideocasete DV de venta en el comercio con la ventanilla hacia fuera, y con la lengüeta de protección contra borrado hacia arriba.

Lengüeta de protección contra borrado

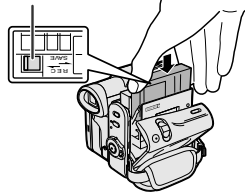

- 3** Pulse suavemente la marca "PUSH" hasta que el portavideocasete encaje en posición produciendo un chasquido.

- El portavideocasete se introducirá automáticamente.

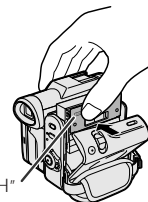

Marca "PUSH"

- 4** Espere a que el portavideocasete se pliegue completamente. Cierre la puerta del compartimiento presionando sobre el centro hasta que quede cerrada haciendo un ruido seco.

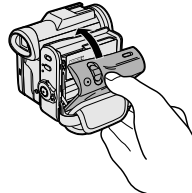

Extracción

Realice el paso 1 de arriba y luego saque el videocasete.

Guía de operación rápida

Inserción de una tarjeta

Para almacenar imágenes fijas podrá utilizar una tarjeta de memoria SD (suministrado) o una tarjeta MultiMediaCard (de venta en el comercio).

- 1 Asegúrese de que el interruptor de alimentación esté en OFF.
- 2 Abra la cubierta de la ranura de la tarjeta.

Cubierta de la ranura de tarjeta

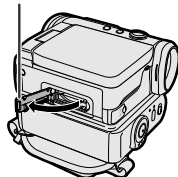

- 3 Inserte a fondo una tarjeta en la ranura como se muestra abajo.

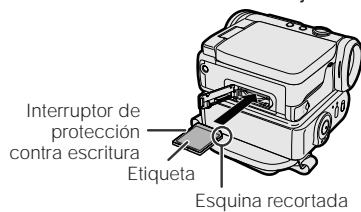

- 4 Cierre firmemente la cubierta de la ranura de la tarjeta.

Extracción

Realice los pasos 1 y 2 anteriores, empuje la tarjeta y retirela lentamente (1). Luego saque la tarjeta recta (2) como se muestra más abajo.

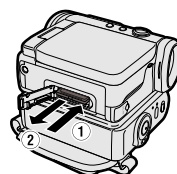

Nota:

- No puede utilizar una tarjeta SmartMediaE ni el medio Memory StickE. En este manual de manejo, "tarjeta" se refiere a la tarjeta de memoria SD o a la tarjeta MultiMediaCard.



Sugerencias sobre las posiciones de grabación

Para crear imágenes que puedan verse fácilmente durante la reproducción, intente grabar con una postura estable y apoyando bien la videocámara, para impedir la sacudida de las imágenes.

Sujeción de la videocámara

Pase su mando derecha a través de la correa para la mano, y ponga su mano izquierda debajo de la videocámara para apoyarla.

Postura básica

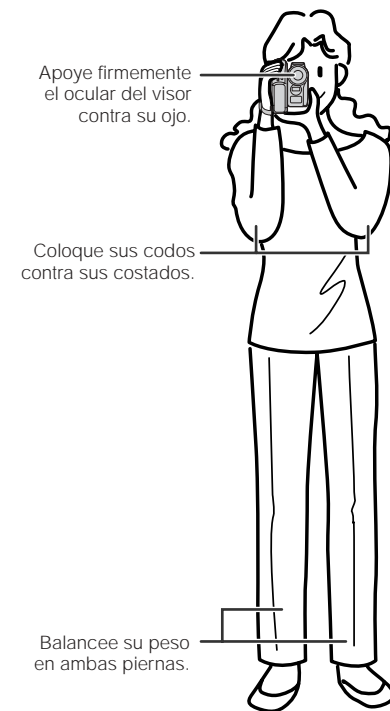

Filmación desde un ángulo alto



Filmación desde un ángulo bajo



Nota:

- Tenga cuidado para no tocar el micrófono con sus dedos durante la grabación. Esto causará ruidos en la pista de audio. Además, tenga cuidado de no tocar el flash ni el sensor del flash con sus dedos mientras graba con la tarjeta.



Guía de operación rápida

Grabación con tarjeta

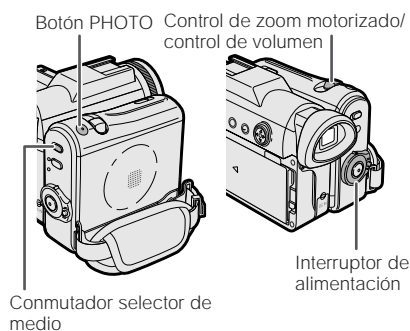

1 Inserte una tarjeta en la videocámara.

2 Ponga el conmutador selector de medio en .

3 Mantenga pulsado el botón de bloqueo y ponga el interruptor de alimentación en .

- La imagen captada por el objetivo se visualiza ahora.

Número de tomas realizadas/restantes

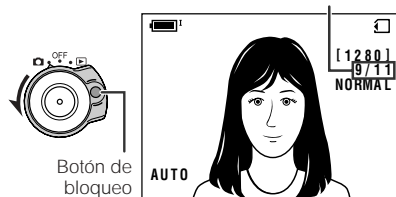

4 Ajuste el control del zoom motorizado para encuadrar el motivo como usted desee.

5 Pulse hasta la mitad el botón PHOTO para enfocar el motivo.

- La videocámara enfoca automáticamente el motivo. Cuando lo enfoque oírá un sonido y verá la marca . Luego, la videocámara bloqueará el enfoque.

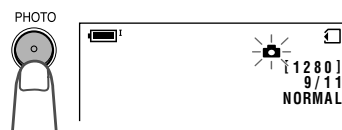

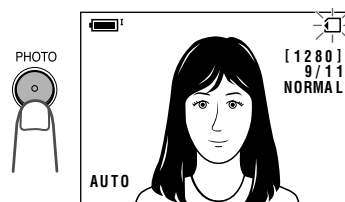

6 Pulse completamente el botón PHOTO para iniciar la grabación.





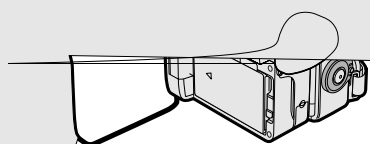

- El indicador S parpadea en rojo mientras los datos están siendo grabados en la tarjeta, y cambia a blanco cuando termina la grabación.

de
se visualiza



- 1** Ponga el conmutador selector de medio en .
- 2** Mantenga pulsado el botón de bloqueo y ponga el interruptor de alimentación en 
 - Las imágenes grabadas en la tarjeta se visualizan en el formato de imagen miniatura.

- 3** Pulse  ,  ,  o  del botón de operación para mover el cuadro de selección hasta la imagen deseada.

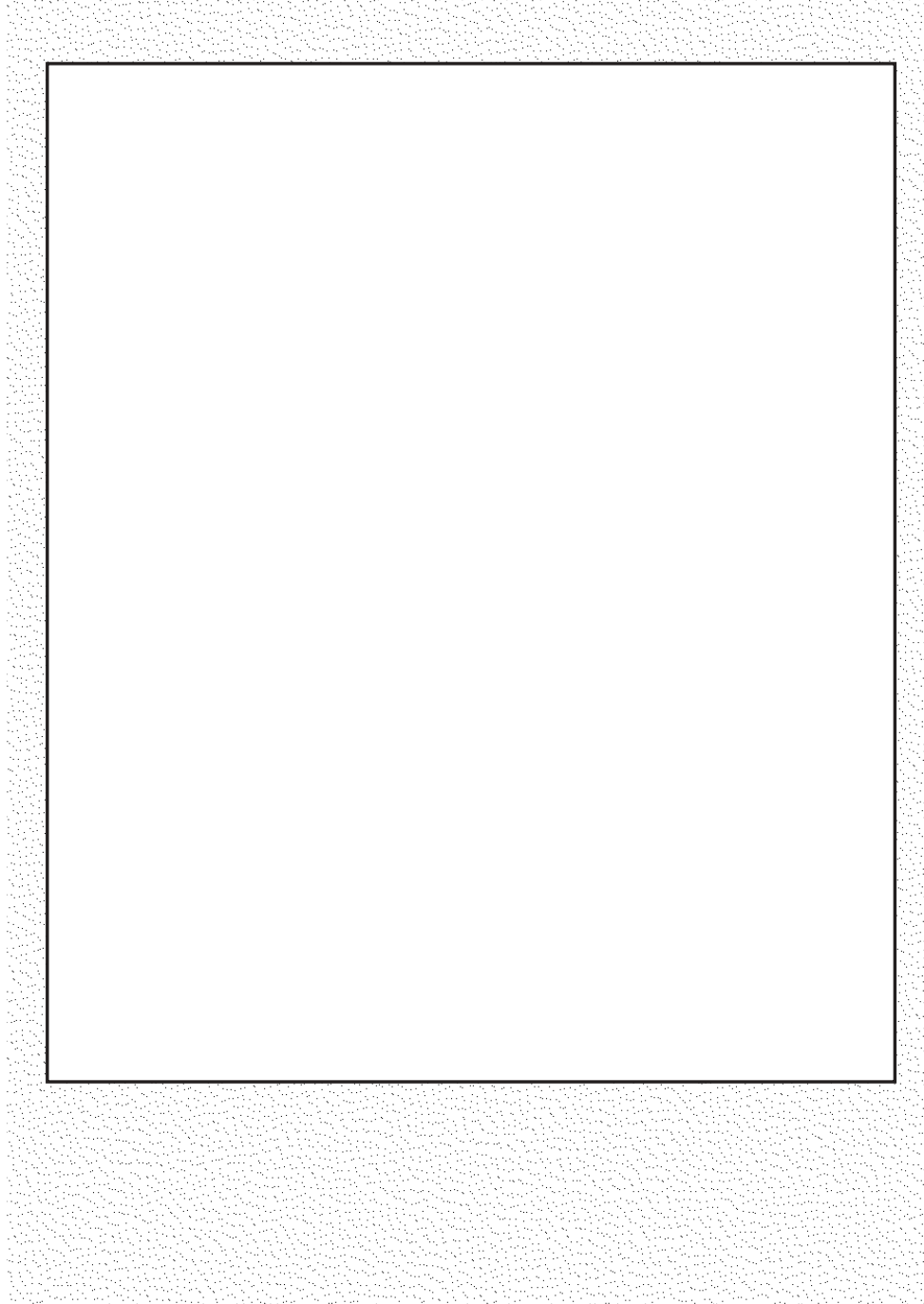

Free Manuals Download Website

<http://myh66.com>

<http://usermanuals.us>

<http://www.somanuals.com>

<http://www.4manuals.cc>

<http://www.manual-lib.com>

<http://www.404manual.com>

<http://www.luxmanual.com>

<http://aubethermostatmanual.com>

Golf course search by state

<http://golfingnear.com>

Email search by domain

<http://emailbydomain.com>

Auto manuals search

<http://auto.somanuals.com>

TV manuals search

<http://tv.somanuals.com>