

SHARP®

DVD RECORDER

MODEL

DV-SR3U

OPERATION MANUAL



SPATIALIZER®
N-2-2™



• The region number
for this recorder is 1



! IMPORTANT / IMPORTANTE

EZ SET UP (AUTO CHANNEL /CLOCK SET UP)

EZ SET UP (PROGRAMACIÓN AUTOMÁTICA DE CANAL/PUESTA EN HORA DEL RELOJ)

| | | | |
|---|--|---|--|
| <p>1 Connect Antenna/Cable to Recorder first. <i>En primer lugar conecte la antena/el cable a el producto.</i></p> | <p>2 Then, plug into AC Power Outlet. <i>A continuación, enchúfelos al tomacorriente de CA.</i></p> | <p>3 Do not press the POWER button until completion of EZ Set Up. <i>No pulse el botón de ALIMENTACIÓN (POWER) hasta haber terminado la EZ SET UP.</i></p> | <p>4 EZ SET UP complete. <i>EZ SET UP completo.</i></p> |
|---|--|---|--|

- Please read this Operation Manual carefully before using your Recorder.
- Instrucciones importantes de seguridad y guía de operación rápida en español
→Página 95

Detail: Please see page 25.
Detalle: véase la página 98.

For future reference, record the model and serial number (located on the rear of the product) in the space provided.

Model No.: DV-SR3U _____

Serial No.: _____

WARNING: TO REDUCE THE RISK OF FIRE OR ELECTRIC SHOCK, DO NOT EXPOSE THIS APPLIANCE TO RAIN OR MOISTURE.



CAUTION
RISK OF ELECTRIC SHOCK
DO NOT OPEN



CAUTION:
TO REDUCE THE RISK OF ELECTRIC SHOCK, DO NOT REMOVE COVER. NO USER-SERVICEABLE PARTS INSIDE. REFER SERVICING TO QUALIFIED SERVICE PERSONNEL.



This symbol warns the user of uninsulated voltage within the unit that can cause dangerous electric shocks.



This symbol alerts the user that there are important operating and maintenance instructions in the literature accompanying this unit.

“WARNING—FCC Regulations state that any unauthorized changes or modifications to this equipment not expressly approved by the manufacturer could void the user’s authority to operate this equipment.”

INFORMATION

This equipment has been tested and found to comply with the limits for a Class B digital device, pursuant to Part 15 of the FCC Rules. These limits are designed to provide reasonable protection against harmful interference in a residential installation. This equipment generates, uses and can radiate radio frequency energy and, if not installed and used in accordance with the instructions, may cause harmful interference to radio communications. However, there is no guarantee that interference will not occur in a particular installation. If this equipment does cause harmful interference to radio or television reception, which can be determined by turning the equipment off and on, the user is encouraged to try to correct the interference by one or more of the following measures:

- Reorient or relocate the receiving antenna.
- Increase the separation between the equipment and receiver.
- Connect the equipment into an outlet on a circuit different from that to which the receiver is connected.
- Consult the dealer or an experienced radio/TV technician for help.

CAUTION:

THIS UNIT IS A CLASS 1 LASER PRODUCT.

USE OF CONTROLS OR ADJUSTMENTS OR PERFORMANCE OF PROCEDURES OTHER THAN THOSE SPECIFIED HEREIN MAY RESULT IN HAZARDOUS RADIATION EXPOSURE.

AS THE LASER BEAM USED IN THIS UNIT IS HARMFUL TO THE EYES, DO NOT ATTEMPT TO DISASSEMBLE THE CABINET.
REFER SERVICING TO QUALIFIED PERSONNEL ONLY.

Note to CATV system installer:

This reminder is provided to call the CATV system installer’s attention to Article 820-40 of the National Electrical Code that provides guidelines for proper grounding and, in particular, specifies that the cable ground shall be connected to the grounding system of the building, as close to the point of cable entry as practical.

Products that have earned the ENERGY STAR® are designed to protect the environment through superior energy efficiency.

IMPORTANT SAFEGUARDS

CAUTION: Please read all of these instructions before you operate this product and save these instructions for later use.

Electrical energy can perform many useful functions. This product has been engineered and manufactured to assure your personal safety. BUT IMPROPER USE CAN RESULT IN POTENTIAL ELECTRICAL SHOCK OR FIRE HAZARDS. In order not to defeat the safeguards incorporated in this product, observe the following basic rules for its installation, use and servicing.

- 1. Read Instructions** – All the safety and operating instructions should be read before the product is operated.
- 2. Retain Instructions** – The safety and operating instructions should be retained for future reference.
- 3. Heed Warnings** – All warnings on the product and in the operating instructions should be adhered to.
- 4. Follow Instructions** – All operating and use instructions should be followed.
- 5. Cleaning** – Unplug this product from the wall outlet before cleaning. Do not use liquid cleaners or aerosol cleaners. Use a damp cloth for cleaning.
- 6. Attachments** – Do not use attachments not recommended by the product manufacturer as they may cause hazards.
- 7. Water and Moisture** – Do not use this product near water—for example, near a bath tub, wash bowl, kitchen sink, or laundry tub; in a wet basement; or near a swimming pool; and the like.
- 8. Accessories** – Do not place this product on an unstable cart, stand, tripod, bracket, or table. The product may fall, causing serious injury to a child or adult, and serious damage to the product. Use only with a cart, stand, tripod, bracket, or table recommended by the manufacturer, or sold with the product. Any mounting of the product should follow the manufacturer's instructions, and should use a mounting accessory recommended by the manufacturer.
- 9. Transportation** – A product and cart combination should be moved with care. Quick stops, excessive force, and uneven surfaces may cause the product and cart combination to overturn. 
- 10. Ventilation** – Slots and openings in the cabinet are provided for ventilation to ensure reliable operation of the product and to protect it from overheating, and these openings must not be blocked or covered. The openings should never be blocked by placing the product on a bed, sofa, rug, or other similar surface. This product should not be placed in a built-in installation such as a bookcase or rack unless proper ventilation is provided or the manufacturer's instructions have been adhered to.
- 11. Power Sources** – This product should be operated only from the type of power source indicated on the marking label. If you are not sure of the type of power supply to your home, consult your product dealer or local power company. For products intended to operate from battery power, or other sources, refer to the operating instructions.
- 12. Grounding or Polarization** – This product is equipped with either a two-wire polarized plug (one plug blade bigger than the other) or a three-wire grounded plug (a third pin for grounding). The two-wire polarized plug will fit only one way into the power outlet. The three-wire grounded plug will fit only into a grounding-type power outlet. If the plug does not fit, ask your electrician to replace your obsolete outlet. Do not modify the plug. To do so will void the safety feature.
- 13. Power-Cord Protection** – Power-supply cords should be routed so that they are not likely to be walked on or pinched by items placed upon or against them, paying particular attention to cords at plugs, convenience receptacles, and the point where they exit from the product.
- 14. Outdoor Antenna Grounding** – If an outside antenna or cable system is connected to the product, be sure the antenna or cable system is grounded so as to provide some protection against voltage surges and built-up static charges. Article 810 of the National Electrical Code, ANSI/NFPA 70, provides information with regard to proper grounding of the mast and supporting structure, grounding of the lead-in wire to an antenna discharge unit, size of grounding conductors, location of antenna-discharge unit, connection to grounding electrodes, and requirements for the grounding electrode. See diagram below.

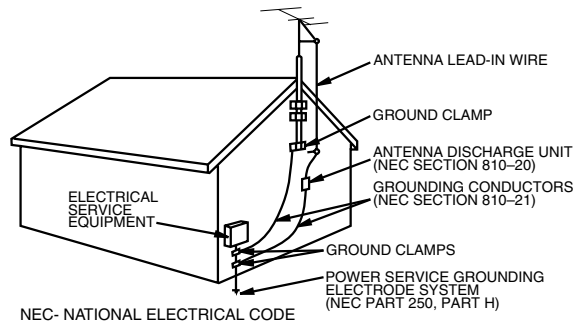

- 15. Lightning** – For added protection for this product during a lightning storm, or when it is left unattended and unused for long periods of time, unplug it from the wall outlet and disconnect the antenna or cable system. This will prevent damage to the product due to lightning and power-line surges.
- 16. Power Lines** – An outside antenna system should not be located in the vicinity of overhead power lines or other electric light or power circuits, or where it can fall into such power lines or circuits. When installing an outside antenna system, extreme care should be taken to keep from touching such power lines or circuits as contact with them might be fatal.
- 17. Overloading** – Do not overload wall outlets, extension cords, or integral convenience receptacles as this can result in a risk of fire or electric shock.
- 18. Object and Liquid Entry** – Never push objects of any kind into this product through openings as they may touch dangerous voltage points or short-out parts that could result in a fire or electric shock. Never spill liquid of any kind on the product.
- 19. Servicing** – Do not attempt to service this product yourself as opening or removing covers may expose you to dangerous voltage or other hazards. Refer all servicing to qualified service personnel.
- 20. Damage Requiring Service** – Unplug this product from the wall outlet and refer servicing to qualified service personnel under the following conditions:
 - When the power-supply cord or plug is damaged.
 - If liquid has been spilled, or objects have fallen into the product.
 - If the product has been exposed to rain or water.
 - If the product does not operate normally by following the operating instructions. Adjust only those controls that are covered by the operating instructions, as an improper adjustment of other controls may result in damage and will often require extensive work by a qualified technician to restore the product to normal operation.
 - If the product has been dropped or damaged in any way.
 - If the product exhibits a distinct change in performance, this indicates a need for service.
- 21. Replacement Parts** – When replacement parts are required, be sure the service technician has used replacement parts specified by the manufacturer or have the same characteristics as the original part. Unauthorized substitutions may result in fire, electric shock, or other hazards.
- 22. Safety Check** – Upon completion of any service or repairs to this product, ask the service technician to perform safety checks to determine that the product is in proper operating condition.
- 23. Heat** – This product should be situated away from heat sources such as radiators, heat registers, stoves, or other products (including amplifiers) that produce heat.

Contents

| | | | |
|---|-----------|--|-----------|
| IMPORTANT SAFEGUARDS | 3 | Clock Setting | 29 |
| Features | 6 | Auto Clock Setting | 29 |
| Accessories | 7 | Manual Clock Setting | 30 |
| Precautions about Using This Product | 8 | Automatic Daylight Saving-Time (DST) Adjustment | 30 |
| About DVD | 10 | Channel Setting | 31 |
| Types of Discs that Can Be Used with This Recorder ... | 10 | Channel Setting | 31 |
| Discs that Cannot Be Used with This Recorder | 10 | Adding/Erasing Channel Memory | 31 |
| Types of Discs for Recording | 11 | Display Information | 32 |
| Recording Formats | 12 | Content of TV Screen Display | 32 |
| Recording Time | 12 | Checking the Channel | 32 |
| Disc Remaining Time | 12 | Checking Remaining Time of DVD and Number of Titles | 32 |
| Using the Proper Disc | 13 | Switching Front Panel Display | 33 |
| Time Display for Recording and Playback (Video mode only) | 13 | Recording to DVD | 34 |
| Unrecordable Material | 13 | Loading Disc | 34 |
| Initialization and Finalization | 14 | Direct Recording to DVD | 34 |
| Initialization (Formatting) | 14 | Setting the Record End Time during Direct Recording (Simple Recording Timer) | 35 |
| Allowing Discs to Be Played Back with Other DVD Players (Finalization) | 14 | Setting Recording Mode | 36 |
| About the Contents of the Disc | 14 | DVD-RW/R Recording Mode and Recording Time | 36 |
| Title, Chapter and Track | 14 | Setting the Manual Recording Mode (MN) | 36 |
| Icons Used on DVD Video Disc Case | 15 | Timer Recording | 37 |
| The Icons Used in This Operation Manual | 15 | Easy Recording Guide | 37 |
| Important Information | 16 | Timer Recording with VCR Plus+® System | 39 |
| Disc Precautions | 16 | Timer Recording by Specifying Date, Time and Channel | 41 |
| Copyright | 16 | Confirm, Change and Cancel a Timer Program | 43 |
| Cautions Regarding Recording | 16 | Automatic Recording of Satellite Broadcast (AV AUTO REC) | 44 |
| Major Components | 17 | Connecting to a Satellite Receiver, etc. | 44 |
| Main Unit (Front) | 17 | Recording with AV AUTO REC | 44 |
| Front Panel Display | 17 | To Cancel the AV AUTO REC Function | 45 |
| Main Unit (Rear) | 17 | Eliminating Problems (Recording, Timer Recording) | 46 |
| Remote Control Unit | 18 | DVD/CD Playback | 47 |
| Loading the Batteries | 19 | Loading Disc | 47 |
| Operating a TV Using the Remote Control (Universal Remote Control) | 20 | Playback from REC LIST | 47 |
| Setting the Remote Control Code | 20 | DVD Video Playback | 48 |
| Basic Connection | 21 | Audio CD/Video CD Playback | 49 |
| Easy Connection | 21 | Other Types of Playback | 49 |
| Using Other Types of Video Output | 22 | Playback by Selecting with the Menu in the DVD | 53 |
| CATV or Satellite Receiver Connections | 23 | Setting a Clear Image and Powerful Sound | 54 |
| Connecting to a Cable Box or Satellite Receiver (1) | 23 | MP3 File Playback | 55 |
| Connecting to a Cable Box or Satellite Receiver (2) | 24 | To Play Another File (music title) during Playback | 55 |
| EZ Set Up | 25 | To Skip the File during Playback | 55 |
| Turning the Power On | 25 | Settings During Playback | 56 |
| Connection Guide | 26 | Function Control | 56 |
| Selecting the On-screen Display Language | 26 | Editing | 58 |
| Selecting the TV Terminal | 26 | About Editing | 58 |
| Selecting the TV Screen Aspect Ratio | 26 | Editing Procedure | 58 |
| Advanced Setting | 27 | Switching between Original and Play List (Play Lists can be created only for VR mode) | 59 |
| Completing the Initial Setting | 27 | | |
| About START MENU | 28 | | |
| About START MENU | 28 | | |
| Basic START MENU Operation | 28 | | |

| | |
|--|-----------|
| Editing an Original Title | 60 |
| Erasing Unnecessary Scenes from an Original Title (ERASE SCENE) | 60 |
| Inputting/Changing Title Name (CHANGE TITLE NAME) | 62 |
| How to Enter Text | 63 |
| Changing Thumbnail (CHANGE THUMBNAIL) | 64 |
| Making Sections in a Title (DIVIDE CHAPTER) | 65 |
| Combining Chapters Together (COMBINE CHAPTERS) | 66 |
| Disabling Title Edit and Erase (TITLE PROTECT) | 66 |
| Erasing All Titles | 67 |
| Erasing by Selecting a Title (or Chapter) | 67 |
| Editing a Play List | 68 |
| Creating a Play List | 68 |
| Adding a Scene from an Original to a Play List (ADD SCENE) | 69 |
| Changing the Title Sequence (MOVE TITLE) | 71 |
| Erasing Unnecessary Scenes (ERASE SCENE) | 72 |
| Inputting/Changing Title Name (CHANGE TITLE NAME) | 72 |
| Changing Thumbnail (CHANGE THUMBNAIL) | 72 |
| Making Sections in a Title (DIVIDE CHAPTER) | 72 |
| Combining Chapters Together (COMBINE CHAPTERS) | 72 |
| Enjoying High Quality Sounds | 73 |
| Playing 2 Channel Audio with an Analog Connection | 73 |
| Playing Dolby Digital (5.1 Channel) and DTS Audio with a Digital Connection | 73 |
| Playing 2 Channel Audio with a Digital Connection | 74 |
| Recording from External Equipment | 75 |
| Recording from a Camcorder (VCR) Using an Analog Connection | 75 |
| Function Setting | 76 |
| Basic Operation for REC FUNCTION Setting | 77 |
| Basic Operation for VIEW/PLAY SETTING | 79 |
| Basic Operation for ADJUSTMENT Setting | 83 |
| Initialization | 84 |
| Finalization | 84 |
| Basic Operation for INITIALIZE/FINALIZE | 85 |
| Troubleshooting | 86 |
| Service Information (For the U.S.) | 88 |
| On-screen Error Messages | 89 |
| Glossary | 91 |
| Specifications | 94 |

Features

1 A new timer recording system: “Easy Recording Guide”

- This feature makes timer recording easier. A schedule grid of times and channels is displayed on the screen, and by simply designating cells in the grid with the remote control, timer programming becomes as easy as circling your favorite shows in the newspaper. You can also see at a glance which time slots are already programmed, and avoid any overlap.

2 DVD-RW/R recording/playback with outstanding compatibility

- This Recorder is compatible with digital recording on rewritable DVD-RW discs and one-time recordable DVD-R discs. It has two recording formats: “VR (Video Recording) mode” which has a wealth of editing functions, and “Video mode” which can be played back with existing DVD players. This lets you enjoy recording to suit your purpose.

3 High picture quality design

① Progressive scanning playback

High-quality, high-density video with no jagged contours and no flicker.

② VBR (Variable Bit Rate) recording

Constantly maintains optimal high picture quality by varying the bit rate (amount of video data) for each scene depending on the video content (e.g. whether movement is fast or slow).

4 Comprehensive editing functions

(Only titles recorded in VR mode on DVD-RW can be edited.)

① Play list edit

This lets you gather only the needed parts (i.e. a “Play List”) from a recorded original video (title). You can rearrange scenes and combine them with other scenes, or rearrange titles.

② Chapter edit

This lets you divide a title into chapter units during recording/playback or using the edit screen. After dividing, a list of recordings (thumbnails) can be displayed in chapter units, so you can copy and erase to the play list in chapter units.

③ Erase scene

This lets you erase unnecessary scenes. This is convenient when you want to cut out the commercials in a recorded program.

④ Batch erasing of titles/chapters

Titles and chapters which become unnecessary after editing can be batch erased by selecting them from the list of recordings (thumbnails).

⑤ Edit undo function*4

If you mistakenly erase data during editing, this function lets you restore it to its immediately preceding state, just like “Undo” on a PC, so you can edit worry-free.

*4 Edit undo can only be used once. It only works when “UNDO” is assigned to a colored button (green) displayed on the screen.

5 Simple operation and user-friendly design using a new remote control

① START MENU

Press **START MENU** button on the remote control, and display the list of main functions on the screen. After that, you can operate by using the **Cursor** buttons and **SET/ENTER** button on the remote control, so this Recorder can be used easily even by a person who is unfamiliar with operation.

② Colored buttons

The remote control has colored buttons with four different colors. Functions are displayed in four different colors on the screen, and the Recorder can be operated by directly designating these functions.

③ Luminous buttons

Luminous buttons are used for key control buttons on the remote control so they are easy to see in the dark.

6 MP3 file playback

- This Recorder allows you to playback MP3 files recorded on CD-RW/R.

7 VCR Plus+*5 System

- The VCR Plus+ System allows you to program your Recorder for timer recording simply by inputting the PlusCode Programming number. The PlusCode numbers are listed in most newspapers, television guides, and local CATV listings. Simply by inputting this PlusCode number, you can program your Recorder for timer recording, eliminating the need to input program start time, stop time, channel, date and other information which is necessary for ordinary timer programming.

*5 VCR Plus+ and PlusCode are registered trademarks of Gemstar Development Corporation. The VCR Plus+ system is manufactured under license from Gemstar Development Corporation.

Accessories



Remote control unit
(RRMCGA199WJSA)

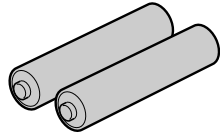

Two "AAA" size batteries
(R-03, UM/SUM-4)
for the remote control unit

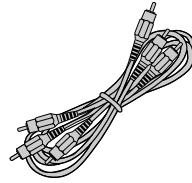

Video/audio cable
(QCNW-A002WJPZ)

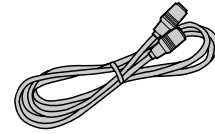

Round coaxial cable
(QCNW-A005WJPZ)

Precautions about Using This Product

Do not use at locations at high temperature.

- If you leave this equipment at a location which rises to an abnormally high temperature (like the inside of a car with the windows shut), this may cause deformation of the cabinet or malfunction. Be very careful not to allow the area around the Recorder or discs to reach a high temperature.

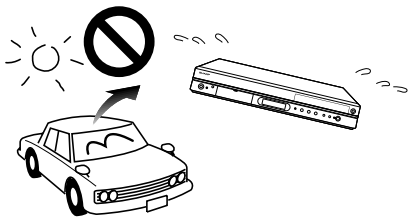

- Do not place the Recorder on any equipment which gets hot.
- Do not place at a location which is exposed to direct sunlight, or near a heater. Be careful because doing so will have an adverse effect on the cabinet and components.

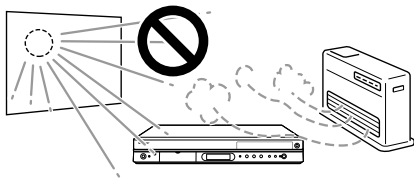

Do not remove the cabinets.

- Do not remove the Recorder cabinets. Touching parts inside the cabinet could result in electric shock and/or damage to the Recorder. For service and adjustment inside the cabinet, please contact the nearest Sharp Authorized Service Center.

Do not cover the fan or ventilation holes on the back of the Recorder.

- When setting up the Recorder, do not cover the fan or ventilation holes on the rear of the Recorder. This will interfere with the cooling fan and cause malfunction. Be especially careful of this point when housing the Recorder in a TV stand or AV rack.
- Do not use the Recorder on carpets, or on a bed or sofa, or wrap the Recorder in cloth or other material. This will interfere with the cooling fan and cause malfunction.

Avoid dust and smoke.

- Do not place the Recorder at a location which is unstable, subject to heavy vibration or where there is a lot of dust or tobacco smoke. Doing so may cause malfunction or accidents.

Set up the Recorder so it is horizontal.

- Do not stand the Recorder up vertically or place it upside down. Doing so will cause malfunction.

Do not place objects on the Recorder.

- Do not place any objects, such as vases or lighted candles on the top of the Recorder.
- Set up at a location where there is adequate space above the Recorder
- Do not place a TV or other heavy object on the Recorder. Doing so may result in problems like noise appearing on the screen, or deformation of the cabinet.



Keep away from magnetic objects.

- Keep the Recorder away from strong magnetic objects.

Handle the Recorder carefully.

- Do not drop the Recorder, or subject it to strong impact or vibration. Doing so will cause malfunction. Be careful when carrying or moving the Recorder.

No fingers or other objects inside.

- Do not put any foreign object on the disc tray.

When moving or shipping the Recorder

- Remove the disc before wrapping the Recorder. In case you will not be using the Recorder for a while, remove the disc, and turn off the power.

When using the Recorder during rain or snow

- If you use the Recorder during rain or snow, be careful not to allow it to get wet.

Dew formation

- Dew may form on the surface of and inside the Recorder if you suddenly carry it from a cold location to a warm location, or use it in a cold room where heating has just been turned on (i.e. on a winter morning). If dew forms, take out the disc and leave the Recorder with the power off until the dew disappears. Using the Recorder with dew formation may cause malfunction. (See page 16.)

Precautions about Using This Product

Upkeep of cabinet

- The cabinet surface employs a lot of plastic. Do not wipe these surfaces with benzene or thinner because this may cause deterioration or paint peeling.

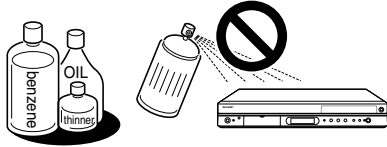

- Do not apply volatile liquids like insecticide to the cabinet. Also, do not allow long-term contact with materials like rubber, vinyl products or synthetic leather. Doing so may cause problems like paint peeling.
- Do not affix stickers or tape to the Recorder. Doing so may cause cabinet discoloration or damage.
- If the cabinet or front panel display gets dirty, gently wipe it off with soft cloth like flannel. If it is extremely dirty, soak a cloth in neutral detergent diluted with water, wring the cloth well, wipe, and then wipe again with a dry cloth. Using powerful cleaners may cause discoloration, deterioration or paint peeling. We recommend testing any cleaners at an inconspicuous location on the Recorder.

Electromagnetic interference

- If you use a mobile phone or other electronic equipment near the Recorder, video may be disturbed or become noisy during playback or recording due to electromagnetic interference.

Antenna

- To avoid the effects of radio interference, set up the antenna at a location away from busy roads, electric wires for train, electric transmission lines and neon signs. This is effective for preventing electric shock accidents in the unlikely event that antenna falls down.
- Do not make the antenna line unnecessarily long, or bundle it. Be careful because doing so will cause the picture to be unstable.
- The antenna is exposed to the weather, so be careful to periodically check and replace it. This will ensure a beautiful picture. Antennas are particularly susceptible to damage at locations with heavy smoke and soot, and locations exposed to sea breeze.

Connected equipment

- Read carefully the "Precautions for Use" in the operation manual for any equipment connected to the Recorder.

Power conservation

- When you are finished using the Recorder, conserve power by turning power off. If you go on a trip, or otherwise will not use the Recorder for a long time, unplug the power cord from the AC outlet to ensure safety.

If you do not use the Recorder for a long time

- Failure to use the Recorder for a long time may cause problems, so turn on power and operate the Recorder from time to time.

Requests regarding setup

- Do not cover the fan or ventilation holes on the back of the Recorder. Doing so will interfere with heat radiation and cause malfunction.

Notes about use

- The Recorder and cabinet may become a little hot, depending on the use environment when using this Recorder. This is not a malfunction.
- When unplugging the power cord (to move the Recorder, etc.), first turn off power (STANDBY indicator on the front of the Recorder lights up red).
- When power is turned on, the fan will rotate to cool the Recorder.
- Immediately after plugging the power cord into an AC outlet, or after recovery from a power failure, the unit may fail to operate for more than ten seconds because the Recorder is performing system adjustment.

Notes about this operation manual



- In this operation manual, the terms "the Recorder", "this Recorder" or "your Recorder" refer to the "DV-SR3U DVD Recorder".
- The screen displays and Recorder illustrations given in this operation manual are for explanatory purposes, and may differ somewhat from the actual screen and Recorder.

About DVD

Types of Discs that Can Be Used with This Recorder

- The following discs can be played back and recorded with this Recorder. Do not use an 8 cm (3") adapter (for CDs).
- Since this Recorder is compatible with the NTSC format, use discs that contain the letters "NTSC" on the disc or package.
- Use discs that are compatible with standards as indicated by the presence of the following logo marks on the disc label. Playback of discs not complying with these standards is not guaranteed. In addition, image quality or sound quality is not guaranteed even if such discs are able to be played back.

Discs For Recording and Playback





| Disc Type | Recording Format | Contents | Disc Size |
|--|-----------------------|-----------------------|---|
|  DVD-RW •Ver. 1.1 •Ver. 1.1 (CPRM compatible) ¹ •Ver. 1.1/2 × (CPRM compatible) ¹ | VR mode Video mode | Audio + Video (Movie) | 12 cm (5"), single-sided/double-sided, single layer disc 8 cm (3"), single-sided, single layer disc ² |
|  DVD-R •Ver. 2.0 •Ver. 2.0/4 × ³ | Video mode | | |

¹ "Copy Once" broadcasts and other programs that can be recorded only once can be recorded.

² DVD-RW/R 8 cm (3") single-sided, single-layer discs can only be used for recording in the Video mode. Some discs of this type may not be able to be recorded.

³ Not compatible with 4X high speed dubbing. When high speed dubbing is used, the system will switch to 2X.

Discs for Playback (Playback Only)

| Disc Type | Recording Format | Contents | Disc Size |
|--|----------------------------------|-----------------------|-------------------------|
|  DVD Video Region number  | Video mode | Audio + Video (Movie) | 12 cm (5") 8 cm (3") |
| DVD+R/DVD+RW | Video mode (finalized disc only) | Audio + Video (Movie) | 12 cm (5") |
|  Video CD | Video CD | Audio + Video (Movie) | 12 cm (5") 8 cm (3") |
|  Audio CD ⁴ | Audio CD (CD-DA) | Audio | |
|  CD-R/CD-RW | Audio CD (CD-DA) | Audio | |
| | MP3 file | | |
| | Video CD | Audio + Video (Movie) | |

⁴ This Recorder has been designed on the premise of playing back Audio CDs that comply with CD (Compact Disc) standards. CDs containing a signal for the purpose of protecting copyrights (copy control signal) may not be able to be played back with this Recorder.

- DVD video players and discs have region numbers, which dictate the regions in which a disc can be played. The region number for this product is **1**. (Discs marked **ALL** will play in any player.)
- DVD Video operations and functions may be different from the explanations in this manual and some operations may be prohibited due to disc manufacturer's setting.
- If "CANNOT OPERATE THIS FUNCTION." or "THIS OPERATION IS PROHIBITED BY THE DISC." is displayed, either the disc or Recorder is prohibiting the function. Read the disc's manual along with this manual.
- If a menu screen or operating instructions are displayed during playback of a disc, follow the operating procedure displayed.

Discs that Cannot Be Used with This Recorder

- **The following discs are unable to be played back or are not played back properly on this Recorder. If such a disc is mistakenly played back, the speakers may be damaged due to the large volume. Never attempt to play back such discs.**

CDG, Photo CD, CD-ROM, CD-TEXT, CD-EXTRA, SVCD, SACD, PD, CDV, CVD, DVD-ROM, DVD-RAM, DVD-Audio

- **Discs with unusual shapes cannot be played.**

- Discs with unusual shapes (heart-shaped or hexagonal discs, etc.) cannot be used. The use of such discs will cause a fault.

- **The following DVD video discs cannot be played.**

- Discs not containing "1" or "ALL" for the region number (discs sold outside the authorized marketing area).⁵
- Discs recorded in PAL format.⁶
- Discs produced illegally.
- Discs recorded for commercial use.

⁵ The region number for this product is 1.

⁶ This Recorder is compatible with the NTSC format. Make sure to check the format of the disc before purchasing.

- **The following DVD-RW/R, DVD+RW/R discs cannot be played.**

- Discs on which data has not been recorded cannot be played back.
- Discs may not be played back depending on the recorder used for recording.

- **The following Audio CD discs cannot be played.**

- Discs containing a signal for the purpose of protecting copyrights (copy control signal) may not be played back with this Recorder.
- This Recorder has been designed on the premise of playing back Audio CDs that comply with CD (Compact Disc) standards.

- **The following CD-RW/R discs cannot be played.**

- Discs on which data has not been recorded cannot be played back.
- Non-finalized discs cannot be played back.
- Discs recorded in a format other than a Video CD/Audio CD and MP3 file format⁷ cannot be played back.
- Discs may not be played back depending on their recording status or the status of the disc itself.
- Discs may not be played back depending on their compatibility with this Recorder or the recorder used for recording.

*7 About MP3 file format

MP3 files are audio data compressed in MPEG1 Audio layer 3 file format. "MP3 files" have ".mp3" as extensions. (Some files that have ".mp3" extensions or files that have not been recorded in MP3 format will produce noise or cannot be played.)

● Playing MP3 discs

- Some MP3 files are not played in the order they were recorded.
- The maximum number of layers which can be recognized, including files and folders, is 8.
- The multi-session discs cannot be played.
- It is recommended to record data at a lower speed as data recorded at fast speed can produce noise and may not be able to be played.
- The more folders there are, the longer the reading time.
- Depending on the folder tree, reading MP3 files can take time.
- Folder or track (file) names are limited to 8 characters. Folder or track (file) names that go over 8 characters will be abbreviated. (Certain letters or symbols in folder names or title name may not be displayed.)
- The playing time may not be correctly displayed during MP3 file playback.

● The following files cannot be played on this Recorder.

- Discs that have more than 257 folders or 1,000 files.
- When both Audio CD format and MP3 files format are recorded on a disc. (The disc is recognized to be an Audio CD and only tracks in the Audio CD format are played back.)

Types of Discs for Recording

- DVD-RW and DVD-R discs can be recorded with this Recorder. The recording format that can be selected may vary according to the disc version and type of disc.
- Make sure to use a disc that has the words "For Video" or "For Recording" on the disc or disc jacket for recording and playback with this Recorder.

| Disc Type | Recording Format | |
|--|------------------|------------|
| | VR mode | Video mode |
| DVD-RW Ver. 1.1 DVD-RW Ver. 1.1 (CPRM) | × | × |
| DVD-RW Ver. 1.1/2× (CPRM) | — | — |
| DVD-R Ver. 2.0 DVD-R Ver. 2.0/4× | — | × |

DVD-RW Discs

- DVD-RW discs are available in Ver. 1.1, Ver. 1.1 (CPRM compatible) or Ver. 1.1/2× (CPRM compatible).
 - When a disc has been recorded in the VR mode, it can be recorded and erased repeatedly. Erasure also allows the recording time to be increased.
 - When a disc has been recorded in the Video mode, additional recording is possible until the disc is full. The recording time does not increase^{*8} even if titles are erased, but if the disc is initialized (see pages **14** and **84**) full recording time is possible.
- ^{*8} Recording time can only be increased when the last title is erased (titles cannot be erased after a disc has been finalized).

DVD-R Discs

- DVD-R discs can only be recorded in the Video mode.
- Although additional recordings can be made until the disc is full, disc space does not increase even if titles are erased (because erasure here refers only to making the titles not visible).
- Although these discs can be played back with other DVD players once they have been finalized, the discs can no longer be recorded or erased after they have been finalized.
- Discs can be additionally recorded and edited with this Recorder only until they are finalized.

About DVD

Recording Formats

- There are two recording formats available with this Recorder: the VR mode and the Video mode.
- The recording format that can be selected may differ depending on the disc. Refer to the section on Types of Discs for Recording (page 11).
- Recording in the VR mode and Video mode cannot be mixed on one disc.

VR (Video Recording) Mode

The VR mode is the basic DVD-RW recording format, and lets you enjoy the various editing functions available with this Recorder.

- When a disc has been recorded in the VR mode, it can be recorded and erased repeatedly. Erasure also allows the recording time to be increased.
- Recorded discs can only be played back with DVD-RW compatible DVD players⁹.
- "Copy Once" programs can also be recorded¹⁰.

- ⁹
- Although there are some cases in which the disc must be finalized, the disc can be recorded and erased after it has been finalized.
 - DVD-RW compatible DVD players have the following indication.

RW
COMPATIBLE

DVD players with this indication have the function of being able to play back DVD-RW discs recorded in the VR mode with a DVD recorder.

- ¹⁰ When using a DVD-RW Ver. 1.1 disc (CPRM compatible). Recorded programs cannot be played back with other DVD players (including DVD-RW players) or DVD recorders not compatible with CPRM.

Video Mode

This recording format is compatible with commercially available DVD players and DVD-ROM drives.

- Discs recorded in the Video mode cannot be recorded repeatedly or their content overwritten.
- When recording in the Video mode, discs can be played back, additionally recorded and edited only with this Recorder until they are finalized. Editing functions are limited.
- Discs recorded in the Video mode can be played back with other DVD players by finalizing them after recording. (However, this does not guarantee that these discs can be played back on all DVD players.)
- Recordings onto DVD-RW/R discs using the Video mode employ a new standard approved by the DVD Forum in 2000, and compatibility with this standard is left to the discretion of the respective DVD player manufacturer. Consequently, there are some models of DVD players and DVD-ROM drives that are unable to play back DVD-RW/R discs.
- "Copy Once" programs cannot be recorded.

Recording Time

- The recording mode that can be set varies according to the recording format. Refer to the table below for the applicable recording mode.

| Recording Mode | Recordable Time | Description |
|----------------|-------------------|--|
| FINE | About 60 minutes | When you want to record high-quality images. |
| SP | About 120 minutes | This is the standard recording mode. |
| LP | About 240 minutes | When you want to record for a long period of time with slightly lower image quality. |
| EP | About 360 minutes | When you want to place priority on recording time. |

- Recordable time is based on the recording time when using a 4.7 GB disc. Since recording capacity varies according to the recorded material, there may be cases where there is much more disc space remaining on the disc when recording is completed.
- Refer to page 36 about the recordable times when you choose "MN" (manual) Recording mode.
- * Since recording to DVD is performed using VBR (variable bit rate, refer to the section on VBR Control on page 93) with the exception of some recording modes, recording time varies according to the material to be recorded.





- Recordable time may be shorter than that indicated above in the case of recording material of poor image quality such as broadcasts from televisions with poor reception.
- This does not guarantee the length of recording time. Actual recording time may be shorter than that indicated above depending on image quality and other aspects.
- The total of recording time and remaining time may not always agree with the recordable time of the recording mode.
- Block-like images may become conspicuous during scenes containing rapid movement due to the characteristics of digital image compression technology.

Disc Remaining Time

- **VR mode**
 - Additional recordings can be made as long as there is available space on the disc. (Additional recordings can also be made after the disc is finalized.)
 - Erasing unnecessary recordings lets you increase the remaining time on the disc. (The disc can also be erased after it has been finalized.)
 - When a Play List (see page 68) is created, disc space will not increase even if portions of titles or titles of Play List are erased.
- **Video mode**
 - Additional recordings can be made with this Recorder provided there is available space on the disc until the disc is finalized.
 - In case you record on a DVD-RW disc, recordable time will increase if you erase the last recorded title unless you finalize the DVD-RW disc.
 - In case you record on a DVD-R disc, recordable time will not increase even if you erase titles (see page 67). (The erase function only hides the title, it does not actually erase it. It does not actually delete the recorded contents.)

Using the Proper Disc

Select the disc and recording format to be used according to the objective of the recording. Select the disc and recording format by referring to the table below.

| Objective | Disc Used | Recording Format |
|---|--|-------------------------------------|
| <ul style="list-style-type: none"> When you want to play back a recorded disc with a DVD player or DVD Video compatible PC When not re-recording a recorded disc (when making a permanent recording or when you do not want the recording to be erased) | Recordable DVD-R disc  | Video mode recording + finalization |
| <ul style="list-style-type: none"> When you want to play back a recorded disc with a DVD player or DVD Video compatible PC When you want to repeatedly record and erase a recorded disc | Recordable DVD-RW disc Ver. 1.1 or Ver. 1.1 (CPRM compatible)  | Video mode recording + finalization |
| <ul style="list-style-type: none"> When you want to edit a disc recorded with this Recorder When playing back with a DVD-RW compatible player with the following indication  When you want to repeatedly record and erase a recorded disc | Recordable DVD-RW disc Ver. 1.1 or Ver. 1.1 (CPRM compatible)  | VR mode recording + (finalization) |
| <ul style="list-style-type: none"> When you want to record a "Copy Once" satellite broadcast, etc. | Recordable DVD-RW disc Ver. 1.1 (CPRM compatible)  | VR mode recording |

Time Display for Recording and Playback (Video mode only)

- With this Recorder, the displayed record/playback time is about 0.1% shorter than the actual recording time. In video like TV broadcasts, video is sent at a rate of about 29.9 frames per second. For convenience, this Recorder calculates using a value of 30 frames per second. (If, for example, you record one hour, the time display on the Recorder will be: 60 minutes \times 0.999 = 59.94 minutes = 59 mins. 56 secs.)

Unrecordable Material

- This Recorder is equipped with a copy guard function that prevents recording of video software or broadcast programs that contain a signal that restricts copying in accordance with copyrights and so forth.
 Example:
 - DVD videos
 - PPV (pay-per-view) broadcasts
- The proper image may not be obtained in the case a copy guard signal is contained in the images input from equipment connected to the external input jacks (LINE IN 1, LINE IN 2, LINE IN 3) of this Recorder.
 Example:
 - Images not output at proper brightness
 - Incorrect output of picture size and other data
 Connect such equipment directly to your TV without going through this Recorder.
- In the case a copy guard signal is contained in a source video that occurs part way through recording, recording is paused at that point. Recording resumes when the copy guard signal is no longer present, while no recordings will be made for the part where the copy prevention signal is present.

Initialization and Finalization

Initialization (Formatting)

Initialization is required when using DVD-RW discs in the Video mode. (See page 84 for details about Initialization.)

When an unused DVD-RW disc is placed in the Recorder immediately after the disc has been purchased, the Recorder is set to automatically begin initializing in the VR mode. The settings can also be changed so that discs are initialized in the Video mode (page 84).

When using a DVD-RW disc in the Video mode without changing this setting, initialize the disc in the Video mode after first completing initialization in the VR mode (page 84).

- Initialization causes the entire previously recorded contents of the disc to be erased.
- It takes about 1 minute to 1 minute and 30 seconds for initialization to be completed.

Allowing Discs to Be Played Back with Other DVD Players (Finalization)

Discs must always be finalized in order to play them back with another DVD player after having been recorded in the Video mode. (See page 84 for details about Finalization)

Finalize discs on which all recordings have been completed so that they can be viewed with another DVD player or a DVD Video compatible PC. Discs that are not finalized may not be able to be played back with other DVD players or DVD Video compatible PCs. (However, this does not guarantee that finalized discs can be played back on all DVD players or DVD Video compatible PCs.)

- Finalizing a DVD-R disc prevents all recording and editing of that disc.
- Although DVD-RW discs can be re-recorded by initializing even after they have been recorded in the Video mode and finalized, all previously recorded contents are erased.
- Finalization is required if a disc recorded in the VR mode cannot be played back with a DVD-RW compatible player. (Discs formatted in the VR mode can be recorded and edited even after finalization.)
- Finalization takes from several minutes to about an hour. (Processing takes longer if there is considerable available space on the disc.)

The following operations may cause malfunction.

- Operating discs recorded or edited by this Recorder in a DVD recorder or PC's DVD drive manufactured by other manufacturers.
- Using the discs in above situation again with this Recorder.
- Operating discs recorded or edited by a DVD recorder or PC's DVD drive made by other manufacturers than the one for this Recorder.

About the Contents of the Disc

Title, Chapter and Track

- DVDs are divided into "Titles" and "Chapters". If the disc has more than one movie on it, each movie would be a separate "Title". "Chapters", on the other hand, are subdivisions of titles. (See Example 1.)
- Video CDs and Audio CDs are divided into "Tracks". You can think of a "Track" as one tune on an Audio CD. (See Example 2.)

Recording on a DVD-RW/R disc

- One recording is treated as one title and the chapters will be inserted automatically every 10 minutes. You can choose the chapter interval from the following: 10 minutes, 15 minutes, 30 minutes, or off (page 76).
- Each title, chapter and track will be numbered in order. Title, chapter and track may not be numbered in some discs.

Recording on a DVD-RW disc in VR mode

- When you pause during recording or erase the scene using edit function, chapter marks will be inserted automatically. You can also insert chapter marks at your favorite scenes (page 65).

Recording in Video mode

- You cannot insert chapter marks at your favorite scenes.

Example 1: DVD

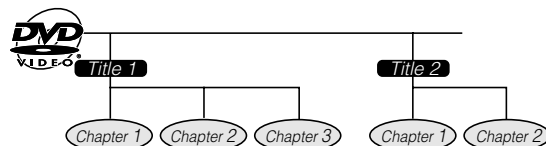

Example 2: Video CD or Audio CD



Icons Used on DVD Video Disc Case

When you buy a DVD Video disc, the back of the disc case usually contains various information about the contents of the disc.

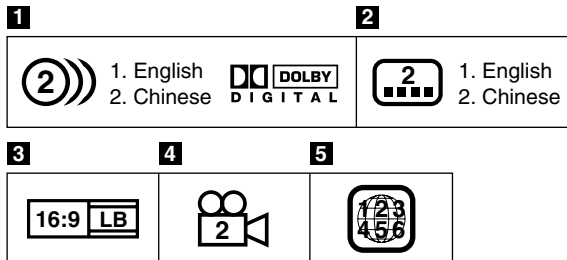

1 Audio tracks and audio formats

DVD discs can contain up to 8 separate tracks with a different language on each. The first in the list is the original track.

This section also details the audio format of each soundtrack—Dolby Digital, DTS, etc.

Dolby Digital

A sound system developed by Dolby Laboratories Inc. that gives movie theater ambience to audio output when the Recorder is connected to a Dolby Digital 5.1 channel processor or amplifier.

DTS

DTS is a digital sound system developed by Digital Theater Systems for use in cinemas. This system uses 6 audio channels and provides accurate sound field positioning and realistic acoustics. (By connecting a DTS Digital Surround decoder, you can also listen to DTS Digital Surround sound.)

Linear PCM

Linear PCM is a signal recording format used for Audio CDs.

The sound on Audio CDs is recorded at 44.1 kHz with 16 bits. (On DVD discs, sound is recorded at between 48 kHz with 16 bits and 96 kHz with 24 bits.)

2 Subtitle languages

This indicates the kind of subtitles.

3 Screen aspect ratio

Movies are shot in a variety of screen modes.









4 Camera angle

Recorded onto some DVD discs are scenes which have been simultaneously shot from a number of different angles (the same scene is shot from the front, from the left side, from the right side, etc.).

5 Region code

This indicates the region code (playable region number).

The Icons Used in This Operation Manual

-   ... Indicates the functions that can be performed for DVD-R discs.
 - VR MODE:**
 - Indicates that the function will operate when recording in VR mode or playing back a disc recorded in VR mode.
 - VIDEO MODE:**
 - Indicates that the function will operate when recording in Video mode or playing back a disc recorded in Video mode.
-  Indicates the functions that can be performed for DVD-R discs.
-  Indicates the functions that can be performed for DVD Video discs.
-  Indicates the functions that can be performed for Video CDs.
-  Indicates the functions that can be performed for Audio CDs.
-  Indicates the functions that can be performed for CD-R discs in MP3 format.
-  Indicates the functions that can be performed for CD-RW discs in MP3 format.





Important Information

Disc Precautions

Be Careful of Scratches and Dust

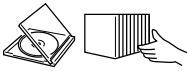
- DVD-R and DVD-RW discs are sensitive to dust, fingerprints and especially scratches. A scratched disc may not be able to be recorded, or important data recorded may not be able to be played back. Handle discs with care and store them in a safe place.

Proper Disc Storage

| | |
|---|---|
| Place the disc in the center of the disc case and store the case and disc upright. |  |
| Avoid storing discs in locations subject to direct sunlight, next to heating appliances or in locations of high humidity. |  |
| Do not drop discs or subject them to strong vibrations or impacts. |  |
| Avoid storing discs in locations where there are large amounts of dust or locations where mold tends to grow easily. |  |

Handling Precautions

- If the surface is soiled, wipe gently with a soft, damp (water only) cloth. When wiping discs, always move the cloth from the center hole toward the outer edge.



- Do not use record cleaning sprays, benzene, thinner, static electricity prevention liquids or any other solvent.
- Do not touch the surface.
- Do not stick paper or adhesive labels to the disc.
- If the playing surface of a disc is soiled or scratched, the Recorder may decide that the disc is incompatible and eject the disc tray, or it may fail to play the disc correctly. Wipe any soiling off the playing surface with a soft cloth.

Cleaning the Pick Up Lens

- Never use commercially available cleaning discs. The use of these discs can damage the lens.
- Request cleaning of the lens to the nearest Sharp Authorized Service Center.

Warning of Dew Formation

- Dew may form on pick up lens or disc in the following conditions:

- Immediately after a heater has been turned on.
- In a steamy or very humid room.
- When the Recorder is suddenly moved from a cold environment to a warm one.

When dew forms:

It becomes difficult for the Recorder to read the signals on the disc and prevents the Recorder from operating properly.

To remove dew:

Take out the disc and leave the Recorder with the power off until the dew disappears. Using the Recorder with dew formation may cause malfunction.

Copyright

- It is the intent of Sharp that this product be used in full compliance with the copyright laws of the United States and that prior permission be obtained from copyright owners whenever necessary.
- This product incorporates copyright protection technology that is protected by method claims of certain U.S. patents and other intellectual property right owned by Macrovision Corporation and other rights owners. Use of this copyright protection technology must be authorized by Macrovision Corporation, and is intended for home and other limited viewing uses only unless otherwise authorized by Macrovision Corporation. Reverse engineering or disassembly is prohibited.

Apparatus Claims of U.S. Patent Nos. 4,631,603, 4,577,216, 4,819,098 and 4,907,093 licensed for limited viewing uses only.

- Manufactured under license from Dolby Laboratories. "Dolby" and the double-D symbol are trademarks of Dolby Laboratories.
- "DTS" and "DTS Digital Out" are trademarks of Digital Theater Systems, Inc.
- Certain audio features of this product manufactured under a license from Desper Products, Inc. *Spatializer*[®] N-2-2[™] and the circle-in-square device are trademarks owned by Desper Products, Inc.
- The DVD logo is a registered trademark.
- i.LINK refers to the IEEE 1394-1995 industry specification and extensions thereof. The  logo is used for products compliant with the i.LINK standard.
-  is a trademark.
- VCR Plus+ and PlusCode are registered trademarks of Gemstar Development Corporation. The VCR Plus+ system is manufactured under license from Gemstar Development Corporation.

"Licensed under one or more of U.S. Pat. 4,972,484, 5,214,678, 5,323,396, 5,530,655, 5,539,829, 5,544,247, 5,606,618, 5,610,985, 5,740,317, 5,777,992, 5,878,080 or 5,960,037."

Cautions Regarding Recording

- **Always Make Sure to Test Record First**
 - Make a test recording with a DVD-RW disc first before making any important recordings to confirm whether or not the recorded material is recorded properly.
- **Compensation for Recordings**
 - In the event a recording is unable to be made due to a problem with this Recorder or a disc, or due to an external factor such as a power failure or condensation of moisture and so forth, the manufacturer is not responsible for compensation for unrecorded contents or incidental damages.

Major Components

Main Unit (Front)

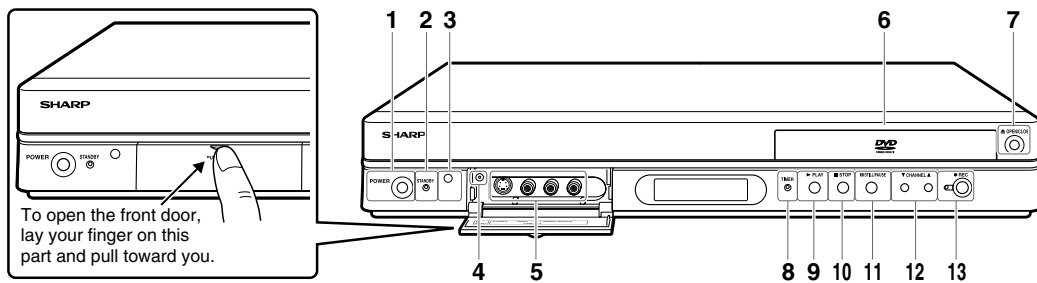

- 1 POWER (p. 25)
- 2 STANDBY indicator (p. 25)
- 3 Remote sensor (p. 19)
- 4 RESET (p. 88)
- 5 LINE IN 3 (p. 75)
 - AUDIO Input jacks
 - VIDEO Input jack
 - S-VIDEO Input jack
- 6 Disc tray (p. 34)
- 7 OPEN/CLOSE (p. 34)
- 8 TIMER indicator (p. 38)
- 9 ► PLAY (p. 47)
- 10 ■ STOP (pp. 35, 47)
- 11 || STILL/PAUSE (pp. 35, 50)
- 12 CHANNEL ▼/▲
- 13 ● REC (p. 35)

Front Panel Display

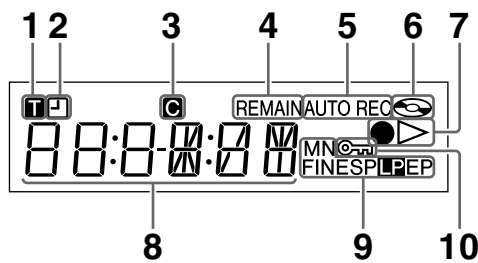

- 1 Title indicator (p. 33)
- 2 Simple Recording Timer indicator (p. 35)
- 3 Chapter indicator (p. 33)
- 4 Disc Remaining Time indicator (p. 33)
- 5 AV AUTO REC indicator (p. 44)
- 6 DISC IN indicator
- 7 Recording indicator (●) (p. 35)
- Play indicator (►) (p. 47)
- 8 Information Display (p. 33)
- 9 Recording Mode indicator (p. 35)
- 10 Tamper Proof indicator (p. 34)

Main Unit (Rear)

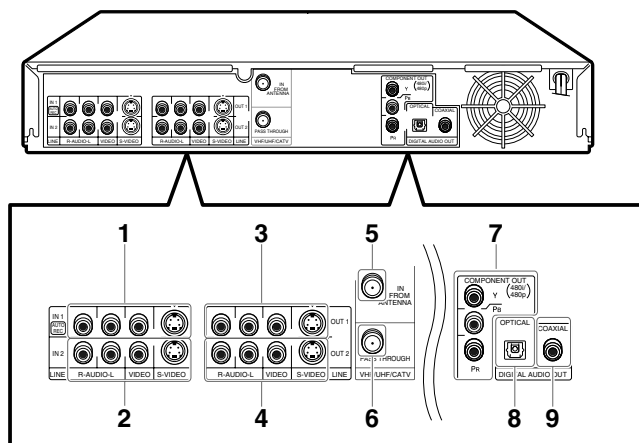

- 1 LINE IN 1 (AUTO REC) (p. 44)
 - AUDIO Input jacks
 - VIDEO Input jack
 - S-VIDEO Input jack
- 2 LINE IN 2
 - AUDIO Input jacks
 - VIDEO Input jack
 - S-VIDEO Input jack
- 3 LINE OUT 1 (p. 21)
 - AUDIO Output jacks
 - VIDEO Output jack
 - S-VIDEO Output jack
- 4 LINE OUT 2 (p. 73)
 - AUDIO Output jacks
 - VIDEO Output jack
 - S-VIDEO Output jack
- 5 IN FROM ANTENNA jack (antenna or cable input) (p. 21)
- 6 PASS THROUGH jack (p. 21)
- 7 COMPONENT Video Output jacks (p. 22)
- 8 DIGITAL AUDIO Output OPTICAL terminal (p. 73)
- 9 DIGITAL AUDIO Output COAXIAL jack (p. 73)

Major Components

Remote Control Unit

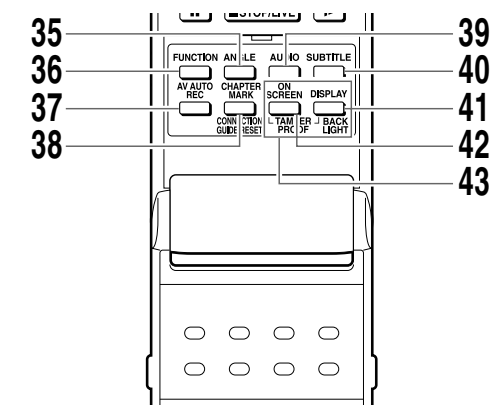
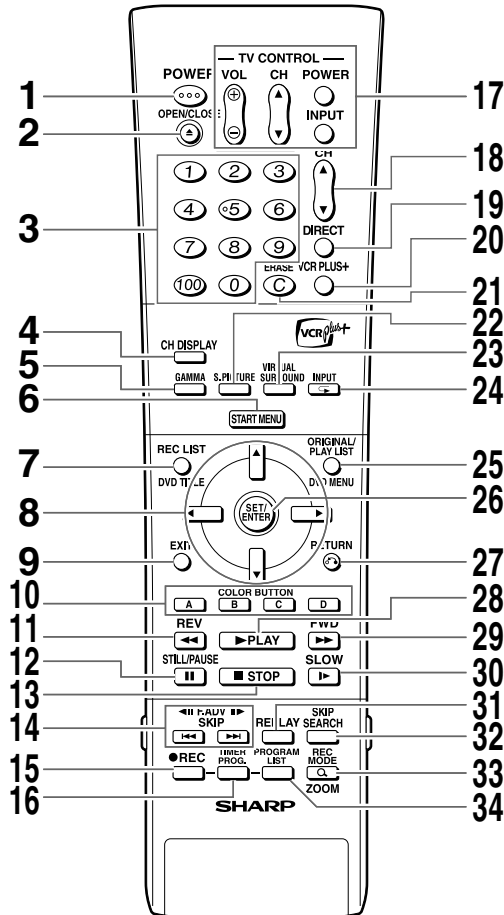

NOTE

- Buttons marked with "*" are made of luminous rubber for easy visibility even in the dark. (The degree of brightness will decrease as time passes.)

- 1 POWER (p. 25)
- 2 ▲ OPEN/CLOSE (p. 34)
- 3 Number buttons (pp. 20, 39)
- 4 CH DISPLAY (p. 32)
- 5 GAMMA (p. 54)
- 6* START MENU (p. 28)
- 7* REC LIST/DVD TITLE (pp. 47, 53)
- 8* Cursor buttons (▲/▼/◀/▶) (pp. 26, 28)
- 9* EXIT (p. 28)
- 10* COLOR BUTTON (pp. 37, 47)
Blue (A), Red (B), Green (C), Yellow (D)
- 11 ◀◀ REV (p. 49)
- 12* ■■ STILL/PAUSE (pp. 35, 50)
- 13* ■ STOP (pp. 35, 47)
- 14* ◀◀ F.ADV ▶▶, ◀◀ SKIP ▶▶▶ (pp. 49, 50)
- 15 ● REC (p. 35)
- 16 TIMER PROG. (p. 37)
- 17 TV CONTROL buttons (p. 20)
- 18 CH ▼/▲
- 19 DIRECT (p. 50)
- 20 VCR PLUS+ (p. 39)
- 21 ERASE (p. 39)
- 22 S. PICTURE (p. 54)
- 23 VIRTUAL SURROUND (p. 54)
- 24 INPUT / Repeat (pp. 51, 75)
- 25 ORIGINAL / PLAY LIST / DVD MENU
(pp. 47, 53, 59)
- 26* SET / ENTER (pp. 26, 28)
- 27* ↻ RETURN (p. 28)
- 28▶▶▶ PLAY (p. 47)
- 29*▶▶▶ FWD (p. 49)
- 30*▶▶ SLOW (p. 50)
- 31 REPLAY (p. 50)
- 32 SKIP SEARCH (p. 50)
- 33 REC MODE / ZOOM (pp. 35, 52)
- 34 PROGRAM LIST (p. 43)
- 35 ANGLE (p. 52)
- 36 FUNCTION (p. 56)
- 37 AV AUTO REC (p. 44)
- 38 CHAPTER MARK / CONNECTION GUIDE / RESET
(pp. 26, 48, 65)
- 39 AUDIO (pp. 32, 51)
- 40 SUBTITLE (p. 52)
- 41 DISPLAY / BACKLIGHT (pp. 33, 38)
- 42 ON SCREEN (p. 32)
- 43 TAMPER PROOF (p. 34)

Loading the Batteries

1 While pressing  down, slide the battery cover in the direction of the arrow.

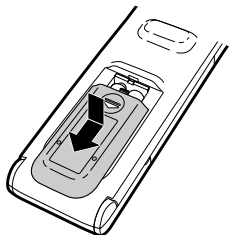

2 Load the batteries. Load the two "AAA" size batteries (R-03, UM/SUM-4) supplied with the remote control unit. Make sure that the battery poles \oplus and \ominus are positioned as indicated.

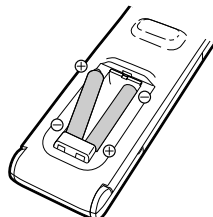

3 Slide the battery cover in the direction of the arrow until it clicks.

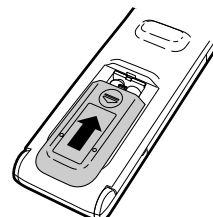

NOTE

- Do not subject the remote control unit to shock, water or excessive humidity.
- The remote control unit may not function if the Recorder's remote sensor is in direct sunlight or any other strong light.
- Incorrect use of batteries may cause them to leak or burst. Read the battery warnings and use the batteries properly.
- Do not mix old and new batteries, or mix different brands.
- Remove the batteries if you will not use the remote control unit for an extended period of time.

Operating range of remote control

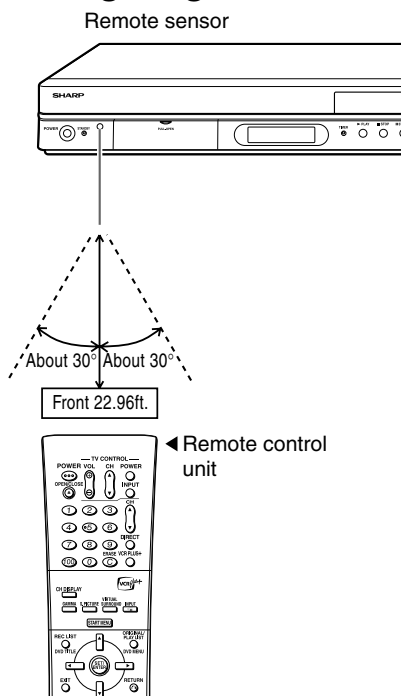

Major Components

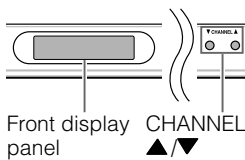
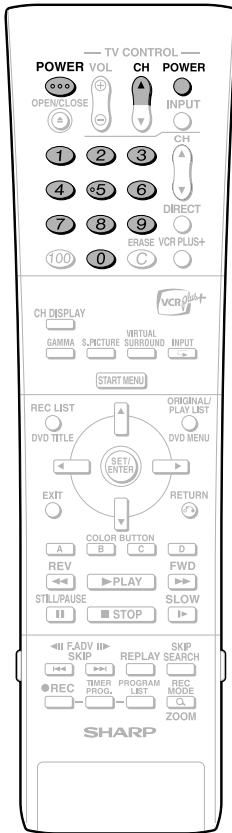

Operating a TV Using the Remote Control (Universal Remote Control)

The Universal Remote Control may operate the basic functions of 21 different types of TVs. To enter the Manufacturer's Code for your TV, follow the instructions below.

There is no guarantee that the universal remote control will function with your TV.

Setting the Manufacturer's Code

- 1** Press **POWER** and **CH ▲** of **TV CONTROL** simultaneously.
- 2** Enter the 2-digit Manufacturer's Code with the **Number** buttons (Ex. 02-"0", "2") within **10 seconds** after releasing **POWER** and **CH ▲** of **TV CONTROL**.
- 3** Point the remote control unit towards the TV and then press **POWER** of **TV CONTROL**.

- If the TV turns on/off, setup was successful. If not, repeat the procedure using another code.

See the list below for the Manufacturer's Code and the buttons which work with each brand.

| Buttons on the Remote | | POWER CH ▲▼ VOL ⊕/⊖ | INPUT |
|-----------------------|--------|---------------------|-------|
| Brand | Code | | |
| EMERSON | 19 | x | x |
| FISHER | 17 | x | x |
| FUNAI | 06 | x | x |
| GE | 07, 09 | x | — |
| GOLDSTAR | 18 | x | — |
| HITACHI | 15 | x | x |
| JVC | 16 | x | x |
| MAGNAVOX | 09, 11 | x | x |
| MITSUBISHI | 14 | x | x |
| PANASONIC | 13, 21 | x | x |
| PIONEER | 03 | x | x |
| RCA | 07, 09 | x | — |
| SAMSUNG | 20 | x | x |
| SANYO | 17 | x | x |
| SHARP | 01, 02 | x | x |
| SONY | 10 | x | x |
| TECHNOL ACE | 04 | x | x |
| TOSHIBA | 12 | x | x |
| ZENITH | 05, 08 | x | — |

NOTE

- If the batteries in the remote control unit are changed, the code settings must be re-entered.
- Some brands have more than one code listed above, due to changes in the codes. In such cases, try another code to find the code that operates your TV.

Setting the Remote Control Code

- Two types of remote control codes operate this Recorder: RC-1 and RC-2. If you operate this Recorder by remote control along with another SHARP DVD recorder or DVD player placed next to it simultaneously, switching the remote control code (both the Recorder and remote control) to one of the signals (RC-1 or RC-2) will let you operate only with this Recorder.
- Make sure to set the Recorder and remote control to the same remote code. You can not operate the Recorder if they are not set to the same code.

Setting the Remote Control Code of the Remote

Example: Setting the code to "RC-2".

- 1** Press and hold **POWER** and **2** together for more than **5 seconds**.
- 2** Press **POWER** of this Recorder to see if you can turn it on/off.
 - If you cannot, go to step **3**.

NOTE

- The remote control code of the remote becomes "RC-1" when you change the batteries.

Setting the Remote Control Code of the Recorder

- 3** Press **POWER** to turn off the Recorder.
- 4** Press and hold **CHANNEL ▼** and **▲** on the Recorder together for more than **5 seconds**.
 - Each time this operation is performed, the code of the Recorder toggles between "RC-1" and "RC-2". The front panel display changes as the code changes.
 - Press **POWER** on the remote control to see if you can turn on/off the Recorder.

If remote control does not work

Press **POWER** on the remote control and check the front panel display (RC-1 or RC-2). Set the remote control code according to the display and press **POWER** to see if you can turn on/off the Recorder.

Basic Connection

Easy Connection

The following connection is the basic connection to watch or record TV programs. To use a cable box or satellite receiver, see "CATV or Satellite Receiver Connections" on pages 23 and 24.

! Important!

- Be sure to turn off and unplug from the AC outlet this Recorder and all equipment before connecting the cables.
- This Recorder is equipped with copy protection technology. The playback picture from this Recorder will not appear correctly on your TV when you connect this Recorder to your TV via a VCR (or your VCR via this Recorder) using video/audio cables.

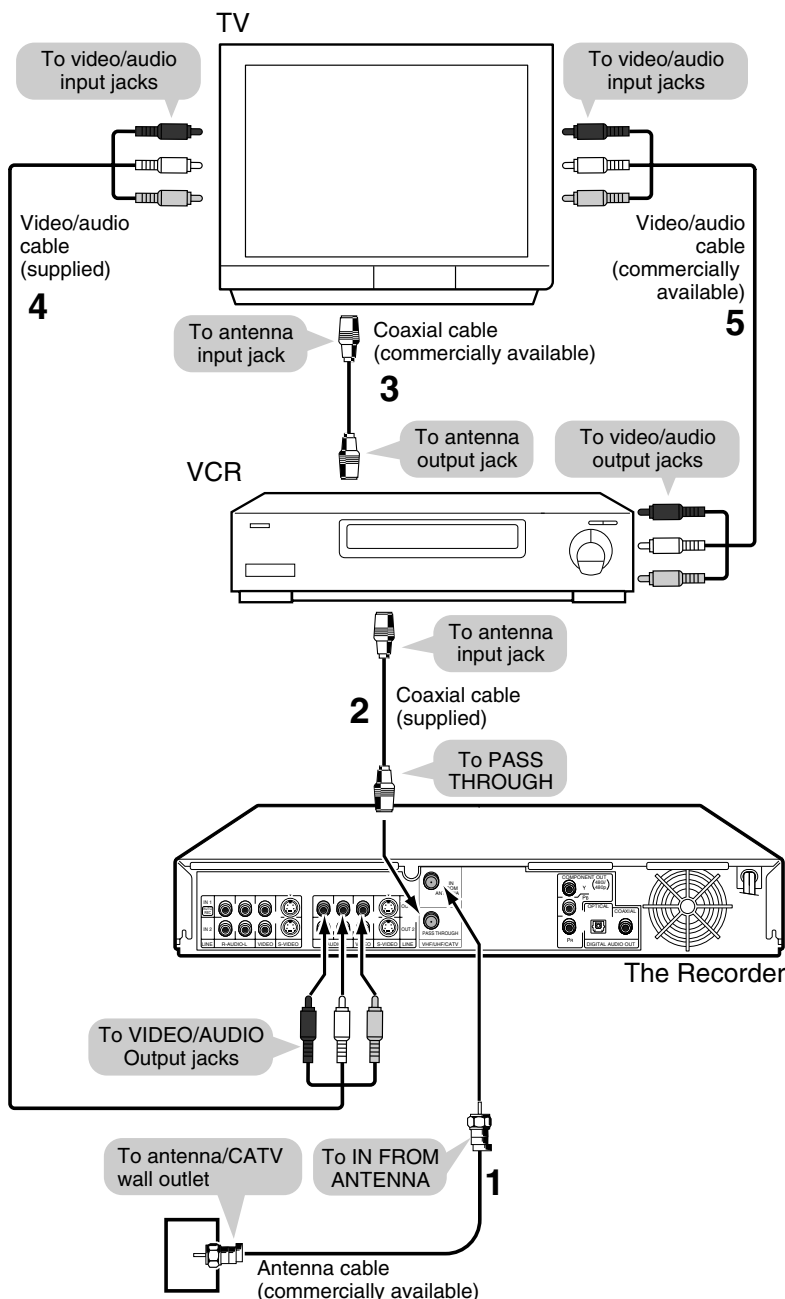

- 1** Connect the TV antenna cable to the **IN FROM ANTENNA** jack on the rear of this Recorder.
- 2** Connect the **PASS THROUGH** jack on the rear of this Recorder to the **antenna input jack** on your **VCR** using the **supplied coaxial cable**.

NOTE

- If you connect this Recorder directly to your TV, skip the next step.

- 3** Connect the **antenna output jack** on your **VCR** to **antenna input jack** on your **TV** using a **coaxial cable**.
- 4** Connect the **VIDEO/AUDIO Output jacks** on this **Recorder** to the **video/audio input jacks** on your **TV** using the **supplied video/audio cable**.

Be sure that the colors of the jacks and plugs match up when connecting the cable.

NOTE

- To connect using S-video or component cables, see "Using Other Types of Video Output" on page 22.

- 5** Connect the **video/audio output jacks** on your **VCR** to the **video/audio input jacks** on your **TV** using a **video/audio cable**.

! Important!

- When using this connection, set "PROGRESSIVE OUT" to "PROGRESSIVE SCAN OFF" (see page 80).

After the connection

Plug in the power cords of the TV and VCR. Then go to "EZ Set Up" (see page 25).

Basic Connection

Using Other Types of Video Output

In order to view clearer DVD images, it is recommended that you use a commercially available S-video or component video cable when connecting your TV to the video output.

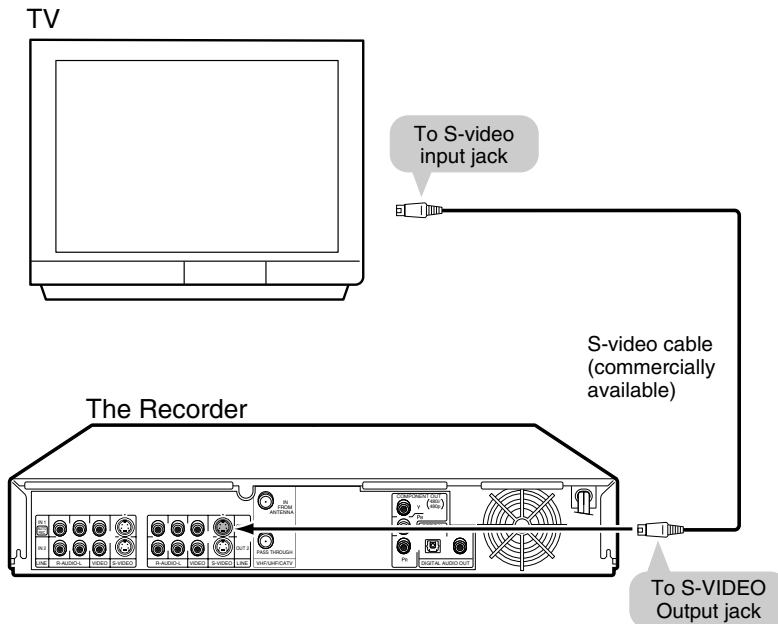

Connecting Using an S-VIDEO Output

Connect the S-VIDEO Output jack on this Recorder to the S-video input jack on your TV using an S-video cable (commercially available).

! Important!

- When using this connection, set "PROGRESSIVE OUT" to "PROGRESSIVE SCAN OFF" (see page 80).

After the connection

Plug in the power cord of the TV. Then go to "EZ Set Up" (see page 25).

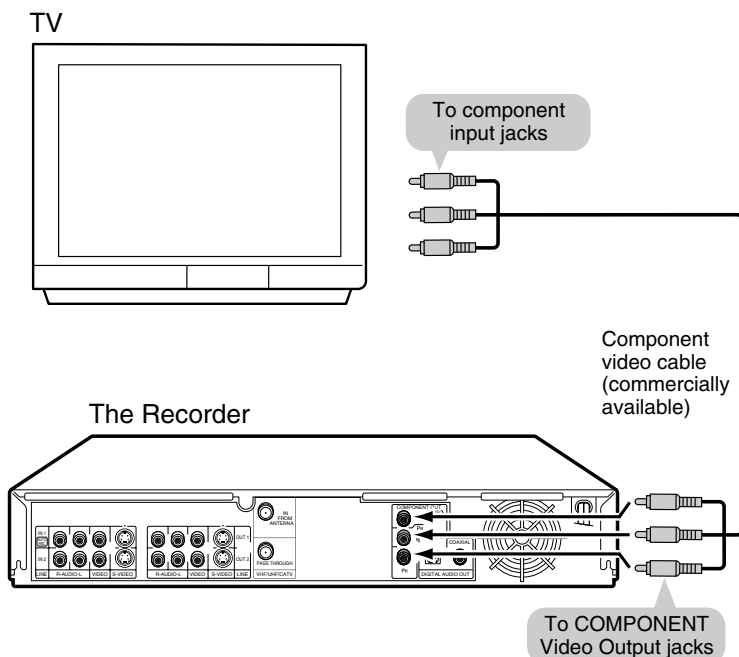

Connecting Using the COMPONENT Video Output

Connect the COMPONENT OUT jacks on this Recorder to the component input jacks on your TV using a component video cable (commercially available).

! Important!

- When using this connection:
 - If your TV is compatible with progressive-scan component video, set "PROGRESSIVE OUT" to "PROGRESSIVE SCAN ON" (see page 80).
 - If not, set it to "PROGRESSIVE SCAN OFF".

After the connection

Plug in the power cord of the TV. Then go to "EZ Set Up" (see page 25).

CATV or Satellite Receiver Connections

Connecting to a Cable Box or Satellite Receiver (1)

The following connection is the connection to a cable box or satellite receiver when receiving only a few scrambled channels. When many or all the channels are scrambled, see the connection on page 24.

Using this connection, you can:

- Record unscrambled CATV signals by selecting them on this Recorder.
- Record scrambled CATV signals by selecting them on the cable box or satellite receiver and selecting the input used on the Recorder.
- Record a channel while you watch another.
- Record using the "AV AUTO REC" function (see page 44) when LINE IN 1 is used for cable box/satellite receiver connection.

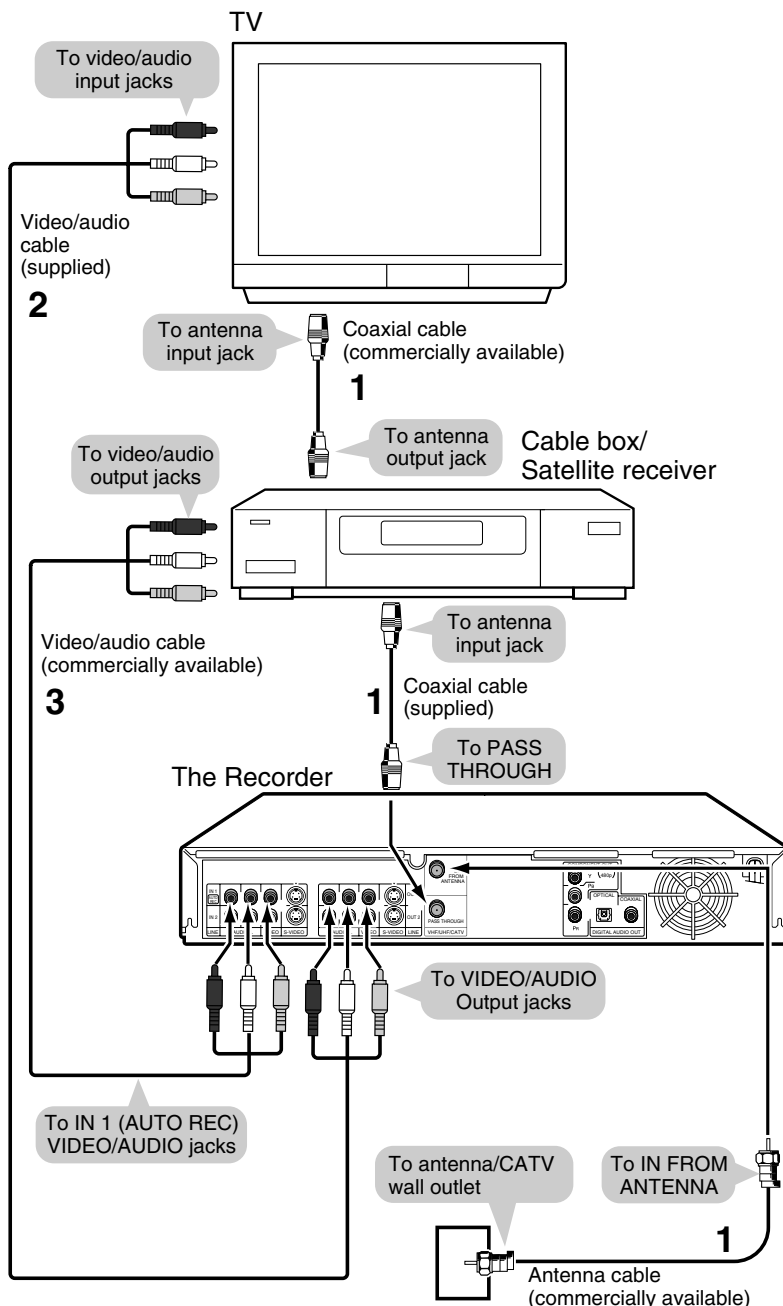

1 Connect the TV antenna/CATV cable and coaxial cables as shown on the left.

You can watch TV channels.

2 Connect the VIDEO/AUDIO Output jacks on this Recorder to the video/audio input jacks on your TV using the supplied video/audio cable.

You can watch video played back on the Recorder.

3 Connect the IN 1 (AUTO REC) VIDEO/AUDIO jacks on this Recorder to the video/audio output jacks on your cable box or satellite receiver using a video/audio cable.

You can record scrambled CATV channels when using a cable box or satellite receiver for decoding.

NOTE

- These are standard video connections. You can use S-video or component connections if they are available.

Important!

- Connect this Recorder directly to your TV and not via the cable box, satellite receiver, or a VCR.
- When using this connection, set "PROGRESSIVE OUT" to "PROGRESSIVE SCAN OFF" (see page 80).

After the connection

Plug in the power cords of the TV and cable box/satellite receiver. Then go to "EZ Set Up" (see page 25).

CATV or Satellite Receiver Connections

Connecting to a Cable Box or Satellite Receiver (2)

The following connection is the connection to a cable box or satellite receiver when many or all the channels received are scrambled.

Using this connection, you can:

- Record any CATV signals by selecting them on the cable box or satellite receiver.
- Record using the "AV AUTO REC" function (see page 44) when LINE IN 1 is used for cable box/satellite receiver connection.

NOTE

- With this connection, you cannot record a channel while you watch another.

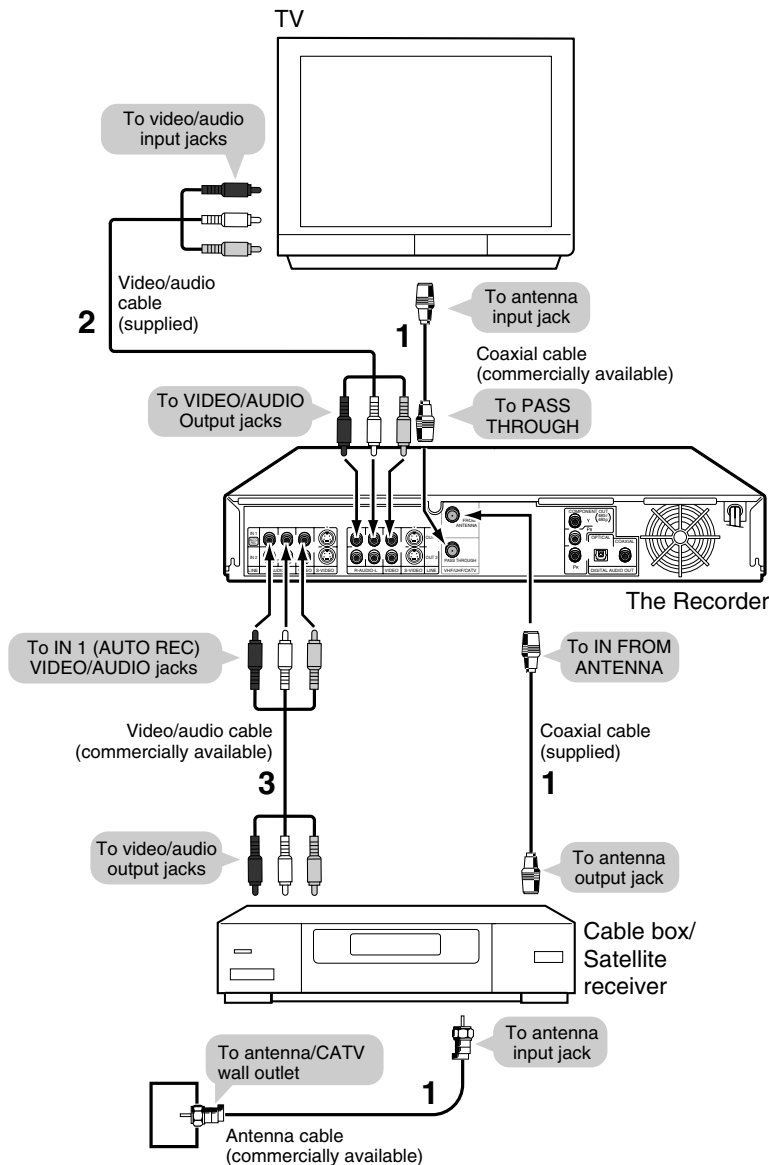

1 Connect the TV antenna/CATV cable and coaxial cables as shown on the left.

You can watch TV channels.

2 Connect the VIDEO/AUDIO Output jacks on this Recorder to the video/audio input jacks on your TV using the supplied video/audio cable.

You can watch video played back on the Recorder.

3 Connect the IN 1 (AUTO REC) VIDEO/AUDIO jacks on this Recorder to the video/audio output jacks on your cable box or satellite receiver using a video/audio cable.

You can record scrambled CATV channels.

NOTE

- These are standard video connections. You can use S-video or component connections if they are available.

Important!

- Connect this Recorder directly to your TV and not via the cable box, satellite receiver, or a VCR.
- When using this connection, set "PROGRESSIVE OUT" to "PROGRESSIVE SCAN OFF" (see page 80).

After the connection

Plug in the power cords of the TV and cable box/satellite receiver. Then go to "EZ Set Up" (see page 25).

EZ Set Up

Important! (Caution during EZ Set Up):

- Do not press **POWER** on the Recorder or remote control.

The EZ Set Up function automatically sets the tuner channels and clock when the antenna cable is connected to the rear of the Recorder and the power plug is then connected to an AC outlet.

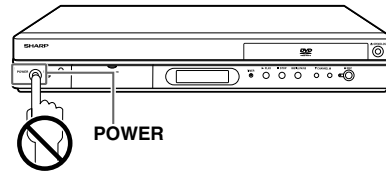

Important!

When using a cable box:

- See "CATV or Satellite Receiver Connections" on pages 23 and 24.
- Leave power on the cable box turned on and select a channel that carries EDS signals.

1 Make sure that the antenna cable is connected. For connection configuration, refer to "Basic Connection" on page 21.

2 Connect the power plug of the Recorder to an AC outlet.

3 The tuner channels and clock will automatically be set.

- This Recorder can monitor and use time-signals (EDS signals), which are provided by some TV stations, to automatically adjust the clock. This Recorder automatically searches EDS signals, but if you are in a hurry to use timer recording or know the channel of the EDS signal carrier in your area, follow the procedure in "Auto Clock Setting" (page 29) or "Manual Clock Setting" (page 30).

During Auto Channel Setting

CH 02

- Channel number is increasing.

During Auto Clock Setting

AUTO

EZ Set Up complete

10:28AM

NOTE

- If power is supplied to the Recorder before the cable is connected, EZ Set Up will not be able to preset the channels into memory. If this occurs, press **RESET** inside the front door of the Recorder (see page 17). The EZ Set Up function will work again.
- If the power is turned on during EZ Set Up, Auto Channel Setting will be interrupted and the tuner channels will not be preset.
- Auto Clock Setting may take several minutes.
- If Auto Clock Setting is not completed within 30 minutes, there may be no channels with EDS signals. In this case, set the clock manually. (See "Manual Clock Setting" on page 30.)
- If the antenna signal is weak, the Auto Clock Setting function may not operate.
- During initial channel setting, the channels are set into the AIR channel setting. To watch CATV channels, select "CATV" on the "CHANNEL PRESET" screen. (See "Channel Setting" on page 31.)

Turning the Power On

After finishing EZ Set Up, press **POWER** on the remote control or Recorder to turn on the power of Recorder.

- When the Recorder power is turned on for the first time after purchase, following EZ Set Up, the OSD LANGUAGE Select screen is displayed and the Connection Guide function will then operate. Follow the procedure shown on pages 26 and 27. From the second time on, the OSD LANGUAGE Select screen will not appear after EZ Set Up.

To Turn the Power Off

Press **POWER** on the remote control or Recorder to turn off power.

- The STANDBY indicator will light up.
- If you press **POWER** again immediately after turning off, the Recorder may not turn on. If this happens, wait a while and then turn on power again.

About the Power Supply

- Do not unplug the power cord immediately after you plug it into the AC outlet (less than about 15 seconds after plugging in). In very rare cases, this may cause the memory to revert to its initial state, and all timer programs will be erased. If this happens, EZ Setup will be performed automatically.

Connection Guide

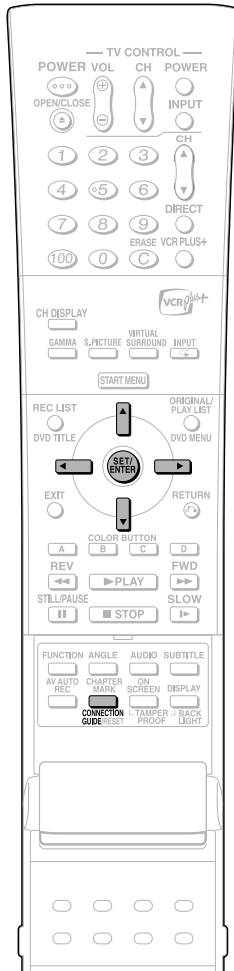

Before using the Recorder, use the Connection Guide function for easy initial settings regarding TV connection, on screen language, etc.

Preparation

- Turn on the power of TV.
- Switch TV input to the AV input used to connect to the Recorder.

- 1 Press and hold **CONNECTION GUIDE** for more than 2 seconds.

Selecting the On-screen Display Language

- 2 Press **▲ / ▼** to select the language you want to use.

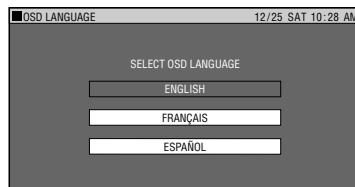

NOTE

- You can change On-Screen Display Language afterward using the Connection Guide function.

- 3 Press **SET/ENTER**.

- The "START TV SET UP" screen with "OK" button is displayed.

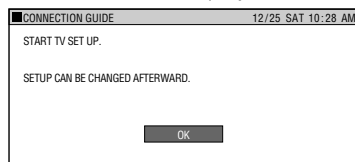

- 4 Press **SET/ENTER**.

- The "SELECT TV TERMINAL" screen is displayed.

NOTE

- Press **RETURN** to go back to the preceding screen during the setting procedure.

Selecting the TV Terminal

- 5 Press **▲ / ▼** to select the type of video input terminal on the connected TV.

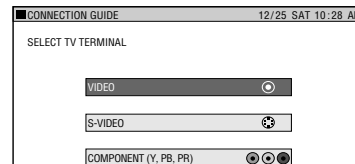

- 6 Press **SET/ENTER**.

- The "SELECT TV MODE" screen is displayed.

Selecting the TV Screen Aspect Ratio

- 7 Press **▲ / ▼** to select the screen aspect ratio of the connected TV.

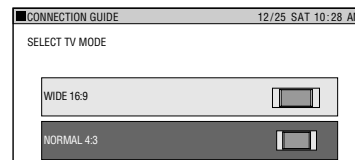

- 8 Press **SET/ENTER**.

- The "ADVANCED SETTINGS" Confirmation screen is displayed.

- 9 Press **◀ / ▶** to select "YES" or "NO", then press **SET/ENTER**.

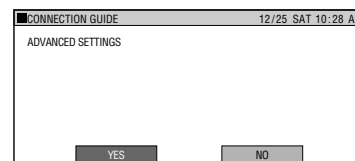

- When "YES" is selected The "ADVANCED SETTINGS" screen is displayed. Proceed to step **10**.
- When "NO" is selected The "INITIAL SETTING COMPLETE" screen with "OK" button is displayed. Proceed to step **17**.

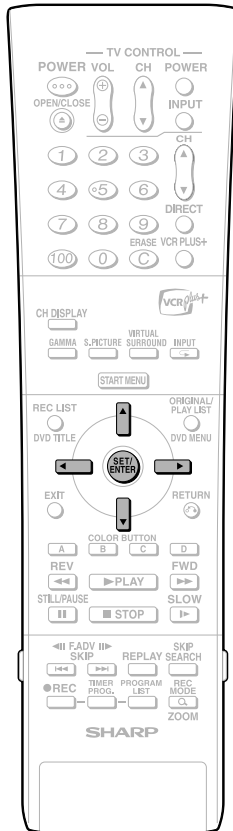

Advanced Setting

10 Press **▲ / ▼** to select “**PROGRESSIVE OUT**”, then press **SET/ENTER**.

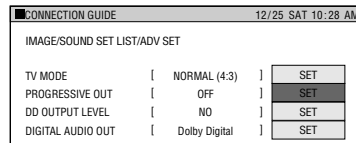

- The “SETS PROGRESSIVE SCAN OUTPUT” screen is displayed.

11 Press **◀ / ▶** to select “**PROGRESSIVE SCAN ON**” or “**PROGRESSIVE SCAN OFF**”, then press **SET/ENTER**.

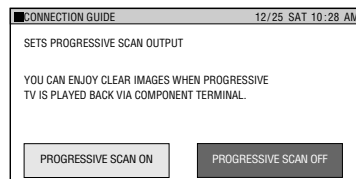

- The display returns to the “IMAGE/SOUND SET LIST/ADV SET” screen.

12 Press **▲ / ▼** to select “**DD OUTPUT LEVEL**”, then press **SET/ENTER**.

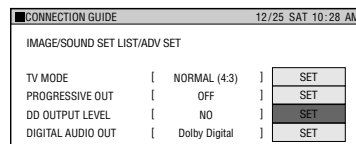

- The “Dolby Digital OUTPUT LEVEL SETTING” screen is displayed.

13 Press **◀ / ▶** to select “**NO**” or “**YES**”, then press **SET/ENTER**.

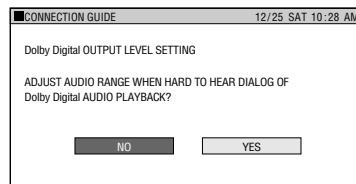

- The display returns to the “IMAGE/SOUND SET LIST/ADV SET” screen.

14 Press **▲ / ▼** to select “**DIGITAL AUDIO OUT**”, then press **SET/ENTER**.

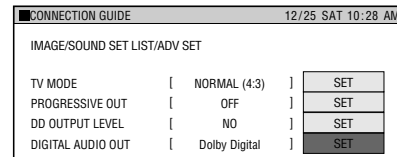

- The “DIGITAL AUDIO OUT” setting screen is displayed.

15 Press **▲ / ▼** to select “**PCM**” or “**Dolby Digital**”, then press **SET/ENTER**.

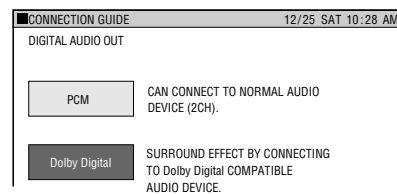

- The display returns to the “IMAGE/SOUND SET LIST/ADV SET” screen.

16 Press **▲ / ▼** to select “**ADVANCED SET COMPLETE**”, then press **SET/ENTER**.

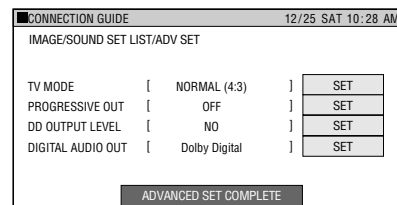

- The “INITIAL SETTING COMPLETE” screen with “OK” button is displayed.
- For details of Function setting, see pages **80** and **81**.

NOTE

- Press **RETURN** to go back to the preceding screen during the setting procedure.

Completing the Initial Setting

17 Press **SET/ENTER** to end the initial setting procedure.

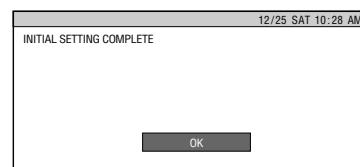

About START MENU

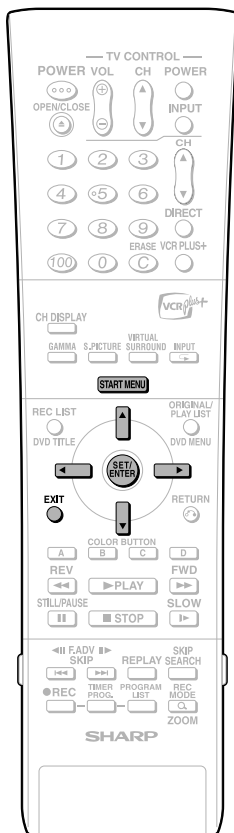

About START MENU

With this Recorder, you can call up functions like Playback, Edit and Other Settings from the START MENU.

For details on operation procedures, see the page explaining each option.

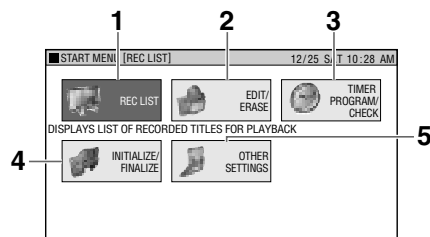

1 REC LIST

Playing back with REC LIST... page 47
Calling up various functions... page 48

2 EDIT/ERASE

Editing with the Original Title List/
Play List... page 60
Erasing all recorded titles... page 67
Erasing selected titles... page 67
Protecting titles from erasure... page 66

3 TIMER PROGRAM/CHECK

Programming with Easy Recording
Guide... page 37
Timer recording with VCR Plus+®... page 39
Timer recording by designating date and
time... page 41
Checking/Changing timer settings... page 43

4 INITIALIZE/FINALIZE

Initialization... page 84
Finalization... page 84

5 OTHER SETTINGS

Recording function settings... page 76
Viewing/Play setting... page 78
Adjustment... page 80

Basic START MENU Operation

1 Press **START MENU** to display the START MENU.

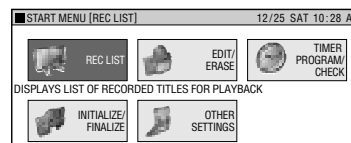

2 Press **▲/▼/◀/▶** to select an option.

Example: When "OTHER SETTINGS" is selected

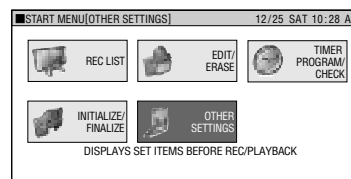

3 Press **SET/ENTER** to enter the selected option.

- The screen for the selected option will appear.
- Operate using **▲/▼/◀/▶** and **SET/ENTER**.

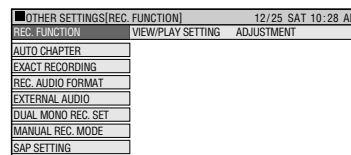

4 Press **START MENU** or **EXIT** to quit the START MENU.

- The "START MENU" screen will close, and the screen will return to normal.

NOTE

- If you perform no operation, the "START MENU" screen will disappear after about 1 minute.
- **This operation will not work at the following times:**
During playback, during display of the REC LIST, and at the erase screen.
- If you make a mistake in operation and want to start over, press **RETURN** to go back to the preceding screen.

Clock Setting

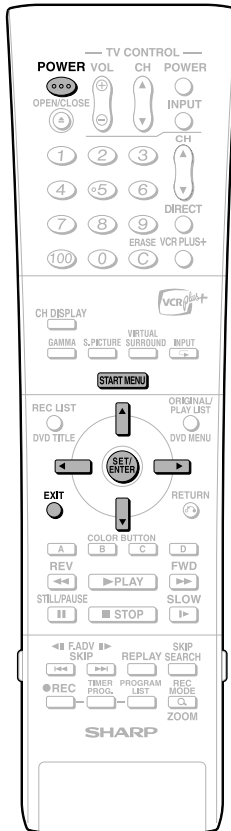

Auto Clock Setting

(If you know a channel that carries EDS signals)

! Important!

When using a cable box:

- See "CATV or Satellite Receiver Connections" on pages 23 and 24.
- Leave power on the cable box turned on and select a channel that carries EDS signals.

1 Press **START MENU** to display the **START MENU** screen.

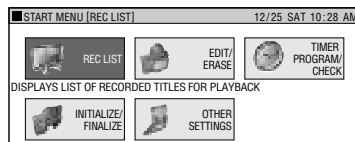

2 Press **▲/▼/◀/▶** to select "**OTHER SETTINGS**", then press **SET/ENTER**.

3 Press **◀/▶** to select "**ADJUSTMENT**".

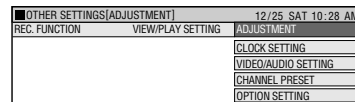

4 Press **▲/▼** to select "**CLOCK SETTING**", then press **SET/ENTER**.

5 Press **▲/▼** to select "**AUTO SETTING**", then press **SET/ENTER**.

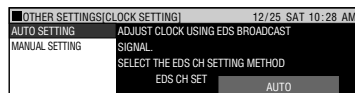

6 Press **▲/▼** to set **EDS CH SET** mode to "**MANUAL**".

- If you do not know which channel carries EDS signals, then select "AUTO".

7 Press **◀/▶** to select a channel that carries EDS signals.

- The number of channels that can be selected depends on the mode setting on the "CHANNEL PRESET" screen. See **NOTE**.

When using a cable box:

- Input the output channel (02, 03, or 04) of the cable box.

8 Press **SET/ENTER** to select "**TIME ZONE**".

9 Press **◀/▶** to select the desired time zone.

- If you want the Recorder to use the time zone from which broadcasts with EDS signals are received, choose "AUTO". If broadcasts with EDS signals are received from a different time zone than the one in which you live, be sure to select your time zone.

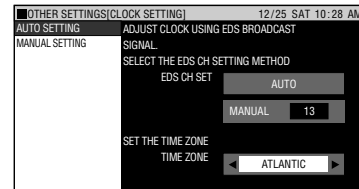

10 Press **SET/ENTER**, then **EXIT**.

11 Press **POWER** to turn off the Recorder.

- The Auto Clock Setting function will automatically set the clock.

NOTE

- If the "EDS CH SET" mode is set to "MANUAL" in step 6 and a channel that does not carry EDS signals is selected in step 7, the Auto Clock Setting function will not operate.
- In step 7, the number of selectable channels depends on the mode setting on the "CHANNEL PRESET" screen. See the table below.

| AIR/CATV | Selectable channels |
|----------|-----------------------------------|
| AIR | 02 ↔ 03 ↔ 04 68 ↔ 69 ↔ 02 |
| CATV | 01 ↔ 02 ↔ 03 124 ↔ 125 ↔ 01 |

- As you press **◀/▶** in step 9, the TIME ZONE choices change as follows.

AUTO ↔ ATLANTIC ↔ EASTERN ↔ CENTRAL
HAWAII ↔ ALASKA ↔ PACIFIC ↔ MOUNTAIN

- If you press **RETURN**, **START MENU** or **EXIT** before pressing **SET/ENTER** in step 10, the data will not be stored.

Clock Setting

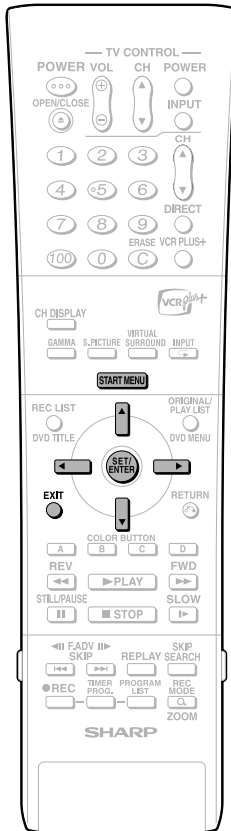

Manual Clock Setting

- 1** Press **START MENU** to display the **START MENU** screen.
 - 2** Press **▲/▼/◀/▶** to select **“OTHER SETTINGS”**, then press **SET/ENTER**.
 - 3** Press **◀/▶** to select **“ADJUSTMENT”**.
 - 4** Press **▲/▼** to select **“CLOCK SETTING”**, then press **SET/ENTER**.
 - 5** Press **▲/▼** to select **“MANUAL SETTING”**, then press **SET/ENTER**.
-
- 6** Press **◀/▶** to select **“TIME”** and press **▲/▼** to set time.
 - 7** Select and set **“DATE”**, **“YEAR”** and **“DST”** in the same manner as in step 6.
 - See “Automatic Daylight Saving-Time (DST) Adjustment”.

Example: Dec. 25, 2004, DST: ON

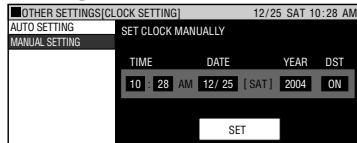

- 8** If the data is correct, press **▶** to select **“SET”**, then press **SET/ENTER** to complete clock setting. Press **EXIT** to return to normal screen.
 - The screen returns to normal.

NOTE

- If you press **RETURN**, **START MENU** or **EXIT** before pressing **SET/ENTER** in step 8, the data will not be stored.

Automatic Daylight Saving-Time (DST) Adjustment

This Recorder is equipped with an internal Automatic Daylight Saving-Time Adjustment function. In spring (first Sunday in April) and autumn (last Sunday in October), the time is adjusted as shown below. This function has been preset to “ON” at the factory. Set the DST mode in the “CLOCK SETTING” screen.

Spring

Programmed timer recording set within this time frame (2:00 AM to 3:00 AM) will not be carried out.

First Sunday in April (DST is ON)

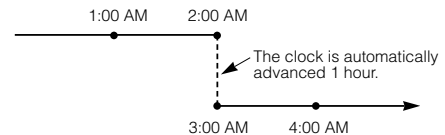

Autumn

Because there will be two time frames from 1:00 AM to 2:00 AM, a timer program set between these time frames will be influenced by the time change.

Last Sunday in October (DST is ON)

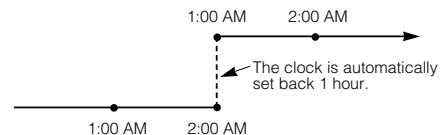

NOTE

- If the timer recording program is affected by the DST time change, check your TV listing and find out when it reflects the time change. Some TV listings will indicate the time change in the same manner as is programmed in this Recorder while others do not show the time change until the next morning. In that case, when programming a timer recording, use the “CLOCK SETTING” screen to set the DST mode to OFF so the time change will not be carried out.

Channel Setting

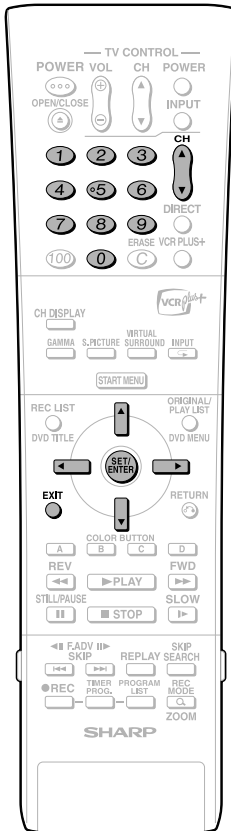

Channel Setting

This Recorder can receive a maximum of 181 channels as shown below by presetting the channels into memory.
(VHF: 2 to 13, UHF: 14 to 69, CATV: 1 to 125)

- 1** Press **START MENU** to display the **START MENU** screen.
- 2** Press **▲/▼/◀/▶** to select “**OTHER SETTINGS**”, then press **SET/ENTER**.
- 3** Press **◀/▶** to select “**ADJUSTMENT**”.
- 4** Press **▲/▼** to select “**CHANNEL PRESET**”, then press **SET/ENTER**.
- 5** Press **◀/▶** to select “**AIR**” or “**CATV**”, then press **SET/ENTER**.
- 6** Press **◀/▶** to select “**AUTO**”, then press **SET/ENTER**.

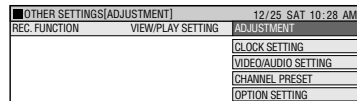

Example: AIR

- To watch CATV after EZ Set Up, select “CATV”, then press **SET/ENTER**.

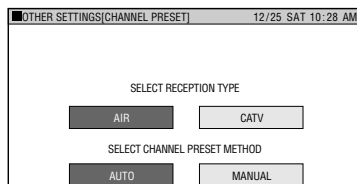

- 7** Auto Channel Preset will start.
 - The channel display will count up, and, when finished, the screen returns to normal.

NOTE

- If the power is interrupted for more than 1 hour, AIR/CATV selection must be set again.
- Auto Channel Preset will be interrupted if **START MENU** is pressed before the screen returns to normal.

Adding/Erasing Channel Memory

Use this function to manually add or erase channels to/from the memory.

- 1** Select the channel to be added with the **Number** buttons, or the channel to be erased with the **CH ▲/▼** or **Number** buttons.
- 2** Press **START MENU** to display the **START MENU** screen.
- 3** Press **▲/▼/◀/▶** to select “**OTHER SETTINGS**”, then press **SET/ENTER**.
- 4** Press **◀/▶** to select “**ADJUSTMENT**”.
- 5** Press **▲/▼** to select “**CHANNEL PRESET**”, then press **SET/ENTER**.
- 6** Press **▲/▼/◀/▶** to select “**MANUAL**”, then press **SET/ENTER**.

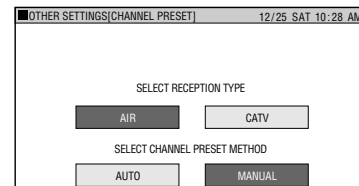

- 7** Press **◀/▶** to select “**ADD**” if you want to add the channel memory, or “**ERASE**” if you want to erase the channel memory.

[ADD]

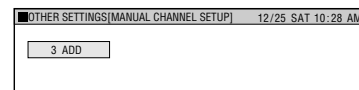

[ERASE]

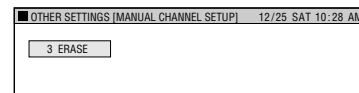

- 8** Press **EXIT** to return to normal screen.

Display Information

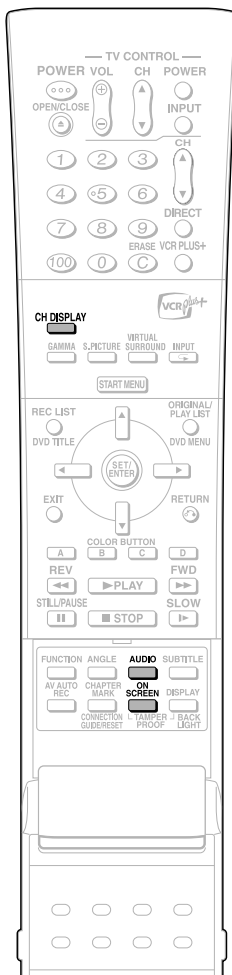

Content of TV Screen Display

When the power is turned on or the channel is switched.

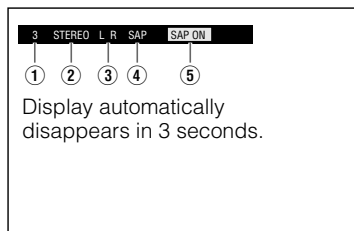

- ① Channel currently selected
- ② Audio type
Stereo: STEREO
- ③ Audio selected by **AUDIO** button
- ④ SAP signal reception
- ⑤ SAP mode display

Monitor Output when Receiving a Stereo or SAP Broadcast

When receiving a stereo or SAP broadcast, press **AUDIO** to change the audio output mode to select Monitor Output. See the table of SAP on page 77 for details.

NOTE

- When the signal is weak (hard to hear) in a stereo broadcast, press **AUDIO** to turn off "L R" display on the TV screen and change the audio output mode to MONO.

Checking the Channel

- 1 Press **CH DISPLAY** while viewing a live program (DVD stopping) or recording (DVD recording).
 - Channel information is displayed.

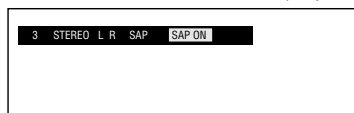

- Each time you press **CH DISPLAY**, the channel information display is turned on/off.
- The channel information display will automatically turn off in 1 minute.

Checking Remaining Time of DVD and Number of Titles

- 1 Press **ON SCREEN** (under the cover).

- The DVD information screen is displayed.

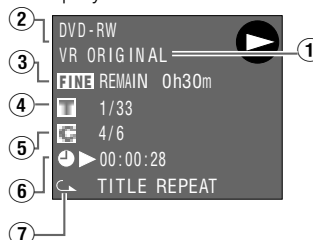

- ① Disc type, recording format, original title playback/Play List playback indicators
- ② Mode display
 - Playback:
 - Recording:
 - Stop:
- ③ Recording mode and remaining (recordable) time
 - "FINALIZED" indicator when a finalized disc is played back.
- ④ Current title number/Total number of titles
 - Total number of titles (Stop mode)
 - Title number currently played back (Playback mode)
 - Title number currently recorded (Recording mode)
- ⑤ Current chapter number/Total number of chapters
 - Total number of chapters (Stop mode)
 - Chapter number currently played back (Playback mode)
 - Chapter number currently recorded (Recording mode)
- ⑥ Counter
- ⑦ Repeat Playback indicator

- 2 Press **ON SCREEN** (under the cover) again.

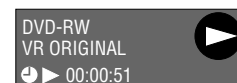

- The screen changes to the counter display.

- 3 Press **ON SCREEN** (under the cover) again.

- Display is turned off.

NOTE

- The DVD information screen (step 1) will automatically disappear in 1 minute.
- The counter display (step 2) will not disappear automatically. Press **ON SCREEN** (under the cover) to turn it off.

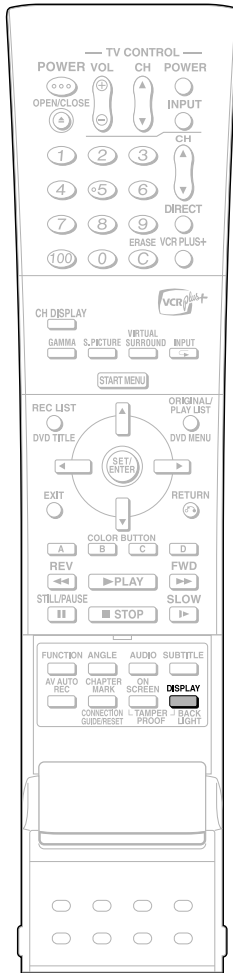

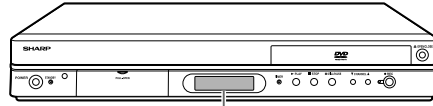

Switching Front Panel Display

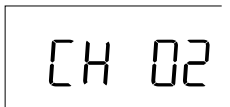
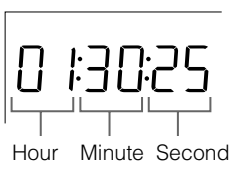

Front panel display

- 1 Turn the power on.**

 - Channel display (when watching TV)
 - Counter display (during playback/recording)
- 2 Press DISPLAY (under the cover).**

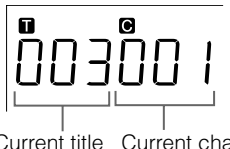
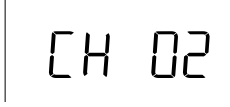
 - Remaining time display (when watching TV)
 - Current title number and chapter number (during playback)
 - Channel currently recorded (during recording)
- 3 Press DISPLAY (under the cover) again.**

 - The screen returns to the display in step 1.

Recording to DVD

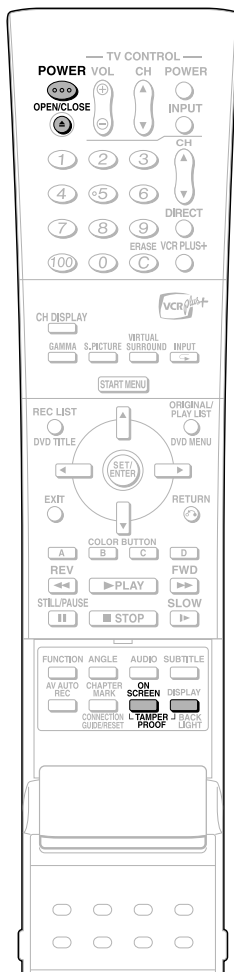

Checking Remaining Time and Other Information

Press **ON SCREEN** (under the cover) during DVD playback or recording.

- Disc capacity and the number of recorded titles, etc. are displayed. It is recommended to confirm before recording.

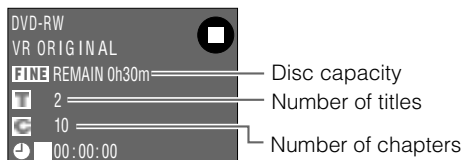

- "REMAINING 0h0m" will be displayed when an unrecordable disc is set.

NOTE

- Disc remaining time display is approximate measure of disc capacity. There may be space left in disc capacity after recording. (Remaining time during recording and after recording might not be the same.)

Not Enough Disc Capacity

- **Exact Recording (page 76)**
Exact recording functions when the selected recording mode is not appropriate to fit the program to the disc when you timer record.

Cutting TV Commercials (page 60)

- You cannot cut scenes when you record programs by Video mode to DVD-RW or DVD-R.

Tamper Proof

- You can set Tamper Proof to prevent operations by mistake during recording or timer recording.
 - ① Press and hold **TAMPER PROOF (ON SCREEN and DISPLAY)** together for more than 2 seconds.
 - ② Each time you perform this operation, the function is activated or deactivated.
- If you try to operate the Recorder while Tamper Proof is set, "Ⓞ" blinks in the front display panel and tells you that Tamper Proof is set.

Loading Disc

- 1 Press **POWER** to turn the power on.
- 2 Press **OPEN/CLOSE** on the Recorder to open the disc tray.



- 3 Load disc on the disc tray.



- Insert the disc with the label face up.
- In case of disc recorded on both sides, face the side you want to record down.

- 4 Press **OPEN/CLOSE** to close the disc tray.

Direct Recording to DVD



Explained below is the standard procedure for recording the program being viewed onto DVD.

- You can create a maximum of 99 original titles.
- Record in VR mode when you want to edit later. Edit functions will be limited when you record in Video mode.

Preparation for Direct Recording

- When you record SAP broadcast, set "SAP SETTING" to "ON" (see page 76).

- 1 ① **Turn on the power of TV.**
 - When the recorder is connected to other audio equipment, turn them on as well.
- 2 ② **Set the TV input mode to the mode the recorder is set to.**
- 2 Press **POWER** to turn on the recorder.
- 3 **Set a DVD-RW or DVD-R disc.**
 - When a new DVD-RW disc not initialized yet is set, VR mode initializing starts automatically. When initializing is over, you can start recording.
 - When you want to re-initialize in Video mode, select "VIDEO MODE INIT." screen (page 84).
 - When you want to initialize in Video mode from the beginning, select "AUTO INITIALIZE" screen (page 84).

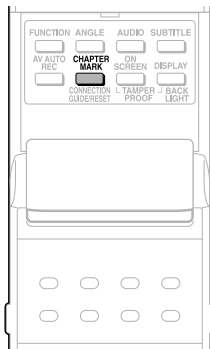
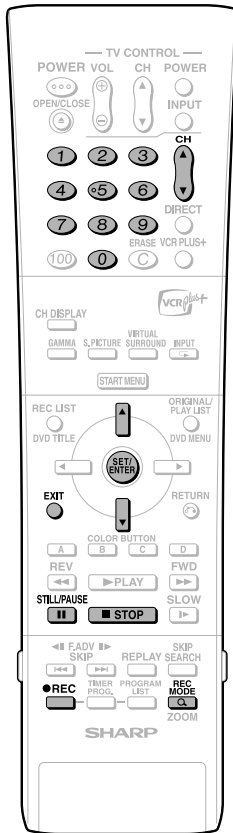

4 Press Number buttons or CHANNEL ▲/▼ to select the channel to record.

5 Press REC MODE to select the desired recording mode.

- The recording mode changes as shown below each time the button is pressed.

→ FINE → SP → LP → EP → MN × ×

- Recording mode set when "MN × ×" is selected is the recording mode set on the "MANUAL REC. MODE" Select screen (page 36).

6 Press ● REC.

- Recording begins and REC icon is displayed.
- The REC indicator on the front of the Recorder is lit red during recording.

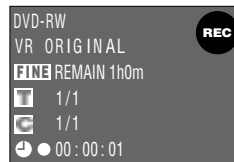

7 Press || STILL/PAUSE to pause recording.

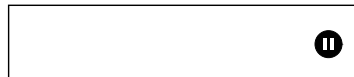

- Pause will not function during timer recording.
- The REC indicator on the front of the Recorder blinks during Recording Pause mode.

8 Press || STILL/PAUSE to resume recording.

9 Press ■ STOP to stop recording.

- "DATA IS BEING RECORDED TO DISC." displays on TV screen and recording stops.



- Stop recording first when you take out the disc.

NOTE

- Press **ON SCREEN** (under the cover) to confirm remaining time of DVD or check the counter display during recording.
- You cannot record programs which prohibit recording.
- Recording either stops or pauses automatically in the following cases.
 - Program which prohibits recording is on air.
 - Unable to continue recording for some reason.

- Timer recording cannot be performed during direct recording. To perform timer recording, stop direct recording before the preset start time for timer recording.

You may not be able to record on disc edited by other recorder.

- If a disc edited by other DVD recorder has more than 999 chapter marks, it cannot be edited (or recorded) with this Recorder.
- If a disc edited by other DVD recorder has added or erased scenes 51 times or more per title or the disc is protected, it cannot be edited (or recorded) with this Recorder.

About Recording to DVD in Video Mode

- In case you are recording to DVD in Video mode and recording stops due to power failure etc., recorded contents a few minutes before the stop may not be recorded.

Inserting Chapter Marks Manually during Recording

Press **CHAPTER MARK** (under the cover).

- "RECORDED CHAPTER MARK." displays and chapter mark is recorded.
- You can only record chapter marks manually when recording to DVD-RW (VR mode).
- You cannot record chapter marks manually when recording to DVD-RW (Video mode) or DVD-R.

Setting the Record End Time during Direct Recording (Simple Recording Timer)

DVD-RW | DVD-RW | DVD-R
VR MODE | VIDEO MODE

1 Press ● REC on the remote control during recording.

- The Record End Time Setting screen is displayed.

2 Press ▲/▼ to set the end time.

- The end time can be set in units of 15 minutes.
- Total recording time cannot exceed 6 hours so the end time has to be set accordingly.
- Press **EXIT** to stop setting midway through.

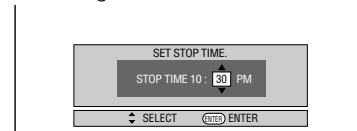

3 Press SET/ENTER.

- The record end time is set, and the clock mark lights up on the front display panel.

Setting Recording Mode

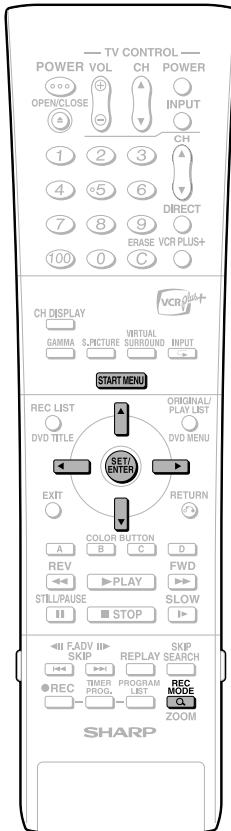

DVD-RW/R Recording Mode and Recording Time

| DVD-RW VR MODE | | DVD-RW VIDEO MODE | | DVD-R | |
|-------------------|--------------------------|----------------------|--------------------------|----------------|--------------------------|
| Recording Mode | Recording Time (approx.) | Recording Mode | Recording Time (approx.) | Recording Mode | Recording Time (approx.) |
| MN1 | 360 Min | EP | MN1 | 360 Min | |
| MN2 | 345 Min | | MN2 | 345 Min | |
| MN3 | 330 Min | | MN3 | 330 Min | |
| MN4 | 315 Min | | MN4 | 315 Min | |
| MN5 | 300 Min | | MN5 | 300 Min | |
| MN6 | 285 Min | | MN6 | 285 Min | |
| MN7 | 270 Min | | MN7 | 270 Min | |
| MN8 | 255 Min | | MN8 | 255 Min | |
| MN9 | 240 Min | LP | MN9 | 240 Min | |
| MN10 | 230 Min | | MN10 | 230 Min | |
| MN11 | 220 Min | | MN11 | 220 Min | |
| MN12 | 210 Min | | MN12 | 210 Min | |
| MN13 | 200 Min | | MN13 | 200 Min | |
| MN14 | 190 Min | | MN14 | 190 Min | |
| MN15 | 180 Min | | MN15 | 180 Min | |
| MN16 | 170 Min | | MN16 | 170 Min | |
| MN17 | 160 Min | | MN17 | 160 Min | |
| MN18 | 150 Min | | MN18 | 150 Min | |
| MN19 | 140 Min | | MN19 | 140 Min | |
| MN20 | 130 Min | | MN20 | 130 Min | |
| MN21 | 120 Min | SP | MN21 | 120 Min | |
| MN22 | 110 Min | | MN22 | 110 Min | |
| MN23 | 105 Min | | MN23 | 105 Min | |
| MN24 | 100 Min | | MN24 | 100 Min | |
| MN25 | 95 Min | | MN25 | 95 Min | |
| MN26 | 90 Min | | MN26 | 90 Min | |
| MN27 | 85 Min | | MN27 | 85 Min | |
| MN28 | 80 Min | | MN28 | 80 Min | |
| MN29 | 75 Min | | MN29 | 75 Min | |
| MN30 | 70 Min | | MN30 | 70 Min | |
| MN31 | 65 Min | | MN31 | 65 Min | |
| MN32 | 60 Min | FINE | MN32 | 60 Min | |

- DVD recording time is approximate measure using 4.7GB disc.
- This does not guarantee the length of recording time. Actual recording time may be shorter than that indicated above depending on image quality and other aspects.

NOTE

- Higher recording mode means higher picture quality and lower recording mode means longer recording time.
- Picture quality of recorded content changes distinctively if the recording mode changes from the recording modes right below the bold lines in left chart and recording modes right above the bold lines. The positions of the bold lines differ between DVD-RW (VR Mode) and DVD-RW/R (Video Mode).
- With MN22-32, VBR recording has a large effect, so the actual recording time will be longer.

Setting the Manual Recording Mode (MN)

| DVD-RW VR MODE | DVD-RW VIDEO MODE | DVD-R |
|-------------------|----------------------|-------|
|-------------------|----------------------|-------|

You can set the manual recording mode which is used when you select "MNXX" with **REC MODE**.

- 1 Press **START MENU** to display the **START MENU** screen.



- 2 Press **▲/▼/◀/▶** to select "OTHER SETTINGS", then press **SET/ENTER**.

- 3 Press **◀/▶** to select "REC. FUNCTION".

- 4 Press **▲/▼** to select "MANUAL REC. MODE", then press **SET/ENTER**.

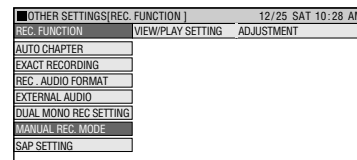

- 5 Press **◀/▶** to select the desired recording mode, then press **SET/ENTER**.

- Refer to table on left column.

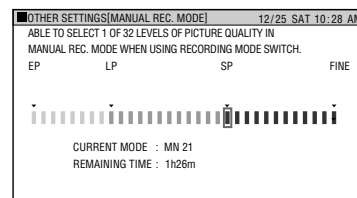

NOTE

When playing back a DVD-RW/R disc (Video Mode) recorded with the recorder using a DVD player.

- When you play back a disc recorded with the manual mode of the recorder using a DVD player, it may not be able to play back depending on the model (some particular modes cannot be played back).

Timer Recording

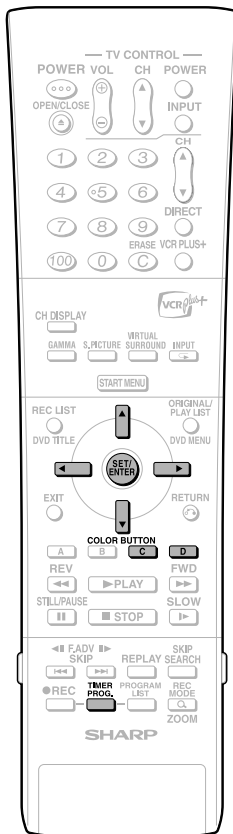

Easy Recording Guide

DVD-RW **DVD-RW** **DVD-R**
VR MODE VIDEO MODE

- This lets you set the timer recording schedule for the next 7 days simply by filling in the pertinent blocks in the on-screen time schedule.
- You can set timer recording for up to a maximum of 8 programs. (This includes VCR Plus+ and Timer Recording.)

Preparation to Use Easy Recording Guide

- 1 Check that the clock is displaying the correct time.
- 2 Preset the channels.
- 3 When you record SAP broadcast, set "SAP SETTING" to "ON" (see page 76).
- 4 When recording from an external equipment such as a CATV box or satellite receiver, turn on the power of the external equipment.

! Important!

- When setting the timer recording, make sure recordable disc is loaded.

1 Press **TIMER PROG.** to display the **TIMER PROGRAM/CHECK** screen.

- You can select the recording method on this screen.
- You can also start timer recording by selecting "TIMER PROGRAM/CHECK" in the START MENU.

2 Press **▲ / ▼** to select "**EASY REC. GUIDE**", then press **SET/ENTER**.

- The "EASY REC. GUIDE" screen (time schedule) is displayed.

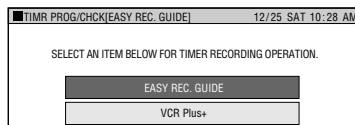

| EASY REC. GUIDE | | | | | | | 12/25 SAT 10:28 AM | | |
|-----------------|---------|--------|--------|--------|--------|--------|--------------------|---|--|
| TODAY | 26 SUN | 27 MON | 28 TUE | 29 WED | 30 THU | 31 FRI | 1 SAT | | |
| CHANNEL | ◀ 10 AM | | | | | | | ▶ | |
| 10 | | | | | | | | | |
| 20 | | | | | | | | | |
| 30 | | | | | | | | | |
| 33 | | | | 45 | | | | | |

- If you press **Yellow (D)** (TIMER LIST), you can check and change timer settings which have already been made. To make a change, choose the timer program you want to change with **▲ / ▼** and press **SET/ENTER**, and then perform step 3 (page 41) to step 13 (page 42).

To set a timer program for a day other than the current day (within a week)

- 1 Press **Green (C)** (DATE/TIME Select).
- 2 Press **◀ / ▶** to select the date.
 - If you select a date and press **SET/ENTER**, only date will be set, and previous screen appears.
- 3 Press **Yellow (D)** (TIME), then press **◀ / ▶** to select the time, and press **SET/ENTER**.
 - Proceed to step 3.

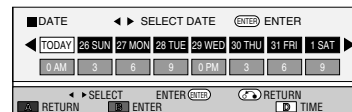

3 Press **▲ / ▼** to select the channel.

| EASY REC. GUIDE | | | | | | | 12/25 SAT 10:28 AM | | |
|-----------------|---------|--------|--------|--------|--------|--------|--------------------|---|--|
| TODAY | 26 SUN | 27 MON | 28 TUE | 29 WED | 30 THU | 31 FRI | 1 SAT | | |
| CHANNEL | ◀ 10 AM | | | | | | | ▶ | |
| 10 | | | | | | | | | |
| 20 | | | | | | | | | |
| 30 | | | | | | | | | |
| 33 | | | | 45 | | | | | |
| 40 | | | | | | | | | |
| 50 | | | | | | | | | |
| 60 | | | | | | | | | |

- The channel can be selected as follows.

TV channels ↔ LINE IN 1 (EXT.1) ↔
LINE IN 3 (EXT.3) ↔ LINE IN 2 (EXT.2) ↔

4 Press **◀ / ▶** to select the start time, then press **SET/ENTER**.

- The start time can be selected in 15 minute units. If the desired 15 minute time frame will start within 3 minutes, that time frame cannot be selected.

Example: If you select 10:30 at 10:28, the start time will switch to 10:45.

| EASY REC. GUIDE | | | | | | | 12/25 SAT 10:28 AM | | |
|-----------------|---------|--------|--------|--------|--------|--------|--------------------|---|--|
| TODAY | 26 SUN | 27 MON | 28 TUE | 29 WED | 30 THU | 31 FRI | 1 SAT | | |
| CHANNEL | ◀ 10 AM | | | | | | | ▶ | |
| 10 | | | | | | | | | |
| 20 | | | | | | | | | |
| 30 | | | | | | | | | |
| 33 | | | | 45 | | | | | |
| 40 | | | | | | | | | |
| 50 | | | | | | | | | |
| 60 | | | | | | | | | |

- You cannot select a time frame which is already scheduled.

5 Press **◀ / ▶** to select the stop time, then press **SET/ENTER**.

- The stop time can be set in 15 minute units (up to a maximum of 6 hours in the future).

| EASY REC. GUIDE | | | | | | | 12/25 SAT 10:28 AM | | |
|-----------------|---------|--------|--------|--------|--------|--------|--------------------|---|--|
| TODAY | 26 SUN | 27 MON | 28 TUE | 29 WED | 30 THU | 31 FRI | 1 SAT | | |
| CHANNEL | ◀ 10 AM | | | | | | | ▶ | |
| 10 | | | | | | | | | |
| 20 | | | | | | | | | |
| 30 | | | | | | | | | |
| 33 | | | | 45 | 30 | | | | |
| 40 | | | | | | | | | |
| 50 | | | | | | | | | |
| 60 | | | | | | | | | |

Continued on Next Page ▶▶▶

Timer Recording

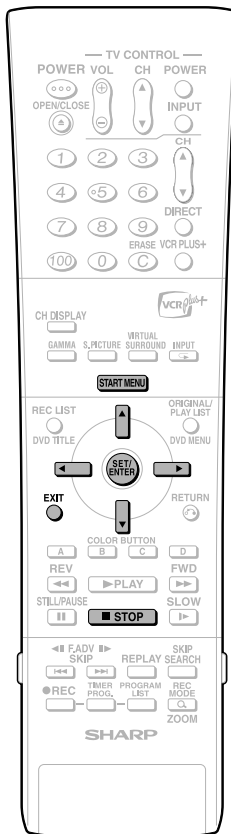

6 Press ◀/▶ to select “REC. MODE”, then press SET/ENTER.

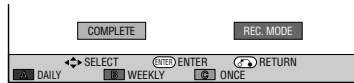

- Press ◀/▶ to select the item you want to correct such as the start/stop time, then press ▲/▼ to correct. (For details refer to page 40.)
- If you complete timer recording setting less than 3 minutes before it starts, timer recording start time column will stay as selected. Reset the timer recording start time at least 3 minutes after the present time.

7 Press ▲/▼ to select the recording mode, then press SET/ENTER.

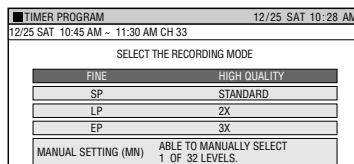

- If there is not enough empty space (time), a message is displayed. Select the recording mode again.

When “MANUAL SETTING (MN)” is selected:

- Select the recording mode with ◀/▶, then press SET/ENTER. (The recording mode can be selected from 32 levels.)

8 Confirm the setting of timer program, press ◀ to select “COMPLETE”, then press SET/ENTER.



- “TIMER PROGRAM LIST” screen is displayed.
- The TIMER indicator on the front of the Recorder lights up and timer programming is completed.

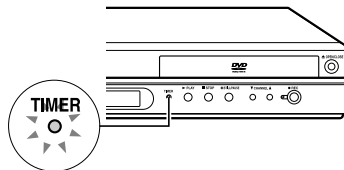

9 Confirm the programs on the list and then press SET/ENTER.

- The “TIMER PROGRAM/CHECK” screen is displayed. If you continue timer programming using Easy Recording Guide, repeat from step 2.

10 Press START MENU or EXIT to complete EASY REC. GUIDE timer setting.

- Timer recording will function even after you turn the power off.

NOTE

- Timer recording will not start during disc playback.
- When the power is off while recording timer is set, front display panel will light up once timer recording starts. If you want to turn off the light, set “LCD BACKLIGHT REC.” (page 82) to “YES”.

You can also turn off the light by pressing **BACK LIGHT** on the remote control (under the cover) for more than 2 seconds.

Convenient Functions When Recording Exact Recording (page 76)

- If you set EXACT RECORDING to “YES”, the Recorder will automatically adjust the recording mode of timer recording so the recorded programs will fit into one disc.

To check, change or cancel timer settings

- See page 43.

To stop recording while timer recording is in progress

- If you press ■STOP, “TIMER RECORDING IS IN PROGRESS. IF YOU PRESS THE STOP BUTTON ONCE MORE, TIMER RECORDING CANCELS AND RECORDING STOPS.” will appear on the screen. Even that message goes out of the screen, pressing ■STOP one more time will stop the recording.

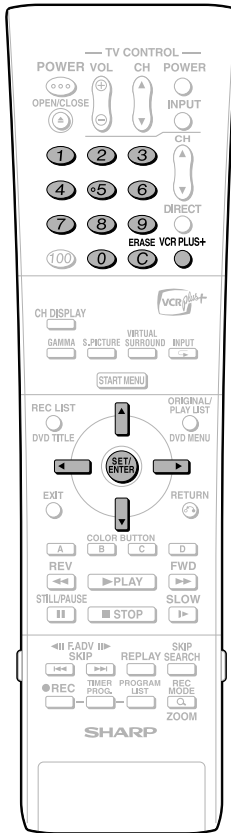

Timer Recording with VCR Plus+® System

DVD-RW VR MODE DVD-RW VIDEO MODE DVD-R

- The VCR Plus+® System allows you to program your Recorder for timer recording simply by inputting the PlusCode number.
- The PlusCode numbers are listed in most newspapers, television guides, and local CATV listings. Simply by inputting this PlusCode number, you can program your Recorder for timer recording, eliminating the need to input program start time, stop time, channel, date and other information usually necessary for timer recording.
- Up to 8 timer programs can be stored. (This includes Easy Recording Guide and Timer Program.)

Preparation to Use VCR Plus+ System

- 1 Check that the clock is displaying the correct time.
- 2 Preset the channels.
- 3 When you record SAP broadcast, set "SAP SETTING" to "ON" (see page 76).
- 4 When recording from an external equipment such as a CATV box or satellite receiver, turn on the power of the external equipment.

! Important!

- When setting the timer recording, make sure recordable disc is loaded.

1 Press VCR PLUS+ (button) to display the VCR Plus+ Setting screen.

- If you press VCR PLUS+ (button) when the clock has not been set, the "CLOCK SETTING" screen will appear.

2 Press Number buttons to enter the PlusCode number.

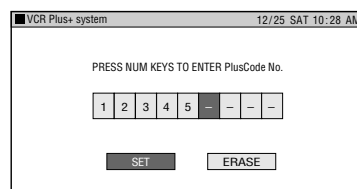

- Press ERASE if you make a mistake in the Plus Code number. Or Press ◀/▶ to select "ERASE", then press SET/ENTER. Each time you press the button, one digit will be erased.
- Press VCR PLUS+ (button) to cancel the entire number.

3 Press ◀/▶ to select "SET", then press SET/ENTER.

- The timer recording details such as date, start time, end time and channel will be displayed.

4 Press ◀/▶ to select "REC. MODE", then press SET/ENTER.

- When recording a program on a channel for the first time, be sure to enter the correct channel number in this step, otherwise the PlusCode number will not be successfully decoded.

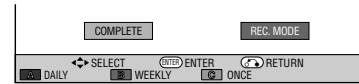

- Press ◀/▶ to select the item you want to correct such as the start/stop time, then press ▲/▼ to correct. (For details refer to page 40.)
- If you complete timer recording setting less than 3 minutes before it starts, timer recording start time column will stay as selected. Reset the timer recording start time at least 3 minutes after the present time.

5 Press ▲/▼ to select the recording mode, then press SET/ENTER.

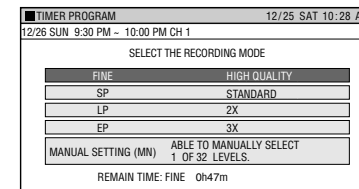

- If there is not enough empty space (time), a message is displayed. Select the recording mode again.

When "MANUAL SETTING (MN)" is selected:

- Select recording mode with ◀/▶, then press SET/ENTER. (The recording mode can be selected from 32 levels.)

6 Confirm the setting of timer program, press ◀ to select "COMPLETE", then press SET/ENTER.



- "TIMER PROGRAM LIST" screen is displayed.
- The TIMER indicator on the front of the Recorder lights up and timer programming is completed.

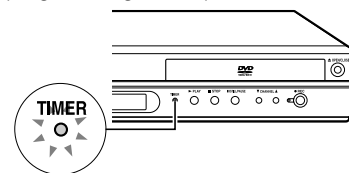

Continued on Next Page ▶▶▶

Timer Recording

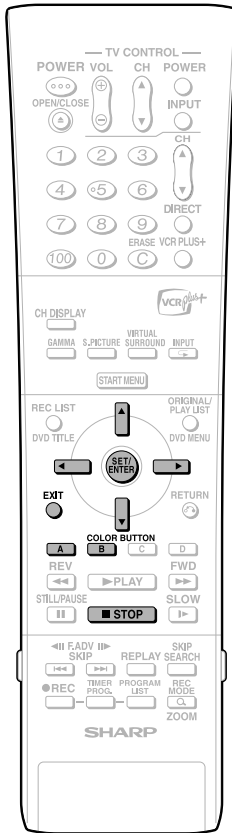

7 Confirm the programs on the list and then press **SET/ENTER**.

- Timer Setting will be completed and the recording method selection screen will appear. To continue timer recording with VCR Plus+, press **SET/ENTER** and follow the same procedure from step 2.

8 Press **EXIT** to complete VCR Plus+ timer setting.

NOTE

Timer Recording from an External Equipment (e.g. CATV box) using VCR Plus+ System

- Press ◀/▶ in step 4 to select "AIR/CATV", then press ▲/▼ to select "EXT.". Next, press ◀/▶ to select "CH", then press ▲/▼ to select the input used for external equipment connection (L1/L2/L3), and then press **SET/ENTER**.

To Correct Date in Step 4

- Press ◀/▶ to select the date, then press ▲/▼ to correct.

To Correct Time in Step 4

- Press ◀/▶ to select hour or minute, then press ▲/▼ to correct.

To Set Daily and Weekly Timer Program

- Press **Blue (A)** or **Red (B)** in step 4. Each time you press the button, setting changes as shown below:

Blue (A)
(DAILY): DAILY → MO-SAT → MO-FRI

Red (B)
(WEEKLY): SUNs → MONs → FRIs → SATs

- A message will be displayed when two or more timer programs overlap.
- If an error message is displayed, confirm the PlusCode number and input the correct number.
- Timer recording will not start during disc playback.
- When the power is off while recording timer is set, front display panel will light up once timer recording starts. If you want to turn off the light, set "LCD BACKLIGHT REC." (page 82) to "YES".

You can also turn off the light, by pressing **BACK LIGHT** on the remote control (under the cover) for more than 2 seconds.

Convenient Functions When Recording Exact Recording (page 76)

- If you set EXACT RECORDING to "YES", the Recorder will automatically adjust the recording mode of timer recording so the recorded programs will fit on one disc.

To check, change or cancel timer settings

- See page 43.

To stop recording while timer recording is in progress

- If you press **STOP**, "TIMER RECORDING IS IN PROGRESS. IF YOU PRESS THE STOP BUTTON ONCE MORE, TIMER RECORDING CANCELS AND RECORDING STOPS." will appear on the screen. Even that message goes out of the screen, pressing **STOP** one more time will stop the recording.

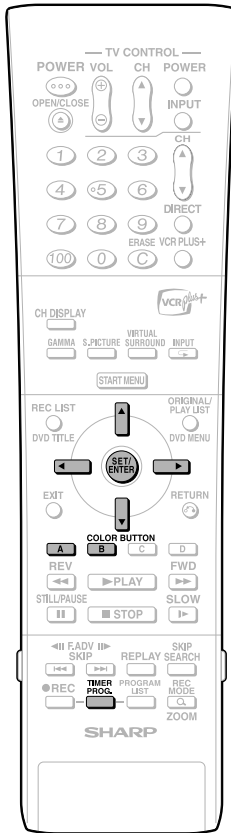

Timer Recording by Specifying Date, Time and Channel

DVD-RW | **DVD-RW** | **DVD-R**
VR MODE | VIDEO MODE

- You can timer record up to 8 programs scheduled within a year, including VCR Plus+ System and Easy Recording Guide.

Preparation for Timer Recording

- Check that the clock is displaying the correct time.
- Preset the channels.
- When you record SAP broadcast, set "SAP SETTING" to "ON" (see page 76).
- When recording from an external equipment such as a CATV box or satellite receiver, turn on the power of the external equipment.

! Important!

- When setting the timer recording, make sure recordable disc is loaded.

Example: Recording a TV program in the FINE mode: the TV program is on channel 123 starting at 9:05 AM and stopping at 10:35 AM on December 26.

1 Press **TIMER PROG.** to display the **TIMER PROGRAM/CHECK** screen.

- You can select the recording method on this screen.
- You can also start timer recording by selecting "TIMER PROGRAM/CHECK" in the START MENU.

2 Press **▲/▼** to select "**TIMER PROGRAM**", then press **SET/ENTER**.

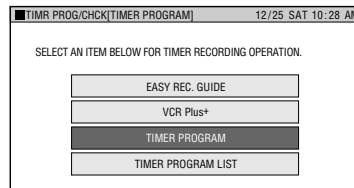

3 Press **▲/▼** to select the desired month/day (**DATE**), then press **▶**.

Example: December 26

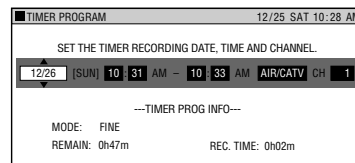

To Set Daily or Weekly Timer Program

- Press **Blue (A)** or **Red (B)**. Each time you press the button, setting changes as shown below:

Blue (A) (DAILY): DAILY → MO-SAT → MO-FRI

Red (B) (WEEKLY): SUNs → MONs → FRIs → SATs

4 Press **▲/▼** to set the recording start time (hour), then press **▶**.

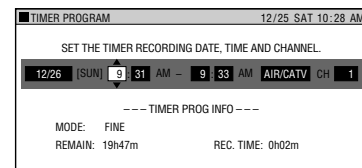

5 Press **▲/▼** to set the recording start time (minute), then press **SET/ENTER**.

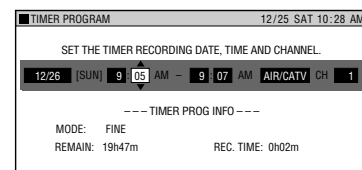

6 Set the recording stop time (hour and minute) in the same manner as steps 4 and 5, then press **▶**.

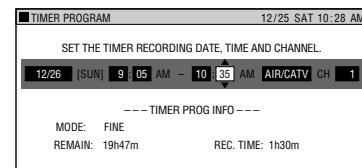

7 Press **▲/▼** to select the desired input source (**AIR/CATV** or **EXT.**), then press **▶**.

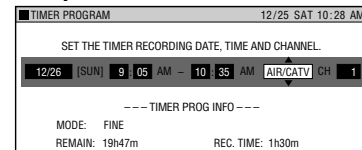

8 Press **▲/▼** to select the desired channel (input) number, then press **▶**.

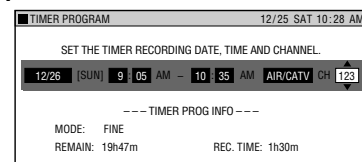

Continued on Next Page ▶▶▶

Timer Recording

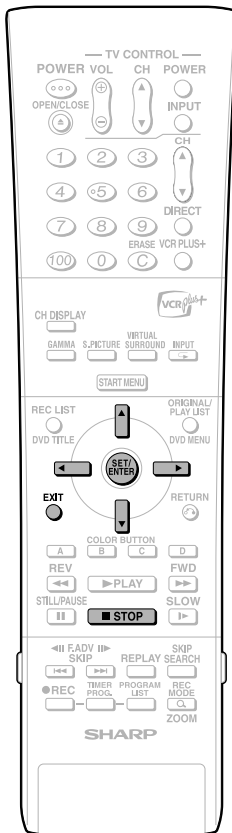

9 Press **◀/▶** to select “REC. MODE”, then press **SET/ENTER**.

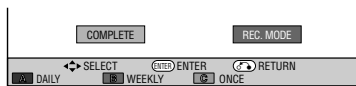

10 Press **▲/▼** to select the recording mode, then press **SET/ENTER**.

- If there is not enough empty space (time), a message is displayed. Select the recording mode again.

When “MANUAL SETTING (MN)” is selected:

- Select the recording mode with **◀/▶**, then press **SET/ENTER**. (The recording mode can be selected from 32 levels.)

11 Confirm the setting of timer program, press **◀** to select “COMPLETE”, then press **SET/ENTER**.



- “TIMER PROGRAM LIST” screen is displayed.
- The TIMER indicator on the front of the Recorder lights up and timer programming is completed.

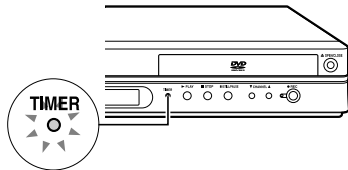

12 Confirm the programs on the list and then press **SET/ENTER**.

- Program that has just been set is selected.
- The screen in step **2** is displayed.
- If you want to timer record more programs, repeat from step **2**.

13 Press **EXIT** to complete timer setting.

- Timer recording will function even after you turn the power off.

NOTE

To Correct Date in Step 3

- Press **◀/▶** to select the date, then press **▲/▼** to correct.

To Correct Time in Step 4, 5, 6

- Press **◀/▶** to select hour or minute, then press **▲/▼** to correct.

To Set Daily and Weekly Timer Program

- Press **Blue (A)** or **Red (B)** in step **3**. Each time you press the button, setting changes as shown below:

Blue (A) (DAILY): DAILY → MO-SAT → MO-FRI

Red (B) (WEEKLY): SUNs → MONs → FRIs → SATs

- A message will be displayed when two or more timer programs overlap.
- A message will be displayed if previously set timer programs total 8. Select “NO” and press **SET/ENTER**. Then, cancel unnecessary timer programs.
- Timer recording will not start during disc playback.
- When the power is off while recording timer is set, front display panel will light up once timer recording starts. If you want to turn off the light, set “LCD BACKLIGHT REC.” (page **82**) to “YES”. You can also turn off the light by pressing **BACK LIGHT** on the remote control (under the cover) for more than 2 seconds.

Convenient Functions When Recording Exact Recording (page 76)

- If you set EXACT RECORDING to “YES”, the Recorder will automatically adjust the recording mode of timer recording so the recorded programs will fit on one disc.

To check, change or cancel timer settings

- See page **43**.

To stop recording while timer recording is in progress

- If you press **■STOP**, “TIMER RECORDING IS IN PROGRESS. IF YOU PRESS THE STOP BUTTON ONCE MORE, TIMER RECORDING CANCELS AND RECORDING STOPS.” will appear on the screen. Even that message goes out of the screen, pressing **■STOP** one more time will stop the recording.

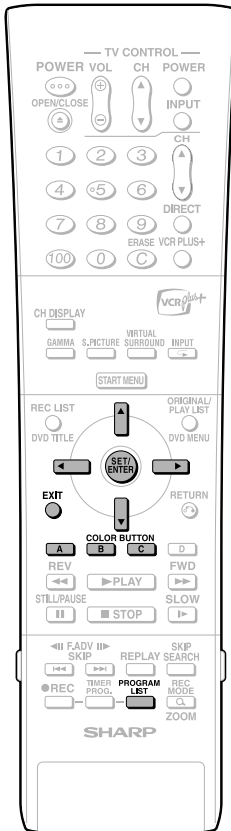

Confirm, Change and Cancel a Timer Program

DVD-RW VR MODE DVD-RW VIDEO MODE DVD-R

- You can confirm, change and cancel the content of timer programs set by "EASY REC. GUIDE", "VCR Plus+" and "TIMER PROGRAM".
- The Timer Program List shows all timer programs set.

Confirming

1 Press PROGRAM LIST to display "TIMER PROGRAM LIST".

- You can also go to the "TIMER PROGRAM LIST" screen by selecting TIMER PROGRAM/CHECK in the START MENU and then TIMER PROGRAM LIST.

| TIMER PROGRAM LIST | | 12/25 SAT 10:28 AM | |
|--|------|--------------------|--|
| CAN CHECK, CHANGE OR CANCEL TIMER PROGRAM. | | | |
| PROGRAM DATE&TIME | CH | REC. MODE | |
| 12/25 SAT 7:00 PM - 7:30 PM | CH 8 | SP | |
| 12/25 SAT 9:05 PM - 9:50 PM | CH 8 | FINE | |
| 12/25 SAT 10:30 PM - 11:00 PM | CH 8 | FINE | |

■ Press PROGRAM LIST or EXIT to complete only the confirmation.

■ Proceed to step 2 if you want to confirm the content of a timer program in detail or change its content.

■ Press one of the Colored buttons to select timer programming screen to add a timer program.

- EASY REC. GUIDE.... Blue (A)
- VCR Plus+.... Red (B)
- TIMER PROGRAMMING.... Green (C)

Confirming the Content of a Timer Program in Detail or Change Its Content

2 Press ▲/▼ to select the program to change, then press SET/ENTER.

| TIMER PROGRAM LIST | | 12/25 SAT 10:28 AM | |
|--|------|--------------------|--|
| CAN CHECK, CHANGE OR CANCEL TIMER PROGRAM. | | | |
| PROGRAM DATE&TIME | CH | REC. MODE | |
| 12/25 SAT 7:00 PM - 7:30 PM | CH 8 | SP | |
| 12/25 SAT 9:05 PM - 9:50 PM | CH 8 | FINE | |
| 12/25 SAT 10:30 PM - 11:00 PM | CH 8 | FINE | |

3 Press ◀/▶ to select "CHANGE", then press SET/ENTER.

| TIMER PROGRAM LIST | | 12/25 SAT 10:28 AM | |
|---|------|--------------------|--|
| 12/25 SAT 9:05 PM - 9:50 PM | CH 8 | REC. MODE: FINE | |
| DO YOU WANT TO CANCEL, CHANGE OR EXIT WITHOUT CHANGING? | | | |
| CANCEL | | CHANGE | |

- CANCEL:** The confirmation screen appears.
- CHANGE:** The Timer Program screen appears.
- EXIT:** The screen in step 2 appears.

4 Change the content of timer program by following the steps on pages 41 and 42.

Canceling a Timer Program

1 Press PROGRAM LIST to display "TIMER PROGRAM LIST".

2 Press ▲/▼ to select the program to cancel, then press SET/ENTER.

| TIMER PROGRAM LIST | | 12/25 SAT 10:28 AM | |
|--|------|--------------------|--|
| CAN CHECK, CHANGE OR CANCEL TIMER PROGRAM. | | | |
| PROGRAM DATE&TIME | CH | REC. MODE | |
| 12/25 SAT 7:00 PM - 7:30 PM | CH 8 | SP | |
| 12/25 SAT 9:05 PM - 9:50 PM | CH 8 | FINE | |
| 12/25 SAT 10:30 PM - 11:00 PM | CH 8 | FINE | |



| TIMER PROGRAM LIST | | 12/25 SAT 10:28 AM | |
|---|------|--------------------|--|
| 12/25 SAT 9:05 PM - 9:50 PM | CH 8 | REC. MODE: FINE | |
| DO YOU WANT TO CANCEL, CHANGE OR EXIT WITHOUT CHANGING? | | | |
| CANCEL | | CHANGE | |

3 Press ◀/▶ to select "CANCEL", then press SET/ENTER.

- The confirmation screen appears.

4 Press ◀/▶ to select "YES", then press SET/ENTER.

- Selected timer program is canceled, and the screen returns to Timer Program List (step 1).

Automatic Recording of Satellite Broadcast (AV AUTO REC)

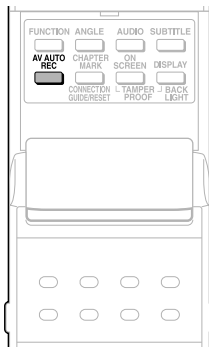
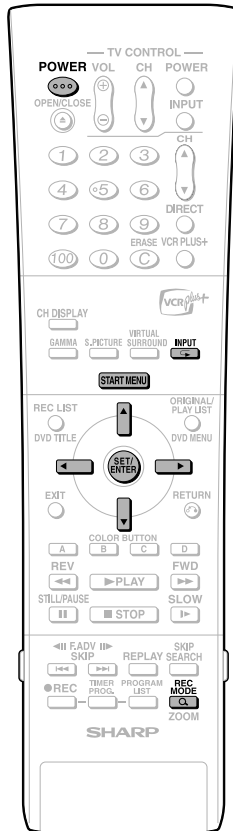

DVD-RW VR MODE DVD-RW VIDEO MODE DVD-R

When connected to a satellite receiver, etc. with a timer recording function, this Recorder can be used to automatically record the timer program. (Refer to the operation manual of the satellite receiver, etc. for instructions on how to set the timer program.)

Example: Use of AV AUTO REC Function

| | | | | |
|--------------------------|-----------------------|----------------|-----------------------|----------------|
| Satellite receiver, etc. | 2:00 AM | 3:00 AM | 4:00 AM | 5:00 AM |
| Set timer program | Timer Program | | Timer Program | |
| This Recorder | 2:00 AM | 3:00 AM | 4:00 AM | 5:00 AM |
| Set AV AUTO REC function | Records timer program | | Records timer program | |
| | Recording begins | Recording ends | Recording begins | Recording ends |
| | Power ON | Power OFF | Power ON | Power OFF |

! Important!

- The AV AUTO REC function only operates when used with a satellite receiver, etc. with timer recording functions.
- The AV AUTO REC function will only operate when the satellite receiver, etc. is connected to the LINE IN 1 (AV AUTO REC) jacks on the rear of the Recorder.

Connecting to a Satellite Receiver, etc.

To use the AV AUTO REC function, connect the satellite receiver, etc. to the **LINE IN 1 (AV AUTO REC) jacks** on the rear of the Recorder.

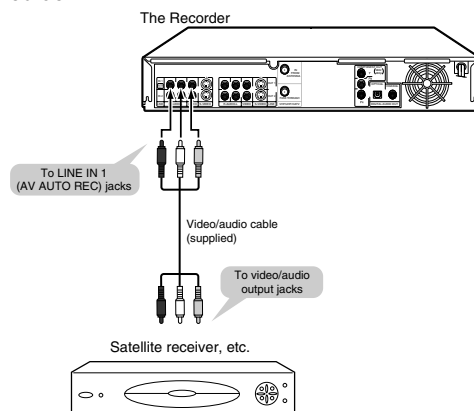

Recording with AV AUTO REC

1 Set up the satellite receiver, etc.

- Set the recording timer on the satellite receiver, etc. for the program you wish to record. (Refer to the operation manual of the satellite receiver, etc. for instructions on how to set the program timer.)

2 Turn off the satellite receiver, etc.

3 ① Press INPUT to select "L1" (LINE IN 1 [AV AUTO REC]).

② Press REC MODE to select recording mode

- The recording mode will change as follows each time you press REC MODE.

→ FINE → SP → LP → EP → MN × ×

- When selecting MNXX, the recording mode will be set to the same as selected in Manual Recording Mode.

4 Select external audio.

- Set "EXTERNAL AUDIO" of "REC. FUNCTION" to "STEREO" or "DUAL MONO" (page 76).

5 Press POWER to turn off the Recorder.

6 Press and hold AV AUTO REC (under the cover) for more than two seconds.

- External automatic recording function switches on or off every time you operate this function.
- "AUTO REC" is displayed on the front display panel (page 17).
- Recording automatically starts and stops when the Recorder receives a signal from satellite receiver, etc. at start time and stop time.

NOTE

- When recording PPV (pay-per-view) programs of satellite broadcasts, always make sure to set the satellite receiver, etc. to "Record". Certain programs may not be recorded or require additional charges for recording.
- Use AV AUTO REC in combination with a satellite receiver, etc. equipped with a timer recording function.
- Since the power of this Recorder is switched on after the video signal from a satellite receiver, etc. has been received, the start of a program may not be recorded.
- When using AV AUTO REC function, it is recommended that you set the timer recording start time for a satellite receiver etc. a little earlier than usual.

Automatic Recording of Satellite Broadcast (AV AUTO REC)

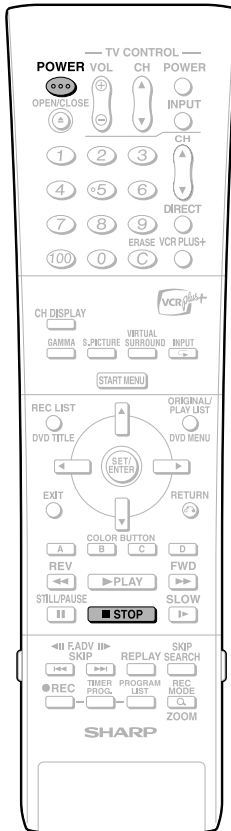

To Cancel the AV AUTO REC Function

Before Recording

Press **POWER**.

- The Recorder is turned on and the AV AUTO REC function will be canceled with the "AUTO REC" indicator on the front display panel turned off.

During Recording

Press **STOP**.

- The "AUTO REC" indicator will be turned off.

- Timer recording is given priority when timer recording and AV AUTO REC times overlap.

Eliminating Problems (Recording, Timer Recording)

When You Cannot Record

| Problem | Suggested Solution |
|--|---|
| <ul style="list-style-type: none">• No disc in the Recorder.• Unrecordable disc is loaded. | <ul style="list-style-type: none">• Load recordable DVD. |
| <ul style="list-style-type: none">• Not enough disc capacity.• Recorder cannot identify the disc. | <ul style="list-style-type: none">• Load recordable DVD with enough capacity. |
| <ul style="list-style-type: none">• Disc is protected. | <ul style="list-style-type: none">• Cancel disc protection or change to new recordable DVD for recording. |

When You Cannot Timer Record

| Problem | Suggested Solution |
|---|---|
| <ul style="list-style-type: none">• No disc in the Recorder. | <ul style="list-style-type: none">• Load recordable DVD. |
| <ul style="list-style-type: none">• Unrecordable disc is loaded.• Not enough disc capacity.• Recorder cannot identify the disc. | <ul style="list-style-type: none">• Load recordable DVD with enough capacity. |
| <ul style="list-style-type: none">• Disc is protected. | <ul style="list-style-type: none">• Cancel disc protection or change to new recordable DVD for recording. |
| <ul style="list-style-type: none">• Number of timer programs set has reached the limit. | <ul style="list-style-type: none">• Erase unnecessary timer programs. |
| <ul style="list-style-type: none">• Playing back the DVD. | <ul style="list-style-type: none">• Stop playing back the DVD more than 3 minutes before timer recording starts. If you don't stop playback until timer recording start time, timer recording will not start. |
| <ul style="list-style-type: none">• In the middle of direct recording. | <ul style="list-style-type: none">• Timer recording does not function during direct recording. Stop direct recording before the preset start time for timer recording. |

NOTE

- If you set multiple timers, and the programmed times overlap, or the end time of the previous timer is the same as the start time of the next timer, timer recording will begin after the preceding timer recording finishes. There will be a delay of up to 1 minute before the next timer recording begins.

DVD/CD Playback

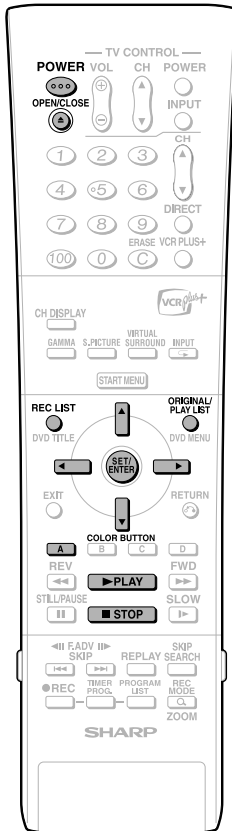

This section explains playback of DVD-RW/R discs recorded with this Recorder, commercially available DVD Video discs (like movies) and CDs.

- To play back a DVD-RW/R recorded with this Recorder, select the title to be played back, and then start playback.
- Display the list of initial images (thumbnails) for each title, and select a title. (REC LIST)

Loading Disc

1 Press **POWER** to turn the power on.

2 Press **OPEN/CLOSE** to open the disc tray.

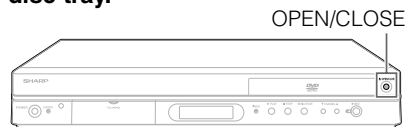

3 Load a disc on the disc tray.



- Insert the disc with the label face up.
- In case of disc recorded on both sides, face the side you want to view down.

4 Press **OPEN/CLOSE** to close the disc tray.

Playback from REC LIST

DVD-RW | **DVD-RW** | **DVD-R**
VR MODE | VIDEO MODE

1 **①** Turn on the power of TV.

- When the recorder is connected to other audio equipment, turn them on as well.

② Set the TV input mode to the mode the recorder is set to.

2 Press **POWER** to turn on the recorder.

- Load a disc you wish to play back.

3 Press **REC LIST** to display **REC LIST (THUMBNAIL)**.

- The REC LIST can also be displayed from the START MENU (see page 28).
- To switch between Original Title List and Play List, press **ORIGINAL/PLAY LIST**. Each time the button is pressed, "ORIGINAL" (original titles) or "PLAY LIST" is selected in turn.

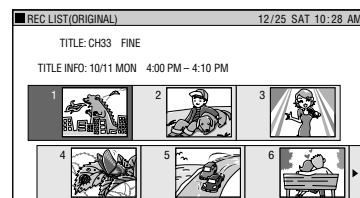

- If you press **Blue (A)** (TITLE LIST), you can switch to title list.

▼ **TITLE LIST**

| ▲BACK | TITLE | REC. DATE | STR. TIME | TIME |
|-------|----------------------------|-----------|-----------|-------|
| 1 | CH33 FINE 2004/10/ 2 SAT P | 10/ 2 SAT | 8:00 PM | 10MIN |
| 2 | CH33 FINE 2004/10/ 9 SAT P | 10/ 9 SAT | 8:00 PM | 10MIN |
| 3 | CH33 FINE 2004/10/16 SAT P | 10/16 SAT | 8:00 PM | 10MIN |
| 4 | CH33 FINE 2004/10/23 SAT P | 10/23 SAT | 8:00 PM | 10MIN |
| 5 | CH33 FINE 2004/10/30 SAT P | 10/30 SAT | 8:00 PM | 10MIN |
| 6 | CH33 FINE 2004/11/ 6 SAT P | 11/ 6 SAT | 8:00 PM | 10MIN |
| ▼NEXT | FROM NEW | | | 77 15 |

- Press **Blue (A)** (THUMBNAIL) to switch from title list to thumbnail.

4 Press **▲ / ▼ / ◀ / ▶** to select the program you want to watch.

Thumbnail screen: Press **▲ / ▼** to switch pages.

Title Name List screen: Press **▲ / ▼** to select a title name.

5 Press **SET/ENTER** or **▶PLAY**.

- Playback begins.
- **PLAY** indicator on the front of Recorder is lit green during playback.

To Stop Playback

Press **■STOP**.

Resume playback function

- If you press **▶PLAY** next, playback will resume from the point where it stopped the previous time. To play back from the beginning, cancel resume mode by pressing **■STOP** then press **▶PLAY**. (Resume playback will be canceled when you open the disc tray or turn the power off)
- Resume playback function does not work during video CD playback.

Continued on Next Page ►►►

DVD/CD Playback

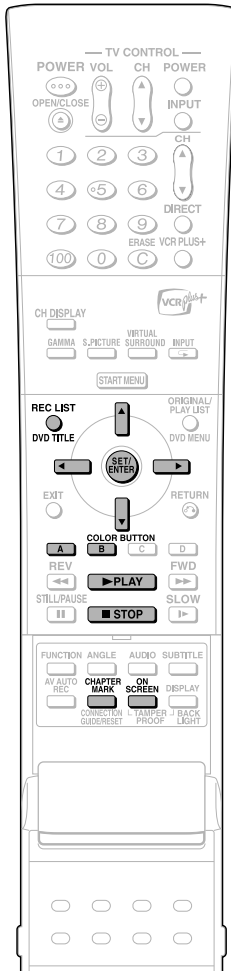

To Record a Chapter Mark during Playback

Press **CHAPTER MARK** (under the cover).

- The message "RECORDED CHAPTER MARK." is displayed, and the chapter mark is recorded.
- Chapter marks can be set during playback only with DVD-RW (VR mode).
- Chapter marks cannot be set manually for DVD-RW (Video mode), DVD-R.

NOTE

- To display the counter during playback, press **ON SCREEN** (page 32).

To play back edited video:

- When playing back video which has been edited (for example, by making a play list), use Seamless Playback for smoother connection between scenes.
- For details on Seamless Playback settings, see page 81.
- The final few seconds may not be played back, depending on how the recording was stopped.
- The end position of the program played back may be shifted slightly from the position where recording was stopped during recording.
- If a title was set with another DVD recorder, and it contains characters which cannot be displayed with the Recorder, then "*****" is displayed (up to 64 characters max.).
- If you play back a play list on a disc recorded with another DVD recorder and 1 title is 12 hours or more in length, only 12 hours of that title will be played back.

About REC LIST

When the REC LIST is displayed, you can use the following functions by pressing **Blue (A)** or **Red (B)** on the remote control.

- Switch between Thumbnail screen and Title Name List screen by pressing **Blue (A)**.
- When Thumbnail screen is selected, switch between Title List and Chapter List by pressing **Red (B)**. Chapters in selected title will be displayed in Chapter List.
- Sort the Title List in the "From New", "From Old" or "Title Name (alphabetical)" order.
 - ① Press **Red (B)**.
 - ② Press **◀/▶** to select "FROM NEW", "FROM OLD" or "TITLE NAME", then press **SET/ENTER**.

Icon Displayed in REC LIST

| | |
|--|---|
| | TITLE PROTECTION (DVD-RW [VR mode] only) |
|--|---|

Playback by Selecting Title

- To play back a disc recorded and finalized in Video mode, press **DVD TITLE**, display the TITLE MENU screen, and select a title to play back.

DVD-RW | **DVD-R**
VIDEO MODE

1 Load a disc recorded in Video mode.

2 Press **DVD TITLE**.

- The TITLE MENU screen is displayed.

3 Press **▲/▼** to select the title.

4 Press **SET/ENTER**.

- Playback of the selected title will begin.

5 To stop playback, press **■STOP**.

NOTE

- If a disc recorded in Video mode has been finalized (pages 14, 84), a menu screen will be created automatically to enable playback with other DVD players. For that reason, the menu screen is different before and after finalization.
- If a title was set with another DVD recorder, and it contains characters which cannot be displayed with this Recorder, then "*****" is displayed (up to 64 characters max.).

If there is a timer program:

- A message to that effect will be displayed 5 minutes prior to the start of the timer recording. If that happens, stop DVD playback and load the disc for recording.
- The timer recording will be canceled at the start time of the timer recording if DVD playback is still in progress.

DVD Video Playback

DVD VIDEO

1 Load a disc.

- Playback may begin automatically, depending on the disc.

2 Press **▶PLAY**.

- Playback begins from the first title.
- The menu may be displayed first, depending on the disc. Perform playback operation by following the directions on the screen.
- To stop playback, press **■STOP**.

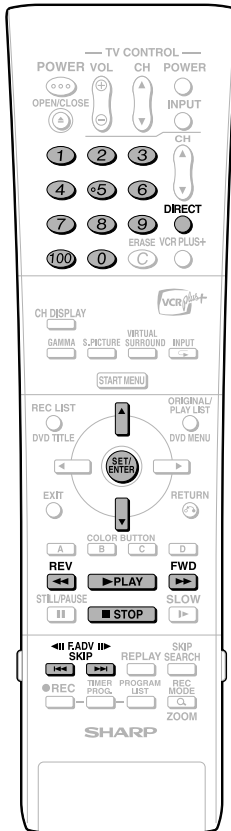

Audio CD/Video CD Playback

VIDEO CD | AUDIO CD

Playback from the beginning

- 1 Load a disc.
- 2 Press **▶PLAY**.
 - Playback begins from the first track.
- 3 To stop playback, press **■STOP**.

Playback by selecting the track

- 1
 - ① Press **DIRECT**.
 - ② Select the track number to be played back using the **Number** buttons, then press **SET/ENTER**.
 - Playback starts from the selected track.
 - Example:** To select the 12th song (track), press **1**, then **2**.
 - You can also select the track by pressing **▲/▼**.
 - **DIRECT** does not work when playing back a video CD with PBC on.

- 2 To stop playback, press **■STOP**.

Video CD (with PBC) Playback

- Some video CD discs have Playback Control (PBC) function which guides the playback by the menu displayed.

Video CD (with PBC)

If you press **▶PLAY** after you load a disc, the menu displays. The functions of button changes in the following manner during the playback operation using the menu.

- **▶▶▶** becomes the "NEXT" button.
 - **◀◀◀** becomes the "PREVIOUS" button.
- Select the track number to be played back from the menu using the **Number** buttons and play back the track.

Example: To select the 5th track, press **0**, then **5**.

(Operation method may differ depending on the disc. Refer to the manual of the video CD.)

Turning off PBC function when playing back a PBC compatible video CD

Playback begins from track 1 when **▶▶▶FWD** is pressed before the menu is displayed after you load a disc. Playback will follow the track order like an audio CD.

- * If you want to turn the PBC to "ON" when playing back the CD with PBC off, press **■STOP** twice and then press **▶PLAY** to display the menu.

Other Types of Playback

DVD-RW | DVD-RW | DVD-R | DVD VIDEO | VIDEO CD
 VR MODE | VIDEO MODE
 AUDIO CD

- This section explains other types of DVD playback operations.

Fast Forward/Reverse (Search)

Use to fast forward/reverse programs being played.

- 1 Press **▶▶▶FWD** or **◀◀◀REV** during playback.

Example: When **▶▶▶FWD** is pressed

- The search speed will cycle as follows each time you press the button.

When playing back a DVD



When playing back a video CD or audio CD

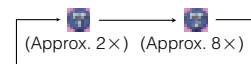

- 2 Press **▶PLAY** to cancel the search.

- Search will be canceled and playback screen is displayed.
- You cannot fast forward or fast reverse from one title and continue to another title.
- When you fast forward or fast reverse to the end or beginning of the title, normal playback screen is displayed automatically.

Skipping to Next Chapter

You can skip the chapter using this function.

Press **◀◀◀** or **▶▶▶** during playback.

- Press **▶▶▶** to go to the start of the next chapter.
- Press **◀◀◀** once to return to the start of current chapter (track). If you press it again (within about 5 seconds), it will skip to the beginning of the previous chapter (track).

Continued on Next Page ▶▶▶▶

DVD/CD Playback

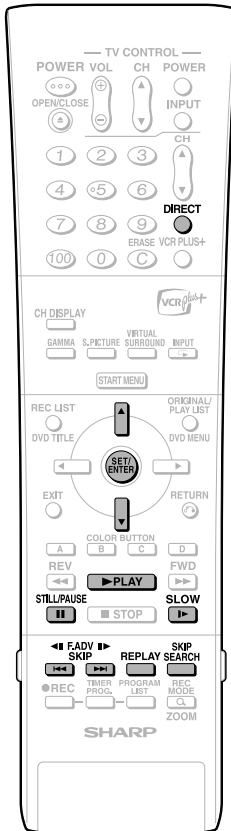

Slow Playback

This lets you play back video at slow speed.

1 Press **▶SLOW** during playback.

- The slow playback speed will cycle as follows each time you press the button.

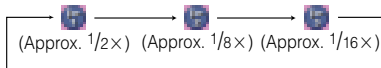

2 Press **▶PLAY** to return to normal playback.

- You cannot perform slow playback over a boundary between titles. At the end of the title, slow playback will be canceled and normal playback will be selected automatically.

Still Picture Playback/ Frame Advance Playback

This feature enables still playback and frame advance playback.

1 Press **||STILL/PAUSE** during playback.

- Playback pauses.
- PLAY indicator on the front of Recorder blinks during Still Picture Playback.
- If you are playing back an audio CD, the CD will pause.

2 Press **▶▶** or **◀◀** to advance or reverse playback image frame by frame.

- Press **▶▶** to advance one frame. Press **◀◀** to reverse one frame.
- Frame Reverse Playback will not work with DVD-RW (Video mode), DVD-R, DVD-Video and Video CD discs.

3 Press **▶PLAY** to return to normal playback.

Skip Search

This lets you skip about 30 seconds ahead. This is convenient when you want to skip commercials while viewing.

Press **SKIP SEARCH** during playback.

- You can skip approximately 30 seconds forward each time you press the button.
- The maximum interval you can skip at one time is 120 seconds (4 button presses).

Replay

This lets you skip about 10 seconds back. This is convenient for replaying a short scene you missed.

Press **REPLAY** during playback.

- Playback reverses approximately 10 seconds, then starts again.

Playback by Selecting a Title (Track) Number (Direct Playback)

1 Press **DIRECT** while playback stops or during playback.

2 Press **▲ / ▼** to select the title number you want to see, then press **SET/ENTER**.

Title number currently selected

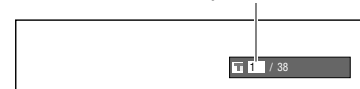

- Playback starts from the beginning of the selected title.

NOTE

- You can select the title number to play back by using Function Control screen (page 56).

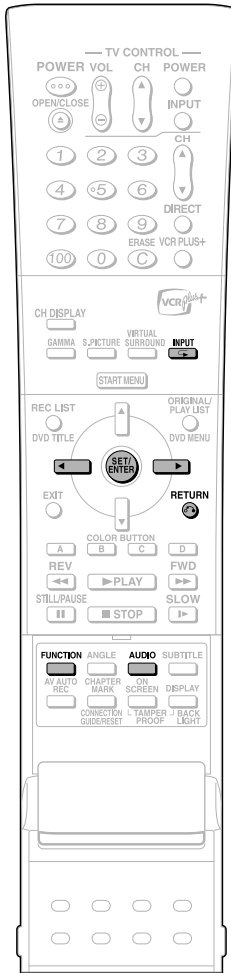

Repeat Playback of a Title or Chapter (Repeat Playback)

- 1** Play back the title or chapter you want to repeat.
- 2** Press **INPUT**.
- 3** Press **◀/▶** to select the type of Repeat Playback.

- **TITLE:** Repeats the title currently playing back.
- **CHAPTER:** Repeats the chapter currently playing back.
- **A-B:** Repeats the specified scene of title or chapter.

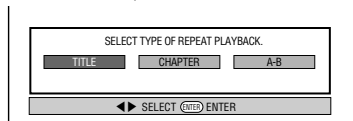

- Press **RETURN** to cancel without setting the type of Repeat Playback.

- 4** Press **SET/ENTER**.
Example: Repeat playback of a title (TITLE).



- 5** Press **INPUT** to return to normal playback.

A-B Repeat Playback (Repeat Playback of a Specified Part)

- 1** Press **INPUT** during playback.
- 2** Press **◀/▶** to select "A-B", then press **SET/ENTER**.
- 3** Press **SET/ENTER** when you reach the scene you want to start Repeat Playback.

- The start point of the part (A) will be memorized.

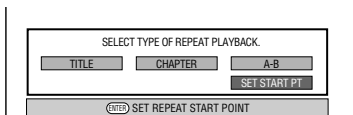

- 4** Press **SET/ENTER** when you reach the scene you want to end Repeat Playback.
- The end point of the part (B) will be memorized and the Repeat Playback for the specified part (A-B) starts.

- 5** Press **INPUT** to return to normal playback.

Function Control

You can do things like specify a title or chapter, and adjust settings for video and audio if you press **FUNCTION** (under the cover) during playback. (For details see page 56.)

Switching Audio

You can change the audio output channel using the **AUDIO** button (under the cover).

Each time **AUDIO** is pressed, the audio channels change as follows:

AUDIO CD | **VIDEO CD**

→ L+R → L → R

DVD VIDEO

The sound number which is currently played back will be displayed.

DVD-RW | **DVD-RW** | **DVD-R**
VR MODE | VIDEO MODE

The sound you can select varies depending on the sound recorded on the disc. (page 77)

- When recording SAP broadcast or stereo, the way audio channel changes may differ depending on the recorded sound. See the table of SAP on page 77 for details.

NOTE

- When you play a program recorded in dual mono, and if you are listening to the Dolby Digital sound via the digital output jack, you cannot select the audio channel. Set "DIGITAL AUDIO OUTPUT" to "PCM" (see page 80), or if you want to change the audio channel, listen via the analog output jacks.

DVD/CD Playback

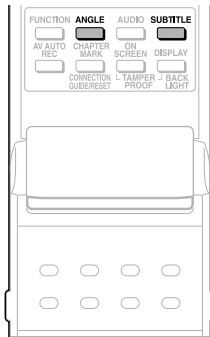
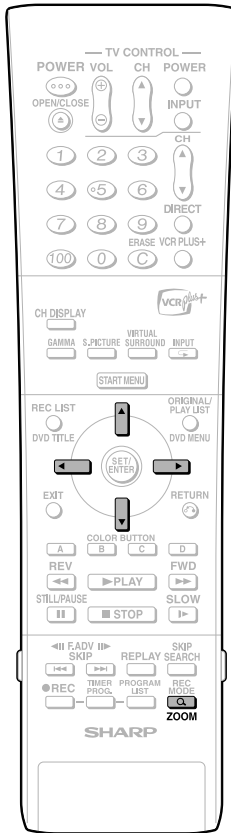

Switching Subtitles

DVD VIDEO

If subtitles are provided in multiple languages, you can switch between them.

1 Press **SUBTITLE** (under the cover) during playback.

- The display indicates the subtitle number currently being played back, and the subtitles appear.
- "XX" is displayed if a disc has no subtitles.

2 Press **▲/▼** to select the subtitles you want to see.

- You can select by pressing **SUB-TITLE**.
- The display indicates the subtitle number currently being played back, and the subtitles appear.
- To hide the subtitles, press **◀/▶** a few times and select "OFF". You can also select "OFF" by pressing **SUBTITLE** or **▲/▼**.

Zoom

You can magnify your favorite section by pressing **QZOOM** during playback.

- Each time you press this button, the zoom setting cycles in the following sequence: ZOOM: 1 (approx. 1.2X) → ZOOM: 2 (approx. 1.5X) → ZOOM: 3 (approx. 2.0X) → OFF (No display)
- You can move the enlarged part with **▲/▼/◀/▶**.



Switching Angle

DVD VIDEO

If multiple angles are recorded, you can switch between them.

Press **ANGLE** (under the cover) during playback.

- The display indicates the angle number currently being played back. Each time you press this button, the angle switches.
- The angle can also be switched by pressing **▲/▼**.
- "XX" is displayed if a disc is recorded with only one angle.



To return to the previous angle, press **ANGLE** (under the cover) a few times to select the original angle.

NOTE

Display of functions

- The display for subtitle, angle or audio automatically disappears after 10 seconds. The display can also be hidden by pressing **SET/ENTER**.

Switching between functions

- You can switch subtitle, angle and audio at the Function Control screen (page 56).
- Operation for each function varies depending on the disc. See the manual for the disc.
- The following operations will not work when playing back an audio CD: Replay, Slow Playback, Frame Advance/Reverse

Fast Forward/Reverse

- You cannot perform Fast Forward/Fast Reverse over a boundary between titles. At the end or beginning of the title, Fast Forward/Fast Reverse will be canceled and normal playback will be selected automatically.
- Audio is not played back during Fast Forward and Fast Reverse.
- Audio and subtitles are not played back with DVD video discs and video CDs.
- Depending on the disc and the scene being played back, the Recorder may not operate at the speed listed in this manual when performing Fast Forward.

Slow Playback

- You cannot perform slow playback over a boundary between titles. At the end of the title, slow playback will be canceled and normal playback will be selected automatically.

Repeat Playback

- Repeat Playback will not work during PBC playback of a video CD with PBC (Playback Control).
- Repeat Playback may be forbidden depending on the disc.
- A-B Repeat Playback may not work in multi-angle scenes.
- For A-B Repeat Playback, set the start and end points within the same title.

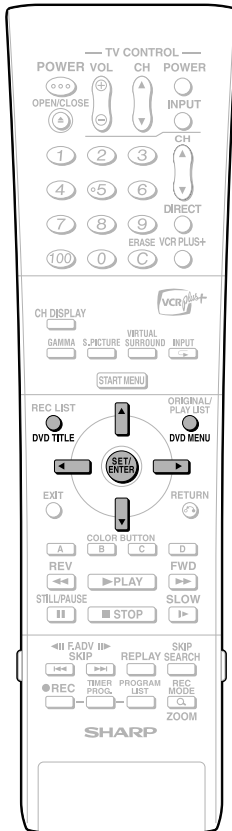

Playback by Selecting with the Menu in the DVD

DVD-RW **DVD-R**
VIDEO MODE

- This section explains how to play back a DVD video disc with a top menu or disc menu.
- Titles listed in the title menu, and a disc guide (for options like subtitles and audio languages) are given in the disc menu.

Playback by Selecting a Title from the Title Menu

1 Press **DVD TITLE**.

- The title menu screen is displayed.



2 Press **▲/▼/◀/▶** to select the title, then press **SET/ENTER**.

- The selected title is played back.

NOTE

- The procedure explained on this page is the basic operation procedure. Procedures vary depending on the DVD video disc, so operate by following the instructions in the DVD video disc manual, or the instructions displayed on the screen.
- A title menu is not displayed for a DVD-RW/R (Video mode) if it has not been finalized.

Title menu

- With some DVD discs, the top menu may be explained using the name "Top Menu". For the button explained as the top menu key, use **DVD TITLE** on the remote control.
- If no title menu is available, the title menu will not display even if **DVD TITLE** is pressed.

Using the Disc Menu

Example: Select "SUBTITLE LANGUAGE".

1 Press **DVD MENU**.

- The disc menu screen is displayed.

2 Press **▲/▼** to select "**SUBTITLE LANGUAGE**".

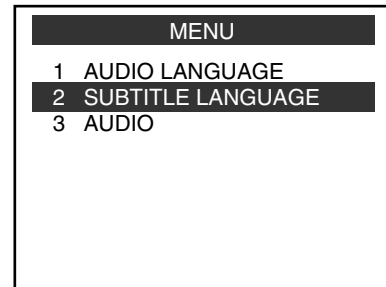

3 Press **SET/ENTER**.

- Screen to select subtitle language is displayed.

4 Press **▲/▼** to select the subtitle language.

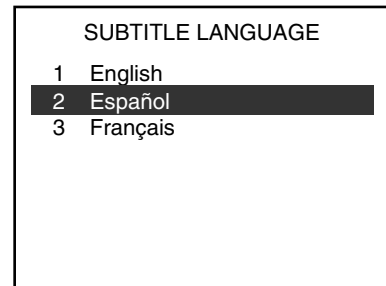

5 Press **SET/ENTER**.

Continued on Next Page ▶▶▶

DVD/CD Playback

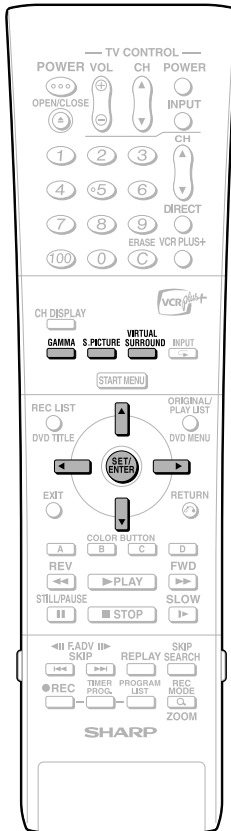

Setting a Clear Image and Powerful Sound

You can set picture quality and enjoy more realistic sound according to your taste.

Digital Gamma (Viewing Dark Images)

Dark images can be made brighter and clearer.

DVD-RW DVD-RW DVD-R DVD VIDEO
VR MODE VIDEO MODE
VIDEO CD AUDIO CD

1 Press **GAMMA** to display the currently selected Gamma mode. If "ON" is not selected, press **▲/▼** to select "ON".

- Each time you press **GAMMA**, the Gamma mode switches between "ON" and "OFF".

2 Press **◀/▶** to adjust the level.

- You can select from 3 levels.
- Press **▶** to increase the level. Press **◀** to decrease the level.
- To cancel, press **GAMMA** until "OFF" appears on the screen.

3 Press **SET/ENTER**.

Digital Super Picture (Increase Sharpness)

DVD-RW DVD-RW DVD-R DVD VIDEO
VR MODE VIDEO MODE
VIDEO CD

It is possible to sharpen images by increasing detail and outline. It is also possible to obtain clearer images by reducing interference.

1 Press **S.PICTURE** to display the currently selected mode. If "ON" is not selected, press **▲/▼** to select "ON".

- Each time you press **S.PICTURE**, the Digital Super Picture mode switches between "ON" and "OFF".

2 Press **◀/▶** to adjust the level.

- You can select from 4 levels.
- Press **▶** to increase the level. Press **◀** to decrease the level.
- To cancel, press **S.PICTURE** until "OFF" appears on the screen.

3 Press **SET/ENTER**.

Dolby Virtual Surround (3-D Feeling Sound)

DVD-RW DVD-RW DVD-R DVD VIDEO
VR MODE VIDEO MODE
VIDEO CD AUDIO CD

You can enjoy surround sound with a TV that has analog stereo (2ch) or with audio equipment. This may be less effective or not effective at all with some discs.

1 Press **VIRTUAL SURROUND** to display the currently selected mode. If "ON" is not selected, press **▲/▼** to select "ON".

- Each time you press **VIRTUAL SURROUND**, the Dolby Virtual Surround mode switches between "ON" and "OFF".

2 Press **SET/ENTER**.

NOTE

- Each indicator will only appear for a few seconds.
- Digital Gamma, Digital Super Picture and Dolby Virtual Surround can be set using the Function Control screen (page 56) as well.

MP3 File Playback

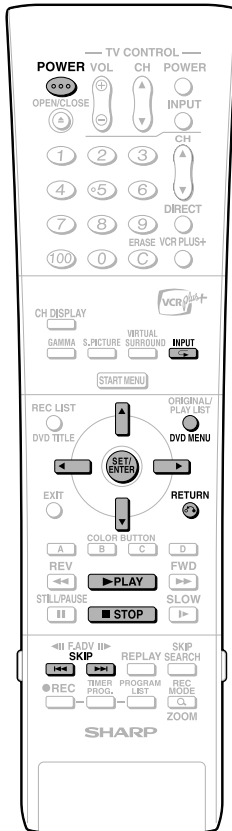

CD-R MP3 CD-RW MP3

NOTE

- See page 11 for details about the MP3 file format.

- 1 Turn on the power of TV.
 - When the recorder is connected to other audio equipment, turn them on as well.
- 2 Switch TV input to the AV input used to connect to the Recorder.

- 2 Press **POWER** to turn on the recorder.

- 3 Load an MP3 recorded CD-R or the CD-RW, then press **DVD MENU**.



- 4 Press **▲/▼/◀/▶** to select the folder you want to play, then press **SET/ENTER**.
 - The file (music title) in the folder is displayed on the file selection screen.



- Press **RETURN** to return to the folder selection screen.
- If you press **▶PLAY** after selecting the folder, the playback screen is displayed, and the files in that folder will be played from the beginning repeatedly.

- 5 Press **▲/▼/◀/▶** to select the file (music title) you want to play and then press **SET/ENTER**.
 - Playback will start from the selected file (music title).



- 6 Press **■STOP** to stop playback.

To Play Another File (music title) during Playback

- 1 Press **■STOP** to stop playback.
- 2 Press **▲/▼/◀/▶** to select the file (music title) you want to play, then press **SET/ENTER**.
 - The chosen file (music title) will be played.

To Skip the File during Playback

Press **SKIP▶▶▶** or **◀◀◀SKIP**.

- Press **SKIP▶▶▶** to skip forward.
- Press **◀◀◀SKIP** to skip backward.

While the MP3 disc is playing

- Time Search is disabled.
- Programmed Playback is disabled.
- It is possible to repeat one track by pressing **↶ (INPUT)**.
- Dolby Virtual Surround does not operate.

Settings During Playback

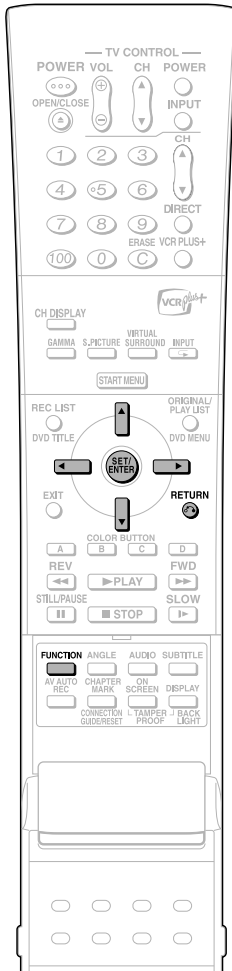

Function Control

DVD-RW | DVD-RW | DVD-R | DVD VIDEO
VR MODE | VIDEO MODE

This lets you make various settings at once, like subtitle and angle setting, and title selection for Direct Playback. Depending on your preferences, you can adjust video and enjoy audio with a greater sense of presence.

Function Control screen

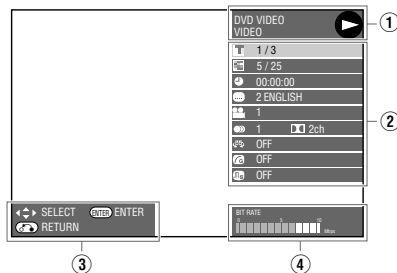

① **Playback status display**
Shows the operation status and disc type.

② **Setting items**
Selects a title or chapter for playback, or performs video/audio settings.

③ **Operation guide display**
Provides help on how to operate with the remote control buttons.

④ **Bit rate display**
Displays the data rate of the video appearing on the TV screen.

Function Control Operation Procedure

1 Press FUNCTION (under the cover) during playback.

- The Function Control screen is displayed on the TV.

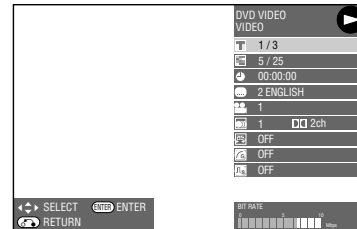

2 Press ▲/▼ to select setting items, then press SET/ENTER.

- For a description of each setting item, see "Functions which can be set" (page 57).

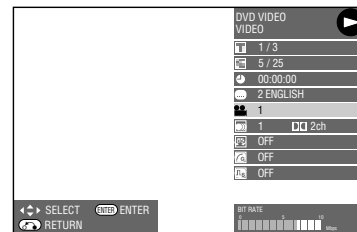

3 Press ▲/▼/◀/▶ to set, then press SET/ENTER.

- Operation may vary depending on the setting item. Operate by following the operation guide instructions on the screen.

4 Press RETURN or FUNCTION (under the cover) to close the Function Control screen.

NOTE

- If "XX" is displayed for an option like title number or subtitles, the disc has no titles or subtitles which can be selected.
- When you press **DIRECT** or **SUBTITLE**, the Function Control screen is closed.
- If you set to the Function Control screen during playback of a DVD video, it may be impossible to operate according to the instructions from the DVD video. In cases like this, operate again after canceling the Function Control screen.

Functions which can be set

Title Number (Direct Title Skip)

- Shows the title number being played back. You can skip to the start of the title.

Chapter Number (Direct Chapter Skip)

- Shows the chapter number being played back. You can skip to the start of the chapter.

Playback Elapsed Time (Direct Time Skip)

- Shows the elapsed time from the beginning of the disc to the present.
This lets you skip based on time.
- Press ◀/▶ to move to the field of Hour, Minute, Second, then press ▲/▼ to set the time. Press **SET/ENTER** to start playback from that set time.

Subtitle Language

- Shows the currently selected subtitle language. If subtitles are provided in other languages, you can switch to your preferred language.

Angle Number

- Shows the currently selected angle number. If the video is recorded with multiple angles, you can switch the angle.

Audio

- Shows the currently selected type of audio. You can select the desired type of audio.

Digital Super Picture

- Emphasizes and enhances definition of details and contours in the video. This reduces noise and makes video easier to see.
- Press ▲/▼ to select "ON" or "OFF", then press ◀/▶ to set the level. Then press **SET/ENTER**.
- There is one setting level on the "soft" side and 3 setting levels on the "sharp" side.
- If you want to enjoy a more defined picture (with detailed pictures), press ▶ while "ON" is displayed for Digital Super Picture. For old movies or videos with a lot of noise, you can reduce noise for an easier to see picture by pressing ◀ while "ON" is displayed for Digital Super Picture.

Digital Gamma

- If a video is dark and hard to see, you can brighten the dark parts for easier viewing by setting Digital Gamma. Set this when watching discs with many dark scenes (i.e. movie and concert discs), and when viewing a disc in a bright room. This lets you see dark parts better and enjoy video with a greater sense of depth.
- Press ▲/▼ to select "ON" or "OFF", then press ◀/▶ to set the level. Then press **SET/ENTER**.
- Digital Gamma can be set to three different levels.

Dolby Virtual Surround

- Lets you enjoy surround audio via analog connection with a stereo type (2ch) TV or audio equipment.
- Even if you use a digital connection, Dolby Virtual Surround will work in the following cases.
 - When playing back linear PCM audio from a DVD.
 - When playing back Dolby Digital audio.
 - When "DIGITAL AUDIO OUTPUT" (page 80) is set to "PCM".
- This Recorder uses a Spatializer System* for Dolby Digital Surround.
 - * Certain audio features of this product manufactured under a license from Desper Products, Inc. *Spatializer*® N-2-2™ and the circle-in-square device are trademarks owned by Desper Products, Inc.
- If audio recorded monaurally is played back with Dolby Virtual Surround ON, the audio level may decrease, making it hard to hear. If this happens, turn Dolby Virtual Surround OFF.
- Dolby Virtual Surround will not work in the following cases:
 - While watching a TV broadcast or external input.
 - Multi-karaoke audio from a karaoke disc, 96 kHz 24-bit linear PCM audio, or DTS audio.
- If you set Dolby Virtual Surround to "ON" and audio sounds abnormal during playback, set it to "OFF".
- There are no level settings.

NOTE

- These functions cannot be used with all discs.

Editing

About Editing

Content that can be edited and editing operations vary according to the recording mode.

Recordings on DVD-RW in VR mode

You can do various types of editing with this Recorder alone. For example it is possible to create a compilation of your favorite videos by gathering your favorite scenes from recorded titles, moving scenes within a specified range, or erasing unnecessary scenes. You can edit original videos you have recorded into a Play List without changing the content of the original videos.

NOTE

- If disc protection is set for a DVD-RW, it cannot be edited.
- If title protection is set, the only editing which can be done is MOVE TITLE.

ORIGINAL

- A recorded video (title) in as is form is called an ORIGINAL. A single recording (from record start to stop) forms a single title.

PLAY LIST

- A title created by editing based on originals is called a PLAY LIST. A play list can be remade any number of times.

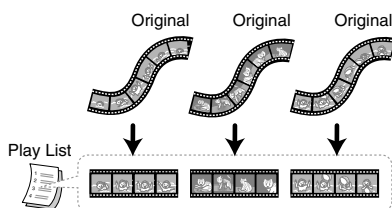

NOTE

- A Play List is a list which describes the playback sequence of originals, and it does not actually copy the originals. This makes it possible to perform editing while using only a little disc space.

Recordings on DVD-RW/R in Video mode

The following content can be edited.

- Input (change) title name (page 62)
- Erase title (page 67)

NOTE

- ERASE TITLE for a recording in Video mode will change settings so that the "erased" title cannot be seen in the REC LIST, but this does not mean that the video is actually erased. (Free time on the disc will not increase. With a DVD-RW recorded in Video mode, free time on the disc will increase when the title recorded last is erased.)
- Editing is not possible if the disc has been finalized (page 84). With a DVD-RW, editing is possible again if finalization is canceled.
- Additional recording and editing can be done using only this Recorder until the disc is finalized.

Editing Procedure

Basic procedure for editing an original title recorded in VR mode

Load a disc.

Select the title to be edited, and edit.

- Erasing Unnecessary Scenes from an Original Title (ERASE SCENE) (page 60).
- Inputting/Changing Title Name (CHANGE TITLE NAME) (page 62).
- Changing Thumbnail (CHANGE THUMBNAIL) (page 64).
- Making Sections in a Title (DIVIDE CHAPTER) (page 65).
- Combining Chapters Together (COMBINE CHAPTERS) (page 66).
- Disabling Title Edit and Erase (TITLE PROTECT) (page 66).
- Erasing All Titles (page 67).
- Erasing by Selecting a Title (or Chapter) (page 67).

Basic procedure for editing titles recorded in VR mode after making a Play List

Load a disc.

Create a Play List.

- Creating from Original Titles (page 68).
- Creating from Part of an Original (page 68).

Select and edit the created play list.

- Erasing All Titles (page 67).
- Erasing by Selecting a Title (or Chapter) (page 67).
- Adding a Scene from an Original to a Play List (ADD SCENE) (page 69).
- Changing the Title Sequence (MOVE TITLE) (page 71).
- Erasing Unnecessary Scenes (ERASE SCENE) (page 72).
- Inputting/Changing Title Name (CHANGE TITLE NAME) (page 72).
- Changing Thumbnail (CHANGE THUMBNAIL) (page 72).
- Making Sections in a Title (DIVIDE CHAPTER) (page 72).
- Combining Chapters Together (COMBINE CHAPTERS) (page 72).

NOTE

Editing cannot be done in the following cases.

- Play Lists cannot be created for discs recorded in Video mode.
- Play Lists cannot be created for recordings on DVD-R.
- Finalized DVD-RWs (Video mode) cannot be edited. (Editing can be enabled by canceling finalization.)

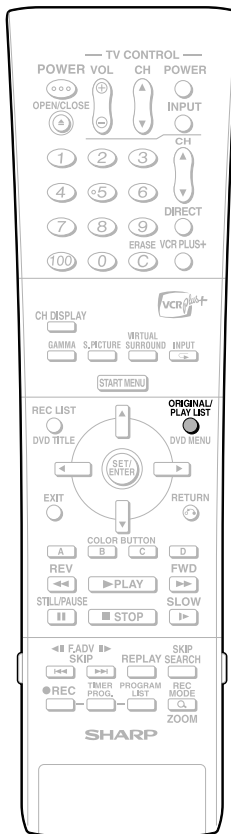

Edit Screen

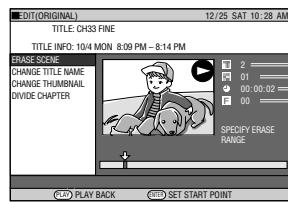

- Title being edited
- Chapter being edited
- Time being edited
- Frame being edited

- There is no frame display for titles recorded in Video mode.

Seamless Playback

This enables smooth playback at the transitions between edited video scenes. (However, a shift of about one second may arise at the transitions, and part of the scene may not appear.) (Page 81)

- Set this function by selecting: "START MENU" → "OTHER SETTINGS" → "ADJUSTMENT" → "OPTION" → "SEAMLESS PLAYBACK".

NOTE

- When you perform editing like adding a chapter mark or erasing a scene, a slight discrepancy may arise between the edit screen and actually edited video.
- If you play back a disc edited at the frame level with another DVD recorder, there may be a shift in the start or end point, or the screen may show a different thumbnail.

Switching between Original and Play List (Play Lists can be created only for VR mode)

Switching when the Recorder power is on

ORIGINAL/PLAY LIST

Press **ORIGINAL/PLAY LIST** in the stopped state. Each time this button is pressed, the setting will toggle between ORIGINAL and PLAY LIST.

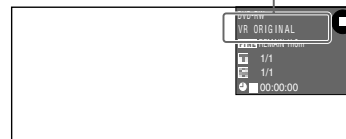

NOTE

- If recording is done while switched to play list, the system will automatically switch back to original.

Switching at the REC LIST

ORIGINAL/PLAY LIST

Press **ORIGINAL/PLAY LIST** at the REC LIST. Each time this button is pressed, the setting will toggle between ORIGINAL and PLAY LIST.

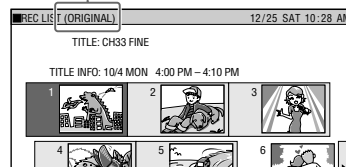

Switching at Edit screen

ORIGINAL/PLAY LIST

Press **ORIGINAL/PLAY LIST** at the EDIT screen. Each time this button is pressed, the setting will toggle between ORIGINAL and PLAY LIST.

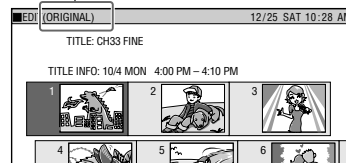

NOTE

- If a Play List has not been created, the "SELECT EDIT OR CREATE PLAYLIST" screen appears.

Editing an Original Title

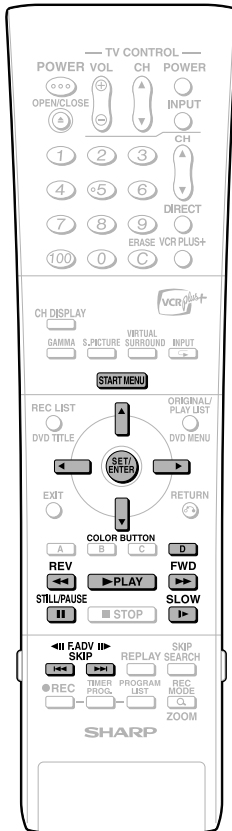

Erasing Unnecessary Scenes from an Original Title (ERASE SCENE)

DVD-RW
VR MODE

Selects a scene from an original video and erase it.

- To erase all titles, see page 67.
- To erase by title (or chapter), see page 67.

NOTE

- Scenes cannot be erased on DVD-RW/R (Video mode) discs.

1 Press **START MENU** to display **START MENU** screen.

2 Press **▲/▼/◀▶** to select “**EDIT/ERASE**”, then press **SET/ENTER**.

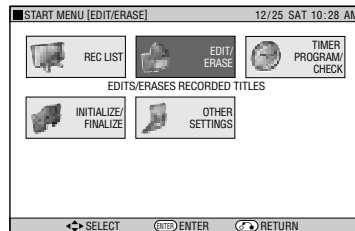

3 Press **▲/▼** to select “**EDIT**”, then press **SET/ENTER**.

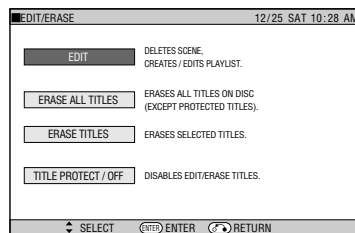

- The Original Edit Title List screen appears.

4 Press **▲/▼/◀▶** to select the **title to edit**, then press **Yellow (D) (EDIT MENU)**.

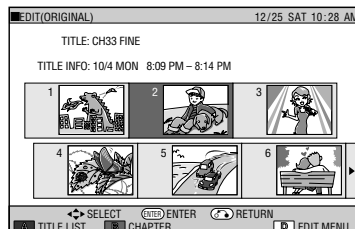

- Edit Menu screen appears.

5 Press **▲/▼** to select “**ERASE SCENE**”, then press **SET/ENTER**.

- The selected title is paused.

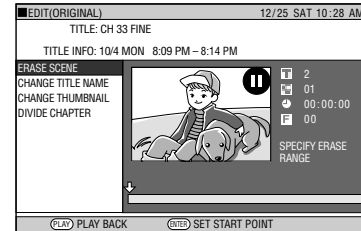

6 Press **▶PLAY** to start playback.

- Find the scene to be erased using **▶▶FWD**, **◀◀REV**, **||STILL/PAUSE**, **◀◀◀**, **▶▶▶**, or **▶SLOW**.

7 Press **SET/ENTER** when you reach the scene to be erased.

- The erase start point is set. (Title playback continues.)

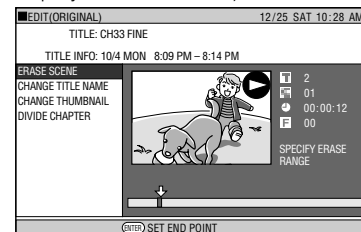

- If you fast reverse to a scene before the start point, the start point will be canceled.
- When the start point is set to near the beginning of a title, the beginning of the title will be selected as the start point. To make the original designated start point effective, set it again after combining the title with the one immediately before.

8 Press **SET/ENTER** when you reach the end of scene to be erased.

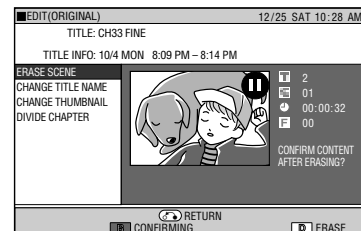

- The erase end point is set. (The title will pause.)
- When the end point is near the end of a title, the end of the title will be selected as the end point. To make the original designated end point effective, set it again after combining the title with the next title.

Editing an Original Title

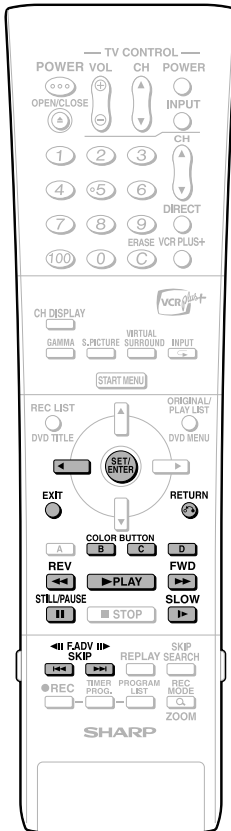

9 Press Red (B) (CONFIRMING) to confirm the contents.

- The title is played back without the scene to be erased.

Press Yellow (D) (ERASE) to erase.

- Go to step 10.
- Press RETURN to cancel scene erase.

10 Press Left Arrow to select "YES", then press SET/ENTER.

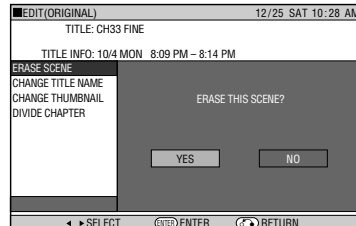

- Erase begins. When erase completes, the screen in step 5 appears.
- If "C (UNDO)" is displayed, you can undo edit by pressing Green (C).
- To quit scene erase, press RETURN. Then the edit screen appears.

11 Press EXIT to exit from Edit mode.

NOTE

Selecting start and end points for scene erase

You cannot set a range shorter than 3 seconds.

- Once you erase a section of an original, it is completely erased. It cannot be restored, so be very careful and confirm before erasing.
- Scenes can only be added and erased a maximum of 50 times per title.
- If scenes have been added 51 or more times to a disc using another DVD recorder, Editing (Recording) may not function.

Searching for the Start Point and End Point Scenes

The following playback operations are available when searching for the start point and end point scenes.

Playback

- If you press PLAY, the currently paused title will be played back.

Skipping to the start of a chapter

- If the scene to be selected is in another title or chapter, first search for the title or chapter using Left Arrow or Right Arrow.

Searching for scenes in a chapter

- REV and FWD are convenient for searching for a scene in a chapter.

Pause

- When you reach a scene near the start point or end point, press STILL/PAUSE to pause. This will make it easier to find the scene. The start and end points may shift slightly.

Frame Advance/Reverse

- If you press FWD after pause, the video will start Frame Advance Playback. If you press REV, it will start Frame Reverse Playback.

Final selection of scene

- To select a scene more accurately, use slow playback starting a little before the scene to be selected. This will keep you from going beyond the scene. If you press SLOW after pausing, you can select a scene at your leisure during slow playback of the video.

Continued on Next Page ▶▶▶

Editing an Original Title

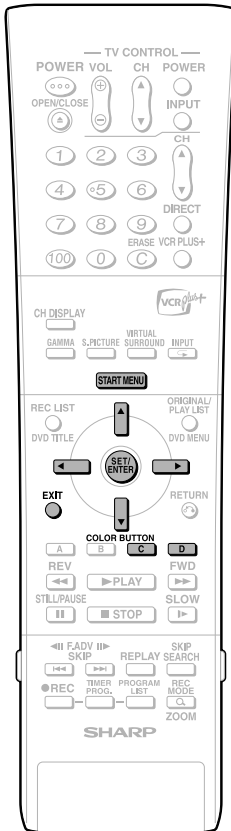

Inputting/Changing Title Name (CHANGE TITLE NAME)

DVD-RW DVD-RW DVD-R
VR MODE VIDEO MODE

- When you record, a title name including the date, time and channel number is automatically created. You can freely change this title name.
- You can input up to a maximum of 64 characters. To input, perform the following steps in order: "Select characters to be changed" → "Delete unnecessary characters (characters to be changed)" → "Input new characters".

NOTE

- Title names cannot be changed in finalized Video mode discs.

- 1 Press **START MENU**.
- 2 Press **▲/▼/◀/▶** to select "EDIT/ERASE", then press **SET/ENTER**.

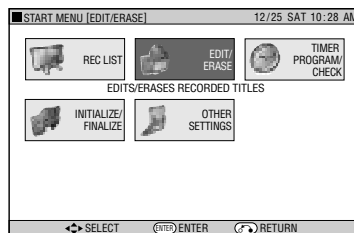

- 3 Press **▲/▼** to select "EDIT", then press **SET/ENTER**.

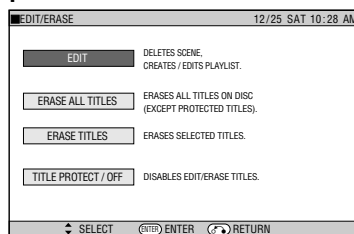

- 4 Press **▲/▼/◀/▶** to select the title to edit, then press **Yellow (D) (EDIT MENU)**.

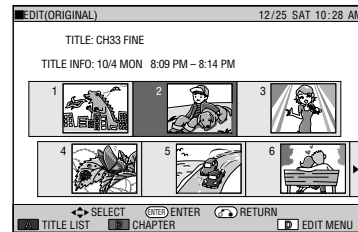

- Edit Menu screen appears.

- 5 ① Press **▲/▼** to select "CHANGE TITLE NAME".

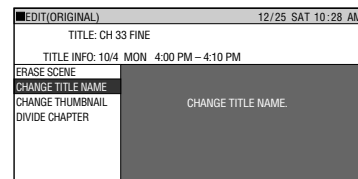

- 2 Press **SET/ENTER**.

- Title Name Change screen appears.

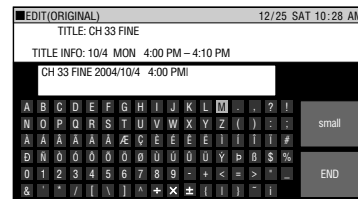

- 6 Change Title Name.

- For information on how to input characters, see page 63.

- 7 Press **▲/▼/◀/▶** to select "END", then press **SET/ENTER** after input is finished.

- The new title is set, and the screen in step 5 displays.

Press **Green (C) (UNDO)** to return to the previously set title.

- The title returns to original name.
- Operate according to the instructions of the screen.

- 8 Press **EXIT** to quit editing.

- Edit mode will terminate.

Editing an Original Title

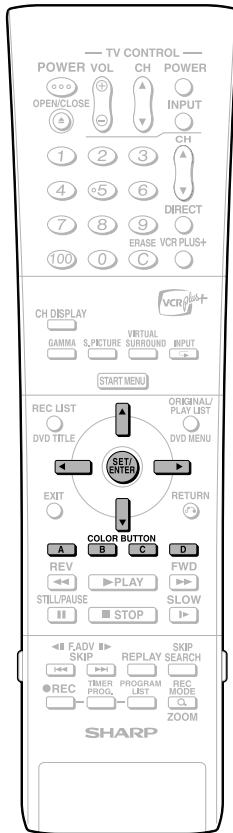

How to Enter Text

DVD-RW | DVD-RW | DVD-R
VR MODE | VIDEO MODE

Input Character Screen

Input field
(Displays title name. Can change and input title name.)

Cursor
(Displays the position to input characters.)

Displays input characters.

Select when you switch between capital letters and small letters.

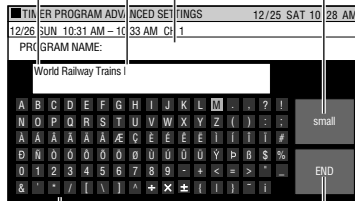

Press ▲/▼/◀/▶ to select the character to be input.

Select when you complete inputting character.

1 Perform the steps from 1 to 4 on page 62.

- Edit Menu screen appears.

2 ① Press ▲/▼ to select "CHANGE TITLE NAME".

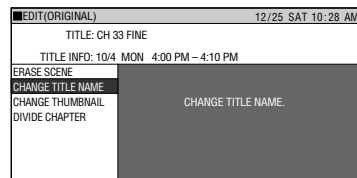

② Press SET/ENTER.

- Title Name Change screen appears.

3 Change title name

① Press Red (B) or Green (C) to select the character to change.

- When you want to insert characters, move the cursor to the position you want to insert by pressing Red (B) or Green (C).

② Press Blue (A) to erase the character to change.



4 Press ▲/▼/◀/▶ to select the character to input, then press SET/ENTER.



- Inputs character in input field.
- To switch between capital and small letters, select "CAPS" or "small", then press SET/ENTER.

5 Input title letters by repeating step 4.

- Press Blue (A) (BACK SPACE) to erase text to the left of the cursor, a character at a time.
- Press Red (B) (BACK) to move the cursor back one space.
- Press Green (C) (FORWARD) to move the cursor forward one space.
- Press Yellow (D) (SPACE) to input a space.
- The maximum number of characters you can input is 64.

6 Press ▲/▼/◀/▶ to select "END", then press SET/ENTER.

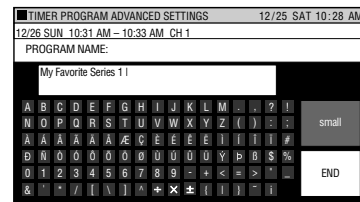

- The screen in step 2 on is displayed.

Continued on Next Page ▶▶▶

Editing an Original Title

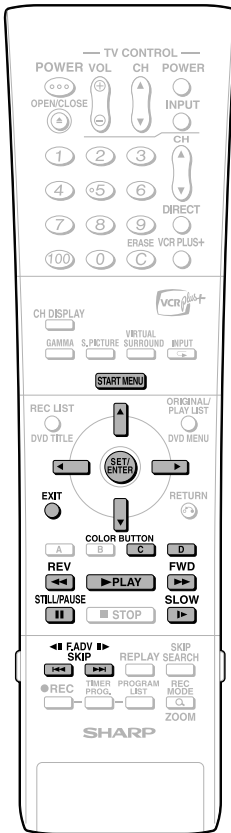

Changing Thumbnail (CHANGE THUMBNAIL)

DVD-RW
VR MODE

Changes the still frame picture displayed at the Thumbnail screen of the REC LIST to your favorite scene within the title.

- 1 Press **START MENU**.
- 2 Press **▲/▼/◀/▶** to select "EDIT/ERASE", then press **SET/ENTER**.

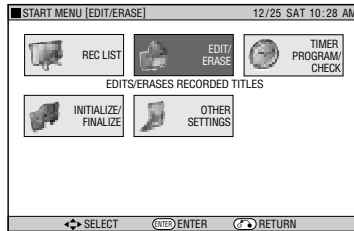

- 3 Press **▲/▼** to select "EDIT", then press **SET/ENTER**.

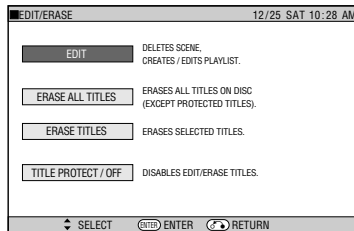

- The Original Edit Title List screen appears.

- 4 Press **▲/▼/◀/▶** to select the title to edit, then press **Yellow (D) (EDIT MENU)**.

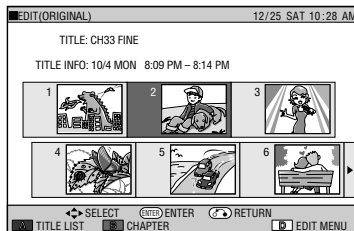

- Edit Menu screen appears.

- 5 ① Press **▲/▼** to select "CHANGE THUMBNAIL".

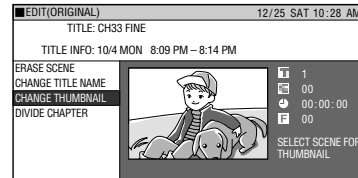

- 2 Press **SET/ENTER**.

- 6 Press **▶PLAY** to start playback.

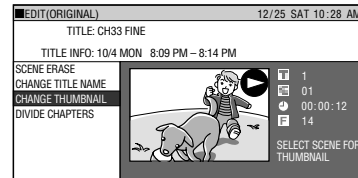

- Find the scene you want to use as a thumbnail using **▶▶FWD**, **◀◀REV**, **||STILL/PAUSE**, **◀◀**, **▶▶**, or **▶SLOW**.

- 7 Press **SET/ENTER** when you reach the scene you want to use as a thumbnail.

- Playback is paused.

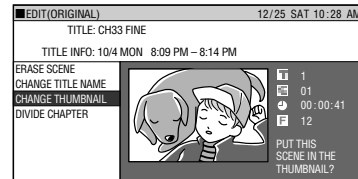

- 8 ① If this is the screen you want, select "YES" by pressing **◀/▶**.

- If you select "NO", you can return to step 5 and select the scene again.

- 2 Press **SET/ENTER**.

- The new Thumbnail screen is set, and the system returns to the screen in step 5.

Press **Green (C) (UNDO)** to return to the previously set thumbnail.

- Operate according to the instructions of the screen.

- 9 Press **EXIT** to quit Thumbnail edit.

- Edit mode will terminate.

Editing an Original Title

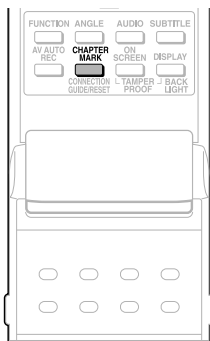
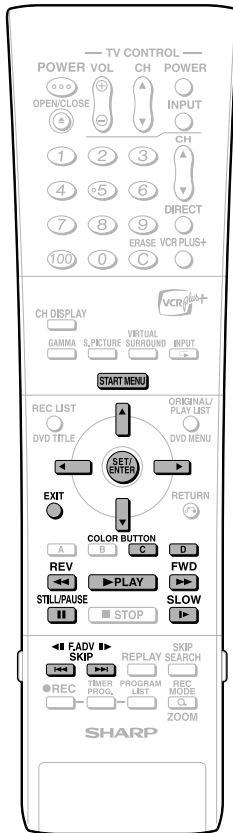

Making Sections in a Title (DIVIDE CHAPTER)

DVD-RW
VR MODE

Divides a title into multiple chapters and makes editing and dubbing of chapter as unit easier.

- You can set chapter divisions by pressing **CHAPTER MARK** (under the cover) during recording or playback.

1 Press **START MENU**.

2 Press **▲/▼/◀/▶** to select "EDIT/ERASE", then press **SET/ENTER**.

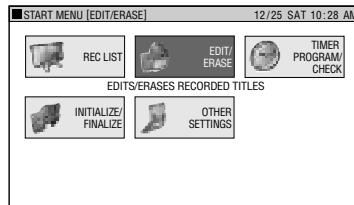

3 Press **▲/▼** to select "EDIT", then press **SET/ENTER**.

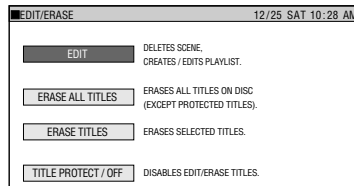

4 Press **▲/▼/◀/▶** to select the title to edit, then press **Yellow (D) (EDIT MENU)**.

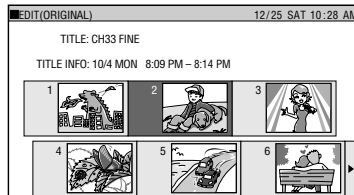

5 Press **▲/▼** to select "DIVIDE CHAPTER", then press **SET/ENTER**.

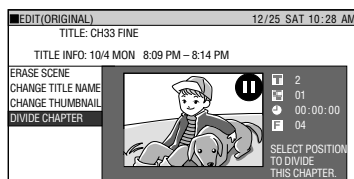

6 Press **▶PLAY** to start playback.

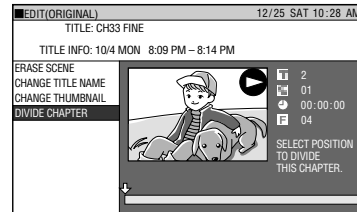

- Find the scene to erase using **▶▶FWD**, **◀◀REV**, **||STILL/PAUSE**, **◀◀◀**, **▶▶▶**, or **▶SLOW** on the remote control.

7 Press **SET/ENTER** at the point where you want to divide.

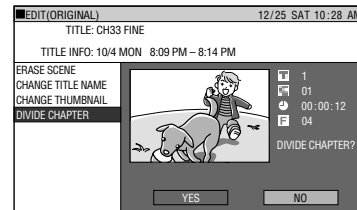

8 Press **◀/▶** to select "YES", then press **SET/ENTER**.

- To continue dividing, repeat steps 5 to 7.

To cancel a chapter division, press Green (C) (UNDO).

- Operate according to the instructions on the screen.

9 Press **EXIT** to quit editing.

- Edit mode will terminate.

NOTE

- You cannot divide a chapter into a section which is less than 3 seconds.

Continued on Next Page ▶▶▶

Editing an Original Title

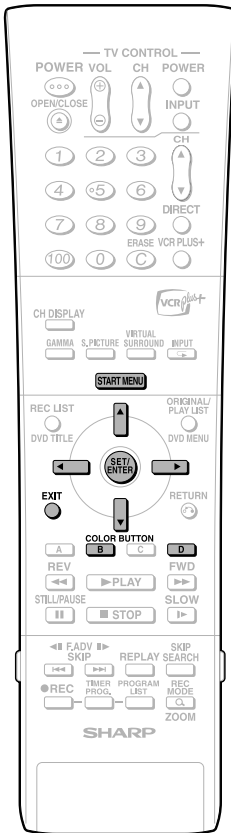

Combining Chapters Together (COMBINE CHAPTERS)

DVD-RW
VR MODE

Combines two adjacent chapters into a single chapter.

NOTE

- You cannot combine chapters automatically recorded when a scene was erased, or chapters recorded due to adding a scene to a Play List.

- 1 Select "EDIT/ERASE" in START MENU screen, then press SET/ENTER.
- 2 Press ▲/▼ to select "EDIT", then press SET/ENTER.
- 3 Press ▲/▼/◀/▶ to select the title you wish to edit.
- 4 Press Red (B) (CHAPTER) to select Chapter Thumbnail screen.
- 5 Press ▲/▼/◀/▶ to select the chapter to combine, then press Yellow (D) (EDIT MENU).

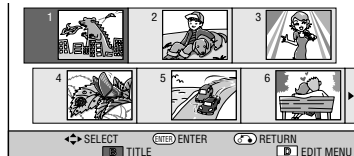

- 6 Press SET/ENTER.
- 7 Press ▲/▼ to select combine procedure you prefer, then press SET/ENTER.
 - Select from: "COMBINE W/PREV", "COMBINE W/NEXT" or "DON'T COMBINE".
 - If you select "COMBINE W/PREV" or "COMBINE W/NEXT", the two chapters will join, and the Chapter Thumbnail screen is displayed.
 - If you select "DON'T COMBINE", the previous screen displays.

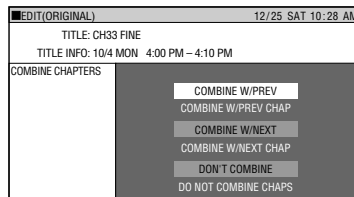

- 8 Press EXIT to exit from Edit mode.

Disabling Title Edit and Erase (TITLE PROTECT)

DVD-RW
VR MODE

Disables edit and erases so you cannot mistakenly change or erase the content of a title.

Lets you safely save a disc for which editing is in progress.

- This operation will not work with Video mode discs.
- Titles created with Play List (page 68) cannot be protected.

- 1 Select "EDIT/ERASE" in START MENU screen, then press SET/ENTER.
- 2 Press ▲/▼ to select "TITLE PROTECT/OFF", then press SET/ENTER.
- 3 Press ▲/▼/◀/▶ to select the title to protect, then press SET/ENTER.
 - Each time the button is pressed, the setting toggles between "PROTECT" and "NOT PROTECT".

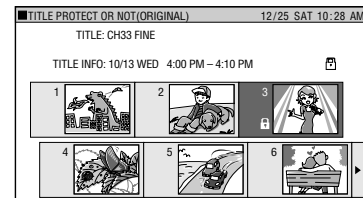

- The protect mark is attached to protected titles. (The protect mark can be confirmed at either the "REC LIST" screen or "EDIT" screen.)

- 4 Press EXIT to exit from Edit mode.

To Cancel Title Protect

- 1 Select the title protected in step 3 above, and press SET/ENTER.
 - Title protect is canceled, and the protect mark disappears.

NOTE

- If "DVD DISC PROTECTION" is set for a DVD-RW (VR mode) disc, protection cannot be canceled for individual titles. Cancel "DVD DISC PROTECTION" (page 82).

- 2 Press EXIT to exit from Edit mode.

Editing an Original Title

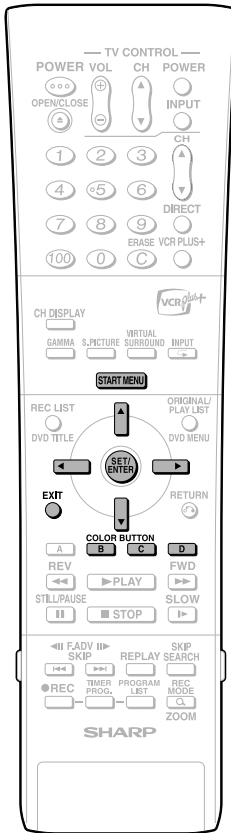

Erasing All Titles

DVD-RW | **DVD-RW** | **DVD-R**
VR MODE VIDEO MODE

This erases the entire contents of a DVD-RW. (Except titles for which title protect has been set.)

You can erase the following:

- **ORIGINAL:**
Erases all titles recorded on DVD. When originals are erased, play lists are also erased.
- **PLAY LIST:**
Erases all play lists created on DVD. Even if play lists are erased, the original titles are not erased.

NOTE

- When a Video mode disc is finalized, you can no longer erase all titles.

1 Select "EDIT/ERASE" in START MENU screen, then press **SET/ENTER**.

2 Press **▲/▼** to select "ERASE ALL TITLES", then press **SET/ENTER**.

3 Press **▲/▼** to select what you want to erase, then press **SET/ENTER**.

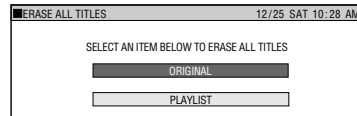

4 Press **◀/▶** to select "YES", then press **SET/ENTER**.

- Carefully confirm before executing erase.
- If you select "NO" and enter, the screen in step **3** appears.

5 Press **SET/ENTER**.

- All titles (or play lists) are erased, and the screen in step **3** appears. To restore the erased content, press **Green (C)** (CNL ERSE). Operate according to the instructions on the screen. (Note: You can only undo once, to the state immediately before the last erase.)

6 Press **EXIT** to exit from Edit mode.

Erasing by Selecting a Title (or Chapter)

DVD-RW | **DVD-RW** | **DVD-R**
VR MODE VIDEO MODE

Allows you to select titles to erase, and erase them in a batch.

- **When erasing original titles:**
If original titles are erased, those titles will also be erased from play lists.
- **When erasing play lists:**
Even if play lists are erased, the original titles will not be erased.

NOTE

- Up to a maximum of 20 titles (chapters) can be selected at one time.
- When a Video mode disc is finalized, you can no longer select and erase titles.
- You cannot erase chapters in DVD-RW/R discs (Video mode).

1 Select "EDIT/ERASE" in START MENU screen, then press **SET/ENTER**.

2 Press **▲/▼** to select "ERASE TITLES", then press **SET/ENTER**.

3 Press **▲/▼/◀/▶** to select titles to erase.

- If you press **Red (B)** (CHAPTER), the screen will switch to the chapter thumbnail display so you can select and erase chapters.

4 Press **SET/ENTER**.

- If there are other titles (chapters) you wish to erase, select with **▲/▼/◀/▶** and press **SET/ENTER**.

5 Press **Yellow (D)** (ERASE).

6 Press **◀/▶** to select "YES".

- Once a title (chapter) has been erased, it cannot be restored. Carefully confirm before executing erase.
- If you select "NO" and enter, operate from step **4** again.

7 Press **SET/ENTER**.

- All selected titles (chapters) are erased.
- To cancel erase, press **Green (C)** (CNL ERSE).
- Operate according to the instructions on the screen.

8 Press **EXIT** to exit from Edit mode.

Continued on Next Page ▶▶▶

Editing a Play List

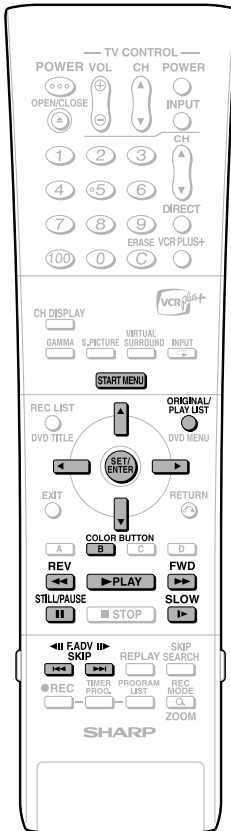

Creating a Play List

DVD-RW
VR MODE

You can create a Play List by copying a title or chapter units from an original. Also you can select your favorite scenes from originals, and compile them into a Play List.

NOTE

- Operations like "COPY TITLE/CHAPTER" and "COPY SPECIFIED SCENE" do not actually copy the original titles. These operations merely write the information "make this original title a title in the play list". Therefore, you can edit without decreasing free space in the disc or touching the original titles.
- When creating a play list from original titles, the original title's thumbnail and chapter mark information are not copied.

Creating from Original Titles

Makes a single original title into a play list title.

- 1 Select "EDIT/ERASE" in START MENU screen, then press SET/ENTER.**
- 2 Press ▲/▼ to select "EDIT", then press SET/ENTER.**
- 3 Press ORIGINAL/PLAY LIST to switch to the PLAY LIST screen.**
 - The screen switches to the Play List Edit Screen.
 - There still is no title at this point, so a "NEW" title frame with no image is displayed.
 - To create a new Play List later, select the "NEW" title frame.

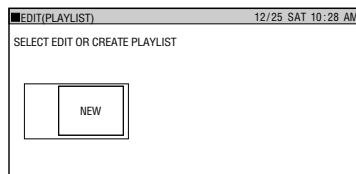

- 4 Press SET/ENTER.**

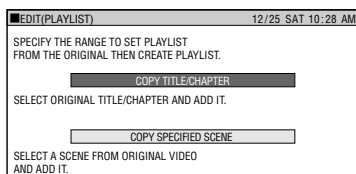

- 5**
 - 1 Press ▲/▼ to select "COPY TITLE/CHAPTER".**
 - 2 Press SET/ENTER.**
 - REC LIST (Thumbnail) screen of the original appears.

- 6**
 - 1 Press ▲/▼/◀/▶ to select title to copy.**

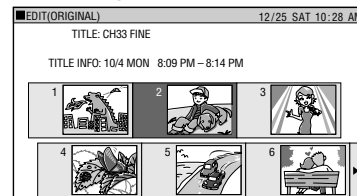

- To select a chapter, press **Red (B)** (CHAPTER).
- 2 Press SET/ENTER.**
 - The selected title (chapter) becomes a Play List title.

Creating from Part of an Original

You can select a desired scene from an original title, and make it into a Play List title.

- 1 Perform steps 1-4 of "Creating from Original Titles" in the left column.**
- 2**
 - 1 Press ▲/▼ to select "COPY SPECIFIED SCENE".**
 - 2 Press SET/ENTER.**
- 3 Press ▲/▼/◀/▶ to select title to copy, then press SET/ENTER.**
 - To select from a chapter, press **Red (B)** (CHAPTER) and select the chapter.
- 4 Press ►PLAY to start playback.**
 - Find the scene to copy using **|| STILL/PAUSE**, **►► FWD**, **◀◀ REW**, **◀◀◀**, **▶▶▶**, or **► SLOW**.
- 5 Press SET/ENTER at the place where you want to start copying.**

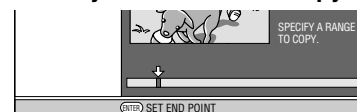

- If you fast reverse to a scene prior to the start point, the start point will be canceled.
- When the start point is set to near the beginning of a chapter, the beginning of the chapter will be selected as the start point. To make the original designated start point effective, set it again after combining the chapter with the one immediately before (page 66).

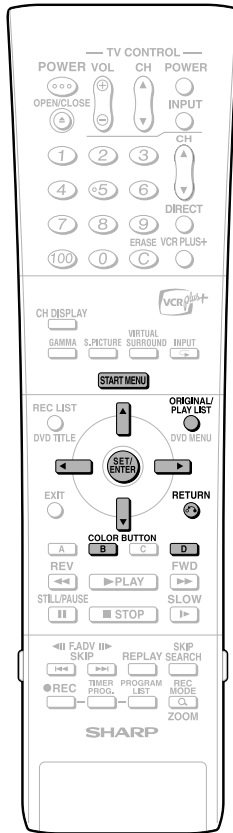

6 Find the place where you want to end copying, then press **SET/ENTER**.

- If you press **RETURN**, you can reselect the start point.



- When the end point is set to near the end of a chapter, the end of the chapter will be selected as the end point. To make the original designated end point effective, set it again after combining the chapter with the next chapter (page 66).

7 Press Red (B) (CONFIRMING) to confirm the content. Press Yellow (D) (CREATE) to execute copy. Go to step 8.

- You can reselect the end point by pressing **RETURN**.

8 ① Press **◀/▶** to select "YES". ② Press **SET/ENTER**.



- One play list title is created.

NOTE

Selecting start or end point to add a scene.

- You cannot add a scene which is less than 3 seconds.

Adding a Scene from an Original to a Play List (ADD SCENE)

DVD-RW
VR MODE

Adds video selected from an original to the end of play list titles.

NOTE

- The selected scene cannot be added if adding it will make the title longer than 12 hours.
- Scenes can be added as long as the length of the title after adding is less than the maximum of 12 hours.

1 Select "EDIT/ERASE" in START MENU screen, then press **SET/ENTER**.

2 Press **▲/▼** to select "EDIT", then press **SET/ENTER**.

3 ① Press **ORIGINAL/PLAY LIST** to switch to Play List screen. ② Press **▲/▼/◀/▶** to select title to edit.

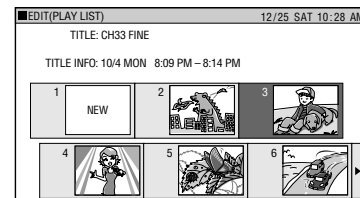

③ Press **Yellow (D) (EDIT MENU)**.

4 Press **▲/▼** to select "ADD SCENE" then press **SET/ENTER**.

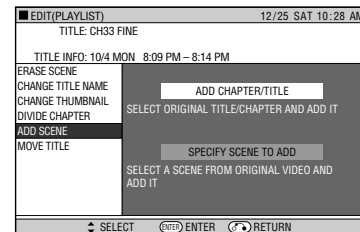

Continued on Next Page ▶▶▶

Editing a Play List

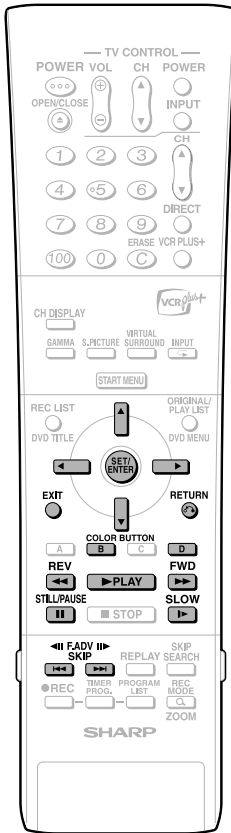

5 Adding a Title or Chapter

- ① Select “ADD CHAPTER/TITLE”, then press **SET/ENTER**.
- ② Select a title (chapter) at the title (chapter) list, then press **SET/ENTER**.
Go to step 9.

Specifying and Adding a Scene

- Select “SPECIFY SCENE TO ADD”, then press **SET/ENTER**.
Go to step 6.

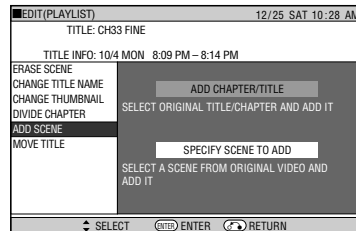

6 Press ▲/▼/◀/▶ to select title (chapter) to edit, then press **SET/ENTER**.

- The selected title (chapter) pauses.

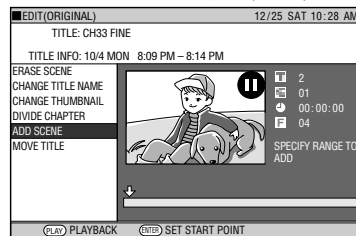

7 ① Press **▶PLAY** to start playback.

- Find the scene to add using **||STILL/PAUSE**, **▶▶FWD**, **◀◀REV**, **◀◀◀**, **▶▶▶**, or **▶SLOW**.

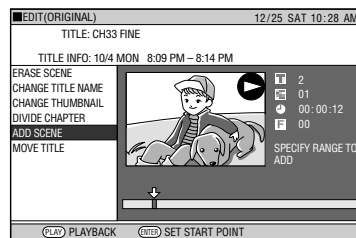

② Press **SET/ENTER** at the start point of the scene you want to add.

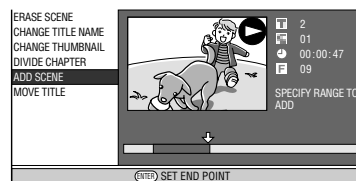

- If you fast reverse to a scene prior to the start point, the start point will be canceled.
- When the start point is set to near the beginning of a chapter, the beginning of the chapter will be selected as the start point. To make the original designated start point effective, set it again after combining the chapter with the one immediately before (page 66).

8 Press **SET/ENTER** at the end of the scene you want to add.



- Press **RETURN** to reselect the start point of the scene. You can press **RETURN** to reselect the end point even after it is already set.
- When the end point is set to near the end of a chapter, the end of the chapter will be selected as the end point. To make the original designated end point effective, set it again after combining the chapter with the next chapter (page 66).

9 Press **Red (B) (CONFIRMING)** to confirm the content. Press **Yellow (D) (ADD)** to add.

- If you press **Red (B) (CONFIRMING)**, you can test play the added scene, from the start point to the end point. It may take about one minute for the confirm screen to appear.
- Press **Yellow (D) (ADD)** to add.

10 ① Press **◀/▶** to select “YES”. ② Press **SET/ENTER**.

- The scene is added after the selected title, and stored as a new title of the play list.

11 Press **EXIT** to exit from EDIT mode.

- A chapter mark is automatically set at the start point where the scene is added.

NOTE

- When adding a scene, select a scene which continues for at least 3 seconds. Scenes shorter than 3 seconds cannot be added.
- Scenes can only be added and erased a maximum of 50 times per title.
- If you press **◀◀REV** or **◀◀◀** and reverse beyond the start point after setting a start point, the start point will cancel.
- If scenes have been added or erased 51 or more times to a single title in a disc using another DVD recorder, Editing (Recording) may not function.

Editing a Play List

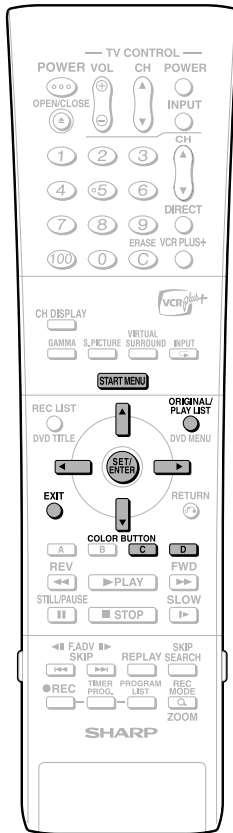

Changing the Title Sequence (MOVE TITLE)

DVD-RW
VR MODE

Freely changes the sequence of titles.

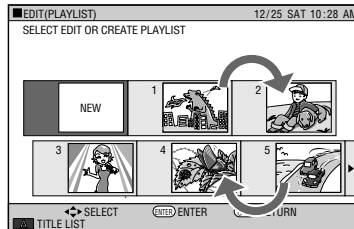

- 1** Select "EDIT/ERASE" in START MENU screen, then press **SET/ENTER**.
- 2** Press **▲/▼** to select "EDIT", then press **SET/ENTER**.
- 3**
 - ① Press **ORIGINAL/PLAY LIST** to switch to Play List screen.
 - ② Press **▲/▼/◀▶** to select title to edit.

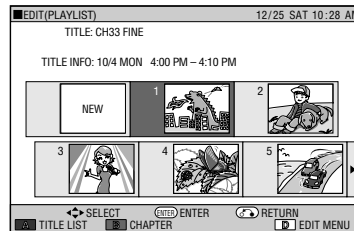

- ③ Press **Yellow (D) (EDIT MENU)**.
- 4** Press **▲/▼** to select "MOVE TITLE", then press **SET/ENTER**.
- 5** Press **▲/▼/◀▶** to select the thumbnail to move the title to.



Selected title

Cursor on the thumbnail to move the selected title to

6 Press **SET/ENTER**.

- If a point prior to the selected title is selected as the destination, the title will move to the point immediately prior to the selected title.
- Press **Green (C) (UNDO)** to restore to the state before the movement. Operate according to the instructions on the screen.

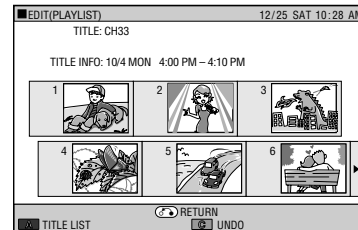
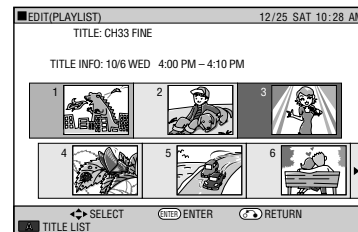

Example: If Title 3 is selected and the destination cursor is set to Title 1, Title 3 is moved to the spot in front of Title 1.

- If a point after the selected title is selected as the destination, the title will move to the point immediately after the selected title.

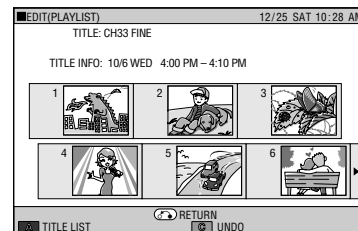

Example: If Title 3 is selected and the destination cursor is set to Title 4, Title 3 is moved to the spot after Title 4.

7 Press **EXIT** to exit from EDIT mode.

Editing a Play List

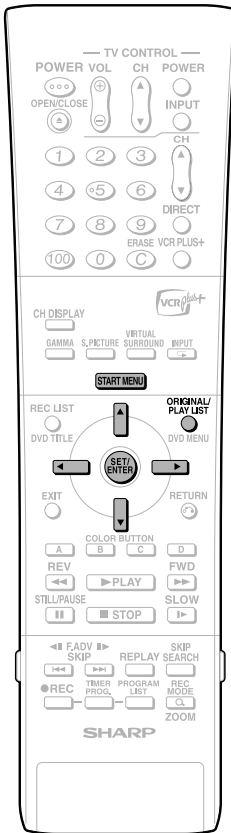

Erasing Unnecessary Scenes (ERASE SCENE)

DVD-RW
VR MODE

Selects and erases unnecessary scenes. Even if you erase a scene in a play list, this will not affect the original video.

- 1** Select "EDIT" at the "EDIT/ERASE" in START MENU, then press **SET/ENTER**.
 - The Thumbnail screen appears.
- 2** Press **ORIGINAL/PLAY LIST** to display Play List (Thumbnail) screen.
- 3** Erase the scene using the same operation used for erasing an original scene (step 4 on page 60-step 11 on page 61).

Inputting/Changing Title Name (CHANGE TITLE NAME)

DVD-RW
VR MODE

You can input up to 64 characters.

- 1** Select "EDIT" at the "EDIT/ERASE" in START MENU, then press **SET/ENTER**.
 - The Thumbnail screen appears.
- 2** Press **ORIGINAL/PLAY LIST** to display Play List (Thumbnail) screen.
- 3** Change or input the title name using the same operation used for changing or inputting an original title (steps 4 - 8 on page 62).

Changing Thumbnail (CHANGE THUMBNAIL)

DVD-RW
VR MODE

Changes the image of title displayed in REC LIST to a scene you like in the title.

- 1** Select "EDIT" at the "EDIT/ERASE" in START MENU, then press **SET/ENTER**.
 - The Thumbnail screen appears.
- 2** Press **ORIGINAL/PLAY LIST** to display Play List (Thumbnail) screen.
- 3** Change the thumbnail using the same operation used for changing an original thumbnail (steps 4 - 9 on page 64).

Making Sections in a Title (DIVIDE CHAPTER)

DVD-RW
VR MODE

Divides a title into multiple chapters. This makes editing and dubbing in chapter units more convenient.

- 1** Select "EDIT" at the "EDIT/ERASE" in START MENU, then press **SET/ENTER**.
 - The Thumbnail screen appears.
- 2** Press **ORIGINAL/PLAY LIST** to display Play List (Thumbnail) screen.
- 3** Divide a title into chapters using the same operation used for chapter division of originals (steps 4 - 9 on page 65).

Combining Chapters Together (COMBINE CHAPTERS)

DVD-RW
VR MODE

This lets you combine two adjacent chapters into a single chapter.

- 1** Select "EDIT" at the "EDIT/ERASE" in START MENU, then press **SET/ENTER**.
 - The Thumbnail screen appears.
- 2** Press **ORIGINAL/PLAY LIST** to display Play List (Thumbnail) screen.
- 3** Combine chapters using the same operation used for chapter combination of originals (steps 3-8, left column on page 66).

NOTE

- You cannot combine chapters automatically recorded when a scene was erased, or chapters recorded due to adding a scene to a play list (with ADD SCENE).

Enjoying High Quality Sounds

Playing 2 Channel Audio with an Analog Connection

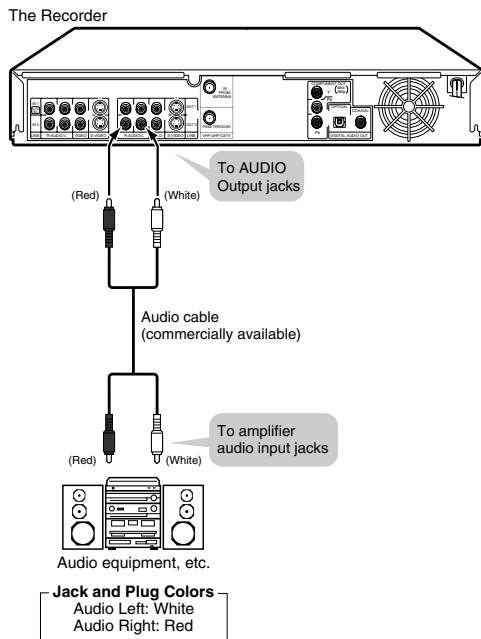

NOTE

- When connecting audio equipment using analog connection, we recommend that you set "DD OUTPUT LEVEL" to "NO" (see page 81). If you set to "YES", audio may sound abnormal during disc playback.

Playing Dolby Digital (5.1 Channel) and DTS Audio with a Digital Connection

- Connecting an amplifier with a Dolby Digital/DTS digital surround processor or a Dolby Digital/DTS digital surround amplifier to the Recorder's coaxial or optical DIGITAL AUDIO Output jack (terminal) provides richer, more powerful audio play.
- To enjoy DTS Digital Surround audio, select DTS audio at the disc menu during DVD playback, or select DTS audio using the AUDIO button (under the cover) of the remote control.

■ Connection to a processor or amplifier with an optical or coaxial digital input jack (terminal)

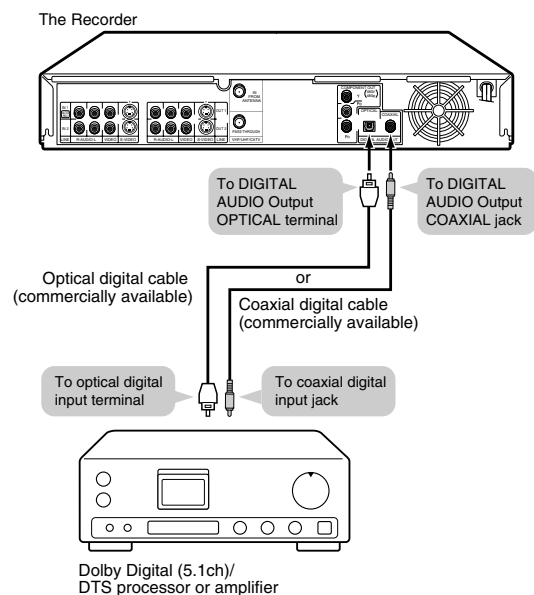

! Important!

- When using this connection, set "DIGITAL AUDIO OUTPUT" to "Dolby Digital" (see page 80).

NOTE

- To play a disc recorded with DTS, you need to use DTS processor or amplifier.
- This connection is not possible if the processor or amplifier to which you want to connect does not have an optical or coaxial digital input jack (terminal).
- Refer to the operation manual for the processor or amplifier for information about connecting to it.

Enjoying High Quality Sounds

Playing 2 Channel Audio with a Digital Connection

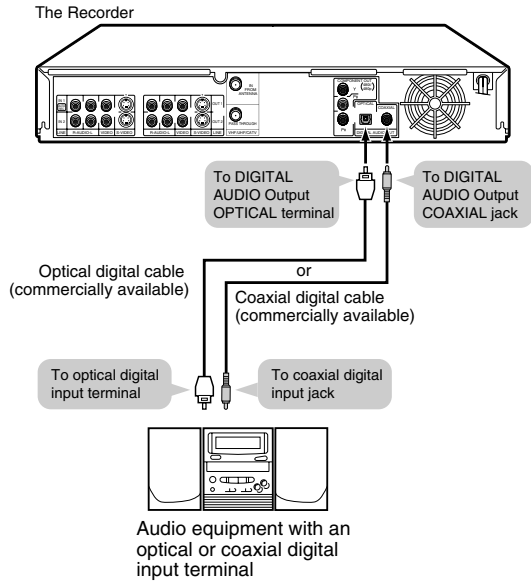

Digital Connection to an MD Recorder or Other Audio Equipment without a Dolby Digital Decoder

Audio CD or Video CD

- You can enjoy these discs by playing them back by the ordinary playback procedure. (The normal audio output is not played back for discs recorded with DTS.)

DVD Video Disc

- There is no audio signal generated for DVD video discs recorded with DTS. A processor or amplifier equipped with a DTS Surround decoder function is required to enjoy DTS audio.

! Important!

- When using this connection, set "DIGITAL AUDIO OUTPUT" to "PCM" (see page 80).

Digital Connection to an MD Recorder to Record a CD

- When you are using a digital connection to record the contents of a CD to an MD, the track numbers of the CD may not match the track numbers recorded to the MD.

Recording from External Equipment

Recording from a Camcorder (VCR) Using an Analog Connection

DVD-RW | DVD-RW | DVD-R
VR MODE | VIDEO MODE

Material from a camcorder can be recorded with this Recorder using an analog connection. You can capture video by connecting a camcorder or VCR to the LINE IN 1, 2 or 3 jacks of this Recorder.

NOTE

- More vivid images can be viewed by connecting the S-VIDEO IN jack on this Recorder with the S-video Out jack on the camcorder using an S-video cable.
- Some camcorders may be required to be connected using a special cable.
- Refer to the operation manual provided with the camcorder for further information on the procedure for connecting the camcorder.
- Material protected with a copy guard cannot be recorded. It may be impossible to get the correct video, even if you just view without recording.
- Date and time as well as the contents of cassette memory cannot be recorded with this Recorder.
- If you input video from an external device to this Recorder, there will be a slight difference in image quality between the video viewed from the external device directly on the TV, and video viewed as external input to the Recorder.

Example:

To record by connecting a camcorder to the LINE IN 3 jacks.

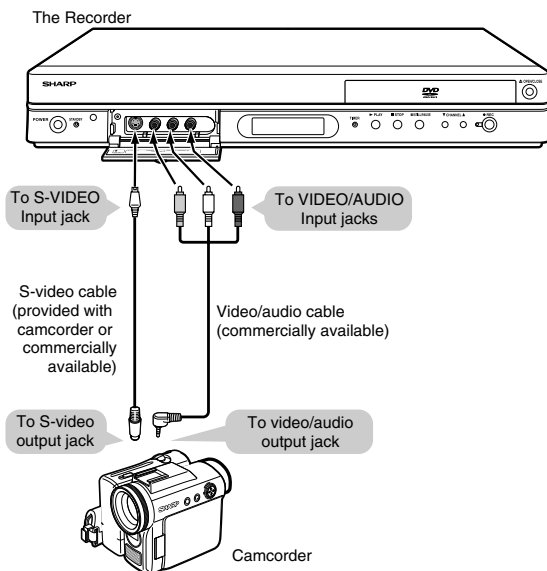

1 Select audio to be input from the external equipment.

- Select audio using "EXTERNAL AUDIO" (page 76).
- Select "L CH" or "R CH" with "DUAL MONO REC. SET" (page 76) to record in Video mode.

2 Press INPUT to set the connection to external input channel (example: L3).

- The setting will cycle as follows each time you press the button.

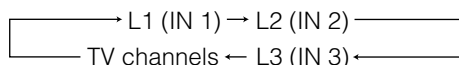

3 Play back the camcorder or VCR.

4 Press ●REC when you reach the scene you want to start recording.

- The Recorder starts recording.

5 Press ■STILL/PAUSE when you want to pause recording.

- Press ■STILL/PAUSE again to cancel Pause mode.

6 Press ■STOP when you want to stop (end) recording.

Function Setting

Settings of This Recorder

This section explains various settings relating to recording and playback which can be used to get more out of the Recorder.

- For details about each setting, see the corresponding pages.

REC. FUNCTION → page 76

VIEW/PLAY SETTING → page 78

ADJUSTMENT → page 80

INITIALIZE/FINALIZE → page 84

| REC. FUNCTION | |
|---|---|
| <p>AUTO CHAPTER</p> <ul style="list-style-type: none"> • This sets the interval of automatic chapter setting during recording. • Chapter marks set on a DVD in Video mode cannot be combined by editing, so select an appropriate interval. | 10 (10 min interval) 15 (15 min interval) 30 (30 min interval) - - (off) |
| <p>EXACT RECORDING</p> <ul style="list-style-type: none"> • This function works when timer recording (Easy Recording Guide/VCR Plus+/Timer Program) onto DVD-RW/R. If disc capacity runs low, and the program cannot be recorded to the end, this function will automatically change the recording mode so the program will fit. (The recording mode set in above situation will have lower picture quality than the originally set recording mode.) • If there is very little disc capacity left on the disc, the program may not fit even if Exact Recording is set. • When recording in EP mode, there is no lower recording mode, so Exact Recording will not work. | YES NO |
| <p>REC. AUDIO FORMAT</p> <ul style="list-style-type: none"> • PCM: If you record by setting the recording mode to "FINE" or "MN32", you can record audio as PCM (uncompressed) audio which can be played back with 2ch audio equipment. * This will not work when recording with the recording mode set to anything other than "FINE" or "MN32". * Recording is done with a recording mode whose image quality is slightly lower than FINE mode recorded with the "DD 2CH" setting. • DD 2CH: Records audio as Dolby Digital 2ch audio. | PCM DD 2CH |
| <p>EXTERNAL AUDIO</p> <ul style="list-style-type: none"> • This selects audio to be input from an external equipment. STEREO: Recording standard stereo sound. DUAL MONO: Recording the sound that each channel carries as a separate sound. | STEREO DUAL MONO |
| <p>DUAL MONO REC. SET</p> <ul style="list-style-type: none"> • This lets you select whether to record the left or right audio channel when recording an external source onto DVD-RW/R in Video mode. | L CH R CH |
| <p>MANUAL REC. MODE</p> <ul style="list-style-type: none"> • If you set by selecting one of the 32 picture quality levels for "MN", recording will be done at that picture quality when "MN" is selected using REC MODE on the remote control. For details, see page 36. | 32 levels |
| <p>SAP SETTING</p> <ul style="list-style-type: none"> • If you set this to "ON" while receiving a SAP (Separate Audio Program) broadcast, you can listen to and record the SAP audio. For details on ON/OFF setting, the audio you can listen to, and the audio you can record, see "About SAP" on page 77. | ON OFF |

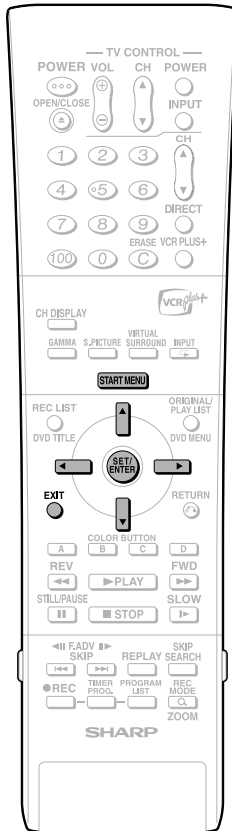

Basic Operation for REC FUNCTION Setting

Example: Setting "EXTERNAL AUDIO" under "REC. FUNCTION"

- 1** ① Press **START MENU** to display **START MENU** screen.
- ② Press **▲/▼/◀/▶** to select "**OTHER SETTINGS**", then press **SET/ENTER**.

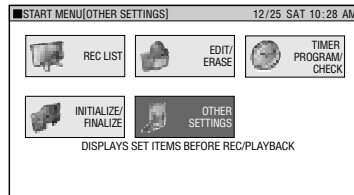

- 2** Press **◀/▶** to select "**REC. FUNCTION**".

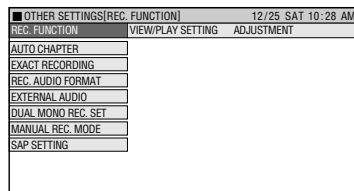

- 3** Press **▲/▼** to select "**EXTERNAL AUDIO**", then press **SET/ENTER**.

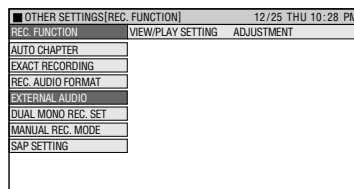

- 4** Press **◀/▶** to select the option you want to set, then press **SET/ENTER**.

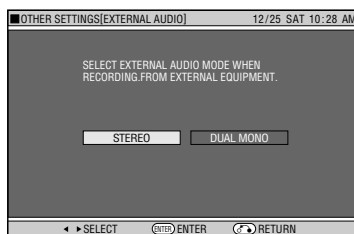

- 5** Press **EXIT** to exit from External Audio Setting.

About SAP

This Recorder can record stereo or SAP (Separate Audio Program) broadcasts, where available. If the broadcast is in stereo, the Recorder automatically records the stereo sound. If the broadcast is in SAP, you can record both the MAIN and the SAP sounds. If the broadcast is in stereo/SAP, you can record either the SAP sound by setting the SAP mode to "ON", or stereo sound by setting the SAP mode to "OFF".

SAP Broadcast

The monitor output listed in the table shows the audio output mode. The contents of audio recording are different between VR mode and Video mode. See the table below for details.

| Broadcast Received/SAP ON or OFF | AUDIO Mode | Recording | | AUDIO OUTPUT | |
|----------------------------------|------------|-----------|------|--------------|------|
| | | L | R | L | R |
| STEREO+SAP | MONO | L+R | L+R | L+R | L+R |
| SAP OFF | L R | L | R | L | R |
| STEREO+SAP | MAIN | L+R | L+R | L+R | L+R |
| SAP ON | SAP | L+R | SAP | SAP | SAP |
| STEREO | MONO | L+R | L+R | L+R | L+R |
| SAP OFF | L R | L | R | L | R |
| STEREO | MONO | L+R | L+R | L+R | L+R |
| SAP ON | L R | L | R | L | R |
| MONO+SAP | MONO | MONO | MONO | MONO | MONO |
| SAP OFF | L R | MONO | MONO | MONO | MONO |
| MONO+SAP | MAIN | MONO | MONO | MONO | MONO |
| SAP ON | SAP | MONO | SAP | SAP | SAP |
| MONO | MONO | MONO | MONO | MONO | MONO |
| SAP OFF | L R | MONO | MONO | MONO | MONO |
| MONO | MONO | MONO | MONO | MONO | MONO |
| SAP ON | L R | MONO | MONO | MONO | MONO |

□: When recording to a DVD-RW/R disc in Video mode, the SAP channel is recorded on this channel.

When recording audio in the PCM format with the recording mode set to "FINE" or "MN32", audio is recorded in the same format as recorded to DVD-RW/R disc in Video mode.

- When a disc recorded in monaural audio is played back, monaural audio is played back even though "STEREO" is displayed on the screen.

Continued on Next Page ▶▶▶

Function Setting

VIEW/PLAY SETTING

| | | |
|-------------------------|---|--|
| PASSWORD SETTING | PASSWORD <ul style="list-style-type: none"> This sets the password for setting or changing Parental Control. | 4 digit number |
| DVD PLAY SETTING | PARENTAL CONTROL <ul style="list-style-type: none"> This lets you set Parental Control depending on disc content. Level 1: For most restricted viewing → Level 8: For adult viewing (The smaller the number, the greater the level of restriction.) When "PARENTAL CONTROL" is set to "OFF", DVD discs can be played back regardless of the parental level. The parental level for USA is as follows. Level 7: NC-17 Level 6: R Level 4: PG13 Level 3: PG Level 1: G The parental level set up for Canada is prepared for future use. As for the set up of an appropriate level, please check the level when you purchase your DVD disc equipped with the parental control feature. Parental Control cannot be set if a password has not been set. | OFF, LEVEL 1-8 COUNTRY CODE * Refer to the Country Code List below. |
| | DISC LANGUAGE <ul style="list-style-type: none"> This lets you select the language for audio and menus displayed on the screen. | SUBTITLE AUDIO MENU * Refer to the Language Code List below. |

Country Code List

| | | | | |
|---------|--------|---------|-----------|------------|
| USA | UK | HOLLAND | HONG KONG | TAIWAN |
| CANADA | ITALY | NORWAY | SINGAPORE | PHILIPPINE |
| JAPAN | SPAIN | DENMARK | THAILAND | AUSTRALIA |
| GERMANY | SWISS | FINLAND | MALAYSIA | RUSSIA |
| FRANCE | SWEDEN | BELGIUM | INDONESIA | CHINA |

Language Code List

| | | | | |
|--------------------|-----------------|---------------------|-------------------|---------------|
| AA Afar | EU Basque | KK Kazakh | OM Afan (Oromo) | SW Swahili |
| AB Abkhazian | FA Persian | KL Greenlandic | OR Oriya | TA Tamil |
| AF Afrikaans | FI Finnish | KM Cambodian | PA Panjabi | TE Telugu |
| AM Ameharic | FJ Fiji | KN Kannada | PL Polish | TG Tajik |
| AR Arabic | FO Faroese | KO Korean | PS Pashto, Pushto | TH Thai |
| AS Assamese | FR French | KS Kashmiri | PT Portuguese | TI Tigrinya |
| AY Aymara | FY Frisian | KU Kurdish | QU Quechua | TK Turkmen |
| AZ Azerbaijani | GA Irish | KY Kirghiz | RM Rhaeto-Romance | TL Tagalog |
| BA Bashkir | GD Scots Gaelic | LA Latin | RN Kirundi | TN Setswana |
| BE Byelorussian | GL Galician | LN Lingala | RO Romanian | TO Tonga |
| BG Bulgarian | GN Guarani | LO Laothian | RU Russian | TR Turkish |
| BH Bihari | GU Gujarati | LT Lithuanian | RW Kinyarwanda | TS Tsonga |
| BI Bislama | HA Hausa | LV Latvian, Lettish | SA Sanskrit | TT Tatar |
| BN Bengali, Bangla | HI Hindi | MG Malagasy | SD Sindhi | TW Twi |
| BO Tibetan | HR Croatian | MI Maori | SG Sangho | UK Ukrainian |
| BR Breton | HU Hungarian | MK Macedonian | SH Serbo-Croatian | UR Urdu |
| CA Catalan | HY Armenian | ML Malayalam | SI Singhalese | UZ Uzbek |
| CO Corsican | IA Interlingua | MN Mongolian | SK Slovak | VI Vietnamese |
| CS Czech | IE Interlingue | MO Moldavian | SL Slovenian | VO Volapük |
| CY Welsh | IK Inupiak | MR Marathi | SM Samoan | WO Wolof |
| DA Danish | IN Indonesian | MS Malay | SN Shona | XH Xhosa |
| DE German | IS Icelandic | MT Maltese | SO Somali | YO Yoruba |
| DZ Bhutani | IT Italian | MY Burmese | SQ Albanian | ZH Chinese |
| EL Greek | IW Hebrew | NA Nauru | SR Serbian | ZU Zulu |
| EN English | JA Japanese | NE Nepali | SS Siswat | |
| EO Esperanto | JL Yiddish | NL Dutch | ST Sesotho | |
| ES Spanish | JW Javanese | NO Norwegian | SU Sundanese | |
| ET Estonian | KA Georgian | OC Occitan | SV Swedish | |

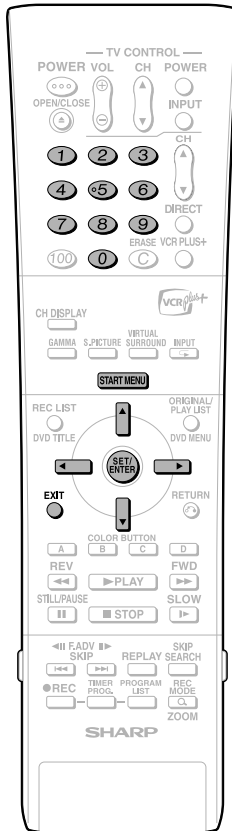

Basic Operation for VIEW/PLAY SETTING

Example: Setting "DVD PLAY SETTING" under "VIEW/PLAY SETTING"

- 1** Press **START MENU** to display **START MENU** screen.
- 2** Press **▲/▼/◀/▶** to select "**OTHER SETTINGS**", then press **SET/ENTER**.

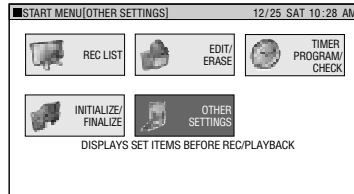

- 2** Press **◀/▶** to select "**VIEW/PLAY SETTING**", then press **SET/ENTER**.

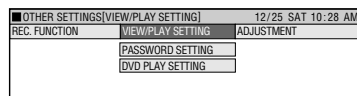

- 3** Press **▲/▼** to select "**DVD PLAY SETTING**", then press **SET/ENTER**.

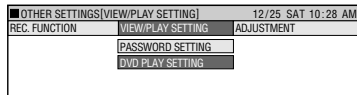

- 4** Press **▲/▼** to select "**PARENTAL CONTROL**", then press **SET/ENTER**.

- The password input screen appears. It changes to the following screen after you input your password and press **SET/ENTER**.

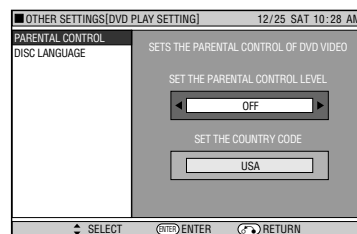

- 5** Press **◀/▶** to select the desired parental control level, then press **SET/ENTER**.
- 6** Press **◀/▶** to select the country code, then press **SET/ENTER**.
- 7** Press **EXIT** to exit from Parental Control Setting screen.

Password Setting

- 1** Select "**PASSWORD SETTING**" in step **3**, then press **SET/ENTER**.
- 2** Press **◀/▶** to select "**YES**", then press **SET/ENTER**.
- 3** Press **Number** buttons to input 4 digit password, then press **SET/ENTER**.
- 4** Press **Number** buttons to input password for confirmation, then press **SET/ENTER**.
- 5** Press **SET/ENTER** at the "**OK**" screen.

NOTE

If you forget your password

- If you forget your password, and you wish to return the password to its initial state, press **STOP** 4 times in a row at the Password Setting screen.

Disc Language Setting

- You can set subtitle language, audio language and menu language.

- 1** Select "**DISC LANGUAGE**" in step **4**, then press **SET/ENTER**.
- 2** Press **◀/▶** to select subtitle language, then press **SET/ENTER**.
- 3** Press **◀/▶** to select audio language, then press **SET/ENTER**.
- 4** Press **◀/▶** to select menu language, then press **SET/ENTER**.

Continued on Next Page ▶▶▶

Function Setting

| ADJUSTMENT | | |
|----------------------------|---|--|
| CLOCK SETTING | <p>AUTO SETTING/MANUAL SETTING</p> <ul style="list-style-type: none"> • Before timer programming, check that the clock is set correctly, and set it correctly if it is not. If the clock is not set correctly, you cannot perform setting for features like VCR Plus+ programming. • Setting methods are slightly different from basic operation. See page 29. | AUTO SETTING AUTO MANUAL TIME ZONE MANUAL SETTING TIME: XX:XX DATE: Month/Day YEAR: XXXX DST: ON/OFF |
| VIDEO/AUDIO SETTING | <p>TV MODE</p> <ul style="list-style-type: none"> • If you switch your TV (i.e. because you have bought a new one) and the screen size of the connected TV changes, you will have to change the "TV MODE" setting. • You can set the screen aspect ratio of the connected TV, and adjust video output. • Select "TV MODE" from "VIDEO/AUDIO SETTING". <p>WIDE 16:9: Select this when connecting with a TV with a 16:9 screen aspect ratio.</p> <p>NORMAL 4:3: Select this when connecting with a TV with a 4:3 screen aspect ratio.</p> <p>LETTER BOX: If you connect with a TV whose screen aspect ratio is 4:3 and play back a DVD with 16:9 video, the video will be played back with black bands at the top and bottom, while maintaining the 16:9 ratio.</p> <p>PAN SCAN: If you connect with a TV whose screen aspect ratio is 4:3 and play back a DVD with 16:9 video, the video will be played back with the left and right sides of the image cut off to display in 4:3 screen aspect ratio. (This function works if the disc is labeled for 4:3PS.)</p> | WIDE 16:9 NORMAL 4:3 LETTER BOX PAN SCAN |
| | <p>CONNECTING TERMINAL</p> <ul style="list-style-type: none"> • If you switch your TV (i.e. because you have bought a new one) and you change the TV terminal to which you connect, you will have to change the "CONNECTING TERMINAL" setting. • For details on connection with a TV, and connecting terminals, please see pages 21 to 24. • "PROGRESSIVE OUT" can be set when you have selected "COMPONENT". | VIDEO/S-VIDEO COMPONENT |
| | <p>PROGRESSIVE OUT</p> <ul style="list-style-type: none"> • If you connect with the component terminal of a progressive compatible TV, playback of DVD video will be cleaner, with less flicker. • If you connect with a TV which is not progressive compatible, select "PROGRESSIVE SCAN OFF". * If you connect with a TV which is not progressive compatible and set to "PROGRESSIVE SCAN ON", video playback from the DVD will not be output to the TV. | PROGRESSIVE SCAN ON PROGRESSIVE SCAN OFF |
| | <p>DIGITAL AUDIO OUTPUT</p> <ul style="list-style-type: none"> • You can set this to enjoy Dolby Digital Surround when connecting with digital input compatible device using Digital cable. <p>PCM: This setting is for when you digitally connect with 2ch audio device or an MD recorder. This changes Dolby Digital audio to PCM (uncompressed) output which can be played back with 2ch audio device.</p> <p>Dolby Digital: This setting is for when you digitally connect with audio device which is compatible with Dolby Digital (5.1ch). You can also enjoy DTS audio if you connect with an amplifier or other component which is compatible with DTS digital surround.</p> | PCM Dolby Digital |

| ADJUSTMENT | | |
|---------------------------------------|---|----------------|
| VIDEO/ AUDIO SET- TING | DD OUTPUT LEVEL <ul style="list-style-type: none"> This lets you adjust the range between the loudest and softest sound (dynamic range), and play back at the average volume. Use this when it is hard to hear dialog. <p>NO: This outputs recorded audio as is.</p> <p>YES*: This raises the average volume when playing back Dolby Digital audio so that the volume sounds the same as an audio CD. (If the audio sounds abnormal, set to "NO".)</p> <p>* Lower the volume before setting. If you do not do so, the speaker may emit a loud sound, or excessive input may be applied to the speaker.</p> | NO YES |
| | 3D Y/C SEPARATION <ul style="list-style-type: none"> This setting enables cleaner viewing and recording of TV broadcasts, and video from equipment connected to external input jacks (terminals). <p>YES: This enables recording with higher picture quality. (Normally this is set to "YES".)</p> <p>NO: Set this to "NO" if the picture looks abnormal when receiving a weak broadcast signal, or when the picture is disturbed because you have connected VCR or game equipment to the external input terminals of the Recorder.</p> | YES NO |
| | DNR (DIGITAL NOISE REDUCTION) <ul style="list-style-type: none"> This lets you reduce noise for an easier to view picture when noise in the played back image is bothering you. It is recommended to set this to "ON" when playing back video recorded in long play modes like LP mode or EP mode, and to "OFF" when playing back discs with little noise (like DVD video). | ON OFF |
| CHANNEL PRESET | SELECT RECEPTION TYPE <ul style="list-style-type: none"> This sets the type of TV broadcast received (AIR or CATV). | AIR CATV |
| | SELECT CHANNEL PRESET METHOD <ul style="list-style-type: none"> This sets whether to perform channel setting automatically or manually. | AUTO MANUAL |
| OPTION SETTING | SEAMLESS PLAYBACK <ul style="list-style-type: none"> This setting is for smoother playback of the transitions between scenes when you have edited an original title or play list. (The transition point may shift about one second.) | YES NO |

Function Setting

ADJUSTMENT

| | | |
|---------------------------|---|------------------------|
| OPTION SETTING | LCD BACKLIGHT REC. <ul style="list-style-type: none"> This sets whether to turn the LCD backlight on or off during timer recording. NO: This sets so that the LCD backlight remains lit, even during timer recording. YES: This lets you turn off the LCD backlight only when the power is off (standby state) and timer recording starts. It is convenient to set this, for example, when the light disturbs your sleep. | NO YES |
| | AUTO POWER OFF <ul style="list-style-type: none"> This sets the Recorder so that power is automatically shut off if it is in stopped state for about 3 hours. | YES NO |
| | BLUE SCREEN <ul style="list-style-type: none"> This lets you set so that noise on the TV screen is automatically switched to a blue screen if you select a channel whose broadcast is finished, or a channel with no broadcast. | OFF ON |
| | DVD DISC PROTECTION <ul style="list-style-type: none"> This protects the disc so you do not mistakenly record on it or erase its content. | NOT PROTECT PROTECT |

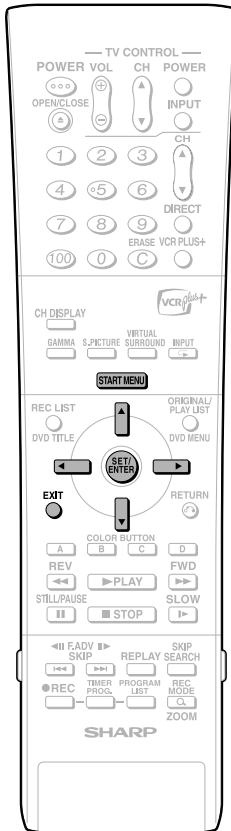

Basic Operation for ADJUSTMENT Setting

Example: Setting "VIDEO/AUDIO SETTING" under "ADJUSTMENT"

- 1** ① Press **START MENU** to display **START MENU** screen.
- ② Press **▲/▼/◀/▶** to select "**OTHER SETTINGS**", then press **SET/ENTER**.

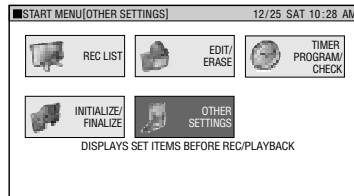

- 2** Press **◀/▶** to select "**ADJUSTMENT**".

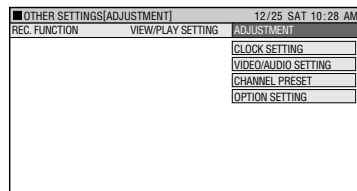

- 3** Press **▲/▼** to select the setting you want to set, then press **SET/ENTER**.

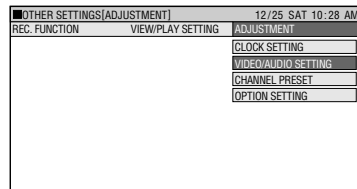

- 4** ① Press **▲/▼** to select the item you want to select, then press **SET/ENTER**.

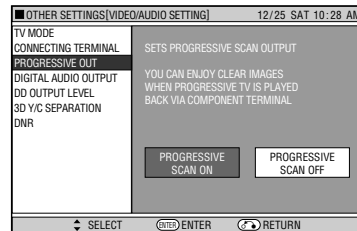

- ② Press **◀/▶** to select the desired option, then press **SET/ENTER**.

- 5** Press **EXIT** to exit.

Continued on Next Page ▶▶▶▶

Function Setting

Initialization

Before recording to DVD-RW, initialize the disc in VR mode or Video mode.

Finalization

Finalization is done so that a recorded DVD-RW/R can be played back with other recorders.

INITIALIZE

| | | |
|-------------------|--|-------------|
| INITIALIZE | VR MODE INIT. <ul style="list-style-type: none"> When recording with a DVD-RW in VR mode, initialize in VR mode before you start recording. (When you initialize, all of the recorded content of the disc is erased. Before initializing, check the content of the disc so that you do not erase any content you need.) You cannot initialize if "DVD DISC PROTECTION" is set to "PROTECT". (page 82) | YES NO |
| | VIDEO MODE INIT. <ul style="list-style-type: none"> When recording with a DVD-RW disc in Video mode, initialize in Video mode before you start recording. (When you initialize, all of the recorded content of the disc is erased. Before initializing, check the content of the disc so that you do not erase any content you need.) You cannot erase with DVD-R disc. | YES NO |
| | AUTO INITIALIZE <ul style="list-style-type: none"> This sets the Recorder so it automatically initializes any unused DVD-RW discs which are loaded into the Recorder. You can initialize in either VR mode or Video mode. | VR VIDEO |

FINALIZE

| | | |
|---------------------|--|-----------|
| DVD FINALIZE | DVD FINALIZE <ul style="list-style-type: none"> Set this when you want to play back a VR mode or Video mode disc using another recorder capable of playback. If you finalize a recording on DVD-R disc, you will not be able to record any more on the disc. Finalization can take anywhere from a few minutes to one hour. During finalization, all types of operation are disabled (including turning off power and removing the disc). Do not unplug the power cord during finalization. Doing so may make the disc unusable. | YES NO |
| | UNDO DVD FINALIZE <ul style="list-style-type: none"> This resets a finalized DVD-RW disc so you can record on it again. | YES NO |

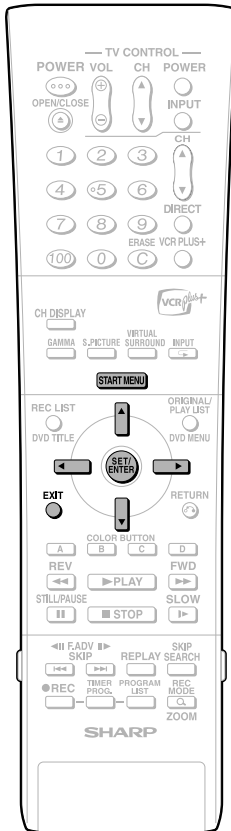

Basic Operation for INITIALIZE/FINALIZE

Example: Setting "VR MODE INIT." (VR mode)

- 1** Press **START MENU** to display **START MENU** screen.
- 2** Press **▲/▼/◀/▶** to select "**INITIALIZE/FINALIZE**", then press **SET/ENTER**.

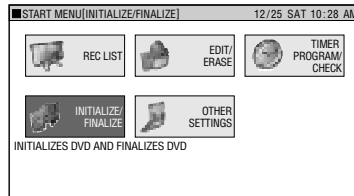

- 2** Press **▲/▼** to select "**INITIALIZE**" or "**FINALIZE**".

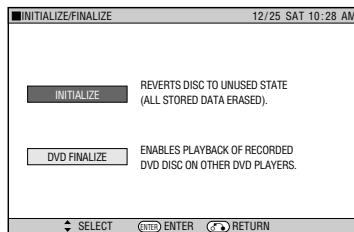

- 3** Press **▲/▼** to select "**VR MODE INIT.**", then press **SET/ENTER**.

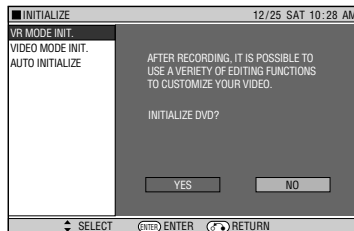

- 4** Press **◀/▶** to select "**YES**", then press **SET/ENTER**.
 - Initializing (or finalizing) will be executed.

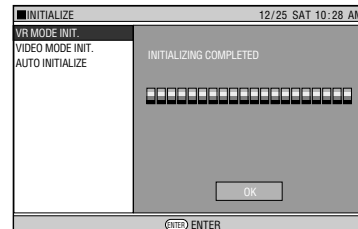
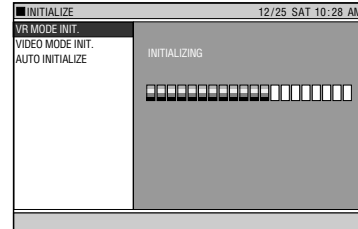

- Initializing (or finalizing) will be completed.

- 2** Press **SET/ENTER**.
 - Screen in step **2** appears.

- 5** Press **EXIT** to exit from **INITIALIZE/FINALIZE** screen.

NOTE

- Finalization processing will take anywhere from a few minutes to about an hour. (Processing will take time if there is a lot of empty space or if there are many titles on the DVD disc.)

Troubleshooting

The following problems do not always suggest a defect or malfunction of this Recorder. Perform the checks listed below before calling service.

| Problem | Suggested Solution |
|--|--|
| The Recorder power does not turn on. | <ul style="list-style-type: none">• Is the power cord firmly plugged into the AC outlet?• If the power cord is plugged into the outlet, unplug it once, wait about one minute, and then plug it in again. Then turn power on. |
| The Recorder sounds like it is operating, even when power is turned off. | <ul style="list-style-type: none">• This is the sound the Recorder makes during operation like timer recording. |
| The disc is automatically ejected after closing the disc tray. | <ul style="list-style-type: none">• Make sure that the disc is loaded properly (aligned in disc tray and label-side up).• Take out the disc and clean it.• Make sure that region number on the disc match the region number in this Recorder.• Make sure that the disc is playable. |
| No picture. | <ul style="list-style-type: none">• Make sure that the cables are connected correctly.• Make sure that the connected TV or the AV amplifier is set to the correct input.• Take out the disc and clean it.• Make sure that region number on the disc match the region number in this Recorder.• If you set to "PROGRESSIVE SCAN ON", non-broadcast video signals will not be output from terminals other than COMPONENT Output jacks. (Page 80) When pressing ► PLAY, "480P" is displayed on the Front panel display. |
| The Recorder does not play a disc. | <ul style="list-style-type: none">• Take out the disc and clean it.• Make sure that the disc is loaded properly (aligned in disc tray and label-side up).• Make sure that region number on the disc match the region number in this Recorder.• Remove the dew in the Recorder.• Check that the disc is recorded in NTSC format.• The Recorder cannot play back video which was not recorded normally.• Proper playback may be impossible due to the state of the disc recording, a scratched, warped or dirty disc, the state of the pick-up, or compatibility issues between this Recorder and the disc being used. |
| Settings have disappeared. | <ul style="list-style-type: none">• If, while its power is on, the Recorder is unplugged (or there is a power failure) for more than about 1 hour, the settings will be lost. Make sure that you turn off the Recorder before unplugging the power cord. |
| Screen freezes and operation buttons do not work. | <ul style="list-style-type: none">• Press ■ STOP and restart playback.• Turn off the power and turn on the power again.• If power does not go off, press the RESET button inside the front door of the Recorder. (Page 88) |
| The remote control does not work. | <ul style="list-style-type: none">• Is the Tamper Proof function active? (Page 34)• Set the remote control and the Recorder to the same remote control code. (Page 20)• Use the remote control within its operating range.• Replace the batteries. |
| No sound or sound is distorted. | <ul style="list-style-type: none">• If the volume of TV or amplifier is set to minimum, turn the volume up.• There is no sound during still mode, slow motion playback, fast forward and fast reverse.• DVD audio recorded in DTS is only output from the DIGITAL AUDIO Output terminals. Connect a DTS-compatible digital amplifier or decoder to the DIGITAL AUDIO Output OPTICAL or COAXIAL terminal on this Recorder.• Check that the audio cable is connected correctly.• Check that the cable plugs are clean.• Take out the disc and clean it.• Audio may not be output depending on the audio recording status, such as when audio other than an audio signal or non-standard audio is recorded for the audio content of the disc. |
| The picture from external input is distorted. | <ul style="list-style-type: none">• If the signal is copy-protected, you cannot connect via this Recorder. Connect the external equipment directly to your TV. |
| The screen is stretched vertically or horizontally. | <ul style="list-style-type: none">• Set the TV mode according to the TV you are connecting. (Page 80)• If the above operation does not set the TV mode, set it using the functions of the connected TV. |

Troubleshooting

| Problem | Suggested Solution |
|--|---|
| A disc recorded using this Recorder cannot be played back on another DVD player. | <ul style="list-style-type: none">• Check that the disc is finalized when the disc is in video mode.• Some players will not play even a finalized disc.• If the disc was recorded in VR mode, it can only be played back with an RW compatible player. (In some cases, the disc must be finalized.) |
| The playback screen will be disturbed if DVD video is recorded to a VCR, or played back through a VCR. | <ul style="list-style-type: none">• This Recorder is compatible with the copy guard of analog copy protect system. Some discs contain a copy prohibiting signal. If you try to play back such a disc through a VCR, or record to a VCR and playback, copy guard will prevent normal playback. |
| TV operates incorrectly. | <ul style="list-style-type: none">• Some TVs with wireless remote control capability may operate incorrectly when using the remote control of this Recorder. Use such TV away from this Recorder. |
| Recording stops. | <ul style="list-style-type: none">• Recording may stop temporarily at parts where recording is impossible (due to scratches or disc fouling, etc.). When recording starts again, the starting part will be recorded as another title. If the disc is in a condition where recording is impossible, it is ejected.• When the recording is interrupted, you might lose a few minutes of the recorded content immediately before the interrupted point. |
| You recorded, but nothing was recorded on disc. | <ul style="list-style-type: none">• If you record a channel with no broadcast (i.e. where the broadcast has ended), recording will be done with no video. Likewise, if you record a channel with poor reception, recording may be done with no video.• Clean the disc. |
| Cannot record, or recording stops while in progress. | <ul style="list-style-type: none">• Check whether there is enough empty space on the disc being recorded to.• Check whether the disc is protected.• Check whether the number of original titles is 99 (for a DVD-RW/R).• Check whether you are trying to record video whose recording is prohibited.• Check whether there was a power failure while waiting for (or during) timer recording.• Clean the disc.• Proper playback may be impossible due to a scratched, warped or dirty disc, the state of the pick-up, or compatibility issues between this Recorder and the disc being used. |
| Video is disturbed (looks abnormal) during external input or when receiving a broadcast with poor reception. | <ul style="list-style-type: none">• Use with "3D Y/C SEPARATION" set to "NO". (Page 81) |
| There is no video and no audio. | <ul style="list-style-type: none">• Is the power cord unplugged from the AC outlet?• Is power in the "OFF" state?• Does the broadcast have no video or audio?• Has the Recorder been switched to external input? |
| There is just audio with no video. | <ul style="list-style-type: none">• Is the connection cable for video output connected properly? |
| Horizontally wide video appears vertically tall, or black bands appear at the top and bottom of the screen. | <ul style="list-style-type: none">• Is "TV MODE" set to match the connected TV. (Page 80)• If you are using a wide TV, is the TV mode set to "WIDE 16:9"? (Page 80) |
| Square noise (mosaic) appears on the screen. | <ul style="list-style-type: none">• Pictures in blocks may be conspicuous in scenes with rapid movement due to the characteristics of digital image compression technology. |
| Video stops. | <ul style="list-style-type: none">• Has the Recorder been subjected to shock or impact? Are you using it at an unstable location? The Recorder will stop if it senses shock or vibration. |
| Left and right channels of audio are reversed, or sound comes out of only one side. | <ul style="list-style-type: none">• Are left and right audio cables connected to the opposite terminal, or is one side disconnected? |
| If the message SET PROGRESSIVE SCAN TO "OFF" appears during Other Settings. | <ul style="list-style-type: none">• Correctly set "CONNECTING TERMINAL" at "VIDEO/AUDIO SETTING" in "ADJUSTMENT". (Page 80) |
| DVD Video discs does not play back automatically. | <ul style="list-style-type: none">• Have you set a DVD Video disc that has an automatic playback function? |

Continued on Next Page ►►►

Troubleshooting

| Problem | Suggested Solution |
|---|---|
| Timer recording was set, but not executed. | <ul style="list-style-type: none">• Was there a power failure while standing by for timer recording?• Is the DVD full? Erase unnecessary titles from the list.• Is the power cord unplugged from the AC outlet? |
| The timer recorded content stops in the middle of recording. | <ul style="list-style-type: none">• Was the power plug unplugged, or was there a power failure, during timer recording?• Is the DVD full? Erase unnecessary titles from the list.• Recording will stop if a program whose recording is forbidden begins in the middle of recording.• Clean the disc.• If there is a power failure or other power problem during recording to DVD-RW/R, recording will stop in the middle. |
| When a CD is recorded to MD using digital connection, the CD and MD do not have the same track numbers. | <ul style="list-style-type: none">• If the interval between CD tracks is short, the track numbers on the recorded MD may differ from the CD. |
| The Recorder heats up during use. | <ul style="list-style-type: none">• When using this Recorder, the console cabinet may heat up, depending on the use environment. This is not a malfunction. |
| A blinking "----" appears on the front display panel. | <ul style="list-style-type: none">• The clock has not been set. Set the clock. |

NOTE

- If this Recorder receives strong interference from strong external noise such as excessive static electricity, malfunction of power supply voltage caused by lightning during Recorder use or a wrong operation is sent to the Recorder, errors like the Recorder not accepting an operation may occur.
- Press **RESET** with a toothpick or other narrow rod-like object (nonmetal) when the Recorder does not operate properly even after the power has been turned off and then back on again.
- Since the clock, channel, timer recording programs and other data in memory are also reset when **RESET** has been pressed, they must be set again.
- EZ Set Up function starts automatically when **RESET** is pressed.
- When the problem persists even after pressing **RESET**, pull out the plug and put it back again. If this does not solve the problem, contact the nearest Sharp Authorized Service Center.

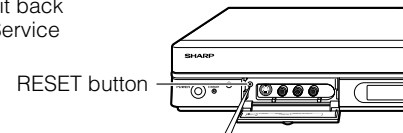

Service Information (For the U.S.)

For the location of the nearest Sharp Authorized Service Center, or to obtain product literature, accessories, supplies or customer assistance, please call **1-800-BE-SHARP** (1-800-237-4277) or visit SHARP's website (<http://www.sharpusa.com>).

1. Do not attempt to service this product yourself. Instead, unplug it and contact a qualified service technician. (See **CONSUMER LIMITED WARRANTY** at the end of this manual.)
2. Be sure the service technician uses authorized replacement parts or their equivalents. Unauthorized parts may cause fire, electrical shock, or other hazards.
3. Following any service or repair, be sure the service technician performs safety checks to certify that this product is in safe operating order.

On-screen Error Messages

Messages Relating to DVD Discs

- The following messages appear on the TV screen in case the disc you tried to play back is not appropriate or the operation is not correct.

| Error message | Possible Error | Suggested Solution |
|--|--|--|
| CANNOT PLAY BACK THIS DISC. | <ul style="list-style-type: none"> The disc cannot be played with this Recorder. | <ul style="list-style-type: none"> Check the disc, and load it correctly. |
| THIS IS A NON-STANDARD DISC. | <ul style="list-style-type: none"> If you load a disc which cannot be played with this Recorder (i.e. a scratched disc), or if you load a disc upside down, this message will appear, and the disc tray will automatically pop out. | |
| REGION CODE OF DISC IS WRONG. | <ul style="list-style-type: none"> Occurs if you load a DVD disc whose region number is not "ALL" or whose region number does not contain "1". | |
| DISC NOT INSERTED. | <ul style="list-style-type: none"> Occurs if no disc is loaded in the disc tray. | |
| CANNOT OPERATE THIS FUNCTION. | <ul style="list-style-type: none"> Occurs if operation is incorrect. | _____ |
| DISC IS PROTECTED. | <ul style="list-style-type: none"> Occurs if you attempt to record or edit a disc for which disc protection is set. | <ul style="list-style-type: none"> Cancel disc protection, or reload a recordable disc. |
| COULD NOT REPAIR THE DISC. | <ul style="list-style-type: none"> If there is a power failure during DVD recording, the system automatically tries to recover data after power is restored. This error occurs if such recovery is impossible. | _____ |
| COULD NOT FINALIZE. | <ul style="list-style-type: none"> Occurs if the disc is scratched or dirty, etc. | <ul style="list-style-type: none"> Check the disc, and load it correctly. |
| THIS VIDEO IS COPY PROTECTED. RECORDING IS NOT POSSIBLE. | <ul style="list-style-type: none"> Occurs if video with a copy guard signal is input. | <ul style="list-style-type: none"> Cannot record. |
| CANNOT RECORD MORE. | <ul style="list-style-type: none"> Occurs if a title or chapter mark exceeds the recordable upper limit. Number of titles: 99. Number of chapters: 999 | <ul style="list-style-type: none"> Erase unnecessary titles. Either erase unnecessary chapters, or combine chapters. |
| CANNOT RECORD ON THIS DISC. | <ul style="list-style-type: none"> Occurs if you load a disc which cannot be recorded to with this Recorder, or a disc which is scratched or dirty. | <ul style="list-style-type: none"> Reload an appropriate recording disc. |
| COULD NOT INITIALIZE. | <ul style="list-style-type: none"> Occurs if the disc is scratched or dirty, etc. | <ul style="list-style-type: none"> Check the disc, and load it correctly. |
| DISC IS FULL. CANNOT RECORD OR STORE. | <ul style="list-style-type: none"> Occurs if there is no empty space in the disc. | <ul style="list-style-type: none"> Load a disc with empty space. Erase unnecessary titles. |
| CANNOT RECORD VIDEO TO THIS DISC. | <ul style="list-style-type: none"> Occurs if you try to record a "Copy Once" broadcast onto a disc which is not compatible with CPRM. | <ul style="list-style-type: none"> Load a CPRM compatible disc (DVD-RW Ver. 1.1 or higher) initialized in VR mode. |
| SET THE DATE AND TIME. | <ul style="list-style-type: none"> Occurs if timer programming is done when the Recorder clock has not been set. | <ul style="list-style-type: none"> Set the clock and perform timer programming again. |

Continued on Next Page ►►►

On-screen Error Messages

| Error message | Possible Error | Suggested Solution |
|--|---|---|
| RECORDING WAS STOPPED DUE TO FULL DISC. | <ul style="list-style-type: none"> Occurs when empty space in the disc runs out. | _____ |
| REPAIRING THE DISC. | <ul style="list-style-type: none"> Occurs when recording stops before disc information has been correctly written onto a DVD, due to a problem like a power failure. | <ul style="list-style-type: none"> Wait until DVD disc recovery is finished. |
| THIS IS A NON-STANDARD DISC. REMOVE IT. | <ul style="list-style-type: none"> Occurs if the loaded disc cannot be recorded to or played because it is a non-standard or scratched, etc. | <ul style="list-style-type: none"> Remove the disc. |
| THIS VIDEO CANNOT BE RECORDED TO THIS DISC. TIMER RECORDING COULD NOT START. | <ul style="list-style-type: none"> Occurs if you try to record "Copy Once" video onto DVD-R or non-CPRM compatible DVD-RW. | <ul style="list-style-type: none"> Record on CPRM compatible DVD-RW disc in VR mode. |
| LIVE BROADCAST RECORDING PROHIBITED. RECORDING STOPPED. | <ul style="list-style-type: none"> Occurs if a program begins during recording, and recording of the broadcast itself is forbidden due to copyright protection. | _____ |
| THIS VIDEO IS COPY PROTECTED. RECORDING IS NOT POSSIBLE. | <ul style="list-style-type: none"> Occurs if you attempt to record a program, and recording of the broadcast itself is forbidden due to copyright protection. | _____ |

Messages during Editing

| Error message | Possible Error | Suggested Solution |
|--|--|--|
| CANNOT SELECT MORE. | <ul style="list-style-type: none"> Occurs if you attempt to select more than 20 titles (chapters) when you perform Erase Selected Title. | <ul style="list-style-type: none"> Erase a maximum of 20 titles (chapters) at a time. |
| CANNOT SET THIS POSITION. | <ul style="list-style-type: none"> Occurs if you attempt to designate a range shorter than 3 seconds and edit. | <ul style="list-style-type: none"> Designate a range of 3 seconds or more. (If you designate a range of 3 seconds or more, you can designate in frame units.) |
| CHAPTER IS FULL. CANNOT OPERATE THIS FUNCTION. | <ul style="list-style-type: none"> Occurs if the editing result exceeds the upper limit of total number of chapters (999). | <ul style="list-style-type: none"> Edit after erasing unnecessary chapter marks by combining chapters. |
| CANNOT COMBINE THESE CHAPTERS. | <ul style="list-style-type: none"> Occurs if you attempt to combine chapters which cannot be combined. (Chapters created when you erase a scene or chapter in a single title cannot be erased). | _____ |

Other Message

| Front panel display message | Possible Error | Suggested Solution |
|---|--|--------------------|
|  | <ul style="list-style-type: none"> Occurs if pressing the play button when the Recorder is connected with the Video In or S-Video In jack of a TV, and PROGRESSIVE OUT is set to "PROGRESSIVE SCAN ON". | _____ |

Glossary

| | |
|--|---|
| Angle | Recorded onto some DVD discs are scenes which have been simultaneously shot from a number of different angles (the same scene is shot from the front, from the left side, from the right side, etc.). With such discs, you can select the angle on Function Control Screen to view the scene from different angles. |
| AV AUTO REC | This function lets you record video from an external equipment in linkage with the timer programming of that device. This can be done by connecting with a receiver or other equipment with a timer programming function. |
| Chapter Number | These numbers are recorded on DVD discs. A title is subdivided into many sections, each of which is numbered, and specific parts of video presentations can be searched quickly using these numbers. |
| Copy Guard | This function prevents copying. You cannot record software or broadcast programs marked by the copyright holder with a signal which limits copying. |
| Digital Gamma | Corrects for gradations in dark areas of images to make images clearer. |
| Digital Super Picture | Enhances the fine detail of the image and outlines of the objects it contains. |
| Disc Menu | This lets you select things like the subtitle language or overdub audio using a menu stored on the DVD video disc. |
| Dolby Digital (5.1 channel) | A sound system developed by Dolby Laboratories Inc. that gives movie theater ambience to audio output when the product is connected to a Dolby Digital 5.1 channel processor or amplifier. |
| Dolby Digital Output Level | Setting that increases the average volume of Dolby Digital audio when playing a DVD. |
| Dolby Virtual Surround | This lets you enjoy Surround audio via analog connection with a stereo (2ch) TV or audio equipment. |
| DTS | This is a digital sound system developed by Digital Theater Systems for use in cinemas. This system uses 6 audio channels and provides accurate sound field positioning and realistic acoustics. (By connecting a DTS Digital Surround decoder, you can also listen to DTS Digital Surround sound.) |
| Exact Recording | This function automatically changes the recording mode to prevent recordings from running out before they are finished due to a lack of available DVD disc space by comparing the available disc space and the time required for the timer recording. |
| EZ Set Up | Tuner channels and clock are automatically set for both Air and CATV channels. |
| Finalization | This is done to enable playback of discs (Video mode) recorded with this Recorder using other DVD-RW and DVD-R compatible DVD players. (We do not guarantee that playback will be possible with all DVD players.) The DVD players which can play back VR mode discs are those with an "RW" indication. |
| Initialization | This allows you to use a DVD-RW disc in this Recorder. If you initialize a disc, all of the programs recorded on it are erased. |
| Letter Box  | Screen size that cuts off the top and bottom of the image to allow playing of wide-screen (16:9) software on a connected 4:3 TV. |

Continued on Next Page ►►►

Glossary

| | |
|--|--|
| Linear PCM Sound | Linear PCM is a signal recording format used for Audio CDs. The sound on Audio CDs is recorded at 44.1 kHz with 16 bits. (On DVD discs, sound is recorded at between 48 kHz with 16 bits and 96 kHz with 24 bits.) |
| MP3 | One type of audio compression that uses MPEG1. This format compresses sound to about 1/10, without impairing the original sound quality. |
| Multi Angle | This is a feature of DVD video discs. In some discs, the same picture is shot from different angles, and these are stored in a single disc so you can enjoy playback from different angles. (This function can be enjoyed if the disc is recorded with multiple angles.) |
| Multi Audio | This is a feature of DVD video discs. This function makes it possible to record multiple different audio tracks for the same video, so you can enhance your enjoyment by switching audio. (You can enjoy this function with discs recorded with multiple audio tracks.) |
| Original | A video (title) recorded from a TV broadcast or external input is called an "Original". |
| Pan Scan <small>4:3 PS</small> | Screen size that cuts off the sides of the image to allow playing of wide-screen (16:9) software on a connected 4:3 TV. |
| Parental Control | In some digital broadcasts and DVD video discs, a control level for disc viewing is set depending on the age of the viewer. With this Recorder, you can set the control level for viewing such broadcasts and discs. |
| Play List | A set of titles created by copying just the needed scenes from original titles is called a "Play List". (The original titles remain as are.) |
| Playback Control (PBC) | This information is recorded on video CDs (version 2.0). This allows you to actively select the sections to be viewed or listened to, using a menu displayed on the TV. |
| REC LIST | This is a list screen which lets you check the recorded programs (titles) in list form. You can select either Thumbnail or Title List as the REC LIST. |
| Region Number | Number identifying a geographic region of compatibility for a DVD. |
| Remote Control Code | This is the type of the remote control signal for operating the recorder. There are two types of remote control signal: "Remote Control No. 1" (RC-1) and "Remote Control No. 2" (RC-2). |
| Resume Playback | If you stop playback while it is in progress, the Recorder stores the stop position in memory, and this function lets you play back from that stopping point. |
| Skip | This returns to the start of the chapter (or track) being played, or skips to the next chapter (or track). |
| Subtitles | These are the printed lines appearing at the bottom of the screen which translate or transcribe the dialog. They are recorded on DVD discs. |
| Time Number | This indicates the play time which has elapsed from the start of a disc or a title. It can be used to find a specific scene quickly. (It may not work with some discs.) |
| Title Menu | In a DVD video disc, this is the menu for selecting things like the chapter to be played back and the subtitle language. In some DVD video discs, the top menu may be called the "Title". |

- Title Number** These numbers are recorded on DVD discs. When a disc contains two or more movies, these movies are numbered as title 1, title 2, etc.
- Track Number** These numbers are assigned to the tracks which are recorded on video CDs and Audio CDs. They enable specific tracks to be located quickly.
- VBR Control** VBR is the abbreviation for Variable Bit Rate control. This feature performs control by varying the bit rate (the amount of code transferred in a fixed period of time) by assigning a larger amount of code to complex video images such as sections containing rapid movement or sections containing sudden changes in color, and assigning a smaller amount of code in the opposite cases.
- Video Mode** This is a recording format for making DVD -RW/R discs playable with other commercially available DVD players. (We do not guarantee that playback will be possible with all DVD players.)
- VR Mode** This recording format is the basic DVD-RW recording format, and lets you enjoy the various editing functions available with this Recorder.

Specifications

General

| | |
|---------------------------------|---|
| Power supply: | AC 120 V, 60 Hz |
| Power consumption (Normal): | 23 W |
| Power consumption (Standby): | 0.7 W (While the Front Panel Display is off) |
| Dimensions: | Approx. 430 mm × 69 mm × 257 mm (W × H × D) Approx. 16 ¹⁵ / ₁₆ " × 2 ²³ / ₃₂ " × 10 ¹ / ₈ " |
| Weight: | Approx. 3.6 kg (8.0 lbs) |
| Operating temperature | 41°F to 95°F (5°C to 35°C) |
| Storage temperature: | -4°F to 131°F (-20°C to 55°C) |
| Operating humidity: | 10% to 80% (no condensation) |
| TV systems: | NTSC system, 525 lines, 60 fields |

Recording

| | |
|--|---|
| Recordable disc media: | DVD-RW, DVD-R |
| Recording system (DVD-RW/R): | Video: DVD-Video Recording (VR mode) DVD-VIDEO (Video mode) Audio: Dolby Digital (2ch)/Linear PCM (FINE mode only) |
| Recording time (With 4.7GB DVD-RW/R): | FINE (High picture quality): Approx. 1 hour SP (Standard): Approx. 2 hours LP (2X): Approx. 4 hours EP (3X): Approx. 6 hours MN (Manual): 32 levels between FINE and EP |

Playback

| | |
|-----------------|--|
| Playable discs: | DVD Video, DVD-RW/R, Audio CD (CD-DA), Video CD, CD-RW/ R (CD-DA, Video CD format, MP3 file format) |
|-----------------|--|

Tuner

| | |
|-------------------|-------------------------------------|
| Channel coverage: | VHF 2-13 UHF 14-69 CATV 1-125 |
|-------------------|-------------------------------------|

Timer

| | |
|----------------|--|
| Programs: | 8 programs/1 year |
| Clock: | Quartz lock (12-hour digital display) |
| Memory backup: | Approx. 1 hour |

Input/Output

| | |
|--|---|
| VHF/UHF antenna input/ output terminal: | 75Ω (F-shape connector) |
| Video input: | Input 1, 2 (rear), 3 (front) |
| Input level: | 1 Vp-p (75Ω) |
| Jacks: | RCA jack |
| Video output: | |
| Output level: | 1 Vp-p (75Ω) |
| Jacks: | RCA jack |
| S-Video input: | Input 1, 2 (rear), 3 (front) |
| Y-Input level: | 1 Vp-p (75Ω) |
| C-Input level: | 0.286 Vp-p (75Ω) |
| Jacks: | 4 pin mini DIN |
| S-Video output: | |
| Y-Output level: | 1 Vp-p (75Ω) |
| C-Output level: | 0.286 Vp-p (75Ω) |
| Jacks: | 4 pin mini DIN |
| Component video output: | |
| Output level: | Y: 1 Vp-p (75Ω) Pb, Pr: 0.7 Vp-p (75Ω) |
| Jacks: | RCA jack |
| Audio input: | Input 1, 2 (rear), 3 (front) L/R |
| Input level: | 2 V rms (Input impedance: more than 22 kΩ) |
| Jacks: | RCA jack |
| Audio output: | L/R |
| Input level: | 2 V rms (Output impedance: less than 1.5 kΩ) |
| Jack: | RCA jack |
| Digital audio optical output: | |
| Terminal: | Square Optical terminal |
| Digital audio coaxial output: | |
| Jack: | RCA jack |

LASER Specification

| | |
|--------------|---------------------------|
| Wave length: | DVD: 658 nm CD: 784 nm |
| Laser power: | DVD: 100 mW CD: 225 mW |

Specifications are subject to change without notice.

ESPAÑOL

(Guía de operación rápida)

| | |
|--|-----------|
| MEDIDAS DE SEGURIDAD IMPORTANTES | 97 |
| Guía de operación rápida en español | 98 |
| Conexión básica | 98 |
| EZ Set Up | 98 |
| Antes de utilizar la grabadora | 99 |
| Grabación directa en DVD | 99 |
| Reproducción DVD-RW/R | 100 |
| Reproducción de DVD Vídeo | 100 |
| Reproducción de Audio CD/Vídeo CD | 100 |

Para futura referencia, anote los números de modelo y de serie (indicados en la parte posterior este producto) en el espacio provisto.

Nº. de modelo: DV-SR3U
Nº. de serie: _____

AVISO: PARA REDUCIR EL RIESGO DE INCENDIO O ELECTROCHOQUE NO EXPONGA ESTE APARATO A LA HUMEDAD.

| | | | | |
|---|--|---|---|--|
|  | PRECAUCION PELIGRO DE DESCARGA ELECTRICA NO ABRIR |  |  | Este símbolo previene al usuario del voltaje aislado dentro de la unidad que puede provocar descargas eléctricas peligrosas. |
| <p>PRECAUCION: TPARA REDUCIR EL RIESGO DE DESCARGA ELECTRICA, NO quite la cubierta. EL USUARIO NO DEBERA DAR NINGUN TIPO DE SERVICIO A NINGUNA PARTE INTERNA. DEBERA SER REALIZADO SOLO POR PERSONAL DE SERVICIO CALIFICADO.</p> | | |  | Este símbolo advierte al usuario que existen instrucciones de operación y de mantenimiento en la literatura incluida en esta unidad. |

“ADVERTENCIA—Las reglas de la FCC (Comisión Federal de Comunicaciones) estipulan que cualquier modificación o cambio a este equipo no aprobado expresamente por el fabricante podrá anular la autorización del usuario para operar este equipo”.

INFORMACION

Este equipo se ha sometido a todo tipo de pruebas y cumple con las normas establecidas para dispositivo digital de Clase B, de conformidad con la Parte 15 de las reglas de la FCC (Comisión Federal de Comunicaciones). Estas reglas están diseñadas para asegurar una protección razonable contra interferencias perjudiciales en las instalaciones residenciales. Este equipo genera, utiliza y puede emitir energía de radiofrecuencia y, si no se instala y utiliza debidamente, es decir, conforme a las instrucciones, podrían producirse interferencias perjudiciales en las radiocomunicaciones. Sin embargo, no se garantiza que estas interferencias no se produzcan en una instalación determinada. Si este equipo ocasiona interferencias en la recepción de radio o televisión, lo cual puede comprobarse con sólo apagar y encender el equipo, intente corregir el problema mediante una o una combinación de las siguientes medidas:

- Reoriente la antena receptora o cámbiela de lugar.
- Aumente la separación entre el equipo y el receptor.
- Enchufe el equipo a una toma de corriente situada en un circuito distinto del receptor.
- Consulte a su distribuidor o a un técnico experto en radio/televisión.

PRECAUCION:

ESTA UNIDAD HA SIDO CLASIFICADA COMO PRODUCTO CLASS 1 LASER.

EL USO DE MANDOS O AJUSTES O LA REALIZACION DE PROCEDIMIENTOS DISTINTOS DE LOS INDICADOS EN LA PRESENTE IMPLICA EL RIESGO DE EXPOSICION A UNA RADIACION PELIGROSA.

COMO LOS RAYOS LASER UTILIZADOS EN ESTA UNIDAD PUEDEN RESULTAR PERJUDICIALES PARA SUS OJOS, NO INTENTE DESARMAR EL GABINETE.

SOLICITE EL SERVICIO UNICAMENTE A PERSONAL CUALIFICADO.

Aviso al instalador de sistemas CATV:

Este aviso tiene la finalidad de llamar la atención del instalador de sistemas CATV para que tenga en cuenta el Artículo 820-40 de NEC, que ofrece instrucciones para realizar una conexión a tierra apropiada y, en particular, especifica que el cable de puesta a tierra deberá conectarse al sistema de puesta a tierra del edificio tan cerca del punto de entrada del cable como sea posible.

Los productos que han ganado la marca ENERGY STAR® han sido diseñados para proteger el medio ambiente mediante una eficiencia superior en el uso de la energía.

MEDIDAS DE SEGURIDAD IMPORTANTES

PRECAUCIÓN: Lea todas estas instrucciones antes de utilizar este producto y guárdelas para consultarlas posteriormente.

La energía eléctrica permite realizar muchas funciones útiles. Este producto se ha diseñado y fabricado para garantizar su seguridad personal. EL USO INADECUADO PUEDE RESULTAR EN PELIGROS DE DESCARGAS ELÉCTRICAS O INCENDIOS POTENCIALES. Con el fin de respetar las medidas de seguridad incorporadas en este producto, tenga en cuenta las siguientes reglas básicas de instalación, uso y servicio técnico.

- 1. Lectura de las instrucciones** – Todas las instrucciones de seguridad y uso deben leerse antes de utilizar el producto.
- 2. Conservación de las instrucciones** – Las instrucciones de seguridad y uso deben guardarse para usarlas como referencia en el futuro.
- 3. Advertencias** – Deben observarse todas las advertencias del producto y de las instrucciones de uso.
- 4. Instrucciones** – Deben seguirse todas las instrucciones de uso.
- 5. Limpieza** – Desenchufe este producto de la toma de alimentación antes de limpiarlo. No utilice limpiadores líquidos ni aerosoles. Utilice un paño húmedo.
- 6. Aditamentos** – No utilice aditamentos no recomendados por el fabricante del producto, ya que pueden causar peligros.
- 7. Agua y humedad** – No utilice este producto cerca del agua, por ejemplo, cerca de una bañera, cubeta de lavado, fregadero de cocina, en un sótano húmedo, ni cerca de una piscina, etc.
- 8. Accesorios** – No coloque este producto sobre un carrito, soporte, trípode o mesa inestable. El producto podría caerse, causando heridas graves a niños o adultos y daños graves al propio producto. Utilícelo solamente con un carrito, soporte, trípode o mesa recomendado por el fabricante o vendido con el producto. Cualquier trabajo de montaje del producto deberá realizarse según las instrucciones del fabricante, y deberán utilizarse los accesorios de montaje recomendados por él.
- 9. Transporte** – Mueva el producto con cuidado cuando se encuentre en un carrito. Las paradas bruscas, la fuerza excesiva o las superficies desniveladas pueden causar que el producto y el carrito se caigan.



- 10. Ventilación** – Las ranuras y aberturas de la caja se proporcionan para la ventilación del producto, para asegurar un funcionamiento fiable y para protegerlo contra el sobrecalentamiento, y a la misma vez, estas aberturas no deben bloquearse ni cubrirse. Con el fin de que las aberturas no queden bloqueadas, no coloque el producto sobre una cama, sofá, alfombra u otras superficies similares. Este producto no debe instalarse en un espacio cerrado, como un estante para libros, a menos que reciba una ventilación adecuada o que las instrucciones del fabricante hayan sido observadas.
- 11. Fuentes de alimentación** – Este producto debe utilizarse únicamente con el tipo de fuente de alimentación especificada en la etiqueta de características. Si no está seguro del tipo de suministro eléctrico existente en su hogar, consulte con el proveedor de producto o con la compañía eléctrica local. Con respecto al producto diseñado para utilizarse con pilas, o otras fuentes de suministro consulte el manual de instrucciones.
- 12. Puesta a tierra o polarización** – Este producto dispone de un enchufe polarizado de dos cables (una cuchilla del enchufe es más grande que la otra) o con un enchufe puesto a tierra de tres cables (un tercer conector para puesta a tierra). El enchufe polarizado de dos cables encaja en la toma de alimentación en una única posición solamente. El enchufe a tierra de tres cables se conecta solamente en un tomacorriente con descarga a tierra. Si el enchufe no encaja, solicite a un electricista la sustitución de la toma de alimentación obsoleta. No modifique el enchufe y respete esta medida de seguridad.
- 13. Protección del cable de la alimentación** – Los cables de la alimentación deben instalarse de forma que nadie pueda caminar sobre ellos ni queden atrapados por artículos colocados sobre o contra ellos, poniendo mucha atención a las partes donde los cables entran en contacto con las clavijas, a las tomas de corriente y a los puntos por donde salen del producto.

- 14. Puesta a tierra de la antena exterior** – Si una antena exterior o sistema de cables está conectado al producto, asegúrese de que la antena o sistema de cables esté puesto a tierra de forma que proporcione cierta protección contra sobretensiones y acumulaciones de cargas estáticas. El estatuto 810 del Código Eléctrico Nacional ANSI/NFPA 70 proporciona información relativa a la puesta a tierra adecuada del poste y de la estructura de soporte, puesta a tierra del cable de entrada a una unidad de descarga de antena, tamaño de los conductores de puesta a tierra, ubicación de la unidad de descarga de antena, conexión a los electrodos de puesta a tierra y los requisitos correspondientes al electrodo de puesta a tierra. Refiérase al diagrama siguiente.

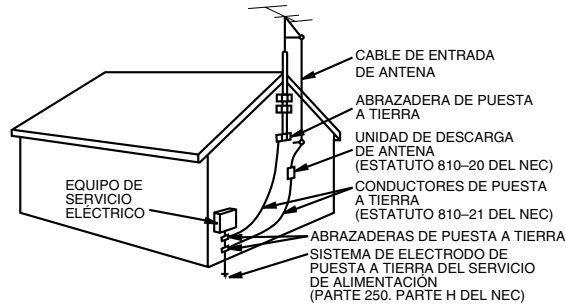

NEC - NATIONAL ELECTRICAL CODE (CÓDIGO ELÉCTRICO NACIONAL)

- 15. Relámpagos** – Como protección complementaria para este producto durante tormentas eléctricas o cuando no lo utilice durante mucho tiempo, desenchúfelo de la toma mural y desconecte la antena o sistema de cables. De esta forma se evitará que el producto se dañe debido a relámpagos y sobretensiones.
- 16. Líneas eléctricas** – Los sistemas de antenas exteriores no deben encontrarse cerca de líneas eléctricas aéreas o de otros circuitos de alimentación o de luz eléctrica, ni donde puedan caer sobre dichos circuitos o líneas. Cuando se instale un sistema de antena exterior, debe tenerse especial cuidado para evitar entrar en contacto con tales circuitos o líneas eléctricas, ya que tal contacto puede ser mortal.
- 17. Sobrecarga** – No sobrecargue las tomas murales, los cables prolongadores ni los receptores integrales, ya que si lo hace pueden producirse incendios o descargas eléctricas.
- 18. Introducción de objetos sólidos y líquidos** – No introduzca nunca ningún tipo de objeto en este producto a través de las ranuras de la caja, ya que pueden entrar en contacto con puntos de tensión peligrosos o cortocircuitar componentes, lo que podría provocar incendios o descargas eléctricas. No derrame nunca ningún tipo de líquido sobre el producto.
- 19. Servicio** – No intente reparar por sí mismo este producto, ya que al abrir o extraer las cubiertas puede quedar expuesto a personal peligrosa y demás peligros. Solicite asistencia técnica a personal especializado.
- 20. Averías que necesitan ser reparadas** – Desenchufe este producto de la toma mural y solicite asistencia técnica a personal especializado en las siguientes condiciones:
 - a. Cuando el cable de alimentación o el enchufe esté dañado.
 - b. Si se ha derramado líquido sobre o caído objetos dentro del producto.
 - c. Si el producto ha estado expuesto a la lluvia o al agua.
 - d. Si el producto no funciona con normalidad al seguir las instrucciones del manual. Ajuste solamente los controles especificados en el manual de instrucciones, ya que el ajuste inadecuado de otros controles puede provocar daños que a menudo requieren un trabajo extenso por parte de un técnico especializado para que el producto recupere su funcionamiento normal.
 - e. Si el producto se ha caído o se ha dañado de alguna manera.
 - f. Cuando el producto exhiba un cambio evidente en su rendimiento (esto indica la necesidad de asistencia técnica).
- 21. Piezas de recambio** – Cuando sean necesarias piezas de sustitución, asegúrese de que el personal de servicio técnico ha utilizado las especificadas por el fabricante o que cuenten con las mismas características que las originales. Las sustituciones no autorizadas pueden provocar incendios, descargas eléctricas u otros peligros.
- 22. Comprobación de seguridad** – Después de haber finalizado cualquier servicio técnico o de reparación de este producto, solicite al técnico que realice comprobaciones de seguridad para determinar que el producto se encuentra en condiciones de funcionamiento.
- 23. Calor** – Este aparato deberá situarse alejado de fuentes de calor como, por ejemplo, radiadores, salidas de calor, estufas y otros aparatos que produzcan calor (incluyendo amplificadores).

Guía de operación rápida en español

Conexión básica

La conexión siguiente es la conexión básica para ver o grabar programas de TV.

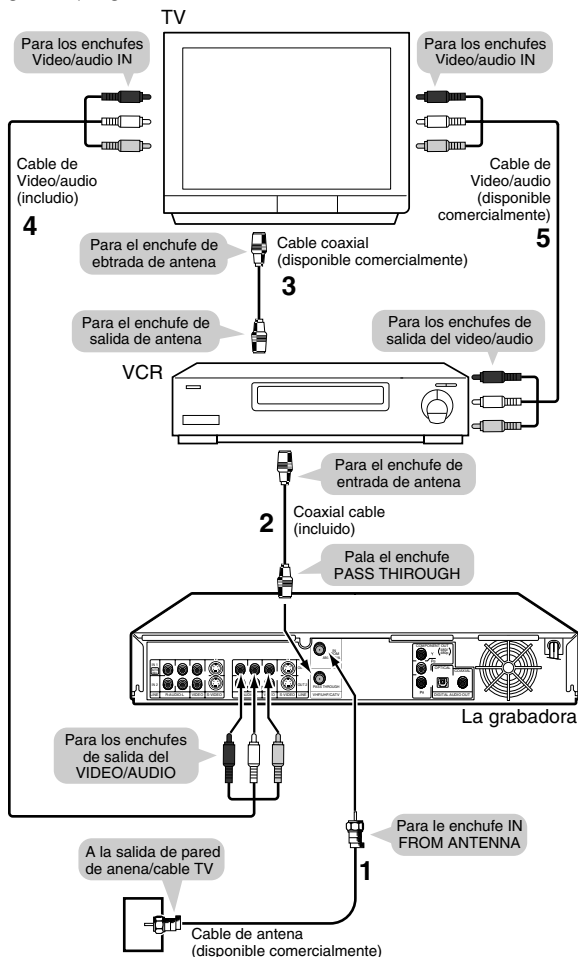

1 Conecte el cable de antena de TV al enchufe IN FROM ANTENNA en la parte trasera de esta grabadora.

2 Conecte el enchufe PASS THROUGH en la parte trasera de esta grabadora, al enchufe de entrada de antena en su VCR usando el cable coaxial suministrado.

NOTA

- Si conecta esta grabadora directamente a su TV, omita el paso siguiente.

3 Conecte el enchufe de salida de antena en su VCR al enchufe de entrada de antena en su TV, usando el cable coaxial.

4 Conecte los enchufes de salida VIDEO/AUDIO en esta grabadora, a los enchufes de entrada VIDEO/AUDIO en su TV usando el cable de video/audio suministrado.

Asegúrese de que los colores de los enchufes y clavijas coincidan cuando conecta el cable.

5 Conecte los enchufes de salida VIDEO/AUDIO en su VCR, a los enchufes de entrada de VIDEO/AUDIO en su TV usando un cable de audio/video.

Después de la conexión

Conecte los cables de alimentación del TV y VCR. Luego vaya "EZ Set Up".

EZ Set Up

! IMPORTANTE (Precaución durante EZ Set Up):

- No pulse el botón POWER de la grabadora ni del control remoto.

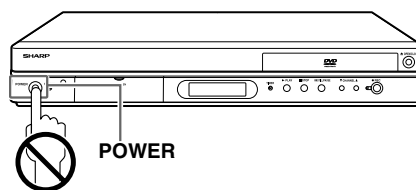

La función de EZ Set Up ajusta automáticamente los canales del sintonizador y el reloj cuando el cable de la antena está conectado al panel trasero de la grabadora y la clavija del cable de alimentación está conectada a una toma de CA.

1 Asegúrese de que el cable de la antena esté conectado. Para conocer la configuración de la conexión, consulte "Conexión básica".

2 Conecte el enchufe de alimentación de la grabadora un tomacorriente y el reloj de CA.

3 Los canales del sintonizador se ajustarán automáticamente.

- Esta grabadora puede controlar y utilizar señales horarias (señales EDS), emitidas por algunos canales de televisión, para poner automáticamente en hora el reloj.

NOTA

- Si la alimentación se suministra a la grabadora antes de que el cable se encuentre conectado, EZ Setup no podrá preajustar los canales en la memoria. Si esto llega a suceder, pulse **RESET** en la parte delantera de la grabadora. La función EZ Set Up volverá a funcionar nuevamente.
- Si se conecta la alimentación durante EZ Set Up, el ajuste automático de los canales se interrumpirá y los canales del sintonizador no podrán ser preajustados.
- La Puesta en Hora Automática del Reloj puede tardar varios minutos.

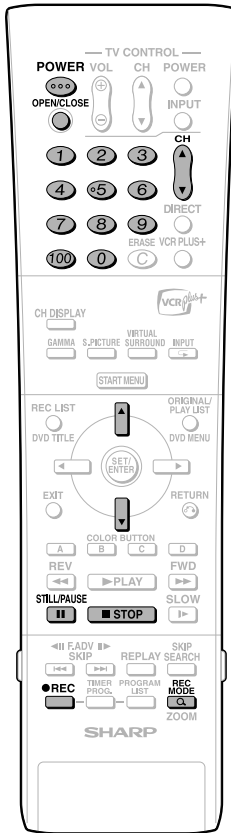

Antes de utilizar la grabadora

1 Coeunte la alimentación del televisor.

- Cuando la grabadora esté conectada a otro equipo de audio, encienda también ese equipo.
- Cambie la entrada de TV a la entrada de AV utilizada para conectar la grabadora.

2 Pulse **POWER** para encender la grabadora.

- Cuando se conecte la alimentación de la grabadora por primera vez después de adquirirla, siguiendo EZ Set Up, se visualizará la pantalla OSD LANGUAGE Select y la función Guía de conexión se activará. Siga las instrucciones de la pantalla.

Grabación directa en DVD

1 Pulse **OPEN/CLOSE** en la grabadora para abrir la bandeja del disco.



2 Ponga un disco DVD-RW o DVD-R en la bandeja del disco.

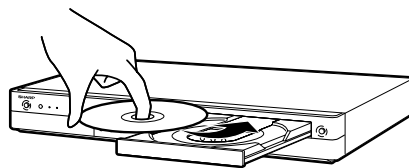

- Introduzca el disco con la cara de la etiqueta hacia arriba.
- En el caso de un disco grabado en ambas caras, ponga la cara que quiera grabar hacia abajo.

3 Pulse **OPEN/CLOSE** para cerrar la bandeja del disco.

4 Pulse los botones **Number** o **CH** ▲/▼ para seleccionar el canal que va a grabar.

5 Pulse **REC MODE** para seleccionar el modo de grabación deseado.

- El modo de grabación cambia como se muestra abajo cada vez que se pulsa el botón.

→ FINE → SP → TP → FP → MN × x →

- El modo de grabación establecido seleccionando "MN x x" es el modo de grabación establecido en la pantalla de selección MANUAL REC MODE.

6 Pulse **REC**.

- Empieza la grabación y se visualiza el icono REC.
- El indicador REC de la parte delantera de la grabadora se enciende en rojo durante la grabación.



7 Pulse **II STILL/PAUSE** para hacer una pausa en la grabación.



- La pausa no funcionará durante la grabación con temporizador.
- Durante la pausa, el indicador REC en la parte delantera de la grabadora parpadea.

8 Pulse **II STILL/PAUSE** para reanudar la grabación.

9 Pulse **■ STOP** para detener la grabación.

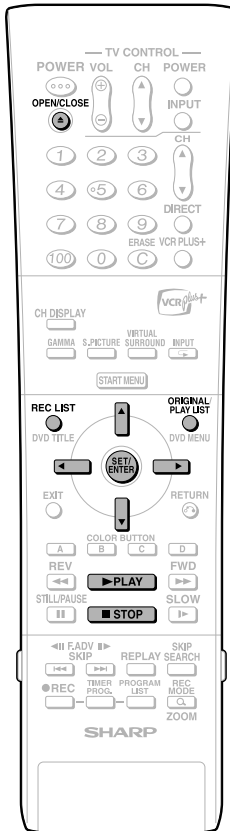

Reproducción DVD-RW/R

DVD RW | DVD RW | DVD R
VR MODE | VIDEO MODE

- 1 Pulse **OPEN/CLOSE** en la grabadora para abrir la bandeja del disco.

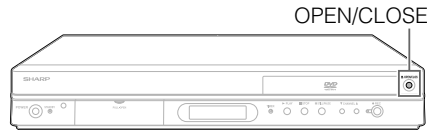

- 2 Ponga el disco que quiera reproducir en la bandeja del disco.



- Introduzca el disco con la cara de la etiqueta hacia arriba.
- En el caso de un disco grabado en ambas caras, ponga la cara que quiera ver hacia abajo.

- 3 Pulse **OPEN/CLOSE** para cerrar la bandeja del disco.

- 4 Pulse **REC LIST** para visualizar la pantalla REC LIST (imágenes miniatura).

- Si el disco introducido tiene una lista de reproducción y usted pulsa **ORIGINAL/PLAY LIST**, la pantalla cambiará a la lista de reproducción.

- 5 Pulse **▲/▼/◀/▶** para seleccionar el título (o capítulo) que quiera ver.

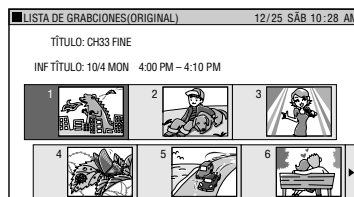

- 6 Pulse **SET/ENTER**.

- 7 Para detener la reproducción, pulse **STOP**.

Función de reanudación de la reproducción.

- Si pulsa **▶ PLAY** a continuación, la reproducción se reanuda desde el punto donde usted la detuvo la última vez. Para reproducir desde el principio, cancele el modo de reanudación pulsando **■ STOP** y luego pulse **▶ PLAY**. (La reanudación de la reproducción se cancelará cuando usted abra o cierre la bandeja del disco, desconecte la alimentación.)
- La función de reanudación de la reproducción no se activa durante la reproducción de CDs de vídeo.

Reproducción de DVD Vídeo

DVD VIDEO

- 1 Introduzca un disco.

- La reproducción puede empezar automáticamente dependiendo del disco.

- 2 Pulse **▶ PLAY**.

- La reproducción empieza desde el primer título.
- El menú tal vez se visualice en primer lugar dependiendo del disco. Haga la operación de reproducción siguiendo las indicaciones de la pantalla.
- Para detener la reproducción, pulse **■ STOP**.

Reproducción de Audio CD/Vídeo CD

VIDEO CD | AUDIO CD

- 1 Introduzca un disco.

- 2 Pulse **▶ PLAY**.

- La reproducción empieza desde la primera pista.

- 3 Para detener la reproducción, pulse **■ STOP**.

CONSUMER LIMITED WARRANTY

(Valid for warranty service in the U.S. only)

CONSUMER LIMITED WARRANTY

SHARP ELECTRONICS CORPORATION warrants to the first consumer purchaser that this Sharp brand product (the "Product"), when shipped in its original container, will be free from defective workmanship and materials, and agrees that it will, at its option, either repair the defect or replace the defective Product or part thereof with a new or remanufactured equivalent at no charge to the purchaser for parts or labor for the period(s) set forth below.

This warranty does not apply to any appearance items of the Product nor to the additional excluded item(s) set forth below nor to any Product the exterior of which has been damaged or defaced, which has been subjected to improper voltage or other misuse, abnormal service or handling, or which has been altered or modified in design or construction.

In order to enforce the rights under this limited warranty, the purchaser should follow the steps set forth below and provide proof of purchase to the servicer.

The limited warranty described herein is in addition to whatever implied warranties may be granted to purchasers by law. ALL IMPLIED WARRANTIES INCLUDING THE WARRANTIES OF MERCHANTABILITY AND FITNESS FOR USE ARE LIMITED TO THE PERIOD(S) FROM THE DATE OF PURCHASE SET FORTH BELOW. Some states do not allow limitations on how long an implied warranty lasts, so the above limitation may not apply to you.

Neither the sales personnel of the seller nor any other person is authorized to make any warranties other than those described herein, or to extend the duration of any warranties beyond the time period described herein on behalf of Sharp.

The warranties described herein shall be the sole and exclusive warranties granted by Sharp and shall be the sole and exclusive remedy available to the purchaser. Correction of defects, in the manner and for the period of time described herein, shall constitute complete fulfillment of all liabilities and responsibilities of Sharp to the purchaser with respect to the Product, and shall constitute full satisfaction of all claims, whether based on contract, negligence, strict liability or otherwise. In no event shall Sharp be liable, or in any way responsible, for any damages or defects in the Product which were caused by repairs or attempted repairs performed by anyone other than an authorized servicer. Nor shall Sharp be liable or in any way responsible for any incidental or consequential economic or property damage. Some states do not allow the exclusion of incidental or consequential damages, so the above exclusion may not apply to you.

THIS WARRANTY GIVES YOU SPECIFIC LEGAL RIGHTS. YOU MAY ALSO HAVE OTHER RIGHTS WHICH VARY FROM STATE TO STATE.

Model Specific Section

| | |
|---|---|
| Your Product Model Number & Description: | DV-SR3U DVD RECORDER (Be sure to have this information available when you need service for your Product.) |
| Warranty Period for this Product: | One (1) year parts and ninety (90) days labor from date of purchase. |
| Additional Item(s) Excluded from Warranty Coverage (if any): | Non-rechargeable batteries. |
| Where to Obtain Service: | From a Sharp Authorized Servicer located in the United States. To find the location of the nearest Sharp Authorized Servicer, call Sharp toll free at 1-800-BE-SHARP. |
| What to do to Obtain Service: | Ship prepaid or carry in your Product to a Sharp Authorized Servicer. Be sure to have Proof of Purchase available. If you ship the Product, be sure it is insured and packaged securely. |

TO OBTAIN SUPPLY, ACCESSORY OR PRODUCT INFORMATION, GO TO OUR WEBSITE AT www.sharppusa.com OR CALL **1-800-BE-SHARP**.

SHARP®

SHARP ELECTRONICS CORPORATION

Sharp Plaza, Mahwah, New Jersey 07430-2135

SHARP CORPORATION

Osaka, Japan

Printed in Malaysia
Impreso en Malasia
TINS-B036WJZZ
04P01-MSK

Free Manuals Download Website

<http://myh66.com>

<http://usermanuals.us>

<http://www.somanuals.com>

<http://www.4manuals.cc>

<http://www.manual-lib.com>

<http://www.404manual.com>

<http://www.luxmanual.com>

<http://aubethermostatmanual.com>

Golf course search by state

<http://golfingnear.com>

Email search by domain

<http://emailbydomain.com>

Auto manuals search

<http://auto.somanuals.com>

TV manuals search

<http://tv.somanuals.com>