

# MODEL **FO-D60**

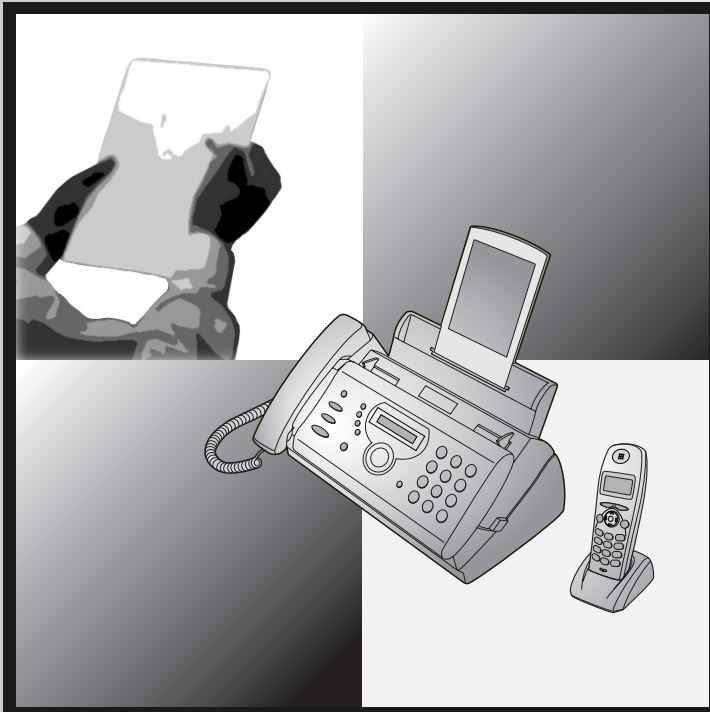

## **FACSIMILE** OPERATION MANUAL

1. Installation
2. Using the Cordless Handset
3. Using the Answering System
4. Sending Faxes
5. Receiving Faxes
6. Making Copies
7. Special Functions
8. Printing Lists
9. Maintenance
10. Troubleshooting

**SHARP**®

# SHARP

## WARRANTY

*Facsimile Products*

### Congratulations on Your Purchase!

This Sharp product is warranted against manufacturing defects for a period of twelve (12) months from the date of original purchase.

In the event of any defect arising in the equipment during the warranty period, such repairs should only be carried out by the Dealer from which the unit was originally purchased or a Service Centre approved by Sharp to service this type of equipment. These repairs would be carried out at no charge to the owner, subject to the conditions specified herein.

The owner is responsible for any transportation and insurance costs if the product has to be returned for repair.

This warranty does not extend to accessories or defects or injuries caused by or resulting from causes not attributable to faulty parts or the manufacture of the product, including but not limited to, defect or injury caused by or resulting from misuse, abuse, neglect, accidental damage, improper voltage, liquid spillage, vermin infestation, software, use of consumables other than those approved by Sharp, or any alterations made to the product which are not authorised by Sharp.

Please retain your sales documentation, as this should be produced to validate a warranty claim.

This warranty is in addition to and in no way limits, varies or excludes any express and implied rights and remedies under any relevant legislation in the country of sale. However, to the extent permitted by such legislation, Sharp excludes any liability for any indirect or consequential damages arising from the purchase or use of the product.

To the extent permitted by law, Sharp excludes all implied warranties and conditions and where the product is one that is not normally required for personal, domestic or household use, Sharp limits its liability to the repair or replacement (at Sharp's option) of materials or workmanship which are found by Sharp to be defective.

For your reference, please enter the particulars of your purchase below and retain, with your purchase documentation.

Model No. \_\_\_\_\_

Serial No. \_\_\_\_\_

Date of Purchase \_\_\_\_\_

Place of Purchase \_\_\_\_\_

SPform046 (Dec2001)

FOR LOCATION ENQUIRIES WITHIN  
**AUSTRALIA**  
REGARDING YOUR LOCAL  
SHARP APPROVED SERVICE CENTRE

CALL SHARP

LOCAL CALL: **1 300 135 022**  
FACSIMILE: (02) 9672 1210

WEB: [www.sharp.net.au](http://www.sharp.net.au)

SHARP CORPORATION OF AUSTRALIA PTY. LIMITED  
A.B.N. 40 003 039 405  
1 Huntingwood Drive, Huntingwood NSW 2148

Important Notice: This warranty applies only to products sold in Australia

Download from [Www.Somanuals.com](http://Www.Somanuals.com). All Manuals Search And Download.

---

# Introduction

Welcome, and thank you for choosing a SHARP fax machine and cordless handset.

In addition to the cordless handset that is included with the fax machine, up to five other cordless handsets can be used with the fax machine. The additional cordless handsets must support the DECT/GAP standard.

The FO-D60 base (fax machine) complies with the GAP (Generic Access Profile) standard and supports the following functions: Outgoing calls, incoming calls, intercom.

Additional bases and handsets must comply with the GAP standard.

## ***Fax machine and general specifications***

<b>Automatic dialling</b>	40 numbers
<b>Imaging film</b>	<b>Initial starter roll</b> (included with machine): 10 m (approx. 30 A4 pages) <b>Replacement roll</b> (not included): <b>FO-9CR</b> 60 m (one roll yields approx. 180 A4 pages)
<b>Memory size*</b>	448 KB (approx. 24 average pages with no voice messages recorded and ECM turned off, or 20 minutes of voice messages (including OGMs) with no documents in memory)
<b>Modem speed</b>	14,400 bps with automatic fallback to lower speeds.
<b>Transmission time*</b>	Approx. 6 seconds (only when ECM is on)
<b>Resolution</b>	<b>Horizontal:</b> 8 lines/mm <b>Vertical:</b> Standard: 3.85 lines/mm Fine /Halftone: 7.7 lines/mm Super fine: 15.4 lines/mm
<b>Automatic document feeder</b>	10 pages max. (A4, 80 g/m <sup>2</sup> paper)
<b>Recording system</b>	Thermal transfer recording

\*Based on Sharp Standard Chart at standard resolution is Sharp special mode, excluding time for protocol signals (i.e., ITU-T phase C time only).

<b>Halftone (grayscale)</b>	64 levels
<b>Compression scheme</b>	MR, MH, MMR
<b>Paper tray capacity (60 - 80 g/m<sup>2</sup> paper)</b>	Approx. 50 A4-size sheets (at room temperature; maximum stack height should not be higher than the line on the tray)
<b>Display</b>	16-digit LCD display
<b>Applicable telephone line</b>	Analog public switched telephone network
<b>Compatibility</b>	ITU-T (CCITT) G3 mode
<b>Input document size</b>	<b>Automatic feeding:</b> Width: 148 to 210 mm Length: 140 to 297 mm <b>Manual feeding:</b> Width: 148 to 210 mm Length: 140 to 600 mm
<b>Effective scanning width</b>	210 mm max.
<b>Effective printing width</b>	204 mm max.
<b>Contrast control</b>	Automatic/Dark selectable
<b>Reception modes</b>	TEL/FAX, TEL, FAX, A.M.
<b>Copy function</b>	Single / Multi (99 copies/page)
<b>Telephone function</b>	Yes (cannot be used if power fails)
<b>Power requirements</b>	230 - 240 V AC, 50 Hz
<b>Operating temperature</b>	5 - 35°C
<b>Humidity</b>	25 - 85 % RH
<b>Power consumption</b>	Standby: 3.2 W Maximum: 110 W
<b>Dimensions</b> (without attachments)	Width: 327 mm Depth: 193 mm Height: 163 mm
<b>Weight</b> (without attachments)	Approx. 2.8 kg

## ***Cordless handset specifications***

<b>Standard</b>	DECT (Digital Enhanced Cordless Telecommunications) GAP (Generic Access Profile)
<b>Frequency</b>	1.88 to 1.9 GHz
<b>Duplex operation</b>	TDMA (Time Division Multiple Access)
<b>Dimensions</b>	Width: 51 mm Depth: 29 mm Height: 145 mm
<b>Weight</b>	Approx. 130 g (with battery)
<b>Battery</b>	1.2 V Ni-MH battery; capacity: 630 mAh x 3 pcs (min. 600 mAh)
<b>Power consumption</b>	Approx. 1.0 W (in standby mode)
<b>Initial charging</b>	Approx. 12 hours for initial charge
<b>Battery life</b>	Approx. 10 hours (600 minutes) (at room temp.)
<b>Battery life in standby mode</b>	Approx. 120 hours with one full charge (at room temperature) <i>Battery life (both normal and in standby mode) may vary depending on usage, range from base machine, and environmental conditions such as temperature.</i>

As a part of our policy of continuous improvement, SHARP reserves the right to make design and specification changes for product improvement without prior notice. The performance specification figures indicated are nominal values of production units. There may be some deviations from these values in individual units.

## ***System PIN number***

Please fill in your system PIN in the space provided below. For information on the System PIN number, see page 57.

<input type="text"/>	<input type="text"/>	<input type="text"/>	<input type="text"/>
----------------------	----------------------	----------------------	----------------------

## ***Important safety information***

For your safety, if any of your equipment is not operating properly or should any physical damage occur to the equipment where internal parts may become exposed, the equipment should be immediately disconnected from the phone line and then the power line and returned to a SHARP authorised Service Centre for inspection, repair, or disposal.

Installing or modifying telephone lines should only be done by an ACA licensed serviceman.

This facsimile machine is designed for use in Australia only.

Do not disassemble this machine or attempt any procedures not described in this manual. Refer all servicing to qualified service personnel.

Do not install or use the machine near water, or when you are wet. For example, do not use the machine near a bath tub, wash bowl, kitchen sink or laundry tub, in a wet basement, or near a swimming pool. Take care not to spill any liquids on the machine.

Unplug the machine from the telephone socket and then the power outlet and consult a qualified service representative if any of the following situations occur:

- Liquid has been spilled into the machine or the machine has been exposed to rain or water.
- The machine produces odors, smoke, or unusual noises.
- The power cord is frayed or damaged.
- The machine has been dropped or the housing damaged.

Do not allow anything to rest on the power cord, and do not install the machine where people may walk on the power cord.

This machine must only be connected to a 230 - 240 V, 50 Hz, earthed (3-prong) outlet. Connecting it to any other kind of outlet will damage the machine and invalidate the warranty.

Never insert objects of any kind into slots or openings on the machine. This could create a risk of fire or electric shock. If an object falls into the machine that you cannot remove, unplug the machine and consult a qualified service representative.

Do not place this machine on an unstable cart, stand or table. The machine could be seriously damaged if it falls.

Never install telephone wiring during a lightning storm.

Never install telephone sockets in wet locations unless the socket is specifically designed for wet locations.

Never touch bare telephone wires or terminals unless the telephone line has been disconnected at the network interface.

Use caution when installing or modifying telephone lines.

Avoid using a telephone (other than a cordless type) during an electrical storm. There may be a remote risk of electric shock from lightning.

Do not use a telephone to report a gas leak in the vicinity of the leak.

The power outlet must be installed near the equipment and must be easily accessible.

**WARNING NOTICE:**

**NO** calls can be made to or from this fax machine during a mains power failure.

**WARNING:** Australian Communications Authority (ACA) regulations state that no unauthorised changes or modifications to this equipment are permitted.

**Note:** Complies with ACA standard AS/NZSCISPR22 regarding emission of electromagnetic interference.

These limits are designed to provide reasonable protection against interference in an installation. This equipment generates, uses, and can radiate radio frequency energy and, if not installed and used in accordance with the instructions, may cause interference. However, there is no guarantee that interference will not occur in a particular installation.

If this equipment does cause interference to radio or television reception, which can be determined by turning the equipment off and on, the user is encouraged to try to correct the interference by one or more of the following measures:

- Reorient or relocate the receiving antenna.
- Increase the separation between the equipment and the receiver.
- Connect the equipment to an outlet on a different circuit to that which the receiver is connected.
- Consult the dealer or an experienced radio/TV technician for help.

The Ringer Equivalence Number (REN) for this equipment is written on the back of the machine. The sum of all Ringer Equivalence Numbers (REN's) on your telephone line should not exceed 3 to assure correct service from your telephone company.

## **Batteries**

Use only the batteries specified in this manual. Use only the provided charger to charge the batteries.

Do not use new and old batteries together. Do not use different types of batteries together.

When replacing batteries, make sure that the "+" and "-" sides are placed correctly.

Do not mutilate the batteries. Corrosive fluid may leak out and cause injury or burns to the eyes and skin. The fluid may be toxic if swallowed. In case of contact with eyes, flush with clean water (do not rub), and seek medical attention immediately.

Do not store or carry a battery with other metal objects such as keys or pins. These may short the battery and cause it to overheat.

Do not allow a battery to become wet.

Do not dispose of a battery in a fire or heat a battery. The battery may explode.

Do not let children replace the batteries.

Do not attempt to recharge a non-rechargeable battery.

## **Health care facilities and equipment**

Radio frequency energy emitted from the cordless handset equipment may cause medical equipment to malfunction. Verify that any personal medical equipment you are using is adequately shielded from external radio frequency energy before using the cordless handset equipment. Do not use the cordless handset equipment in health care facilities where such use is prohibited.

**Important:** This fax machine is not designed for use on a line which has call waiting, call forwarding, or certain other special services offered by your telephone company. If you attempt to use the fax machine in conjunction with any of these services, you may experience errors during transmission and reception of facsimile messages. The fax machine is not compatible with digital telephone systems.



---

# ***Table of Contents***

<b>A Look at the Operation Panel</b>	<b>9</b>
<hr/>	
<b>1. Installation</b>	<b>15</b>
<hr/>	
Unpacking Checklist . . . . .	15
Setting Up . . . . .	16
Loading the Imaging Film . . . . .	24
Loading Printing Paper . . . . .	26
Entering Your Name and Fax Number . . . . .	28
Setting the Date and Time . . . . .	30
Setting the Reception Mode . . . . .	32
Volume Adjustment - Fax Machine . . . . .	33
<b>2. Using the Cordless Handset</b>	<b>35</b>
<hr/>	
About the Cordless Handset System . . . . .	35
Making a Phone Call . . . . .	36
Receiving a Phone Call . . . . .	37
Receiving a Fax Using the Cordless Handset . . . . .	38
Storing and Using Auto-Dial Numbers . . . . .	38
Dialling From the Incoming/Outgoing Call List (Redial) . . . . .	44
Using the Intercom Feature . . . . .	45
Transferring Calls . . . . .	47
Adjusting the Ringing Melody and Volume . . . . .	50
Other Features . . . . .	52
Registering Cordless Handsets . . . . .	55
<b>3. Using the Answering System</b>	<b>63</b>
<hr/>	
Recording an Outgoing Message . . . . .	63
Operating the Answering System . . . . .	64
Optional Answering System Settings . . . . .	68
Transfer Function . . . . .	70
Remote Operations . . . . .	74
<b>4. Sending Faxes</b>	<b>81</b>
<hr/>	
Transmittable Documents . . . . .	81
Loading the Document . . . . .	82

## Table of Contents

Adjusting the Resolution and Contrast . . . . .	83
Sending a Fax by Normal Dialling. . . . .	85
Sending a Fax by Automatic Dialling . . . . .	87
Sending a Fax From Memory . . . . .	94
<b>5. Receiving Faxes</b>	<b>96</b>
Using TEL/FAX Mode . . . . .	96
Using A.M. Mode . . . . .	97
Using FAX Mode . . . . .	98
Using TEL Mode . . . . .	99
Optional Reception Settings . . . . .	102
Substitute Reception to Memory . . . . .	104
<b>6. Making Copies</b>	<b>105</b>
<b>7. Special Functions</b>	<b>107</b>
Caller ID (Requires Subscription to Service) . . . . .	107
Distinctive Ring (Requires Subscription to Service) . . . . .	112
Blocking Reception of Unwanted Faxes . . . . .	113
Polling (Requesting a Fax Transmission) . . . . .	114
<b>8. Printing Lists</b>	<b>115</b>
<b>9. Maintenance</b>	<b>118</b>
Replacing the Cordless Handset Batteries . . . . .	121
<b>10. Troubleshooting</b>	<b>123</b>
Problems and Solutions . . . . .	123
Messages and Signals . . . . .	129
Clearing Paper Jams . . . . .	134
<b>Quick Reference Guide</b>	<b>136</b>
<b>Index</b>	<b>138</b>

# A Look at the Operation Panel

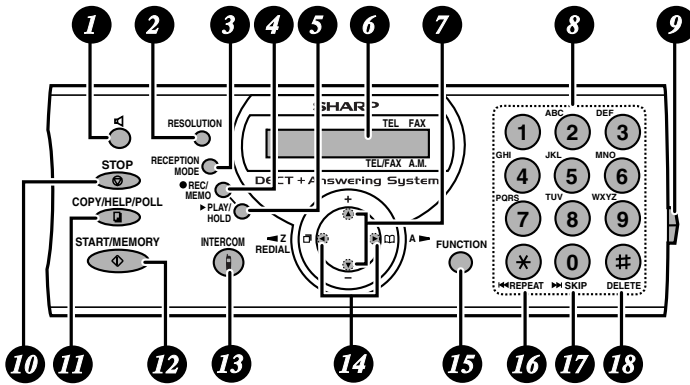

- 1**  **key**  
Press this key to listen to the line and fax tones through the speaker when faxing a document (page 85).
- 2** **RESOLUTION key**  
Press this key to adjust the resolution for faxing or copying (page 83).
- 3** **RECEPTION MODE key**  
Press this key to select the reception mode (an arrow in the display will point to the currently selected reception mode; page 32).
- 4** **REC/MEMO key**  
Press this key to record an outgoing message, phone conversation, or memo (pages 63 and 67).
- 5** **PLAY/HOLD key**  
Press this key to play recorded messages (page 66), or to place a call on hold (page 101).
- 6** **Display**  
This displays messages and prompts to help you operate the machine.

**7****UP and DOWN arrow keys**

**Enlarge/reduce setting:** When making a copy of a document, press these keys to select an enlarge/reduce setting (page 105).

**Volume setting:** When a document is not in the feeder, press these keys to

change the speaker volume when the  key has been pressed, or the ringer volume at any other time (page 34).

**FUNCTION key settings:** Press these keys after pressing the **FUNCTION** key to scroll through the FUNCTION MODE settings.

**8****Number keys**

Use these keys to dial numbers, and enter numbers and letters when storing auto-dial numbers.

**9****Panel release**

Press this release to open the operation panel.

**10****STOP key**

Press this key to cancel an operation before it is completed.

**11****COPY/HELP/POLL key**

Press this key to make a copy of a document (page 105). Press this key to print out the Help List, a quick reference guide to the operation of the fax machine. This key is also used after dialling to poll (request fax transmission from) another machine (page 114).

**12****START/MEMORY key**

Press this key after dialling to begin fax transmission (page 85). Press this key before dialling to send a fax through memory (page 95).

**13****INTERCOM key**

Press this key to page or locate the cordless handset.

**14****Left and right arrow keys**

**Auto-dial numbers:** When sending a fax or making a phone call, press these keys to scroll through your auto-dial numbers (page 90), the "REVIEW CALLS" list (only available if you have Caller ID; page 109), and the last number dialled (redial; page 92).

**FUNCTION key settings:** Press the right arrow key after scrolling with the up and down arrow keys to select a **FUNCTION** key setting.

**15****FUNCTION key**

Press this key followed by the arrow keys to select special functions and settings.

**16****REPEAT key**

Press this key while listening to a message to play it again (page 66).

**17****SKIP key**



Press this key while listening to a message to skip to the next message (page 66).

**18****DELETE key**

Press this key to erase recorded messages (page 67).

### ***Monitoring phone conversations***

When speaking through the handset, you can press  to allow a third person to listen to the conversation through the speaker. (To turn off the speaker, press the key again.)

To adjust the volume of the speaker when monitoring a conversation, press  or  (the volume reverts to the lowest setting each time the handset is replaced).

Note that **the speaker cannot be used for speaking**; it is only for listening.

To avoid feedback (a loud howling sound), be sure to turn off the speaker (press  once again) before you replace the handset.

## Cordless handset

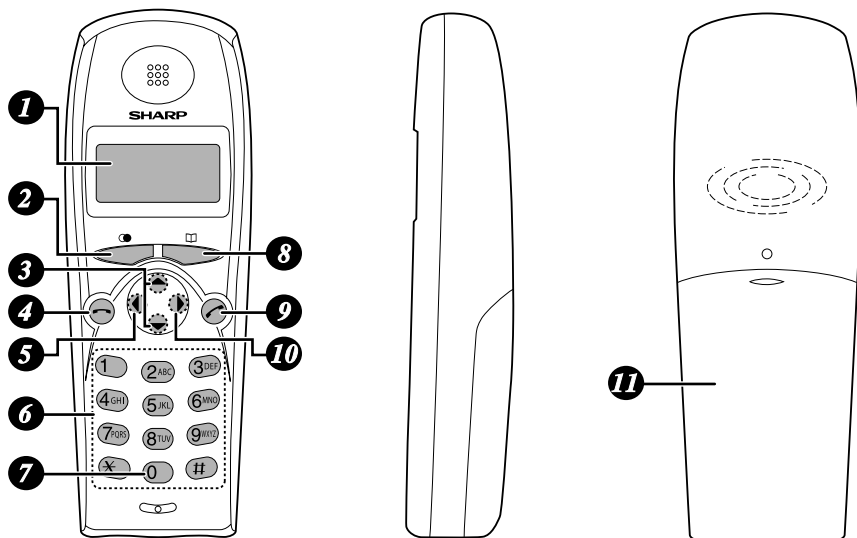





1

### Display

This displays messages and prompts to help you use the cordless handset.

2

### Call key

Press  and then  or  to scroll through the most recent calls made and received on the cordless handset (received calls will only appear if you have Caller ID). If you have Caller ID, you can hold down  to access the Caller ID list in the fax machine. During a phone conversation, this key can be pressed to issue a flash signal. If you are on a flash-type PBX, this key can be used to dial out.

3

### Up arrow key and Down arrow key

**Receiver volume:** When talking on the cordless handset, press these keys to adjust the receiver volume.

**Scroll through option settings:** When not talking on the cordless handset, press these keys to scroll through the option settings. To select a setting, press .

**4**  **key**

Press this key to end a call. To turn off the power of the cordless handset, hold down this key until the display goes blank.

**5**  **key**

Use this key to clear an entry, or to move back to the previous level in the settings. Press this key during a call to put the other party on hold.



**6** **Number keys**

Use these keys to dial numbers, and enter numbers and letters when storing auto-dial numbers.

**7**  **key**

When entering an auto-dial number, hold this key down until a hyphen appears to insert a pause between digits.

**8**  **key**

Use this key to search for an auto dial number (press  and then  or  to scroll through your auto-dial numbers). If you hear a fax tone when you answer a call, press this key to begin fax reception.

**9**  **key**

Press this key to make or answer a call. To turn on the power of the cordless handset when it is off, hold down this key until the display turns on .

**10**  **key**

Press this to select settings and complete entries when programming information in the cordless handset.

**11** **Battery cover**

Remove this cover to install or replace the handset battery.

## Icons in the cordless handset display

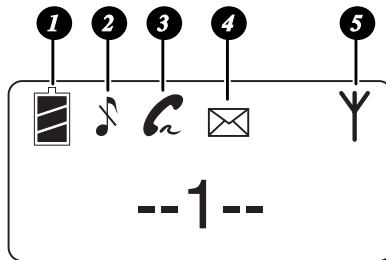

- 1** This indicates how much power is left in the batteries.
- 2** This indicates that the cordless handset ringer (and the beeps that sound when keys are pressed) are turned off (silent ring).
- 3** This appears when  is pressed on the cordless handset, and blinks when a call comes in.
- 4** This appears when new messages have been received in the fax machine's answering system. The envelope flap opens when there are only old messages.
- 5** This appears when the cordless handset and the fax machine are able to communicate.

## Characters that appear in the cordless handset display

1	2	3	4	5	6	7	8	9	0
1	2	3	4	5	6	7	8	9	0
A	B	C	D	E	F	G	H	I	J
A	B	C	D	E	F	G	H	I	J
K	L	M	N	O	P	Q	R	S	T
K	L	M	N	O	P	Q	R	S	T
U	V	W	X	Y	Z	*	-	pause	#
U	V	W	X	Y	Z	*	--	--	□
?	_								
□	_								

Note that lower case letters in the fax machine display will appear as upper case letters in the cordless handset display, and a letter with an umlaut will appear as a space. In addition, the following characters appear differently in the fax machine and cordless handset displays:

Fax machine	.	/	!	~	#	\$	%	&	'
Cordless handset		/			□				
Fax machine	(	)	*	+	,	-	:	;	<
Cordless handset	{	}	*			--			↔
Fax machine	=	>	?	@	[	¥	]	^	_
Cordless handset	--	↔	□		{	}			_
Fax machine	`	{		}					
Cordless handset									

□ :space



# 1. Installation

## Unpacking Checklist

Before setting up, make sure you have all of the following items.

◆ If any are missing, contact your dealer or retailer.

Paper tray

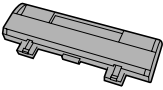

Paper tray extension

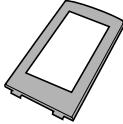

Operation manual

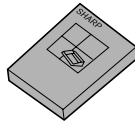

Gears (2)



Adapter

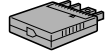

Handset



Handset cord

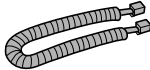

Telephone line cord

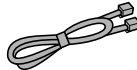

Imaging film  
(initial starter roll)

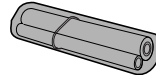

Cordless handset



Battery cover



Rechargeable batteries (3)



Cordless handset charger

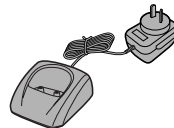

## Setting Up

### Selecting a location for the fax machine

To maximize the talking range of the cordless handset, we recommend installing the fax machine in a high and central location away from obstructions such as walls.

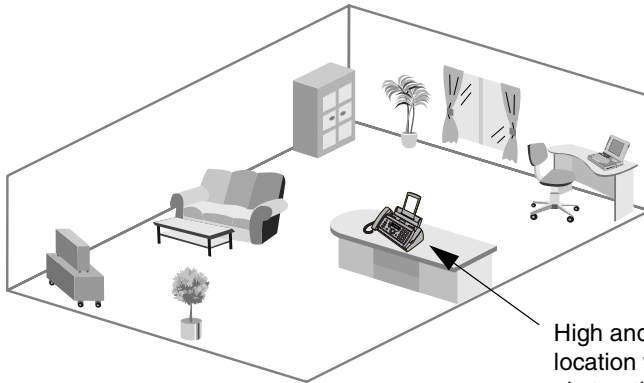

High and central location with no obstructions

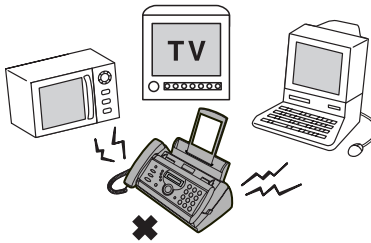

Keep the fax machine away from other electrical appliances such as TVs, microwave ovens, computers, and other cordless phones.

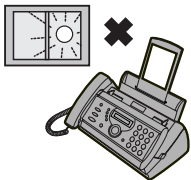

Do not place the machine in direct sunlight.

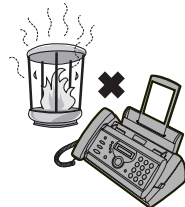

Do not place the machine near heaters or air conditioners.

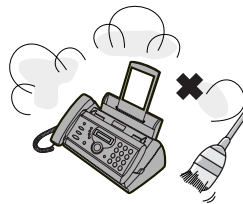

Keep dust away from the machine.

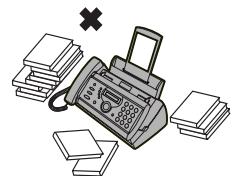

Keep the area around the machine clear.

## Connecting the handset

Connect the handset as shown and place it on the handset rest.

- ◆ The ends of the handset cord are identical, so they will go into either jack.

Make sure the handset cord goes into the jack marked with a handset symbol on the side of the machine!

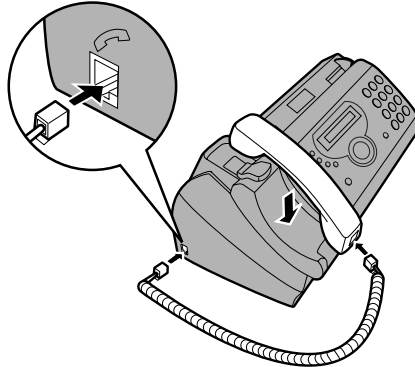

Use the handset to make ordinary phone calls, or to transmit and receive faxes manually.

## Connecting the power cord

Plug the power cord into a 230 - 240 V, 50 Hz, earthed AC (3-prong) outlet.

- ◆ When disconnecting the fax, unplug the telephone line cord before unplugging the power cord.
- ◆ Caution: The power outlet must be installed near the equipment and must be easily accessible.

The machine does not have a power on/off switch, so the power is turned on and off by simply plugging in or unplugging the power cord.

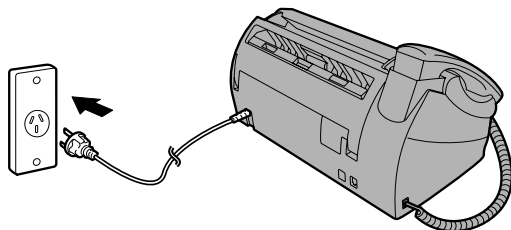

## Connecting the telephone line cord

Insert one end of the telephone line cord into the adapter. Insert the other end of the line cord into the socket on the back of the machine marked **TEL. LINE**. Plug the adapter into the telephone socket on the wall.

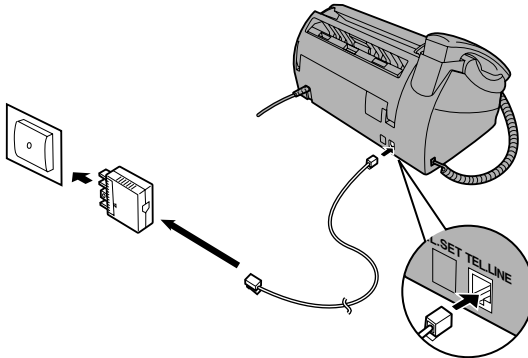

Be sure to insert the line into the **TEL. LINE** socket. **Do not** insert it into the **TEL. SET** socket!

### Setting the dial mode:

The fax machine is set for tone dialling. If you are on a pulse dial line, you must set the fax machine for pulse dialling. Press the keys on the operation panel as follows:

**1** Press **FUNCTION** once and **▲** twice.

Display:

OPTION SETTING ◀▶

**2** Press **▶** once and **▼** twice.

DIAL MODE ▶▶

**3** Press **▶** once.

1=TONE, 2=PULSE

**4** Select the dial mode:

TONE: (1) PULSE: (2)

The display briefly shows your selection, then:

PSEUDO RING ▶▶

**5** Press **STOP** to exit.

## Moving your fax and reconnecting

Should it be necessary to move your fax to a new location, first disconnect the telephone line cord before disconnecting the power lead. When reconnecting, it is necessary to connect the power lead before connecting the telephone line cord.

### Note:

If your area experiences a high incidence of lightning or power surges, we recommend that you install surge protectors for the power and telephone lines. Surge protectors can be purchased from your dealer or at most electronics shops.

## Attach the paper tray and paper tray extension

Attach the paper tray.

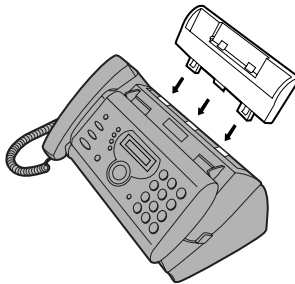

Attach the paper tray extension.

Insert  
horizontally  
and rotate up

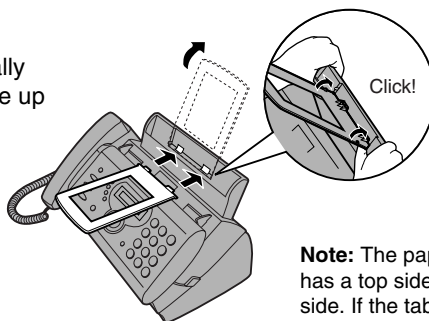

**Note:** The paper tray extension has a top side and a bottom side. If the tabs do not go into the holes, turn the support over.

### About condensation

If the machine is moved from a cold to a warm place, it is possible that condensation may form on the scanning glass, preventing proper scanning of documents for transmission. To remove the condensation, turn on the power and wait approximately two hours before using the machine.

## Extension phone (optional)

If desired, you can connect an extension phone to the **TEL. SET** socket on the fax.

- 1 Remove the seal covering the TEL. SET socket.**

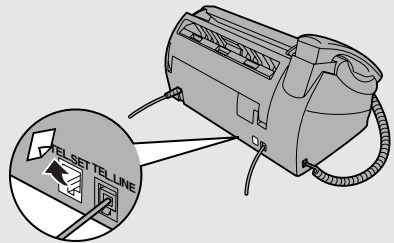

- 2 Connect the extension phone line to the TEL. SET socket.**

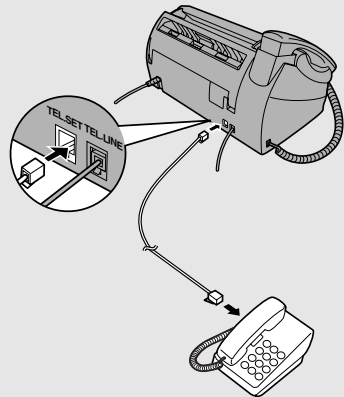

## Connecting the cordless handset charger

- 1 Plug the AC adapter into a standard 230-240 V AC outlet.

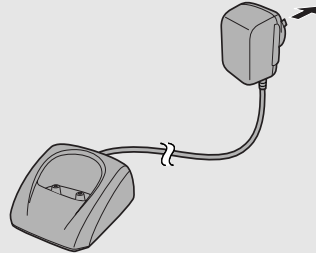

**Important:** Never cover the charger and AC adapter with a blanket, cloth, or other material. Excessive heating may result and cause fire.

## Installing the batteries and charging the cordless handset

- ◆ Be sure to read the battery precautions on page 5.

- 1 Insert the batteries into the cordless handset, making sure that the “+” and “-” sides are placed correctly.

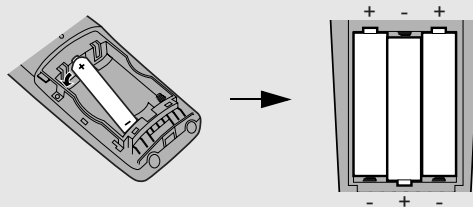

- 2 Place the battery cover on the cordless handset, making sure it snaps firmly into place.

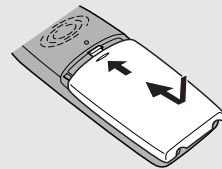

**3 Place the cordless handset in the charger with the dial pad facing forward.**

- **Important!** The dial pad must face forward, or the batteries will not charge.
- The batteries charge automatically while the cordless handset is in the charger. While charging, the display

shows:

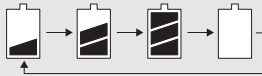

When charging is finished, the battery

icon appears full: 

- The cordless handset and charger may feel warm while charging. This is normal.

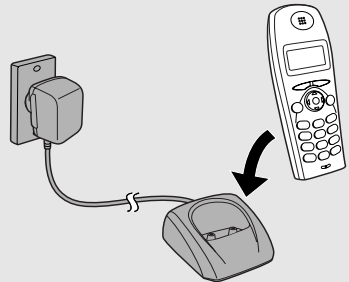

Charge the batteries at least **12** hours the first time!

- ◆ The batteries cannot be overcharged. When not using the cordless handset, keep it in the charger to ensure that it is always charged.
- ◆ When the batteries need charging,  will blink in the display and you will hear beeps during a phone conversation. If you need to continue the conversation, transfer the call to the fax machine or another cordless handset (see page 47). Place the cordless handset in the charger and let it charge.

**Note:** If the batteries are extremely low, nothing may appear in the display during the first several minutes that the cordless handset is in the charger. The battery will begin to charge normally after several minutes.

- ◆ To ensure that the battery charges properly, wipe the charger contacts once a month with a cotton swab.



**Talking range**

The talking range of the cordless handset is approximately 200 m (line of sight; talking range may decrease depending on transmission conditions). If you hear noise or interference while talking on the cordless handset, move closer to the fax machine.

Large metal objects, metal structures, and thick walls reduce the talking range.

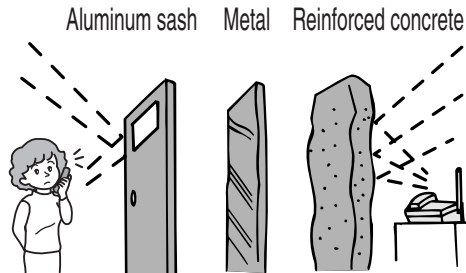

## Loading the Imaging Film

Your fax uses a roll of imaging film to create printed text and images. The print head in the fax applies heat to the imaging film to transfer ink to the paper. Follow the steps below to load or replace the film.

- ◆ The initial starter roll of imaging film included with the machine can print about 30 A4-size pages.
- ◆ When replacing the film, use a roll of SHARP **FO-9CR** imaging film. One roll can print about 180 A4-size pages.

### Important!

If the wrong type of film is loaded, printing will not be possible.

### Near end of film detection:

At approximately 3 m from the end of the imaging film (approximately 10 pages can still be printed), "NEAR END OF FILM / REPLACE FILM" will appear in the display. This alerts you that you will soon need to replace the film. Correct operation of this function is only guaranteed when SHARP **FO-9CR** imaging film is used.

- 1** Remove the paper from the paper tray and open the operation panel (press **1**).

If you are loading the imaging film for the first time, go to Step 4.

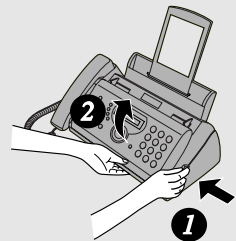

- 2** Remove the used film and empty spool.

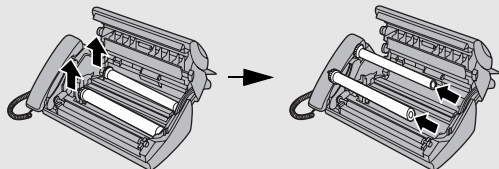

- 3** Remove the two green gears from the spools. **DO NOT DISCARD THE TWO GREEN GEARS!**

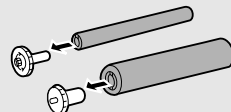

#### 4 Remove the new roll of imaging film from its packaging.

- Cut the band that holds the rolls together.

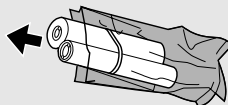

#### 5 Insert the green gears.

Make sure the gears fit into the slots in the ends of the rolls.

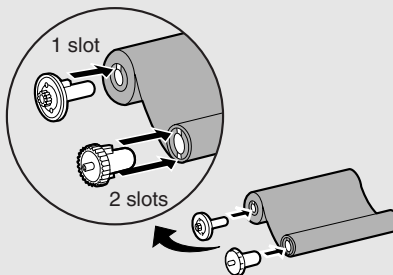

#### 6 Insert the film into the print compartment.

Fit ends of rolls onto hubs

Thick roll to rear

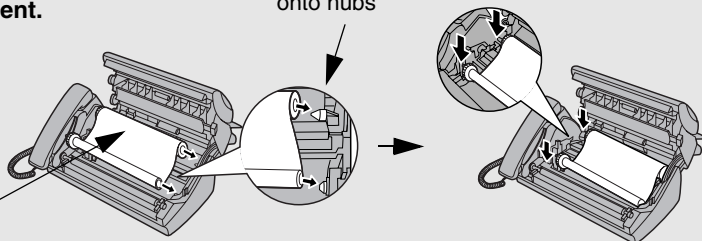

#### 7 Rotate the front gear as shown until the film is taut.

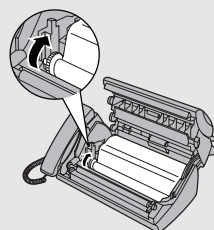

#### 8 Close the operation panel (press down on both sides to make sure it clicks into place).

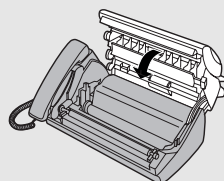

## Loading Printing Paper

You can load up to 50 sheets of A4-size, 60 - 80 g/m<sup>2</sup> paper in the paper tray (at room temperature; maximum stack height should not be higher than the line on the tray).

- 1 Fan the paper, and then tap the edge against a flat surface to even the stack.**

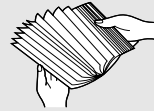

- 2 Insert the stack of paper into the tray, PRINT SIDE DOWN.**

- If paper remains in the tray, take it out and combine it into a single stack with the new paper.
- Be sure to load the paper so that printing takes place on the **print** side of the paper. Printing on the reverse side may result in poor print quality.
- **GENTLY LOAD THE PAPER IN THE PAPER TRAY.**
- **DO NOT FORCE THE PAPER DOWN INTO THE FEED SLOT.**

The stack should not be higher than this line.  
(This line is the reference position for the maximum number of sheets. If sheets are above this line, press down with your finger. If the some sheets remain above this line after this, please remove.)

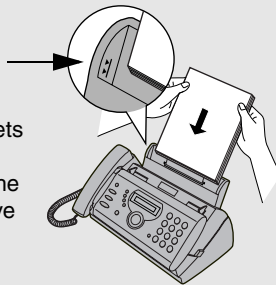

**Note:** Do not use paper that has already been printed on, or paper that is curled.

**Note:** If at any time the display shows the alternating messages at right, check the printing paper. If the tray is empty, add paper. If there is paper in the tray, take it out and then reinsert it.

When you are finished, press **START/MEMORY** 

ADD PAPER &



PRESS START KEY

## Print contrast setting

Your fax has been set at the factory to print at normal contrast. If desired, you can change the print contrast setting to LIGHT.

**1** Press  once and  twice. Display: OPTION SETTING 

**2** Press  once and  twice. PRINT CONTRAST 

**3** Press  once. 1:NORMAL

**4** Select the print contrast:  
 NORMAL: 1 LIGHT: 2 The display briefly shows your selection, then: COPY CUT-OFF 

**5** Press  to return to the date and time display.

## Entering Your Name and Fax Number

Before you begin sending faxes, enter your name and fax (telephone) number as explained below and set the date and time as explained on page 30.

Once you enter this information, it will automatically appear at the top of each fax page you send.

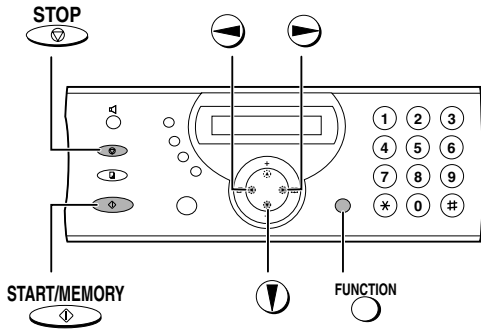

**1** Press **FUNCTION** once and **STOP** 3 times.

Display:

ENTRY MODE

**2** Press **START/MEMORY** once.

OWN NUMBER SET

**3** Press **START/MEMORY** once.

ENTER FAX #

























































**4** Enter your fax number by pressing the number keys (max. 20 digits).

- To insert a space between digits, press **#**. To enter a "+", press **\***.
- To clear a mistake, press **STOP**.

**5** Press **START/MEMORY**  to enter the fax number in memory.

**6** Enter your name by pressing number keys for each letter as shown in the chart below. Up to 24 characters can be entered.

Example: SHARP = 7777 44 2 777  7

SPACE = 	G = 	N =  	U =  
A = 	H =  	O =   	V =   
B =  	I =   	P = 	W = 
C =   	J = 	Q =  	X =  
D = 	K =  	R =   	Y =   
E =  	L =   	S =    	Z =    
F =   	M = 	T = 	

◆ To enter two letters in succession that require the same key, press  after entering the first letter.

◆ To clear a mistake, press .

◆ To enter a lower case letter, continue pressing the key for the letter until the lower case letter appears. To enter one of the following symbols, press

 or  repeatedly:

. / ! " # \$ % & ' ( ) \* + , - : ; < = > ? @ [ ¥ ] ^ \_ ' { | } → ←

**7** Press **START/MEMORY** 

Display:

DATE&TIME SET 

**8** Press **STOP**  to return to the date and time display.

## Setting the Date and Time

The date and time appear in the display and are printed at the top of every page you fax. Set the date and time as shown below.

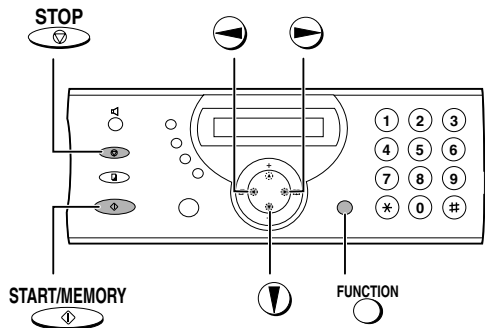

**1** Press **FUNCTION** once and **▼** 3 times. Display: ENTRY MODE ↔

**2** Press **▶** once and **▼** once. DATE&TIME SET ↔

**3** Press **▶** once. The currently set date appears (example): DATE 15-02-2003



**4** Enter a two-digit number for the day ("01" to "31").

Example: the 5<sup>th</sup> 0 5 → DATE 05-02-2003

- To correct a mistake, press **◀** to move the cursor back to the mistake and then enter the correct number.



- 5** Enter a two-digit number for the month (“01” for January, “02” for February, “12” for December, etc.).

Example: January   →

- 6** Enter the year (four digits).

Example: 2004     →

The currently set time appears (example):

- 7** Enter a two-digit number for the hour (“00” to “23”) and a two-digit number for the minute (“00” to “59”).

Example: 9:25     →

- 8** Press  to start the clock. →

- 9** Press  to return to the date and time display.



## Volume Adjustment - Fax Machine

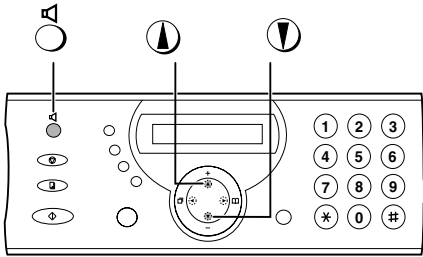

You can adjust the volume of the speaker and ringer using the up and down arrow keys.

**Note:** To adjust the volume of the cordless handset receiver, see page 36. To adjust the volume of the cordless handset ringer, see page 50.

### Speaker

**1** Press .

**2** Press  or  to select the desired volume level.

- Press  again to turn off the speaker.

## ***Fax machine ringer***

**1** Press  or  to select the desired volume level.

(Make sure  has not been pressed, and a document is not loaded in the feeder.)

- The ringer rings once at the selected level, and then the date and time reappear in the display.

Display:

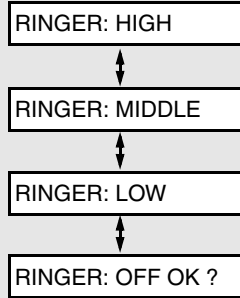

**2** If you selected “RINGER: OFF OK ?” to turn off the ringer, press  .

**Note:** When the reception mode is set to TEL, the ringer will still ring at LOW if turned off.

## 2. Using the Cordless Handset

### About the Cordless Handset System

#### Additional cordless handsets

In addition to the cordless handset that is included with the fax machine, up to five other cordless handsets can be used with the fax machine. The additional cordless handsets must support the DECT/GAP standard.

The FO-D60 base (fax machine) complies with the GAP (Generic Access Profile) standard and supports the following functions: Outgoing calls, incoming calls, intercom. Additional bases and handsets must comply with the GAP standard.

**Note:** Due to the wide variety of GAP handsets of different manufacture and specifications, full functionality with the FO-D60 cannot be guaranteed.

- ◆ To add a cordless handset, it must be registered in the fax machine. See page 55.

#### Additional bases

One cordless handset can be used with up to four bases. By purchasing additional bases, the range of use of the cordless handset can be expanded. (Note that once a cordless handset receives a call, it must remain within the communication range of the base that is transmitting the call.)

- ◆ A call can only be transferred from a cordless handset to the base that it is currently using, or to another cordless handset that is using the same base.
- ◆ To use a cordless handset with additional bases, the cordless handset must be registered in each of those bases. See page 55.

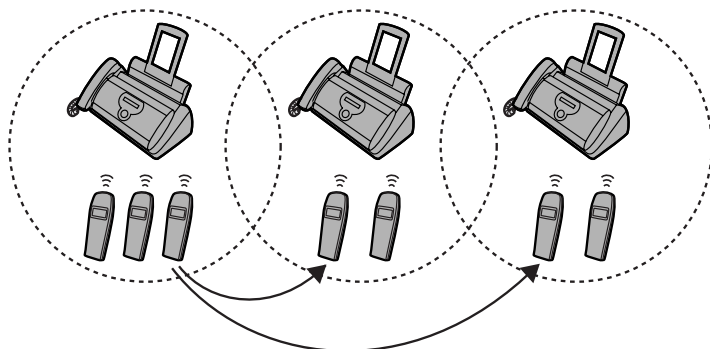

## Making a Phone Call

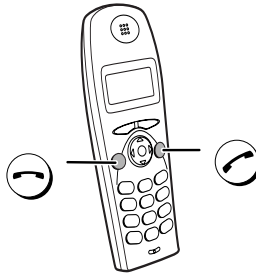

**1** Pick up the cordless handset and press .

-  appears in the display.
- **Note:** If the cordless handset display shows BUSY, you must wait until the fax machine is no longer in use to use the cordless handset.



**2** When you hear the dial tone, dial the number.





**3** When you are ready to end the call, press .



- If the END CALL setting is set to “ON” (see page 53), you can also end the call by simply placing the cordless handset in the charger.

### Cordless handset receiver volume

To adjust the volume of the cordless handset receiver when talking on the cordless handset, press  or .

You can also dial by entering the phone number first and then pressing .

- ◆ Check the number in the display before pressing . If there is a mistake, press  to clear the mistake and then enter the correct digits.

**Note:** If a pause is needed between any of the digits to access an outside line or a special service, hold down  until “” appears.



## Receiving a Phone Call

- 1** When the cordless handset rings, pick it up and press  to answer. Talk to the other party.

- 2** When you are ready to end the call, press .

- If the END CALL setting is set to “ON” (see page 53), you can also end the call by simply placing the cordless handset in the charger. (The call will end even if it has been placed on hold.)

## Putting a Call on Hold

To put the other party on hold during a call, press . While the call is on hold, “C” will blink in the display. When you are ready to resume the call, press  once again.

- ◆ If the END CALL setting is set to “ON” (see page 53), placing the cordless handset in the charger will end the call, even if the call is on hold.
- ◆ If the END CALL setting is set to “OFF”, placing the cordless handset in the charger will not break the connection while a call is on hold, and thus phone charges may continue to apply.

## Receiving a Fax Using the Cordless Handset

If you hear a fax tone after answering a call on the cordless handset, or if the other party speaks to you and then wants to send a fax, press . This signals the fax machine to begin fax reception.

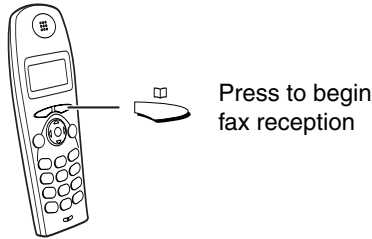

**Note:** If the fax machine detects a fax signal after you answer a call on the cordless handset, it will begin reception automatically.

## Storing and Using Auto-Dial Numbers

You can store your most frequently dialed numbers for automatic dialling. Numbers can be stored in the cordless handset or in the fax machine. To store a number in the cordless handset, follow the steps below.

- ◆ Up to 20 numbers can be stored in the “phone book” in the cordless handset. Numbers stored in the cordless handset can only be used by the cordless handset.
- ◆ To store a number in the fax machine, see page 87. The cordless handset can also use numbers that are stored in the fax machine.

**1** Press .

Cordless handset display:

1 PHONE BK

**2** Press .











11 NEW





**3** Press .

NAME?

**4** Enter a name for the auto-dial number. To enter each letter, hold down the key for the letter as shown in the chart below until the letter appears in the display. Up to 8 characters can be entered. (If you do not wish to enter a name, go directly to Step 5.)



SPACE, PAUSE (—), - = 	M, N, O = 	# (□), ?, _ = 
A, B, C = 	P, Q, R, S = 	
D, E, F = 	T, U, V = 	
G, H, I = 	W, X, Y, Z = 	
J, K, L = 	* = 	

◆ To clear a mistake, press . To clear all the entered letters, hold down .

**5** Press .

NUMBER?

**6** Enter the number by pressing the number keys. Up to 24 digits can be entered. (Note: A space cannot be entered.)

- To clear a mistake, press . To clear all the entered numbers, hold down .
- If a pause is needed between any of the digits to access an outside line or a special service, hold down  until “—” appears. Several pauses can be entered in a row.

**7** Press .

DONE



**8** Return to Step 2 to store another number, or press  repeatedly to exit.







## ***Dialling an auto-dial number***

---

**1** Press  once.

---

**2** Press  or  until the auto-dial number that you wish to dial appears in the display (the name will appear, or the number if no name was stored).

- To go directly to names that begin with a certain letter, hold down the number key with that letter until the letter appears in the display, and then press  until the desired name appears.
  - To check the number of a name in the display, press .
  - If you wish to dial an auto-dial number that is stored in the fax machine, press  until BASE appears in the display, press , and then press  or  until the desired number appears. (Note that an auto-dial number in the fax machine that includes an “R” will not appear.)
- 



**3** Press .

- The number is automatically dialed.



## Quick Search

You can also quickly dial an auto dial number by entering the first 3 letters of the name.

**1** Enter the first 3 letters of the name of the auto dial number that you wish to dial. To enter each letter, hold down the number key with the desired letter until the letter appears in the display.

- If you do not wish to enter all 3 letters, you can press  and then enter one letter. (If a different name appears in the display, press  or  until the desired name appears.)

**2** The name of the auto-dial number that begins with those 3 letters appears. (If there is no name that begins with those letters, the closest name will appear).

- If the correct name does not appear, press  or  until it appears.

**3** Press .

- The number is automatically dialed.

## Editing an auto-dial number

If you need to make changes to a previously stored auto-dial number, follow these steps:

**1** Press .

Cordless handset display:

1 PHONE BK

**2** Press  and then .

12 EDIT



**3** Press .

- The name of one of your stored auto-dial numbers appears.

**4** Press  or  until the name of the number that you wish to edit appears in the display.





**5** Press .

**6** Edit the name.

- Press  to delete letters (hold down  to delete all the letters). Press the number keys to enter new letters (see Step 4 on page 39).
- If you do not wish to change the name, go directly to Step 7.

**7** Press .

**8** Edit the number.

- Press  to delete digits (hold down  to delete all digits). Press the number keys to enter new digits.
- If a pause is required between any of the digits to access a special service or an outside line, hold down  until “” appears.

- If you do not wish to change the number, go directly to Step 9.

**9** Press .

DONE

**10** Press  repeatedly to exit.

### ***Deleting an auto-dial number***

If you need to delete an auto-dial number, follow these steps:

**1** Press .

Cordless handset display:



1 PHONE BK

**2** Press  and then .

13 DELETE

**3** Press .

- The name of one of your stored auto-dial numbers appears.

**4** Press  or  until the number that you wish to delete appears in the display.

**5** Press .

DONE



**6** Press  repeatedly to exit.

## Dialling From the Incoming/Outgoing Call List (Redial)

The cordless handset keeps a list of the most recent calls that you have made and received on the cordless handset. You can view this list and automatically dial a number in the list.



- ◆ **Important:** Received calls only appear in the list if you subscribe to a Caller ID service and have activated the Caller ID function (see page 107).
- ◆ If you subscribe to a Caller ID service and have activated the Caller ID function, you can also view the Caller ID list that is kept in the fax machine. (This list shows the most recent 30 calls received by the fax machine; see page 109.)

### 1 To view the incoming/outgoing call list in the cordless handset, press

 (do not hold  down). (Note: You can also hold down  until the first number in the list appears in the display.)

To view the Caller ID list in the fax machine, hold down  until "CALLS" (and then a name) appears in the display.

### 2 Press or until the name that you wish to call appears.

- If you are viewing the Caller ID list, you can press  or  to check the number of a name that appears in the display. To check the time of the call, press .

### 3 Press . The number is automatically dialed.

- To exit the list without calling a number, press  repeatedly.

**Note:** If the Caller ID information consists of only the name and not the number of the caller, the call will not appear in the cordless handset display.

## Deleting all calls from the incoming/outgoing list

To delete all calls from the incoming/outgoing list in the cordless handset, follow the steps below. (To erase all calls from the Caller ID list, see page 110.)

**1** Press  twice.

Cordless handset display:

2 CALLS

**2** Press  once.

21 DELETE

**3** Press  to delete the calls.

- To cancel, press .

**4** Press  to repeatedly to exit.

## Using the Intercom Feature

You can use the fax machine and cordless handsets as an intercom system.

- ◆ It may not be possible to page another cordless handset or the fax machine when other cordless handsets or the fax machine are already in use.

## Paging the fax machine or another cordless handset from a cordless handset

**1** Enter the number (1 to 6) of the cordless handset that you wish to page, or press  to page all cordless handsets.

Cordless handset display  
(example of paging the fax machine)

0

To page the fax machine, press .

- If the number of the cordless handset or fax machine (0 to 6) is stored in the cordless handset's phonebook with a name, the name will appear when you enter the number.

**2** Press .

-  appears in the display.



**3** The paged device rings and the other person answers.

**4** Talk with the other person. When you are ready to end the conversation, press .

### ***Paging a cordless handset from the fax machine (cordless handset locator)***

You can use this procedure to page a cordless handset, or locate a handset in the event that you misplace it.

**1** Pick up the fax machine handset.

**2** Press <sup>INTERCOM</sup>  on the fax machine, and enter the number of the cordless handset that you wish to page. (Press  to page all cordless handsets.)

Example: 

Fax machine display:

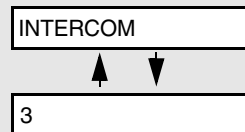

**3** The selected cordless handset rings.

- This allows you to locate the cordless handset if you have misplaced it.

**4** The other person presses  on the cordless handset to answer.

**5** Talk with the other person. When you are ready to end the conversation, replace the handset.



**If a call comes in while the Intercom feature is being used**

If an outside call comes in while you are using the Intercom feature, the person who wishes to take the call should first stop the Intercom call (press



on the cordless handset or replace the fax machine handset), and then

answer the outside call (press  on the cordless handset or pick up the fax machine handset).

## Transferring Calls

You can transfer a call to the fax machine or to a cordless handset.

### Transferring a call from a cordless handset to the fax machine

**Note:** It is not possible to talk with the person who answers on the fax machine before transferring a call.

**1** During the call, press  on the cordless handset (the call is put on hold).

**2** Press  to transfer the call to the fax machine.

- To cancel the transfer and return to the initial caller, press .

**3** Press .

- When the transfer is complete, the display will return to the standby display.
- If nobody answers within 30 seconds, all cordless handset will start ringing. If nobody answers within the next 30 seconds, the call will be disconnected.

## ***Transferring a call from a cordless handset to another cordless handset***

---



**1** During the call, press  on the cordless handset (the call is put on hold).

---

**2** Enter the number of the handset, or press  to page all cordless handsets (this does not include the fax machine).

- To cancel the transfer and return to the initial caller, press .
- 

**3** Press .

- You can speak to the person who answers on the cordless phone. When finished, press  to complete the transfer.
- To complete the transfer without speaking to the person who answers, press .
- If nobody answers, press  to return to the initial caller.

## Transferring a call from the fax machine to a cordless handset

**Note:** A call can only be transferred once.

**1** During the call, press **INTERCOM**  on the fax machine.

- The numbers of cordless handsets that are registered in the fax machine will appear.

Fax machine display:

PRESS HANDSET #



1 2 3 4 5 6

**2** Enter the number of the cordless handset to which you wish to transfer the call. (Press  to page all cordless handsets.)

Example: 



Fax machine display:

CALL TRANSFER



3







**3** The selected cordless handset rings and the other person answers. Replace the fax machine handset to complete the transfer.

- Note:** You will not be able to hear the sound of the cordless handset ringing through the fax machine handset.
- If nobody answers, press **INTERCOM**  or **STOP**  to return to the initial caller.

## Adjusting the Ringing Melody and Volume



You can select one of six ringing melodies for the cordless handset, as well as adjust the ringer volume or turn it off.

### Selecting a ringing melody

<b>1</b> Press  3 times.	Cordless handset display: <input type="text" value="3 RING"/>
<b>2</b> Press  once.	<input type="text" value="31 MELODY"/>
<b>3</b> Press  once.	<input type="text" value="1"/>
<b>4</b> Enter the number (from 1 to 6) of the desired melody (or press  or  until the desired number appears and press  ).	<input type="text" value="DONE"/>
<ul style="list-style-type: none"><li>The selected melody will sound. To select a different melody, repeat steps 3 and 4.</li></ul>	
<b>5</b> Press  repeatedly to exit.	

### Adjusting the ringer volume



<b>1</b> Press  3 times.	Cordless handset display: <input type="text" value="3 RING"/>
---	--

**2** Press  once and then  once.

32 VOLUME

**3** Press  once.

3

**4** Press  or  to select a volume level from 1 to 4 and then press .  
(You can also simply enter the number of the desired volume level.)

DONE

**5** Press  repeatedly to exit.

### Turning off the cordless handset ringer

If you do not wish the cordless handset to ring when a call is received (or to sound a beep when a key is pressed), follow these steps to turn the ringer off.

When this is done,  will appear in the display.

**1** Press  3 times.

Cordless handset display:

3 RING

**2** Press  once and then  twice.

33 SILENT

**3** Press  once.

OFF









**4** Press  or  to select ON or OFF and then press .

DONE

**5** Press  repeatedly to exit.

## Turning beep sounds on and off



A beep normally sounds when you press a key on the cordless handset. To turn the beep sounds on or off, follow these steps.

<b>1</b> Press  3 times.	Cordless handset display: <input type="text" value="3 RING"/>
<b>2</b> Press  once and then  once.	<input type="text" value="34 BEEPS"/>
<b>3</b> Press  once.	<input type="text" value="ON"/>
<b>4</b> Press  or  to select ON or OFF and then press  .	<input type="text" value="DONE"/>
<b>5</b> Press  repeatedly to exit.	

## Other Features

### Call time

To check the duration of your most recent call, follow these steps:

<b>1</b> Press  twice.	Cordless handset display: <input type="text" value="2 CALLS"/>
<b>2</b> Press  once and then  once.	<input type="text" value="22 TIME"/>

**3** Press  once. The duration appears.

**4** Press  repeatedly to exit.

### End call setting

When this setting is turned on, calls can be ended by simply replacing the handset in the charger (there is no need to press ). (A call will end even if it has been placed on hold.)

**1** Press  3 times.

Cordless handset display:

4 SET

**2** Press  once.

41 END CALL



**3** Press  once.

**4** Press  or  to select ON or OFF and then press .

DONE



**5** Press  repeatedly to exit.

### Turning the cordless handset power on and off

To conserve battery power, you can turn the cordless handset off. To turn off the power, hold down  until the display goes blank. To turn the power on, hold down  until the display turns on. The power also turns on automatically when the cordless handset is placed in the charger.

## ***Listening to messages from the cordless handset***

When new messages have been received in the fax machine's answering system,  will appear in the display. To listen to the messages from your cordless handset, follow the steps below.

- ◆  changes to  after you listen to the messages.

**1** Press  once.





Cordless handset display:

6 ANSWER

**2** Press  once.

ANSWER

**3** Press  to play all messages in the answering system, or  to play only new messages.

- To repeat a message, press .
- To skip a message, press .
- To delete a message, press  while the message is playing.
- To stop playback, press .

**4** When finished, press  repeatedly to exit.



## Registering Cordless Handsets







In order to be used, a cordless handset must first be registered in the fax machine. The cordless handset that came with the fax machine is already registered. To register an additional cordless handset, follow the steps in *Automatic registration* or *Custom registration* on the following pages.

- ◆ Use automatic registration when you are only registering the cordless handset in one fax machine and the system PIN number has not been changed from its initial setting (0000) (see page 57). This is the easiest method of registration and does not require entering the System PIN number.
- ◆ Use custom registration when the system PIN number has been changed to a number other than 0000. The system PIN number must be entered during registration.
- ◆ A cordless handset can be registered in up to four fax machines. To register the cordless handset in multiple fax machines, repeat the custom registration procedure using each fax machine. To select which fax machine the cordless handset will normally be used with, see page 60.

### Automatic registration

Use automatic registration when you are only registering the cordless handset in one fax machine and the system PIN number has not been changed from its initial setting (0000).

#### On the fax machine

<b>1</b> Press  <b>once</b> and  <b>once.</b>	Fax machine display: <div style="border: 1px solid black; padding: 2px; display: inline-block;">DECT SETTING </div>
<b>2</b> Press  <b>once.</b>	<div style="border: 1px solid black; padding: 2px; display: inline-block;">HS ENTRY </div>
<b>3</b> Press  <b>once.</b>	<div style="border: 1px solid black; padding: 2px; display: inline-block;">PRESS START KEY</div>
<b>4</b> Press  .	<div style="border: 1px solid black; padding: 2px; display: inline-block;">WAITING HS ENTRY</div>

On the cordless handset

**5** Press  repeatedly until the display at right appears.

5 BASE

**6** On the cordless handset, press  3 times.

The cordless handset display changes as follows each time you press  :

51 REGIST

AUTO

□ □ □ □

**7** When registration is finished, the fax machine and cordless handset will show the messages at right. Note the number that is assigned to the cordless handset (“2” is shown as an example).

Fax machine display:

HS 2 REGISTERED

Cordless handset display:

REGIST



2

Press  on the fax machine to exit.

## Programming a system PIN



The system PIN is a 4-digit ID number that is used to prevent unauthorized registration of a cordless handset in a fax machine. When the system PIN is set to a number other than 0000 (the initial factory setting), a cordless handset must be registered using custom registration and the correct system PIN must be entered on the cordless handset during registration. Follow these steps to program a system PIN in the fax machine.

- ◆ To prevent other people from adding cordless handsets without your authorization, it is recommended that you change the system PIN to a number other than 0000. (Note that a cordless handset can be deleted without entering the system PIN.)

**1** On the fax machine, press  once and  once.

Fax machine display:

DECT SETTING  

**2** Press  once and  once.

SYSTEM PIN  

**3** Press  once.

OLD PASSWORD

**4** Enter the current system PIN (4 digits).

- The system PIN is initially set to 0000 at the factory.
- To clear a mistake, press  .

**5** Press  .

**6** Enter the new system PIN that you wish to program (4 digits).

**7** Press  .

**8** Enter the new system PIN once again for confirmation.

**9** Press  .

**10** Press  to return to the date and time display.

### Custom registration

Use this procedure to register a cordless handset when the system PIN in the fax machine has been set to other than 0000, or when you are registering the cordless handset in multiple fax machines..

#### On the fax machine

**1** Press  once and  once.

Fax machine display:

DECT SETTING 

**2** Press  once.

HS ENTRY 

**3** Press  once.

PRESS START KEY

**4** Press  .

WAITING HS ENTRY

#### On the cordless handset



**5** Press  repeatedly until the display at right appears.

Cordless handset display:

5 BASE

**6** Press  once.

51 REGIST

**7** Press  once and  once.

CUSTOM

**8** Press  once and then enter the number (1 to 4) that you would like to assign to the fax machine. (This number is used to identify the fax machine when the cordless handset is registered in multiple fax machines.)

CODE ?

**9** Enter the 4-digit system PIN number that is programmed in the fax machine.

**10** Press .

REGIST



1 2 3 4 5 6

**11** Enter the number that you would like to assign to the cordless handset.

**12** When registration is finished, the fax machine and cordless handset will show the messages at right (the handset number “2” is shown as an example).

Fax machine display:



HS 2 REGISTERED

Cordless handset display:

REGIST



2

Press  on the fax machine and  on the cordless handset to exit.

## Giving priority to a base



When a cordless handset is registered with multiple bases, use the following setting to select which base the cordless handset will normally be used with.

- ◆ The initial setting is NONE. When NONE is selected (or when the selected base is not powered on), the cordless handset will be used with the first base that is powered on.

**1** On the cordless handset, press  repeatedly until the display at right appears.

Cordless handset display:

5 BASE

**2** Press  once and  once.

52 PRIOR

**3** Press  once.

- NONE or the number of the currently selected fax machine appears in the display.

**4** Enter the number (1 to 4) of the base to be given priority. (The number is the number that was assigned to the base during custom registration of the cordless handset.)

To select NONE, press .



(Entering a number that has not been assigned will have no effect.)

**5** Press repeatedly  to exit.

## Cordless handset display language



Use this setting to select the language used in the cordless handset display.

◆ This setting is selected on the fax machine.

**1** On the fax machine, press **FUNCTION**  **once** and  **once.**

Fax machine display:

DECT SETTING 

**2** Press  **once** and  **twice.**

HS LANGUAGE 

**3** Press  **once.**



**4** Press  **or**  **until the desired language appears in the display.**

**5** Press **START/MEMORY** .

**6** Press **STOP**  **to return to the date and time display.**



## Deleting a cordless handset

Follow these steps if you need to delete a cordless handset (cancel the registration in the fax machine).

- 1** On the fax machine, press  once and  once.

Fax machine display:



DECT SETTING 

- 2** Press  once and  once.

HS DELETE 

- 3** Press  once.

PRESS HANDSET #

   
1 2 3 4 5 6

- 4** Enter the number of the cordless handset that you wish to delete.

- 5** Press .

- 6** Press  to return to the date and time display.



# 3. Using the Answering System

The built-in answering system allows you to receive both voice messages and faxes while you are out.

- ◆ To use the answering system, you will first need to record an outgoing message. When you go out, turn on the answering system by setting the reception mode to A.M.

## Recording an Outgoing Message

The outgoing message (OGM) is the greeting that the machine plays after answering a call to inform callers that they can leave a message or send a fax. Follow the steps below to record a message.

### Example:

“Hello. You've reached \_\_\_\_\_. No one is available to take your call right now. Please leave a message after the beep or press your facsimile Start key to send a fax. Thank you for calling.”

**1** Press  once and  once.

Display:

OGM1(GENERAL) 

**2** Press  once.

LIFT HANDSET OR



PLAY: PLAYBACK

**3** Lift the handset.

(If you have already recorded a message, you can press  to listen to the message.)



**4** Press **START/MEMORY**  and speak into the handset to record a message.

- The outgoing message can be up to 60 seconds long. While recording, the display will show the time left to record.

**5** When finished, replace the handset or press **STOP**  .

### ***To listen to the outgoing message***

To listen to the outgoing message, follow Steps 1 and 2 of the above procedure and then press **▶PLAY/HOLD**  . Note that the general outgoing message cannot be erased. If you need to change it, simply repeat the recording procedure.

## ***Operating the Answering System***

### ***Activating the answering system***

To turn on the answering system so that callers can leave messages, press **RECEPTION MODE**  until the arrow in the display points to A.M.

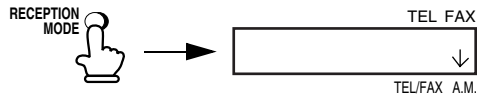

- ◆ The outgoing message will play (you can stop playback by pressing

**STOP**  ).

- ◆ It will not be possible to set the reception mode to A.M. if an outgoing message has not been recorded.

**Note:** In A.M. mode, the machine will automatically switch to fax reception if it detects six seconds of silence after answering a call. For this reason, if a caller pauses for this length of time while leaving a message, they will be cut off.

### Number of rings in A.M. mode (Toll Saver function)

The number of rings on which the machine answers incoming calls in A.M. mode depends on whether the Toll Saver function is turned on, and if it is on, whether you have messages.

- ◆ The Toll Saver function is initially turned on.

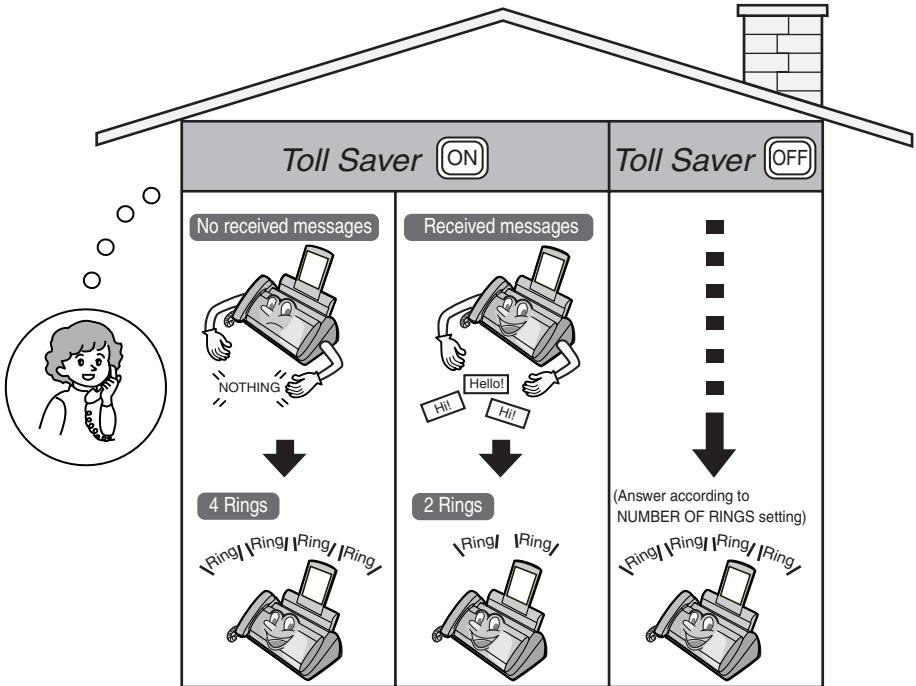

To turn off the Toll Saver function, see page 74.

To adjust the NUMBER OF RINGS setting, see page 98.



## ***Listening to received messages***

When you return, the display will show the number of messages recorded. Follow the steps below to listen to your messages.

### **1 Press .**

- If you only want to listen to new messages (messages not previously listened to), continue to hold  down for at least two seconds.

### **2 The messages will play.**





- As each message plays, the date and time of recording will appear briefly in the display. If no messages were received, NO MESSAGES will appear.
- **Repeat:** To listen to a message a second time, press  before playback of that message ends. To move back to the previous message, press  within 3 seconds of the beginning of the current message.
- **Skip:** To skip forward to the next message, press .

**Note:** Playback will stop if you receive a call, lift the handset, or press .

- ◆ You can also listen to the messages from the cordless handset. See page 54.
- ◆ You can print out a list of your received messages that shows the date and time that each was received. See page 115.





## Erasing received messages

It is important to erase received messages after you listen to them to ensure that the memory does not become full.



- ◆ **Erasing all messages:** To erase all messages, press **FUNCTION** , **#**  **DELETE**, and then **START/MEMORY** .
- ◆ **Erasing a single message:** To erase a single message, press **#**  **DELETE** while the message is being played.

## Recording memos

You can record memos for yourself and other users of the machine. These will be played back together with incoming messages when the **▶PLAY/HOLD**  key is pressed.

- 1** Press **●REC/MEMO**  once and **▶**  once.
- 2** Pick up the handset, press **START/MEMORY** , and speak into the handset.
- 3** When you have finished speaking, replace the handset or press **STOP** .

## Recording phone conversations (2-way recording)

To record a phone conversation, hold down the **●REC/MEMO**  key during the conversation you wish to record. When you are finished, release the key. The conversation will be played back when the **▶PLAY/HOLD**  key is pressed.

**Note:** Intercom conversations cannot be recorded.

## Optional Answering System Settings

### Setting ICM time

Incoming messages (ICMs) are the messages which callers leave for you on the built-in answering system. The answering system is set at the factory to allow each caller a maximum of 4 minutes to leave a message. If desired, you can change this setting to 15, 30, or 60 seconds.

**1** Press **FUNCTION** once and **▼** once.

Display:

A.M. SETTING 

**2** Press **▶** once and **▼** once.

RECORDING TIME 

**3** Press **▶**.

**4** Press a number from 1 to 4 to select the desired ICM recording time.

**1** 15 seconds

**3** 60 seconds

**2** 30 seconds

**4** 4 minutes

The display briefly shows your selection, then:

REMOTE CODE 

**5** Press **STOP** to return to the date and time display.











### FAX mode on A.M. failure

If the memory for recording incoming messages becomes full while you are out, the answering system will no longer be able to record messages. The ON A.M. FAILURE setting is used to choose the response of the machine to incoming calls when this happens:

- ◆ **YES** (switch to FAX mode): The reception mode will switch to FAX mode, allowing the machine to continue to receive faxes automatically. With this setting, you can still use the remote commands to listen to your messages and then erase them (see *Remote Operations* on page 74).







- ◆ NO (do not switch to FAX mode): The machine will answer after 20 rings, after which it will wait to receive a remote command. Most callers will hang up before it answers; however, when you call the machine from a remote location, you can wait until it answers, listen to your messages, and then erase them (see *Remote Operations* on page 74).

The initial setting is NO . If you want to change the setting to YES, press the panel keys as follows:

<b>1</b> Press  once and  once.	Display: <div style="border: 1px solid black; padding: 2px; display: inline-block;">A.M. SETTING </div>
<b>2</b> Press  once and  twice.	<div style="border: 1px solid black; padding: 2px; display: inline-block;">ON A.M. FAILURE </div>
<b>3</b> Press  .	<div style="border: 1px solid black; padding: 2px; display: inline-block;">1=YES, 2=NO</div>
<b>4</b> Press  to select YES (switch to FAX mode), or  to select NO.	The display briefly shows your selection, then: <div style="border: 1px solid black; padding: 2px; display: inline-block;">OGM ONLY MODE </div>
<b>5</b> Press  to return to the date and time display.	



### OGM only mode

If needed, you can turn off recording of incoming messages. In this case, your outgoing message will play, but callers will not be able to leave a message. (The machine will still receive faxes sent by automatic dialling.)

<b>1</b> Press  once and  once.	Display: <div style="border: 1px solid black; padding: 2px; display: inline-block;">A.M. SETTING </div>
<b>2</b> Press  once and  once.	<div style="border: 1px solid black; padding: 2px; display: inline-block;">OGM ONLY MODE </div>

**3** Press .

1=YES, 2=NO

**4** Press  to turn on OGM only mode,  
or  to turn it off.

The display briefly shows  
your selection, then:

TOLL SAVER 

**5** Press  to return to the date and time display.

## Transfer Function

The Transfer function is used to have the machine automatically call you at a specified number every time it receives an incoming message. This lets you hear your messages immediately after they come in, even when you are at a remote location.

To use the Transfer function, you must first program the number that you wish the machine to call (the transfer number), and record the transfer message that plays when you answer the phone at the remote location.

When you go out and wish to use the transfer function, turn it on. When you return and no longer wish to use the transfer function, turn it off.



### Programming the transfer number

To use the Transfer function, you must first give the machine the number to call (the transfer number).

**1** Press  once and  once.

Display:

A.M. SETTING 

**2** Press  once and  3 times.

TRANSFER TEL # 

**3** Press .

ENTER TEL #





**4 Press the number keys to enter the transfer number.**

- To insert a pause between any two digits of the number, press  .

**5 Press  .****6 Press  to return to the date and time display.****Recording the transfer message**

The transfer message plays when you answer the telephone, and informs you that the call is a transfer call. It can be up to 15 seconds long. To record a transfer message, follow the steps below. The following is an example:

“Hello. This is a transfer call for (YOUR NAME). Enter your remote code number now.”

**1 Press  once and  twice.**

Display:

OGM2(TRANSFER) **2 Press  once.****3 Lift the handset.**

(If you have already recorded a message, you can press  to listen to the message, or press

 to delete the message.)

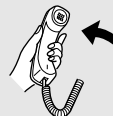



**4** Press **START/MEMORY**  and speak into the handset to record the message.

- The transfer message can be up to 15 seconds long. While recording, the display will show the time left to record.

**5** When finished, replace the handset or press **STOP** .

### Checking or erasing the transfer message

To check or erase the transfer message, follow Steps 1 and 2 of the above procedure, and then press **▶PLAY/HOLD**  to check the message, or **#**  to erase the message.



### Turning the Transfer function on and off

When you go out and wish to use the Transfer function, turn it on as follows:

**1** Press **FUNCTION**  once and **▼**  once.

Display:

A.M. SETTING 

**2** Press **▶**  once and **▲**  3 times.

TRANSFER FUNC 

**3** Press **▶** .

1=YES, 2=NO

**4** Press **1**  to turn on the Transfer function.

The display briefly shows your selection, then:

(Press **2**  to turn the function off.)

ON A.M. FAILURE 

**5** Press **STOP**  to return to the date and time display.

**6** Each time the machine receives an incoming message, it will call your programmed transfer number. When you answer, you will hear your recorded message telling you that the call is a transfer call. On the dial pad of your phone, enter **#**, your remote code number (see page 74), and **#**. The machine will play back your messages.

- You can also perform any of the remote operations described in *Remote Operations* later in this chapter (see page 74).









**Note:** When you hang up after a transfer call, the machine will not immediately resume normal operation. If you want the machine to accept calls immediately after a transfer call, enter **\*** twice before hanging up (if you want to hang up during message playback, first enter **0** and **#** to stop playback, then enter **\*** twice).

## Remote Operations

When you are out, you can call the machine from any tone dial telephone and play back your messages using the remote commands. You can also use these commands to change the reception mode and other settings.

### Remote code number

To access the machine to perform remote operations, you must first enter your remote code number. The remote code number has been set to "001" at the factory. If you wish to use a different number, follow these steps:











<b>1</b> Press  once and  once.	Display: <div style="border: 1px solid black; padding: 2px; display: inline-block;">A.M. SETTING </div>
<b>2</b> Press  once and  twice.	<div style="border: 1px solid black; padding: 2px; display: inline-block;">REMOTE CODE </div>
<b>3</b> Press  .	
<b>4</b> Press the number keys to enter a 3-digit remote code number.	
<b>5</b> Press  to store the remote number, and then  to return to the date and time display.	

### Toll Saver

When you call the machine to listen to your messages, it will answer after two rings if it has received at least one message, or after four rings if it has not received any messages.

This allows you to save money on telephone charges, particularly if you are calling long distance. If the machine does not answer after the second ring, you can simply hang up before it answers, saving yourself the cost of that call.

If you do not want to use the Toll Saver function, you can turn it off by following the steps below. In this case, the machine will answer after the number of rings set with the NUMBER OF RINGS setting (see *Changing the number of rings* on page 98).

<b>1</b> Press  once and  once.	Display: <div style="border: 1px solid black; padding: 2px;">A.M. SETTING </div>
<b>2</b> Press  once.	<div style="border: 1px solid black; padding: 2px;">TOLL SAVER </div>
<b>3</b> Press  once.	<div style="border: 1px solid black; padding: 2px;">1=YES, 2=NO</div>
<b>4</b> Press  to turn on the Toll Saver function, or  to turn it off.	The display briefly shows your selection, then: <div style="border: 1px solid black; padding: 2px;">RECORDINGTIME</div>
<b>5</b> Press  to return to the date and time display.	

## Retrieving your messages

**1** Call the machine from a tone dial telephone. When your outgoing message begins, press  on the telephone.

- You will hear a short beep, and the outgoing message will stop.

---

## 2 Enter your remote code number and then press **#**.

- You will hear a series of beeps equal to the number of messages recorded, or one long beep if four or more messages have been received. The machine will then play back the messages, beeping once at the end of each message. When all messages have been played back, you will hear a long beep.
- If no messages have been received, you will hear a short beep. You can either hang up, or perform any of the operations described in the following section, *Other remote operations*.

---

## 3 While the messages are playing, you can do any of the following:

- **Repeat:** To listen to a message a second time, press **2** and **#** on the telephone before that message ends. To move back to the previous message, press **2** and **#** during the first 3 seconds of the current message.
- **Skip forward:** To skip forward to the next message, press **5** and **#** on the telephone.
- **Stop:** To stop playback, press **0** and **#** on the telephone. After this, you can enter any of the commands described in the following section, *Other remote operations*.
- **Play new messages:** To listen to only your new messages, first stop playback by pressing **0** and **#**, and then press **6** and **#**.
- **Erase a message:** To erase the message you are currently listening to, press **3** and **#** before it ends.

#### 4 When you have finished listening to your messages, you can do any of the following:

- **Erase all messages:** Press **3**, **3**, and **#**.
- **Repeat playback:** Press **7** and **#**.
- **Perform other operations:** You can enter any of the commands described in the following section, *Other remote operations*.
- **Hang up:** If you do not erase your messages first, they will be saved and any new messages will be recorded after them. If you want the machine to resume normal operation immediately, press **\*** twice before hanging up (in some cases, particularly when the Transfer function is used, the machine may not accept new calls for one or two minutes after you hang up unless you press **\*** twice).

**Note:** You can also call the machine and perform remote operations when the reception mode is set to FAX. In this case, when you call the machine, press **#** immediately after it answers (before you hear the fax tone), and then continue from Step 2 above.

#### Comments:

- ◆ When a remote command is accepted by the machine, you will hear one beep. If an incorrect command is entered, you will hear four beeps. In the latter case, re-enter the correct command.
- ◆ When entering a command, do not pause longer than 10 seconds between each digit. If you do, you will hear a 4-beep error signal and the digits entered up to that point will be cleared. In this case, re-enter the command from the beginning.
- ◆ If you pause for longer than 10 seconds before entering a command, or make two errors while entering your remote code number, the line will be disconnected. (This prevents unauthorized people from attempting to guess your remote code number.)

### ***Other remote operations***

After listening to your messages, you can perform any of the following operations by pressing the appropriate keys on the telephone.

**Note:** The following commands cannot be entered while messages are being played back. If you do not want to wait until playback ends to enter a command, first stop playback by pressing **0** and **#**, and then enter the command.

### ***Changing the fax reception mode***

Select a new reception mode by pressing the keys as follows:

◆ **A.M. mode:** **8**, **1**, and **#**.

◆ **FAX mode:** **8**, **2**, and **#**.

◆ **TEL mode:** **8**, **3**, and **#**.

**Caution:** If you select TEL mode, you will not be able to change the reception mode again.

◆ **TEL/FAX mode:** **8**, **4**, and **#**.

### ***Recording a new outgoing message***

---

**1** Press **4** and **\*** on the telephone.

---

**2** When you hear a short beep, speak into the telephone to record the new message.

- The message can be up to 15 seconds long. After 15 seconds (or earlier if the machine detects silence after you finish speaking), you will hear a beep, and the new message will be played back.



## ***Turning the Transfer function on or off***

**To turn Transfer on:** Press **9**, **1**, and **#** on the telephone.

**To turn Transfer off:** Press **9**, **2**, and **#** on the telephone.

## ***Changing the transfer telephone number***

---

**1** Press **9**, **0**, and **#** on the telephone.

---

**2** After you hear a short beep, enter the new telephone number. When finished, press **#**.

- To insert a pause between any two digits of the number, press **\***.

## ***Recording a new transfer message***

---

**1** Press **9**, **3**, and **#** on the telephone.

---

**2** When you hear a short beep, speak into the telephone to record the new message.

- The time for the transfer message is fixed at 15 seconds. After 15 seconds (or earlier if the machine detects silence after you finish speaking), you will hear a beep, and the new message will be played back automatically.

## ***Recording a memo***

You can record a memo for yourself or other users of the machine. The memo will be played back when incoming messages are listened to.

---

**1** Press **\*** and **#** on the telephone.

---

**2** When you hear a short beep, speak into the telephone to record the memo.

---

**3** When you are finished, press **0** and **#** on the telephone.

- If the machine detects silence, it will stop recording automatically.

## ***OGM only mode***

**To turn on OGM only mode:** Press **1**, **1**, and **#** on the telephone.  
(Your outgoing message will play, but callers will not be able to record a message. Faxes sent by automatic dialling will be received)

**To turn off OGM only mode:** Press **1**, **2**, and **#** on the telephone.

# 4. Sending Faxes

## Transmittable Documents

### Size and weight

The size and weight of documents that you can load in the document feeder depend on whether you load one page at a time or several pages at once.

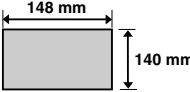
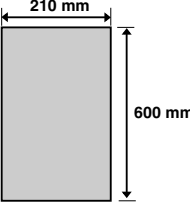
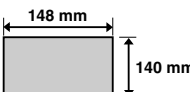
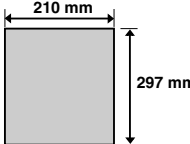
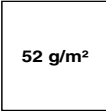
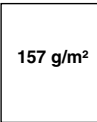
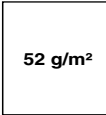
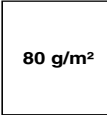
Loading one page at a time:		Loading up to 10 pages at once:	
Minimum size	Maximum size	Minimum size	Maximum size
			
Minimum weight	Maximum weight	Minimum weight	Maximum weight
			

**Note:** Letters or graphics on the edges of a document will not be scanned.

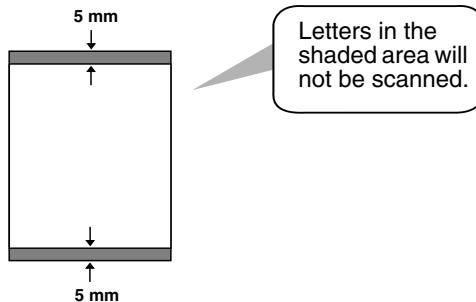

### ***Other restrictions***

- ◆ The scanner cannot recognise yellow, greenish yellow, or light blue ink.
- ◆ Ink, glue, and correcting fluid on documents must be dry before they pass through the document feeder.
- ◆ All clips, staples, and pins must be removed from documents before loading in the feeder. If these are not removed, they may damage the machine.
- ◆ Documents which are patched, taped, torn, smaller than the minimum size, carbon backed, easily smudged, or have a slippery coated surface should be photocopied, and the copy loaded in the feeder.

### ***Loading the Document***

Up to 10 pages can be placed in the feeder at one time. The pages will automatically feed into the machine starting from the bottom page.

- ◆ If you need to send or copy more than 10 pages, place the additional pages gently and carefully in the feeder just before the last page is scanned. Do not try to force them in, as this may cause double-feeding or jamming.
- ◆ If your document consists of several large or thick pages which must be loaded one at a time, insert each page into the feeder as the previous page is being scanned. Insert gently to prevent double-feeding.

- 
- 1** Adjust the document guides to the width of your document.

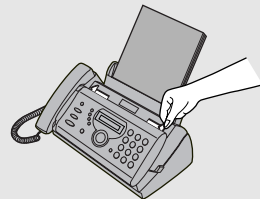

- 
- 2** Insert the document face down in the document feeder. The top edge of the document should enter the feeder first.

- READY TO SEND will appear in the display.

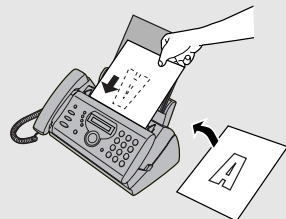

- 3** Adjust the resolution and/or contrast settings as explained in *Resolution and Contrast* below, then dial the receiving machine as explained on page 85.

## ***Adjusting the Resolution and Contrast***

If desired, you can adjust the resolution and contrast before sending a document.

- ◆ The default resolution setting is STANDARD and the default contrast setting is AUTO.
- ◆ You must adjust the settings each time you don't want to use the default settings.

**Note:** The resolution and contrast settings are only effective for sending a document. They are not effective for receiving a document.

### ***Resolution settings***

STANDARD	Use STANDARD for ordinary documents. This setting gives you the fastest and most economical transmission.
FINE	Use FINE for documents containing small letters or fine drawings.
SUPER FINE	Use SUPER FINE for documents containing very small letters or very fine drawings.
HALF TONE	Use HALF TONE for photographs and illustrations. The original will be reproduced in 64 shades of gray.

## Contrast settings

- |      |                                |
|------|--------------------------------|
| AUTO | Use AUTO for normal documents. |
| DARK | Use DARK for faint documents.  |

### 1 Load the document(s).

- The document must be loaded before the resolution and contrast can be adjusted.

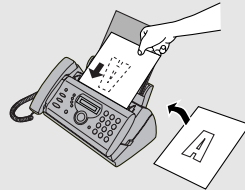

### 2 Press **RESOLUTION** one or more times until the desired resolution and contrast settings appear in the display.

- The first time you move through the list of resolution settings, the contrast setting AUTO will appear next to each resolution setting. The second time you move through the list, the contrast setting DARK will appear.

Display:

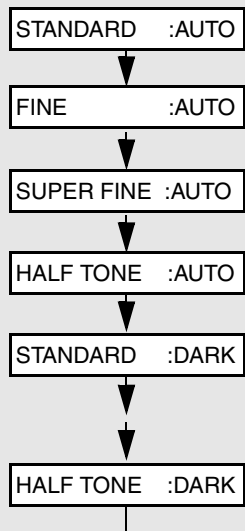

**Note:** In order to transmit in SUPER FINE resolution, the receiving fax machine must also have that resolution. If it doesn't, your machine will automatically step down to the next best available setting.

## ***Sending a Fax by Normal Dialling***

With Normal Dialling, you pick up the handset (or press ) and dial by pressing the number keys.

- ◆ If a person answers, you can talk with them through the handset before sending the fax. (If you pressed , you must pick up the handset to talk.)
- ◆ Normal Dialling allows you to listen to the line and make sure the other fax machine is responding.

### **1 Load the document(s).**

- If desired, press **RESOLUTION**  to set the resolution and/or contrast.

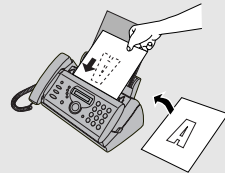

**READY TO SEND**

### **2 Pick up the handset or press . Listen for the dial tone.**

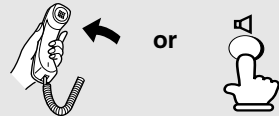

### **3 Dial the number of the receiving machine by pressing the number keys.**



---

**4 Wait for the connection. Depending on the setting of the receiving machine, you will either hear a fax tone or the other person will answer.**

- If the other party answers, ask them to press their Start key (if you pressed , pick up the handset to speak with them). This causes the receiving machine to issue a fax tone.

---

**5 When you hear the fax tone, press . Replace the handset." START/MEMORY**

- If the transmission is completed successfully, the fax will beep once.
- If an error occurs, the fax will beep three times and print a Transaction Report to inform you of the problem (see page 116).



**Note:**

If the transmission is unsuccessful and DOCUMENT JAMMED appears in the display, remove the document as explained on page 134. (This may occur if the other fax machine doesn't respond properly when you attempt to send the document.)





## ***Sending a Fax by Automatic Dialling***

You can store up to 40 fax or phone numbers in the machine for automatic dialling.

- ◆ Auto-dial numbers are dialled by pressing  until the desired number appears in the display, and then .

### ***Storing fax and phone numbers for automatic dialling***

**1** Press  once and  once.



Display:

**<NEW NUMBER>** 

**2** Press  once.

**ENTER FAX #**

























































**3** Enter the fax or voice number by pressing the number keys. Up to 32 digits can be entered. (Note: A space cannot be entered.)

- To clear a mistake, press .
- If a pause is required between any of the digits to access a special service or an outside line, press . The pause appears as a hyphen. Several pauses can be entered in a row.

**4** Press .

**5 Enter a name by pressing number keys for each letter as shown in the chart below. Up to 15 characters can be entered. (If you do not wish to enter a name, go directly to Step 6.)**



Example: SHARP = 7777 44 2 777  7

SPACE = 	G = 	N =  	U =  
A = 	H =  	O =   	V =   
B =  	I =   	P = 	W = 
C =   	J = 	Q =  	X =  
D = 	K =  	R =   	Y =   
E =  	L =   	S =    	Z =    
F =   	M = 	T = 	

◆ To enter two letters in succession that require the same key, press  after entering the first letter.

◆ To clear a mistake, press .

◆ To enter a lower case letter, continue pressing the key for the letter until the lower case letter appears. To enter one of the following symbols, press

 or  repeatedly:  
 ./! "# \$ % & ' ( ) \* + , - . : ; < = > ? @ [ \ ] ^ \_ ' { | } → ←

**6 Press**  .

Display:



**7 Return to Step 2 to store another number, or press**  **to return to the date and time display.**

• To confirm that an auto-dial number has been stored correctly, print out the Telephone Number List as explained on page 115.

**Note:** The fax machine uses a lithium battery to keep automatic dialling numbers and other programmed information in memory when the power is turned off. Battery power is consumed primarily when the power is off. With the power kept continuously off, the life of the battery is about 5 years. If the battery dies, have your dealer or retailer replace it. Do not try to replace it yourself.

## Editing and clearing auto-dial numbers

If you need to make changes to a previously stored auto-dial number, or clear a number, follow these steps:

**1** Press **FUNCTION** once and **▶** once.

Display:

<NEW NUMBER> ⬆⬇⬆

**2** Press **▲** or **▼** until the number you wish to edit or clear appears in the display.

**3** Press **▶** once.

1=EDIT, 2=CLEAR

**4** Select **EDIT** or **CLEAR**:

EDIT: **1** CLEAR: **2**

- If you selected CLEAR, go to Step 8.

**5** If you selected **EDIT**, make the desired changes to the number.

- Press **◀** or **▶** to move the cursor to the digit or digits you wish to change, and then enter the new digit. The new digit will replace the old digit.
- If you do not wish to change the number, go directly to Step 6.

**6** Press **START/MEMORY**.

**7** Make the desired changes to the name.

- Press **◀** or **▶** to move the cursor to the letter or letters you wish to change, and then press the appropriate number key repeatedly until the desired letter appears (see Step 5 on page 88). The new letter will replace the old letter.
- If you do not wish to change the name, go directly to Step 8.

**8** Press **START/MEMORY**  .

**9** Return to Step 2 to edit or clear another number, or press **STOP**  to return to the date and time display.

### **Using an auto-dial number**



Once you have stored a fax or phone number, you can use it to send a fax or make a phone call.

**1** If you are sending a fax, load the document(s).

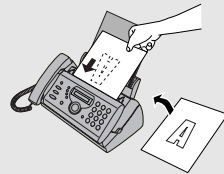
- If desired, press **RESOLUTION**  to set the resolution and/or contrast.



↓  
**READY TO SEND**

**2** Press  (or ) until the name of the other party appears in the display (if no name was stored, the number will appear).

**3** If you are sending a fax, press **START/MEMORY**  . Dialling and transmission begins.

- If the transmission is completed successfully, the fax will beep once.
- If an error occurs, the fax will beep three times and print a Transaction Report to inform you of the problem (see page 116).

**If you are making a phone call, lift the handset. Dialling begins.**

## ***Sending a fax by Direct Keypad Dialling***

You can also enter a full number with the number keys and then press the **START/MEMORY**  key to begin dialling. You can use this method to dial a full number when you don't need to speak to the other party before faxing.

### **1 Load the document(s).**

- If desired, press **RESOLUTION**  to set the resolution and/or contrast.

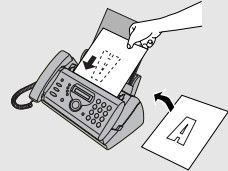

**READY TO SEND**

### **2 Enter the number of the receiving machine by pressing the number keys.**

- If a pause is required between any of the digits to access a special service or an outside line, press **FUNCTION** . The pause will appear as a hyphen. Several pauses can be entered in a row.

### **3 Check the display. If the number of the receiving machine shown is correct, press **START/MEMORY** .**

- If the number is not correct, press **STOP**  to backspace and clear one digit at a time, and then re-enter the correct digit(s).

## Redial

You can automatically redial the last number dialled. This procedure can be used to send a fax or make a phone call.

**1** If you are sending a fax, load the document(s).

- If desired, press **RESOLUTION** to set the resolution and/or contrast.

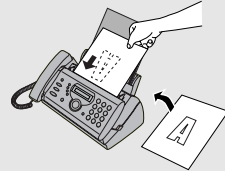

READY TO SEND

**2** Press **◀** once. <REDIAL> appears in the display, followed by the last number dialled. Make sure the number that appears is the number you wish to dial.

**3** If you are sending a fax, press **START/MEMORY**. Dialling and transmission begins.

If you are making a phone call, lift the handset. Dialling begins.

**Note:**

If a fax transmission is unsuccessful and DOCUMENT JAMMED appears in the display, remove the document as explained on page 134. (This may occur if the other fax machine doesn't respond properly when you attempt to send the document.)

## Automatic redialling



If you use automatic dialling (including Direct Keypad Dialling) to send a fax and the line is busy, the fax machine will automatically redial the number. The fax machine will make two redial attempts at an interval of five minutes. During this time, RECALLING will appear in the display, followed by a two-digit number assigned to the fax job. You will not be able to dial any other locations while the message appears.

- ◆ To stop automatic redialling, press .
- ◆ Under certain conditions (for example if a person answers the call on a telephone), automatic redialling may stop before two redialling attempts are made.



## Error Correction Mode

The fax machine is set to automatically correct any distortions in a transmission due to noise on the telephone line before printing at the receiving end. This function is called Error Correction Mode (ECM). ECM is effective for both transmissions and receptions, and is only effective when the other fax machine has ECM as well.

When there is considerable noise on the line, you may find that transmission with ECM turned on takes longer than normal. If you prefer a faster transmission time, you can try turning ECM off.

**1** Press  once and  twice.

OPTION SETTING 

**2** Press  once and  4 times.

ECM MODE 

**3** Press  once.

1=YES, 2=NO

**4** Press  to select YES, or  to select NO.

The display briefly shows your selection, then:

RECEIVE RATIO 

**5** Press  to return to the date and time display.

## ***Sending a Fax From Memory***

You can scan a document into the fax's memory and send the document from memory. This increases transmission speed and allows you to send a fax to multiple destinations in a single operation. After transmission, the document is automatically cleared from memory.

### ***Broadcasting (sending a fax to multiple destinations)***

This function allows you to send the same fax to as many as 20 different locations in just one operation.

- ◆ When sending to multiple locations, only auto-dial numbers can be used to dial the numbers of the receiving machines.

#### **1 Load the document(s).**

- If desired, press **RESOLUTION**  to set the resolution and/or contrast.

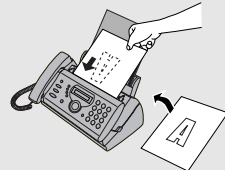



#### **2 Press **START/MEMORY** .**

#### **3 Press (or ) until the name of the number appears in the display (if no name was stored, the number will appear).**

#### **4 Press to select the number.**

#### **5 Repeat Steps 3 and 4 for each of the other locations to which you wish to send the fax (maximum of 20).**

- To check your selected locations, press  to scroll through them. To delete a location, scroll to the location and then press **STOP** .









## 6 When you are ready to begin transmission, press .

- A Transaction Report is automatically printed out after Broadcasting is completed. Check the "Note" column of the report to see if any of the locations are marked "Busy" or have a communication error code. If so, send the document to those locations again.

### Memory transmission



You can also send a fax through memory when sending to a single location. This is convenient when sending to locations where the line is often busy, as it saves you from waiting to pick up the original document and frees the feeder for other operations.

To send a fax through memory, load the document, press , and then dial using one of the following methods:

- ◆ Press the number keys to enter the fax number and then press .
- ◆ Press  repeatedly to select an auto-dial number and press .
- ◆ Press  once to select the last number dialled and press .

### If the memory becomes full...

If the memory becomes full while the document is being scanned, MEMORY IS FULL and SEE MANUAL will alternately appear in the display.

- ◆ Press  if you want to transmit the pages which have been stored up to that point in memory. The remaining pages will be ejected from the feeder. After transmission, the memory will be cleared and you can transmit the remaining pages. You will also need to transmit the page which was being scanned when the memory filled up.
- ◆ Press  if you want to cancel the entire transmission.

---

## 5. Receiving Faxes

### Using TEL/FAX Mode

To select TEL/FAX mode, press **RECEPTION MODE** until the arrow in the display points to TEL/FAX.

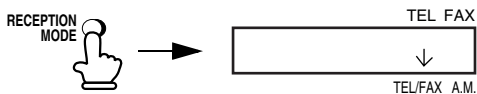













When the reception mode is set to TEL/FAX, your fax machine automatically answers all calls on two rings. After answering, your fax monitors the line for about five seconds to see if a fax tone is being sent.

- ◆ If your fax machine detects a fax tone (this means that the call is an automatically dialed fax), it will automatically begin reception of the incoming document.
- ◆ If your fax machine doesn't detect a fax tone (this means that the call is a voice call or manually dialed fax), it will make a ringing sound (called pseudo ringing) for 15 seconds to alert you to answer. If you don't answer within this time, your fax will send a fax tone to the other machine to allow the calling party to send a fax manually if they desire.

**Note:** Only the fax will alert you to voice calls or manually dialed faxes by pseudo ringing. An extension phone connected to the same line will not ring after the connection has been established.

## Pseudo Ring Duration for Tel/Fax Mode

If desired, you can change the duration of pseudo ringing in Tel/Fax mode.

<b>1</b> Press  once and  twice.	Display: OPTION SETTING 
<b>2</b> Press  once and  3 times.	PSEUDO RING 
<b>3</b> Press  once.	1=15 SECONDS (Selections appear alternately)
<b>4</b> Enter a number as follows for the desired duration:	
<ul style="list-style-type: none"> <li> 15 SECONDS</li> <li> 30 SECONDS</li> <li> 60 SECONDS</li> <li> 120 SECONDS</li> </ul>	
The display briefly shows your selection, then:	DISTINCTIVE 
<b>5</b> Press  to return to the date and time display.	

## Using A.M. Mode

To select A.M. mode, press  until the arrow in the display points to A.M.

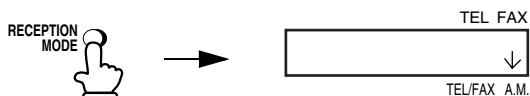

In A.M. mode, your fax machine will automatically receive voice messages and faxes. See Chapter 3 for more details.

## Using FAX Mode

To select FAX mode, press **RECEPTION MODE** until the arrow in the display points to FAX.

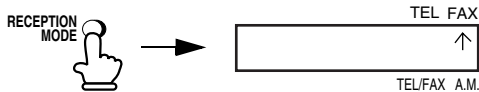

When the reception mode is set to FAX, the fax machine will automatically answer all calls on two rings and receive incoming faxes.

- ◆ If you pick up the handset before the machine answers, you can talk to the other party and/or receive a fax as explained in *Using TEL Mode* on page 99.

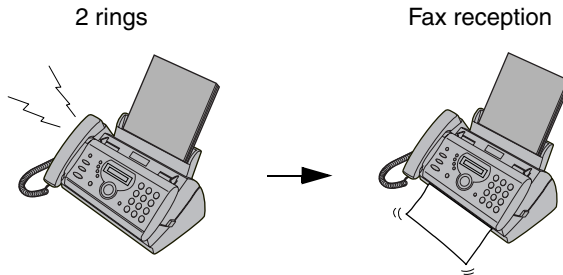

## Changing the number of rings

If desired, you can change the number of rings on which the fax machine answers incoming calls in FAX and TEL/FAX mode. Any number from 2 to 4 can be selected.

**1** Press **FUNCTION** once and **▲** twice.

Display:

OPTION SETTING ◀▶

**2** Press **▶** once.

NUMBER OF RING ◀▶

**3** Press  once.

ENTER (2-4) (2)

**4** Enter the desired number of rings (any number from 2 to 4).

The display briefly shows your selection, then:

Example: 3 rings 

TRANSACTION 

**5** Press  to return to the date and time display.

## Using TEL Mode

To select TEL mode, press  until the arrow in the display points to TEL.

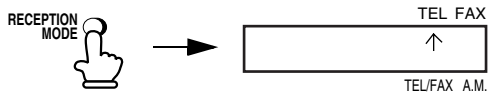

When the reception mode is set to TEL, you must answer all calls by picking up the fax machine's handset or an extension phone connected to the same line.

## Answering with the fax's handset

- 1** When the fax machine rings, pick up the handset.

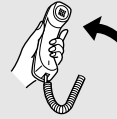

- 2** If you hear a fax tone, wait until the display shows RECEIVING and then replace the handset.



RECEIVING

**Note:** If you have set the Fax Signal Receive setting (page 102) to NO, press **START/MEMORY**  to begin reception.

- 3** If the other party first speaks with you and then wants to send a fax, press **START/MEMORY**  after speaking. (Press **START/MEMORY**  before the sender presses their Start key.)

START/MEMORY 

RECEIVING

- When RECEIVING appears in the display, hang up.



## Answering on an extension phone

You can also start fax reception in TEL mode by answering any extension phone connected to the same line as the fax machine.

- ◆ To start fax reception from the cordless handset, see page 38.

- 1 Answer the extension phone when it rings.**

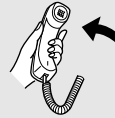

- 2 If you hear a soft fax tone, wait until your fax responds (the extension phone will go dead), then hang up.**



Phone goes dead



- If you have set the Fax Signal Receive setting to NO (see page 102), or if the fax machine does not respond, set the extension phone down (do not hang up), walk over to the fax machine, pick up the handset, and press

**START/MEMORY**



## Putting a call on hold

To put the other party on hold during a phone conversation, press **▶PLAY/HOLD** .



When this is done, they cannot hear you. You can put the handset back in the cradle without breaking the connection. When you are ready to speak with the other party again, pick up the handset. If you did not put the handset back in

the cradle, press **▶PLAY/HOLD**  again to resume conversation.

## Optional Reception Settings

### Fax Signal Receive

Your fax will automatically begin reception if you hear a soft fax tone after answering a call on your fax or an extension phone. If you use a computer fax modem to send documents on the same line, you must turn this function off in order to prevent your fax from mistakenly attempting to receive documents from the computer fax modem. Follow the steps below to change the setting.

**1** Press  once and  twice.

Display:



OPTION SETTING 

**2** Press  once and  5 times.

FAX SIGNAL RX 

**3** Press  once.

1=YES, 2=NO

**4** Press  to turn on the function, or  
 to turn it off.

The display briefly shows your selection, then:

CALLER-ID 

**5** Press  to return to the date and time display.



## Reception Ratio

The fax has been set at the factory to automatically reduce the size of received documents to fit the size of the printing paper. This ensures that data on the edges of the document are not cut off. If desired, you can turn this function off and have received documents printed at full size.

- ◆ If a document is too long to fit on the printing paper, the remainder will be printed on a second page. In this case, the cut-off point may occur in the middle of a line.
- ◆ Automatic reduction may not be possible if the received document is too large, contains too many fine graphics or images, or is sent at high resolution. In this case, the remainder of the document will be printed on a second page.

**1** Press **FUNCTION** once and **▲** twice.

Display:

OPTION SETTING **↔**

**2** Press **▶** once and **▲** 3 times.

RECEIVE RATIO **↕**

**3** Press **▶** once.

1=AUTO, 2=100%

**4** Press **1** to select AUTO, or **2** to select 100%.

The display briefly shows your selection, then:

PRINT CONTRAST **↔**

**5** Press **STOP** to return to the date and time display.

## ***Substitute Reception to Memory***

In situations where printing is not possible, such as when your fax runs out of paper, the imaging film needs replacement, or the paper jams, incoming faxes will be received to memory.

When you have received a document in memory, FAX RX IN MEMORY will appear in the display, alternating with ADD PAPER & PRESS START KEY or CHECK FILM / CHECK COVER / CHECK PAPER JAM. When you add paper (and press **START/MEMORY** ) , replace the imaging film, or clear the jam, the stored documents will automatically print out.

- ◆ The machine will retain any received faxes in memory until printed, even if the power cord is unplugged or a power failure occurs.

## 6. Making Copies

Your fax machine can also be used to make copies. Single and multiple copies (up to 99 per original) can be made, enabling your fax to double as a convenience office copier.

### 1 Load the document(s) face down. (Maximum of 10 pages.)

- If desired, press **RESOLUTION** to set the resolution and/or contrast. (The default resolution setting for copying is FINE.)

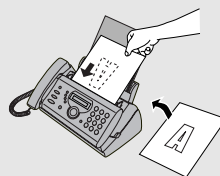

READY TO SEND

### 2 If desired, select an enlarge/reduce setting, and/or select the number of copies per original:

- ENLARGE/REDUCE: Press **▲** or **▼** until the desired setting appears in the display. Settings are 100%, 125%, 135%, 50%, 73%, 88%, 94%, and AUTO. (The default setting is 100%.)

Example: Press **▲** twice



RATIO: 125%

- Number of copies per original: Press the number keys to enter a number from 1 to 99. (The default setting is 1.)

Example: Press **5** for five copies



5



### 3 When you are ready to begin copying, press **COPY/HELP/POLL**.

#### If MEMORY IS FULL appears...

If the memory becomes full while a document is being scanned, MEMORY IS FULL and SEE MANUAL will alternately appear in the display and the document will automatically feed out. This may happen if the resolution is set to SUPER FINE, or if you selected an enlarge/reduce setting, or if you are making more than one copy per original. To avoid using memory, use STANDARD or FINE for the resolution, 100% for the enlarge/reduce setting, and make only one copy per original.



## Copy Cut-off

When making a copy of a document that is longer than the printing paper, use the copy cut-off setting to select whether the remaining part of the document will be cut off or printed on a second page. The initial setting is YES (cut off the remainder). To change the setting, follow the steps below.

**1** Press **FUNCTION**  once and  twice.

Display:



OPTION SETTING 

**2** Press  once and  once.

COPY CUT-OFF 

**3** Press  once.

1=YES, 2=NO

**4** Press  to set copy cut-off to YES (the remaining part of the document will not be printed), or  to set copy cut-off to NO (the remaining part will be printed on a second page).

The display briefly shows your selection, then:

NUMBER OF RING 

**5** Press  to return to the date and time display.

## 7. Special Functions

### Caller ID (Requires Subscription to Service)

If you subscribe to a caller identification service from your telephone company, you can have the fax machine and the cordless handset display the name and number of the caller when you receive a call.

**Important:**

- ◆ To use this function, you must subscribe to a caller identification service from your telephone company.
- ◆ Your fax may not be compatible with some caller identification services.

**1** Press **FUNCTION** once and **▲** twice.

Display:

OPTION SETTING 

**2** Press **▶** once and **▲** 5 times.

CALLER-ID 

**3** Press **▶** once.

1=YES, 2=NO

**4** Press **1** (YES) to turn on Caller ID.  
(To turn off Caller ID, press **2** .)

The display briefly shows your selection, then:

ECM MODE 

**5** Press **STOP** to return to the date and time display.

## ***How Caller ID operates***

When you receive a call, the name and phone number of the caller will alternately appear in the fax machine display and cordless handset display, beginning just before the second ring. The information will continue to be displayed until the line is disconnected.

Display example

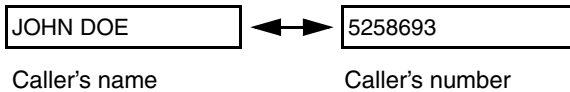

**Note:** Some caller ID services may not provide the name of the caller. In this case, only the phone number will appear.

## ***Display messages***

One of the following messages will appear while the fax rings if caller information is not available.

- |                 |  |
|-----------------|--|
| NO SERVICE      | No caller information was received from your telephone company. Make sure that the telephone company has activated your service.                                     |
| CALLER-ID ERROR | Noise on the telephone line prevented reception of caller information.   |
| UNAVAILABLE     | The call was made from an area which does not have a caller identification service, or the caller's service is not compatible with that of your local phone company. |
| PRIVATE         | Caller information was not provided by the telephone company at the caller's request.  |

## Viewing the Caller ID list



If you subscribe to a Caller ID service and have turned on the Caller ID function, your fax machine will keep information on the most recent 30 calls and faxes you have received. You can view this information, which consists of the name and number of each caller, in the Caller ID List.

- ◆ After you have received 30 calls, each new call will delete the oldest call.

Follow the steps below to view the Caller ID List in the display. If desired, you can immediately dial a number when it appears.

**1** Press  twice.

**<REVIEW CALLS>** 

**2** Press  or  to scroll through the list.



**3** If you want to dial one of the numbers in the list, scroll through the list until the number appears in the display.

- **Fax:** If you want to send a fax, load the document and then press . Dialling and transmission begin.

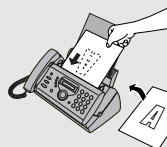
**Fax:**



**START/MEMORY** 

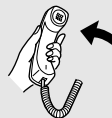

- **Voice call:** If you want to make a voice call, pick up the handset (or press ). Dialling begins automatically. (If you pressed , pick up the handset when the other party answers.)

**Voice call:**



**4** Press  when you have finished viewing the list.

## To delete calls from the Caller ID list

If you want to delete a single call from the caller list, press  while the call appears in the display. If you want to delete all calls from the list, hold  down for at least 3 seconds while you are viewing any number in the list.

## Viewing the Caller ID list from the cordless handset

You can also view the Caller ID list in the cordless handset display, and automatically dial a number from the list. See page 44.

## Priority Call

With Caller ID turned on, you can set your fax machine to make a special ringing sound when you receive a call from a designated phone number. This lets you know immediately who is calling without having to look at the display.



- ◆ This function is only for the fax machine. The cordless handset will not make a special ringing sound.

To use this function, enter the desired phone number by following the steps below (only one phone number can be entered).

**1** Press  once and  3 times. Display:

**2** Press  once and  once.

**3** Press  once.

**4** Press  to store a number.  
(To clear a previously stored number, press  and go to Step 6.)

**5** Enter the number by pressing the number keys (max. 20 digits).



---

**6** Press **START/MEMORY**  to store (or clear) the number.

---

**7** Press **STOP**  to return to the date and time display.

## ***Blocking voice calls***

With Caller ID turned on, you can use the Anti Junk Fax function described in *Blocking Reception of Unwanted Faxes* in this chapter to block voice calls as well as faxes from your specified Anti Junk Number.

In this case, when a voice call or a fax comes in from the number you have specified as a "Junk Number", your fax will terminate the call as soon as it receives the calling phone number from the caller ID service. The caller will hear a 3-second high-pitch tone to signal the call's termination. The call will not break off until the caller has hung up.

To use this function, enter the number that you wish to block as explained in *Blocking Reception of Unwanted Faxes* (see page 113). Only one number can be blocked.

## Distinctive Ring (Requires Subscription to Service)

If you subscribe to a distinctive ring service from your telephone company, you will need to turn on the distinctive ring function. When this is done, your fax will signal voice calls by the normal ring pattern, and fax transmissions by a special ring pattern. In the case of a fax transmission, your fax machine will automatically answer the call and receive the fax.

The distinctive ring function is used with the reception mode set to FAX. When your fax number is dialled, your fax machine will signal the call with a special ringing sound, then answer automatically and begin reception after the number of rings set with the Number of Rings setting (see page 98). When your voice number is dialled, the fax machine will signal the call with the normal ringing sound to let you know that you must answer personally.

The initial setting for distinctive ring is NO. If set to YES, Fax Duet distinctive ring is supported.

### Important:

- ◆ The distinctive ring function can only be used if you subscribe to a distinctive ring service from your telephone company. Do not turn on distinctive ring if you are on a normal line, as the fax machine will not operate properly.
- ◆ If you turn on distinctive ring, the fax will not operate in TEL/FAX reception mode.

**1** Press **FUNCTION** once and **▲** twice.

Display:

OPTION SETTING 

**2** Press **▶** once and **▼** 4 times.

DISTINCTIVE 

**3** Press **▶** once.

1=YES, 2=NO

**4** Press **①** to turn on the function, or **②** to turn it off.

The display briefly shows your selection, then:

FAX SIGNAL RX 



**5** Press  to return to the date and time display.

**6** Set the reception mode to FAX.





## Blocking Reception of Unwanted Faxes

The Anti Junk Fax function allows you to block reception of faxes from a party that you specify. This saves paper by not printing out unwanted "junk" faxes. To use this function, follow the steps below to enter the fax number from which you do not wish to receive faxes. One fax number can be entered.

**1** Press  once and  3 times.

Display:



ENTRY MODE 

**2** Press  once and  twice.

ANTI JUNK # 

**3** Press  once.

1=SET, 2=CLEAR

**4** Press  to store an Anti Junk number, or  to clear a previously stored number (if you are clearing a number, go to Step 6).

**5** Enter the fax number by pressing the number keys (max. 20 digits).

**6** Press 



**7** press  to return to the date and time display.

## ***Polling (Requesting a Fax Transmission)***

Polling allows you to call another fax machine and have it send a document to your machine without operator assistance. In other words, the receiving fax machine, not the transmitting fax machine, initiates the transmission.

---

### **1 Dial the fax machine you want to poll using one of the following methods:**

- Enter the full number using the numeric keys.
- Pick up the handset (or press  ) and dial the full number. Wait for the fax answerback tone.
- If the number has been stored for automatic dialling, press  or  until the name (or number) of the other party appears in the display.









---

### **2 Press .**

- If you used the handset, replace it when POLLING appears in the display. Reception will begin.

## 8. Printing Lists

You can print lists showing settings and information entered in the fax machine. The lists are described below. To print a list, follow these steps.

<p><b>1</b> Press  <b>once</b> and  <b>twice.</b></p>	<p>Display:  <div style="border: 1px solid black; padding: 2px; display: inline-block;">LISTING MODE </div></p>
<p><b>2</b> Press  <b>once.</b></p>	<p><div style="border: 1px solid black; padding: 2px; display: inline-block;">TEL # LIST </div></p>
<p><b>3</b> Press  <b>or</b>  <b>until the desired list appears in the display.</b></p>	
<p><b>4</b> Press  <b>once.</b></p>	<p><div style="border: 1px solid black; padding: 2px; display: inline-block;">PRESS START KEY</div></p>
<p><b>5</b> Press  <b>to print the list.</b></p>	

### Telephone Number List

This list shows the fax and phone numbers that have been stored for automatic dialling.

### Setup List

This list shows your current selections for the **FUNCTION** key settings. The list also shows your name and fax/telephone number as entered in the machine, and a sample of the header printed at the top of every page you transmit (**HEADER PRINT**).

### Message List

This list shows information about the messages currently recorded in the answering system, including the date and time each messages was recorded, the length, and the type.

### Caller-ID List

This list shows information about your 30 most recent calls. (This list is only available if you are using the Caller ID function.)

## ***Transaction Report***

This report is printed out automatically after an operation is completed to allow you to check the result. Your fax machine is set at the factory to print out the report only when an error occurs.

- ◆ The Transaction report cannot be printed on demand.

### **Headings in Transaction Report**

**SENDER/  
RECEIVER** The name or fax number of the other machine involved in the transaction. If that machine does not have an ID function, the communication mode will appear (for example, "G3").

**START** The time at which transmission/reception started.

**TX/RX TIME** Total time taken for transmission/reception.

**PAGES** Number of pages transmitted/received.

**NOTE** (One of the following notes will appear under **NOTE** in the report to indicate whether the transaction was successful, and if not, the reason for the failure.)

**OK** - Transmission/reception was successful.

**P.FAIL** - A power failure prevented the transaction.

**JAM** - The printing paper or document jammed, preventing the transaction.

**BUSY** - The fax was not sent because the line was busy.

**COM.E-X** - (Where "X" is a number.) A telephone line error prevented the transaction. See *Line error* on page 123.

**CANCEL** - The transaction was cancelled because the **STOP** key was pressed, no document was in the feeder, or the other machine requested transmission using a function which your fax machine does not have. If you were attempting to fax, make sure a document is in the feeder. If you were receiving, contact the faxing party to see how they are trying to send to you.

## Transaction Report print condition

You can change the condition under which a Transaction Report is printed out. Follow the steps below.

**1** Press **FUNCTION** once and **▲** twice.

Display:

OPTION SETTING 

**2** Press **▶** once and **▼** once.

TRANSACTION 

**3** Press **▶** once.

1:ALWAYS PRINT

(Selections appear alternately)

**4** Press a number from **①** to **⑤** to select the condition for printing.

- |          |              |  |
|----------|--------------|--|
| <b>①</b> | ALWAYS PRINT | A report will be printed after each transmission, reception, or error. |
| <b>②</b> | ERROR/MEMORY | A report will be printed after an error or a memory operation.         |
| <b>③</b> | SEND ONLY    | A report will be printed after each transmission.                      |
| <b>④</b> | ERROR ONLY   | A report will be printed only when an error occurs.                    |
| <b>⑤</b> | NEVER PRINT  | A report will never be printed.  |

The display briefly shows your selection, then:

DIAL MODE 

**5** Press **STOP** to return to the date and time display.

## Help List

This list provides a brief guide to the operation of the machine. Press **COPY/HELP/POLL** while no document is loaded in the feeder to print the list.



# 9. Maintenance

## Print head

Clean the print head frequently to ensure optimum printing performance.

**Note:** Remove the paper from the paper tray before cleaning the print head.

- 1** Unplug the telephone line and then the power cord, and open the operation panel (press **1**).

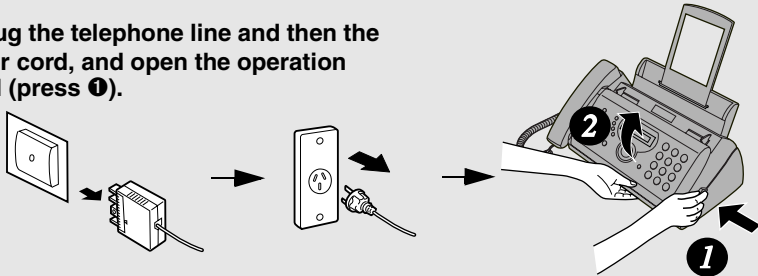

- 2** Take the imaging film out of the print compartment and place it on a sheet of paper.

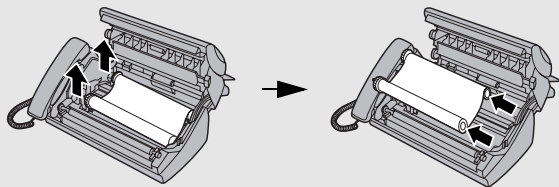

- 3** Wipe the print head with isopropyl alcohol or denatured alcohol.

### Caution!

- Do not use benzene or thinner. Avoid touching the print head with hard objects.
- The print head may be hot if your fax machine has just received a large number of documents. If this is the case, allow the print head to cool prior to cleaning.

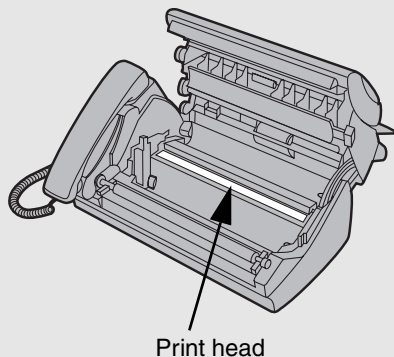



- 4** Place the imaging film back in the print compartment.

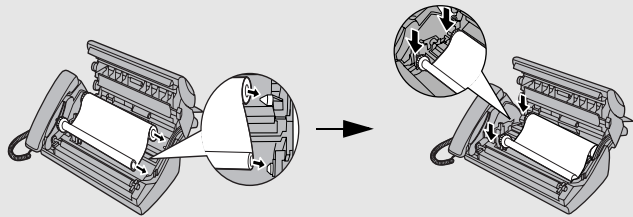

- 5** Rotate the front gear until the film is taut, and then close the operation panel (press down on both sides to make sure it clicks into place).

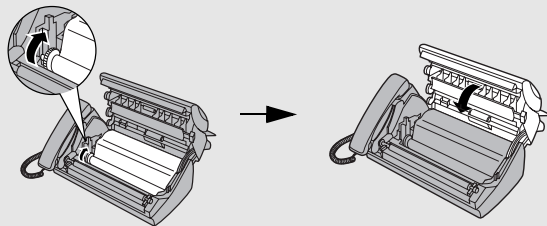

## Scanning glass and rollers

Clean the scanning glass and rollers frequently to ensure the quality of transmitted images and copies.

**Note:** Remove the paper from the paper tray before cleaning the scanning glass and rollers.

- 1** Open the operation panel (press **1**).

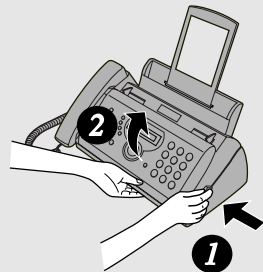

- 2** Flip up the green levers on each side of the white roller.

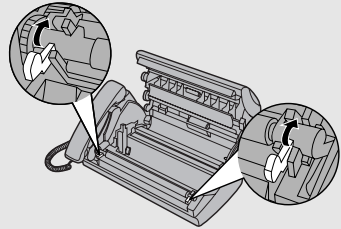

- 3** Wipe the scanning glass (under the white roller) and rollers with a cotton swab.

- Make sure that all dirt and stains (such as correcting fluid) are removed. Dirt and stains will cause vertical lines on transmitted images and copies.

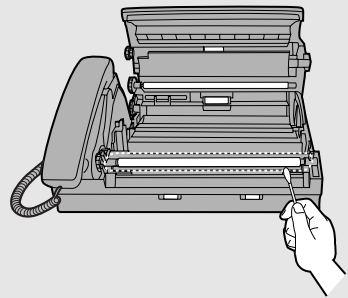

**If the scanning glass is difficult to clean**

If you find it difficult to remove dirt from the scanning glass, you can try moistening the swab with isopropyl alcohol or denatured alcohol. Take care that no alcohol gets on the rollers.

- 4** Flip down the green levers on each side of the white roller. Rotate the front gear until the film is taut, and then close the operation panel (press down on both sides to make sure it clicks into place).

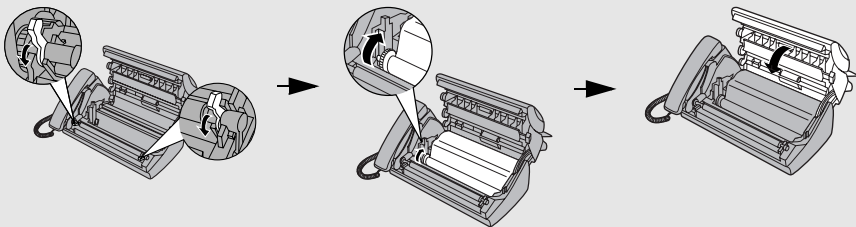



## The housing

Wipe the external parts and surface of the machine with a dry cloth.

**Caution!** Do not use benzene or thinner. These solvents may damage or discolor the machine.

## Replacing the Cordless Handset Batteries

Like any other battery, the rechargeable batteries will eventually wear out. The batteries can normally be used for about two years, although this will vary depending on the conditions of use.

If you find that  or  appears in the cordless handset display soon after the batteries are charged, replace them with the following batteries:

**Replacement batteries:** Use only 1.2 V Ni-MH batteries with a capacity of 630 mAh (min. of 600 mAh; type AAA).

**Caution:**

Danger of explosion if batteries are incorrectly replaced. Replace only with the same or equivalent type recommended by the manufacturer.

Dispose of used batteries according to the manufacturer's instructions.

- 1 Remove the battery cover by pressing on the indentation as shown.**

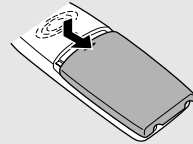

- 2 Remove the old batteries.**

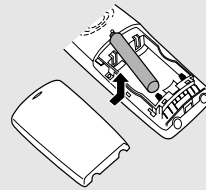

- 3 Insert the new batteries.**

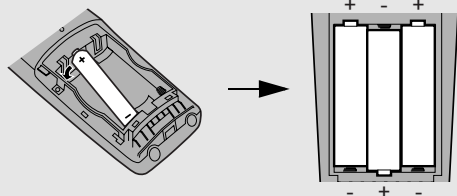

- 4** Place the battery cover on the cordless handset, making sure it snaps firmly into place.

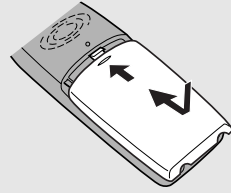

- 5** Place the cordless handset in the charger with the dial pad facing forward.

- Let the new batteries charge for at least **12** hours.

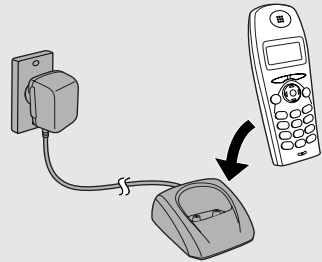

## ***Battery disposal***

The batteries are Nickel Metal Hydride batteries. The batteries must be disposed of properly. Contact local agencies for information on recycling and disposal plans in your area.

## ***Wiping the charger contacts***

To ensure that the battery charges properly, wipe the charger contacts once a month with a cotton swab.

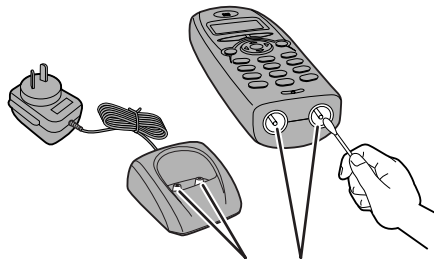

Charger contacts

---

# 10. Troubleshooting

## Problems and Solutions

### Line error

Problem	Solution
LINE ERROR appears in the display.	<p data-bbox="418 443 972 496">Try the transaction again. If the error persists, check the following:</p> <ul data-bbox="418 528 981 1007" style="list-style-type: none"><li data-bbox="418 528 981 608">• Check the connection. The cord from the <b>TEL. LINE</b> socket to the wall socket should be no longer than two meters.</li><li data-bbox="418 639 981 692">• Make sure there are no modem devices sharing the same telephone line.</li><li data-bbox="418 724 981 777">• Check with the other party to make sure their fax machine is functioning properly.</li><li data-bbox="418 809 981 836">• Have your telephone line checked for line noise.</li><li data-bbox="418 868 981 920">• Try connecting the fax machine to a different telephone line.</li><li data-bbox="418 952 981 1007">• If the problem still occurs, your fax machine may need service.</li></ul>

## ***Dialling and transmission problems***

<b>Problem</b>	<b>Solution</b>
<p>No dial tone when you pick up the handset or press the  key.</p>	<ul style="list-style-type: none"> <li>• Make sure the handset cord is connected to the correct socket. See <i>Connecting the handset</i> on page 17.</li> </ul>
<p>Dialling is not possible.</p>	<ul style="list-style-type: none"> <li>• Make sure the power cord is properly plugged into a power outlet.</li> <li>• Make sure that the telephone line is properly connected to both the <b>TEL. LINE</b> socket and the wall socket.</li> </ul>
<p>The power is on, but no transmission takes place.</p>	<ul style="list-style-type: none"> <li>• Make sure that the receiving machine has paper.</li> <li>• Make sure that the telephone line cord is plugged into the <b>TEL. LINE</b> socket, and not the <b>TEL. SET</b> socket.</li> <li>• If the receiving machine is in manual mode with no attendant, reception will not be possible.</li> <li>• Check the display for error messages.</li> <li>• Pick up the handset and check for a dial tone.</li> </ul>
<p>Nothing is printed at the receiving end.</p>	<ul style="list-style-type: none"> <li>• Make sure that the document for transmission is placed face down in the feeder.</li> </ul>
<p>A distorted image is received at the other end.</p>	<ul style="list-style-type: none"> <li>• Noise on the telephone line may cause distortion. Try sending the document again.</li> <li>• Make a copy of the document on your fax machine. If the copy is also distorted, your fax machine may need service.</li> </ul>

## Reception and copying problems

Problem	Solution
The power is on, but no reception takes place.	<ul style="list-style-type: none"> <li>• Make sure that the telephone line cord is plugged into the <b>TEL. LINE</b> socket, and not the <b>TEL. SET</b> socket.</li> </ul>
The printing paper comes out blank when you try to receive a document.	<ul style="list-style-type: none"> <li>• Make sure that the document is loaded properly in the feeder of the transmitting machine. Make a copy or print a report to confirm the printing ability of your machine.</li> </ul>
General print quality is poor.	<ul style="list-style-type: none"> <li>• It is important to select a paper that is appropriate for the thermal transfer printer in your fax. We recommend using laser quality paper that has a very smooth finish. Copier paper will work, but it sometimes tends to yield a lighter print quality.</li> </ul>
The received document is faint.	<ul style="list-style-type: none"> <li>• Ask the other party to send higher contrast documents. If the contrast is still too low, your fax machine may need service. Make a copy or print a report to check your machine's printing ability.</li> </ul>
Received images are distorted.	<ul style="list-style-type: none"> <li>• Noise on the telephone line may cause distortion. Have the other party try sending the document again.</li> <li>• The print head may be dirty. See <i>Print head</i> on page 118.</li> <li>• Make a copy or print a report on your fax machine. If the copy or report is also distorted, your fax machine may need service.</li> </ul>
A received document or copy prints out in strips.	<ul style="list-style-type: none"> <li>• Make sure the operation panel is completely closed (press down on both sides of the panel).</li> </ul>
The quality of copies is poor and/or dark vertical lines appear.	<ul style="list-style-type: none"> <li>• Any dirt or material on the scanning glass will cause spots to appear on copies and transmitted faxes. Clean the scanning glass as explained on page 119.</li> </ul>

<p>Reception/copying is interrupted.</p>	<ul style="list-style-type: none"> <li>• If reception or copying takes place continuously for a long time, the print head may overheat. Turn off the power and let it cool down. If overheating frequently occurs, try changing the print contrast setting to LIGHT (see page 27).</li> </ul>
<p>Dark vertical lines appear on copies and received faxes.</p>	<ul style="list-style-type: none"> <li>• Try changing the print contrast setting to LIGHT (see page 27).</li> </ul>

### General problems

<p><b>Problem</b></p>	<p><b>Solution</b></p>
<p>A loud howling sound occurs when the speaker is used.</p>	<ul style="list-style-type: none"> <li>• Feedback (a loud howling sound) may occur if you replace the handset while the speaker is on. To avoid feedback, turn off the speaker (press  ) before you replace the handset.</li> </ul>
<p>Auto-dial numbers cannot be stored in the fax.</p>	<ul style="list-style-type: none"> <li>• Make sure the fax is plugged in and the imaging film has been loaded. (Auto-dial numbers cannot be stored if the imaging film has not been loaded.) See <i>Loading the Imaging Film</i> on page 24.</li> </ul>
<p>Nothing appears in the display.</p>	<ul style="list-style-type: none"> <li>• Make sure the power cord is properly plugged into a power outlet.</li> <li>• Connect another electrical appliance to the outlet to see if it has power.</li> </ul>
<p>The machine does not respond when you press any of its keys.</p>	<ul style="list-style-type: none"> <li>• If a beep sound is not made when you press the keys, unplug the power cord and then plug it in again several seconds later.</li> </ul>
<p>Automatic document feeding does not work for transmission or copying.</p>	<ul style="list-style-type: none"> <li>• Check the size and weight of the document (see <i>Transmittable Documents</i> on page 81).</li> </ul>



***Cordless handset problems***

<b>Problem</b>	<b>Solution</b>
The cordless handset does not operate and nothing appears in the display.	<ul style="list-style-type: none"> <li>• Make sure the batteries are correctly inserted in the cordless handset (see page 21).</li> <li>• The batteries may be low. Place the cordless handset in the charger and let it charge.</li> </ul>
Calls cannot be made or received on the cordless handset.	<ul style="list-style-type: none"> <li>• Make sure the fax machine is plugged into a power outlet and has power.</li> <li>• Make sure the telephone line is properly connected to both the <b>TEL. LINE</b> socket on the fax machine and the wall jack (see page 18). (If the telephone line is connected correctly, you should hear a dial tone when you pick up the fax machine handset.)</li> <li>• The batteries may be low. Place the cordless handset in the charger and let it charge.</li> <li>• Calls cannot be made or received while the fax machine is being used (while <b>BUSY</b> appears in the cordless handset display). Wait until the fax machine is no longer being used.</li> <li>• Calls cannot be made or received during a power failure.</li> <li>• You may be outside of the talking range. Move closer to the fax machine.</li> </ul>
You hear noise or interference during a call.	<ul style="list-style-type: none"> <li>• Other electrical appliances may cause interference. Move away from any electrical appliances.</li> <li>• Move closer to the fax machine. Note that large metal objects, metal structures, and thick walls between the fax machine and cordless handset will reduce the talking range. If needed, try moving the fax machine to a different location.</li> </ul>

## Problems and Solutions

<p>The batteries do not charge.</p>	<ul style="list-style-type: none"><li>• Make sure the cordless handset is placed in the charger with the dial pad facing forward.</li><li>• Make sure the AC adapter is connected correctly to the charger and the power outlet (see page 20).</li><li>• Wipe the charger contacts with a cotton swab.</li><li>• Make sure the batteries are correctly inserted in the cordless handset (see page 21).</li><li>• The batteries may need replacement (see page 121).</li></ul>
<p>You hear beeps during a call.</p>	<ul style="list-style-type: none"><li>• You will hear beeps during a call and  will blink in the display if the batteries are low. Place the cordless handset in the charger and let it recharge. If you hear beeps during a call and need to continue the call, transfer the call to the fax machine (see page 47).</li></ul>

## Messages and Signals

### Display messages (fax machine)

**Note:** If you have turned on the Caller ID function, see page 108 for display messages related to Caller ID.





ADD PAPER & / PRESS START KEY (alternating messages)	Check the printing paper. If the tray is empty, add paper and then press the <b>START/MEMORY</b> key. If there is paper in the tray, make sure it is inserted correctly (take out the stack, align the edges evenly, and then reinsert it in the tray) and then press the <b>START/MEMORY</b> key.
A.M. TRANSFER	The answering system's transfer function has been turned on (see page 70).
CALL TRANSFER	A call is being transferred. (On occasion, this may also appear while paging the cordless handset for an intercom call.)
CHECK FILM/ CHECK COVER/ CHECK PAPER JAM (alternating messages)	These alternating messages appear when there is a problem in the print compartment that prevents printing. Check to see if the imaging film is not loaded properly or if it has been used up and needs replacement. Make sure the operation panel is completely closed (press down on both sides). If a paper jam has occurred, clear the jam as explained in the following section, <i>Clearing Paper Jams</i> .
CHECK PAPER SIZE	An incorrect size of paper has been loaded in the paper tray. Remove the paper and load A4-size paper.
DECT HS IN USE	The cordless handset is in use. Wait until this message no longer appears to send a fax or make a phone call from the fax machine.
DOCUMENT JAMMED	The original document is jammed. See the following section, <i>Clearing Paper Jams</i> . Document jams will occur if you load more than 10 pages at once or load documents that are too thick (see page 81).

FAX RX IN MEMORY	A fax has been received in memory because the imaging film needs replacement, you have run out of printing paper, or the paper is jammed. The fax will print out automatically when the problem is fixed.
FUNCTION MODE	The <b>FUNCTION</b> key has been pressed.
HOLD	The <b>HOLD</b> key has been pressed to place a call on hold. Press the <b>HOLD</b> key again to resume the call.
INCORRECT FILM/ CHECK FILM	The wrong type of imaging film is loaded in the machine. Printing is not possible. The machine can only print when SHARP FO-9CR imaging film is loaded.
INTERCOM	A cordless handset is paging the fax machine (lift the handset to talk), or the fax machine is paging a cordless handset. The name and number of the cordless handset appear alternately with INTERCOM.
LINE ERROR	Transmission or reception was not successful. Press the <b>STOP</b> key to clear the message and then try again. If the error persists, see <i>Line Error</i> on page 123.
MEMORY IS FULL/ SEE MANUAL (alternating messages)	The memory is full. You may have too many messages recorded in the answering system. To erase messages, see page 67. This message may also occur during fax reception if too much data is received before the pages can be printed out. If faxes have been received to memory because printing is not possible (an additional message will indicate the problem), resolve the problem so that printing can continue (see <i>Substitute Reception to Memory</i> on page 104). If you are attempting to transmit from memory, see <i>If the memory becomes full</i> on page 95. If you are copying, see <i>If MEMORY IS FULL appears</i> on page 105.
MEMORY PRINTING	The fax is preparing to or printing out a document from memory.

NEAR END OF FILM/ REPLACE FILM	This message appears 3 m from the end of the imaging film (approximately 10 pages can still be printed), and alerts you that you will soon need to replace the film.
NO DATA	This appears if you attempt to search for an auto-dial number when none have been stored.
NOT REGISTERED	You attempted to delete, page, or transfer a call to a cordless handset that is not registered.
OFF HOOK	This appears if you forgot to replace the handset after using it to dial and send a fax. Replace the handset or press the <b>STOP</b> key to clear the message.
ON HOOK DIAL	The  key has been pressed and the fax machine is waiting for you to dial.
OVER HEAT	The print head has overheated. Operation can be continued after it cools. If overheating frequently occurs, try changing the print contrast setting to LIGHT (see page 27).
PRINT HEAD FAIL/ YOU NEED SERVICE (alternating messages)	The print head has failed and requires service.
READY TO SEND	A document has been loaded and the fax machine is waiting for you to begin faxing or copying.
RECALLING	This appears if you attempt to send a fax by automatic dialling and the line is busy or the receiving fax machine does not answer. Your fax machine will automatically reattempt the call. (See <i>Automatic redialling</i> on page 92.)
REPLACE HANDSET	This appears if an outside call comes in while you are paging or talking to the cordless handset using the Intercom feature. Replace the fax machine handset to stop the Intercom call, and then pick it up again to answer the outside call. This also appears after you transfer a call to the cordless handset.

MESSAGES RCVD:XX	This indicates that you have received messages in the answering system. "XX" is the number of messages.
TOTAL PAGE(S) 01	Number of pages transmitted, received, or copied.

**Display messages (cordless handset)**

BUSY	When you attempt to make a phone call or page another device (fax machine or cordless phone), the system or other device is busy and cannot respond. Wait until the system or device is no longer busy. This message may also appear if you are slightly out of the communication range and you attempt to make a phone call (try moving closer to the fax machine; note that the display may still indicate that you are in range).
C (blinking)	 has been pressed to place a call on hold. To resume the call, press  again.
CALLS	This appears when you access the Caller ID list in the fax machine by holding down  (only if you have Caller ID).
EMPTY	This appears if you access the fax machine's phone book or Caller ID list and there are no numbers.
0 - 6 (a number from 0 to 6 appears)	Your cordless handset is being paged (press  to answer), or your cordless handset is paging the fax machine or another cordless handset.
 (blinking)	The cordless handset batteries are low and need recharging. Place the cordless handset in the charger. If this appears soon after the batteries have been charged, the batteries may need replacement (see page 121). If this appears during a phone call (you will also hear beeps) and you need to continue the call, transfer the call to the fax machine.

***Audible signals***

Continuous tone	3 seconds	Indicates the end of transmission, reception, or copying.
Intermittent tone (3 beeps)	5 seconds (1 second on, 1 second off)	Indicates incomplete transmission, reception, or copying.
Rapid intermittent tone	35 seconds (0.7 seconds on, 0.3 seconds off)	Indicates that the handset is off hook.

# Clearing Paper Jams

## Clearing a jammed document

If the original document doesn't feed properly during transmission or copying, or DOCUMENT JAMMED appears in the display, first try pressing

START/MEMORY



. If the document doesn't feed out, remove it as explained below.

### Important:

Do not try to remove a jammed document without releasing it as explained below. This may damage the feeder mechanism.

- 1** Press **1** and slowly open the operation panel until it is half open.

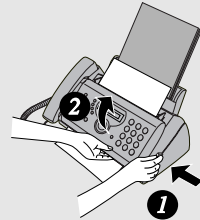

- 2** Flip up the green levers on each side of the white roller.

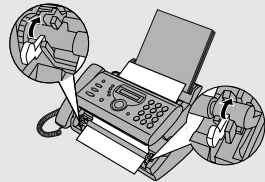

- 3** Gently remove the document.

- Be careful not to tear the document.

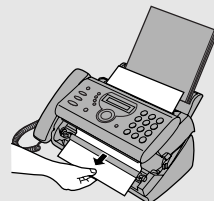



- 4** Flip down the green levers on each side of the white roller. Rotate the front gear until the film is taut, and then close the operation panel (press down on both sides to make sure it clicks into place).

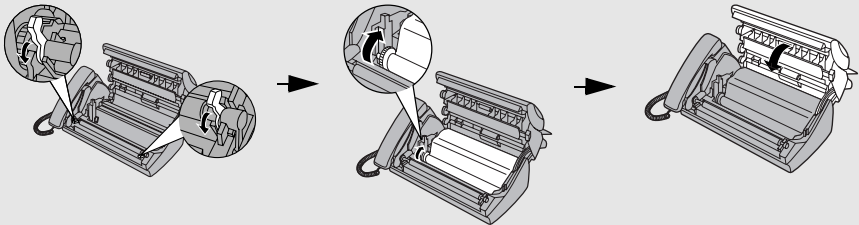

### Clearing jammed printing paper

- 1** Open the operation panel (press ❶).

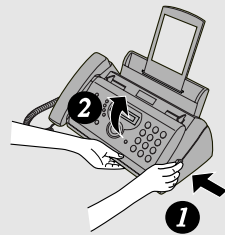

- 2** Gently pull the jammed paper out of the machine, making sure no torn pieces of paper remain in the print compartment or rollers.

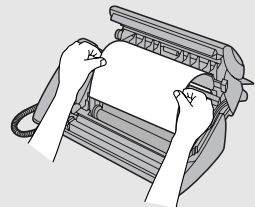

- 3** Rotate the front gear until the film is taut, and then close the operation panel (press down on both sides to make sure it clicks into place).

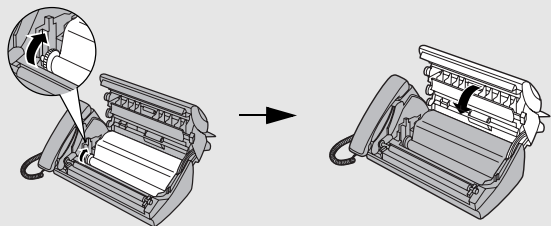

# Quick Reference Guide

## Sending Faxes

Place your document (up to 10 pages) face down in the document feeder.

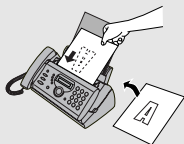

### Normal Dialling

1. Lift the handset or press .
2. Dial the fax number.
3. Wait for the reception tone (if a person answers, ask them to press their Start key).

4. Press **START/MEMORY** .

### Automatic Dialling

1. Press or until the desired destination appears in the display.

2. Press **START/MEMORY** .

### Direct Keypad Dialling

1. Dial the fax number.

2. Press **START/MEMORY** .

## Recording an Outgoing Message

1. Press **REC/MEMO** , , and .

2. Lift the handset, press **START/MEMORY** , and speak into the handset.

3. When finished, press **STOP** .

## Receiving Faxes

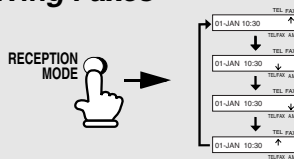

**FAX mode:** The fax machine automatically answers and receives faxes.

**TEL mode:** Answer all calls (even faxes) by picking up the handset. To begin fax

reception, press **START/MEMORY** .

**TEL/FAX mode:** The fax machine automatically answers and receives faxes. Voice calls are signalled by a special ringing sound.

**A.M. mode:** Select this mode when you go out to receive both voice messages and faxes.

## Storing Auto Dial Numbers

1. Press **FUNCTION** once and twice.

2. Enter the full fax/phone number.

3. Press **START/MEMORY** .

4. Enter a name by pressing number keys. (To enter two letters in succession that require the same key, press after entering the first letter.)

SPACE = 1	G = 4	N = 6 8	U = 8 8
A = 2	H = 4 4	O = 6 8 6	V = 8 8 8
B = 2 2	I = 4 4 4	P = 7	W = 9
C = 2 2 2	J = 5	Q = 7 7	X = 9 9
D = 3	K = 5 5	R = 7 7 7	Y = 9 9 9
E = 3 3	L = 5 5 5	S = 7 7 7 7	Z = 9 9 9 9
F = 3 3 3	M = 6	T = 8	

5. Press **START/MEMORY** and then **STOP** .

## Using the Cordless Phone

### Making a phone call

1. Pick up the cordless handset and press





2. When you hear the dial tone, dial the number.

3. When you are ready to end the call,



### Making a phone call using automatic dialling

1. Press  once.

2. Press  or  until the number you wish to dial appears in the display.

3. Press .

### Receiving a phone call



1. When the cordless handset rings, pick it up and press .











2. When you are ready to end the call, press .





### Receiving a fax using the cordless handset

If you hear a fax tone after answering a call on the cordless handset, or if the other party speaks to you and then wants to send a fax, press .









## Storing auto dial numbers

1. Press  and then press  twice.
2. Enter a name for the auto-dial number. To enter each letter, hold down the key for the letter as shown in the chart below until the letter appears in the display.

SPACE, PAUSE (—), - = 0	M, N, O = 	# (□), ?, _ = 
A, B, C = 	P, Q, R, S = 	
D, E, F = 	T, U, V = 	
G, H, I = 	W, X, Y, Z = 	
J, K, L = 	* = 	

3. Press .
4. Enter the full fax/phone number. To clear a mistake, press . To insert a pause, hold down  until “—” appears.
5. Press  and then  repeatedly to exit.

### Listening to messages

1. Press  and then press .
2. Press  to listen to all your messages, or  to listen to only your new messages.
3. While listening, you can do the following:
  - Repeat a message: Press .
  - Skip a message: Press .
  - Delete a message: Press  while the message is playing.
  - Stop playback: Press .
4. When finished, press  repeatedly to exit.

---

# Index

## A

- A.M. reception mode, 32, 64
- Anti Junk Fax, 113
- Audible signals, 133
- Auto-dial numbers
  - Storing, 38, 87
  - Using, 40, 90

## B

- Battery
  - Disposing of, 122
  - Installing, 21
  - Replacing, 121

## C

- Call time, 52
- Caller ID, 107-111
- Caller ID List, 115
- Contrast, 84
- Copies, 105
- Copy cut-off setting, 106
- Cordless handset
  - Auto-dial numbers, storing, 38
  - Auto-dial numbers, using, 40
  - Automatic registration, 55
  - Beeps, 52
  - Deleting, 62
  - Deleting calls, 45
  - Display language, 61
  - End call setting, 53
  - Faxes, receiving, 38
  - Hold, 37
  - Listening to messages, 54
  - Making a call, 36
  - Melody, 50
  - Power, 53
  - Quick Search, 41
  - Receiver volume, 36
  - Receiving a call, 37
  - Redial, 44

- Ringer volume, 50
- System PIN, 57
- Talking range, 23
- Turning off ringer, 51
- Viewing calls, 44

## D

- Date, setting, 30
- Dial mode, 18
- Dialling
  - Automatic, 40, 90
  - Direct Keypad, 91
  - Normal, 36, 85
- Direct Keypad Dialling, 91
- Display messages, 129
- Distinctive ring, 112
- Document feeder, 82
- Document guides, 82
- Document restrictions, 82
- Document sizes, 81
- Document, maximum scanning size, 81

## E

- ECM (Error Correction Mode), 93
- Extension telephone
  - Connecting, 20
  - Using, 101

## F

- Fax Duet (distinctive ring), 112
- Fax mode on TAD failure, 68
- FAX reception mode, 32, 98
- Fax Signal Receive, 102

## H

- Half-tone setting, 83
- Handset, 17
- Hold, 101
- Housing, cleaning, 120

**I**

Imaging film, replacing, 24  
Intercom, 45

**J**

Jams, clearing, 134-135

**L**

Letters, entering, 29, 39, 88  
Line error, 123  
Loading paper, 26  
Loading the document, 82

**M**

Memory transmission, 95  
Memory, substitute reception to, 104  
Message List, 115  
Messages  
    Erasing, 67  
    Listening to, 66  
    Listening to remotely, 75  
    Setting allowed time, 68

**N**

Normal Dialling, 36, 85  
Number of rings in A.M. mode, 65  
Number of rings in FAX reception mode,  
    98

**O**

OGM only mode, 69  
Outgoing message, 63

**P**

Paper jams, clearing, 134-135  
Paper tray extension, 19  
Paper, loading, 26  
Polling, 114

Power cord, 17  
Print contrast setting, 27  
Print head, cleaning, 118-119  
Priority Call, 110  
Pseudo Ring Duration, 97

**R**

Reception mode  
    A.M. mode, 32, 64  
    FAX mode, 32, 98  
    TEL mode, 32, 99  
    TEL/FAX mode, 32, 96  
Reception Ratio setting, 103  
Redialling, 92  
Remote code number, 74  
Remote operations, 74  
Resolution, 83  
Ringer volume  
    Fax machine, 34

**S**

Scanning glass, cleaning, 119  
Sender's name and number, entering,  
    28-29  
Setup List, 115  
Speaker volume, 33

**T**

TEL reception mode, 32, 99  
TEL. LINE socket, 18  
TEL. SET socket, 20  
TEL/FAX reception mode, 32, 96  
Telephone line cord, 18  
Telephone Number List, 115  
Time, setting, 30  
Toll Saver function, 65, 74  
Transaction Report, 116  
    Setting print condition, 117  
Transfer Function, 70  
Transferring calls, 47

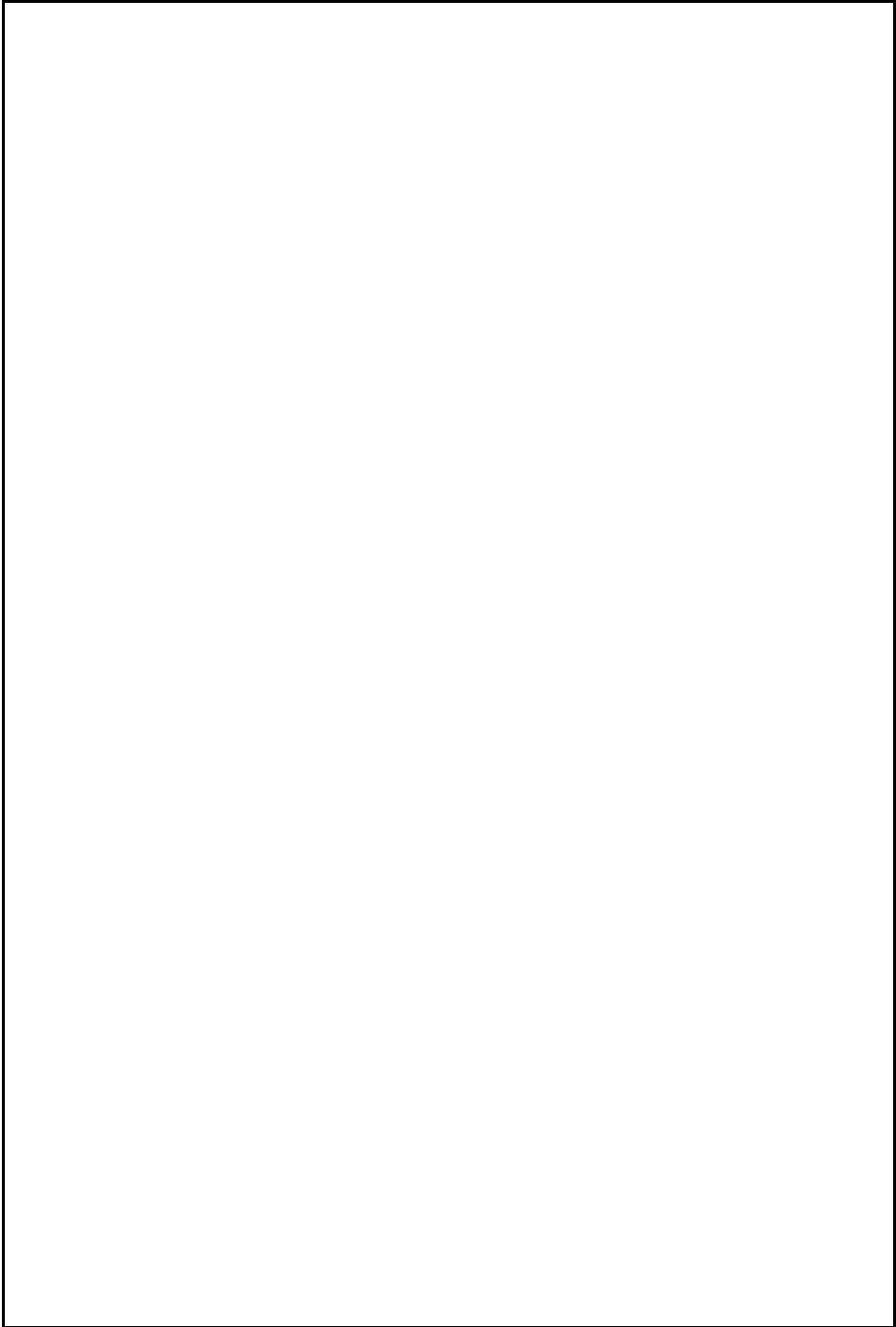

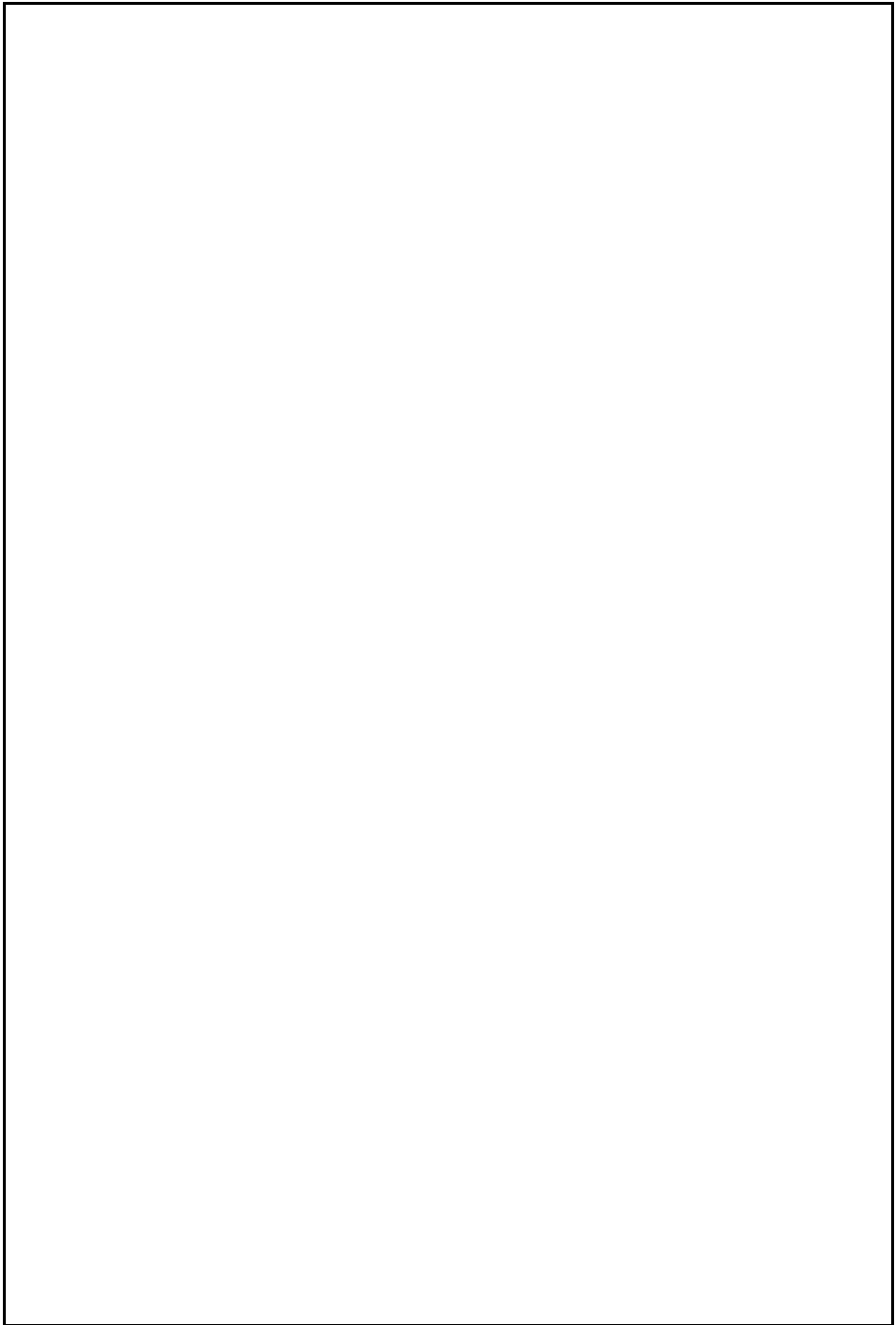

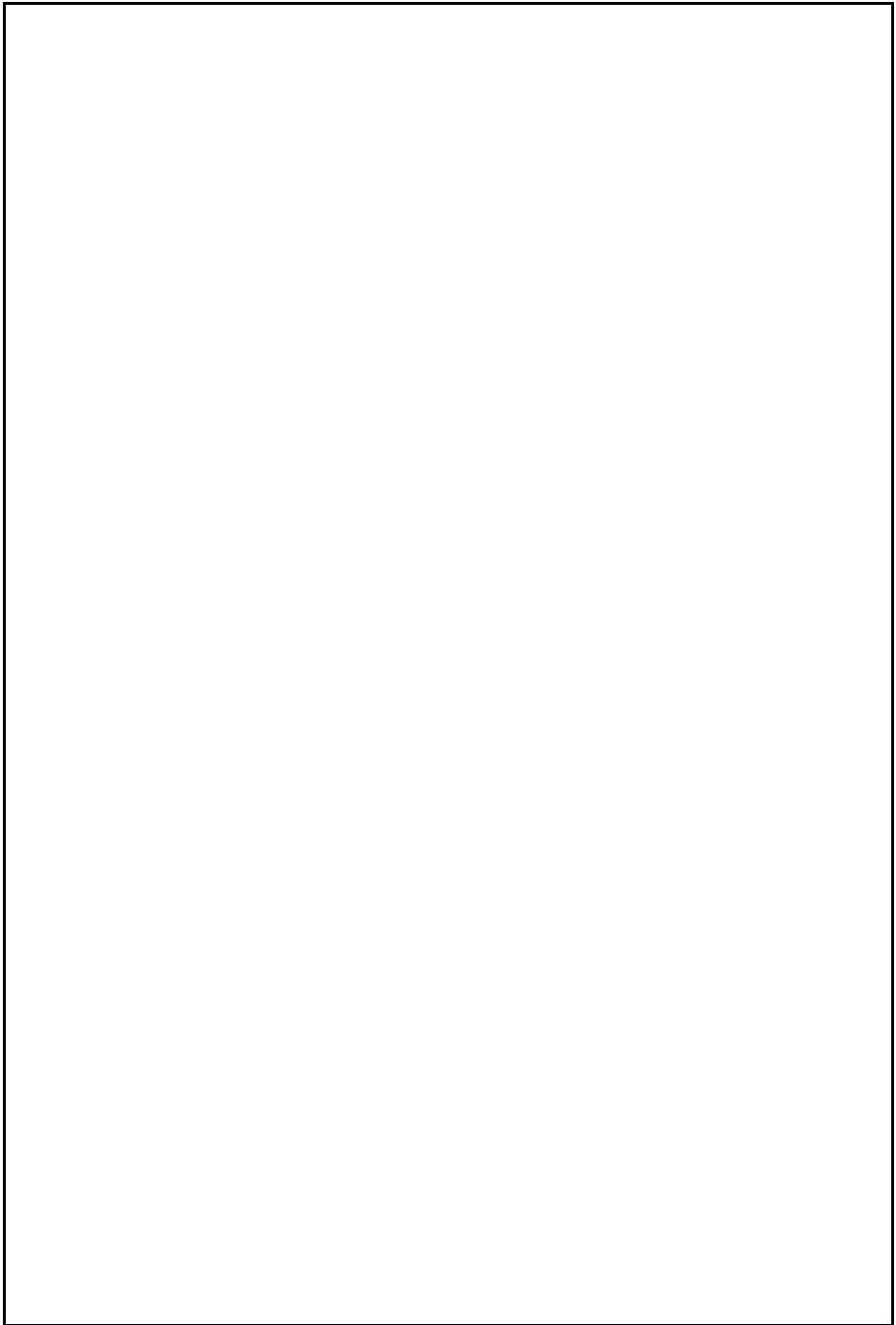



## REMOTE OPERATION CARD

The card below is provided as a quick guide to remote operation. Cut it out and carry it with you when you go out.

<p><b>Remote Operation Guide</b></p> <p><b>SHARP®</b></p> <ol style="list-style-type: none"><li>1. Call your fax from a touch-tone telephone, and press <b>#</b> when the outgoing message begins.</li><li>2. Enter your remote code: <input type="text"/> <input type="text"/> <input type="text"/> .</li><li>3. Press <b>#</b> .</li><li>4. After listening to your messages, you can either hang up to save them, or enter one of the commands on the reverse side.</li></ol>
--



# **SHARP®**

**SHARP CORPORATION OF AUSTRALIA PTY.LTD.**

**A.C.N. 003 039 405**

**1 Huntingwood Drive, Huntingwood, Blacktown, N.S.W., 2148**

**SHARP CORPORATION**

PRINTED IN THAILAND  
(TINSE4432XHTZ)

## Free Manuals Download Website

<http://myh66.com>

<http://usermanuals.us>

<http://www.somanuals.com>

<http://www.4manuals.cc>

<http://www.manual-lib.com>

<http://www.404manual.com>

<http://www.luxmanual.com>

<http://aubethermostatmanual.com>

Golf course search by state

<http://golfingnear.com>

Email search by domain

<http://emailbydomain.com>

Auto manuals search

<http://auto.somanuals.com>

TV manuals search

<http://tv.somanuals.com>