

# SHARP SERVICE MANUAL

No. S70I560LE920U/

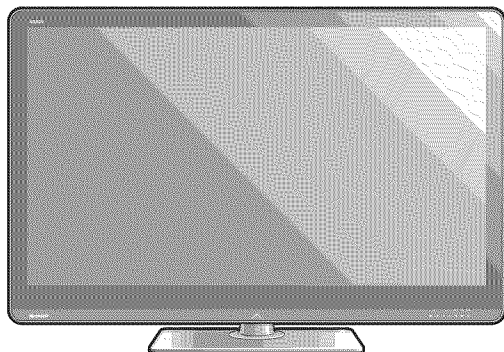

## LCD COLOR TELEVISION

# MODELS LC-52LE920UN LC-60LE920UN

In the interests of user-safety (Required by safety regulations in some countries) the set should be restored to its original condition and only parts identical to those specified should be used.

### CONTENTS

#### SAFETY PRECAUTION

IMPORTANT SERVICE SAFETY PRECAUTION.....i	
PRECAUTIONS A PRENDRE LORS DE LA REPARATION.....ii	
PRECAUTIONS FOR USING LEAD-FREE SOLDER.....iii	

#### OUTLINE

MAJOR SERVICE PARTS.....iv	
----------------------------	--

#### CHAPTER 1. SPECIFICATIONS

[1] SPECIFICATIONS.....1-1	
----------------------------	--

#### CHAPTER 2. OPERATION MANUAL

[1] Parts Name.....2-1	
[2] OPERATION MANUAL.....2-3	

#### CHAPTER 3. DIMENSIONS

[1] DIMENSIONS (LC-52LE920UN).....3-1	
[2] DIMENSIONS (LC-60LE920UN).....3-2	

#### CHAPTER 4. REMOVING OF MAJOR PARTS

[1] REMOVING OF MAJOR PARTS (LC-52LE920UN).....4-1	
---	--

[2] REMOVING OF MAJOR PARTS (LC-60LE920UN).....4-6	
[3] Caution Cleaning Glass.....4-11	
[4] How to replace the touch key sensor PWB.....4-13	

#### CHAPTER 5. ADJUSTMENT

[1] ADJUSTMENT PROCEDURE.....5-1	
[2] PUBLIC MODE SETTING PROCEDURE.....5-15	

#### CHAPTER 6. TROUBLESHOOTING TABLE

[1] TROUBLESHOOTING TABLE.....6-1	
[2] LED flashing specification at the time of an error (Center icon LED used).....6-14	

#### CHAPTER 7. MAJOR IC INFORMATIONS

[1] MAJOR IC INFORMATIONS.....7-1	
-----------------------------------	--

#### CHAPTER 8. OVERALL WIRING/SYSTEM BLOCK DIAGRAM

[1] OVERALL WIRING DIAGRAM.....8-1	
[2] SYSTEM BLOCK DIAGRAM.....8-2	

#### Parts Guide

Parts marked with "⚠" are important for maintaining the safety of the set. Be sure to replace these parts with specified ones for maintaining the safety and performance of the set.

## SHARP CORPORATION

Download from [Www.Somanuals.com](http://Www.Somanuals.com). All Manuals Search And Download.

This document has been published to be used for after sales service only.  
The contents are subject to change without notice.

## SAFETY PRECAUTION

### IMPORTANT SERVICE SAFETY PRECAUTION

- Service work should be performed only by qualified service technicians who are thoroughly familiar with all safety checks and the servicing guidelines which follow:

#### ■WARNING

- For continued safety, no modification of any circuit should be attempted.
- Disconnect AC power before servicing.

**CAUTION: FOR CONTINUED PROTECTION AGAINST A RISK OF FIRE REPLACE ONLY WITH SAME TYPE FUSE.**

F7000 (250V 5A)

F7001 (250V 5A)

#### ■BEFORE RETURNING THE RECEIVER (Fire & Shock Hazard)

Before returning the receiver to the user, perform the following safety checks:

- Inspect all lead dress to make certain that leads are not pinched, and check that hardware is not lodged between the chassis and other metal parts in the receiver.
- Inspect all protective devices such as non-metallic control knobs, insulation materials, cabinet backs, adjustment and compartment covers or shields, isolation resistor-capacitor networks, mechanical insulators, etc.
- To be sure that no shock hazard exists, check for leakage current in the following manner.
  - Plug the AC cord directly into a 120 volt AC outlet.

- Using two clip leads, connect a 1.5k ohm, 10 watt resistor paralleled by a 0.15μF capacitor in series with all exposed metal cabinet parts and a known earth ground, such as electrical conduit or electrical ground connected to an earth ground.
- Use an AC voltmeter having with 5000 ohm per volt, or higher, sensitivity or measure the AC voltage drop across the resistor.
- Connect the resistor connection to all exposed metal parts having a return to the chassis (antenna, metal cabinet, screw heads, knobs and control shafts, escutcheon, etc.) and measure the AC voltage drop across the resistor.

All checks must be repeated with the AC cord plug connection reversed. (If necessary, a nonpolarized adaptor plug must be used only for the purpose of completing these checks.)

Any reading of 0.75 Vrms (this corresponds to 0.5 mA rms AC.) or more is excessive and indicates a potential shock hazard which must be corrected before returning the monitor to the owner.

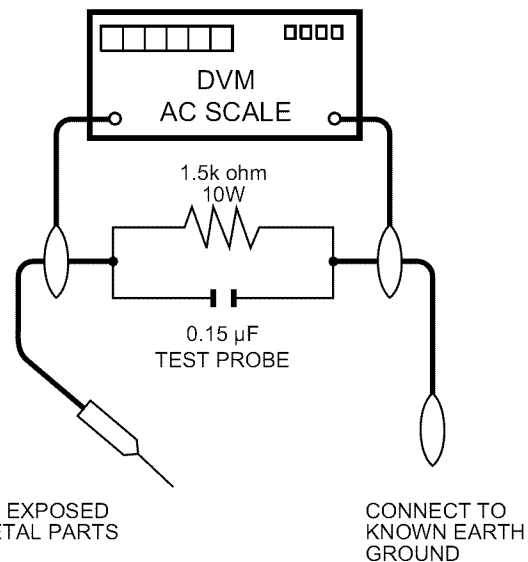

#### SAFETY NOTICE

Many electrical and mechanical parts in LCD color television have special safety-related characteristics.

These characteristics are often not evident from visual inspection, nor can protection afforded by them be necessarily increased by using replacement components rated for higher voltage, wattage, etc.

Replacement parts which have these special safety characteristics are identified in this manual; electrical components having such features are identified by "⚠" and shaded areas in the Replacement Parts List and Schematic Diagrams.

For continued protection, replacement parts must be identical to those used in the original circuit.

The use of a substitute replacement parts which do not have the same safety characteristics as the factory recommended replacement parts shown in this service manual, may create shock, fire or other hazards.

## PRECAUTIONS A PRENDRE LORS DE LA REPARATION

■ Ne peut effectuer la réparation qu' un technicien spécialisé qui s'est parfaitement accoutumé à toute vérification de sécurité et aux conseils suivants.

### ■ AVERTISSEMENT

1. N'entreprendre aucune modification de tout circuit. C'est dangereux.
2. Débrancher le récepteur avant toute réparation.

**PRECAUTION: POUR LA PROTECTION CONTINUE CONTRE LES RISQUES D'INCENDIE, REMPLACER LE FUSIBLE**

F7000 (250V 5A)

F7001 (250V 5A)

### ■ VERIFICATIONS CONTRE L'INCEN-DIE ET LE CHOC ELECTRIQUE

Avant de rendre le récepteur à l'utilisateur, effectuer les vérifications suivantes.

3. Inspecter tous les faisceaux de câbles pour s'assurer que les fils ne soient pas pincés ou qu'un outil ne soit pas placé entre le châssis et les autres pièces métalliques du récepteur.
4. Inspecter tous les dispositifs de protection comme les boutons de commande non-métalliques, les isolants, le dos du coffret, les couvercles ou blindages de réglage et de compartiment, les réseaux de résistancecapacité, les isolateurs mécaniques, etc.
5. S'assurer qu'il n'y ait pas de danger d'électrocution en vérifiant la fuite de courant, de la façon suivante:
  - Brancher le cordon d'alimentation directement à une prise de courant de 120V. (Ne pas utiliser de transformateur d'isolation pour cet essai).

- A l'aide de deux fils à pinces, brancher une résistance de 1.5 k $\Omega$  10 watts en parallèle avec un condensateur de 0.15 $\mu$ F en série avec toutes les pièces métalliques exposées du coffret et une terre connue comme une conduite électrique ou une prise de terre branchée à la terre.
- Utiliser un voltmètre CA d'une sensibilité d'au moins 5000 $\Omega$ /V pour mesurer la chute de tension en travers de la résistance.
- Toucher avec la sonde d'essai les pièces métalliques exposées qui présentent une voie de retour au châssis (antenne, coffret métallique, tête des vis, arbres de commande et des boutons, écusson, etc.) et mesurer la chute de tension CA en-travers de la résistance. Toutes les vérifications doivent être refaites après avoir inversé la fiche du cordon d'alimentation. (Si nécessaire, une prise d'adpatation non polarisée peut être utilisée dans le but de terminer ces vérifications.)  
La tension de pointe mesurée ne doit pas dépasser 0.75V (correspondante au courant CA de pointe de 0.5mA). Dans le cas contraire, il y a une possibilité de choc électrique qui doit être supprimée avant de rendre le récepteur au client.

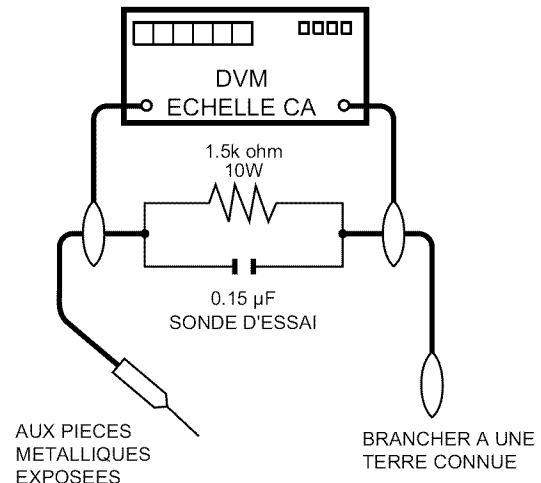

### AVIS POUR LA SECURITE

De nombreuses pièces, électriques et mécaniques, dans les téléviseur ACL présentent des caractéristiques spéciales relatives à la sécurité, qui ne sont souvent pas évidentes à vue. Le degré de protection ne peut pas être nécessairement augmentée en utilisant des pièces de remplacement étalonnées pour haute tension, puissance, etc.

Les pièces de remplacement qui présentent ces caractéristiques sont identifiées dans ce manuel; les pièces électriques qui présentent ces particularités sont identifiées par la marque "⚠" et hachurées dans la liste des pièces de remplacement et les diagrammes schématiques.

Pour assurer la protection, ces pièces doivent être identiques à celles utilisées dans le circuit d'origine. L'utilisation de pièces qui n'ont pas les mêmes caractéristiques que les pièces recommandées par l'usine, indiquées dans ce manuel, peut provoquer des électrocutions, incendies, radiations X ou autres accidents.

**PRECAUTIONS FOR USING LEAD-FREE SOLDER**

**■Employing lead-free solder**

- "PWBs" of this model employs lead-free solder. The LF symbol indicates lead-free solder, and is attached on the PWBs and service manuals. The alphabetical character following LF shows the type of lead-free solder.

Example:



Indicates lead-free solder of tin, silver and copper.



Indicates lead-free solder of tin, silver and copper.

**■Using lead-free wire solder**

- When fixing the PWB soldered with the lead-free solder, apply lead-free wire solder. Repairing with conventional lead wire solder may cause damage or accident due to cracks.

As the melting point of lead-free solder (Sn-Ag-Cu) is higher than the lead wire solder by 40 °C, we recommend you to use a dedicated soldering bit, if you are not familiar with how to obtain lead-free wire solder or soldering bit, contact our service station or service branch in your area.

**■Soldering**

- As the melting point of lead-free solder (Sn-Ag-Cu) is about 220 °C which is higher than the conventional lead solder by 40 °C, and as it has poor solder wettability, you may be apt to keep the soldering bit in contact with the PWB for extended period of time. However, Since the land may be peeled off or the maximum heat-resistance temperature of parts may be exceeded, remove the bit from the PWB as soon as you confirm the steady soldering condition.

Lead-free solder contains more tin, and the end of the soldering bit may be easily corroded. Make sure to turn on and off the power of the bit as required.

If a different type of solder stays on the tip of the soldering bit, it is alloyed with lead-free solder. Clean the bit after every use of it.

When the tip of the soldering bit is blackened during use, file it with steel wool or fine sandpaper.

- Be careful when replacing parts with polarity indication on the PWB silk.

Lead-free wire solder for servicing

PARTS CODE	PRICE RANK	PART DELIVERY	DESCRIPTION
ZHNDai123250E	BL	J	φ0.3mm 250g (1roll)
ZHNDai126500E	BK	J	φ0.6mm 500g (1roll)
ZHNDai12801KE	BM	J	φ1.0mm 1kg (1roll)

## OUTLINE

### MAJOR SERVICE PARTS

#### ■PWB UNIT

Ref No.	Part No.	Description
N	DKEYMF452FM20	MAIN Unit*1
N	DUNTKF493FM01	ICON Unit
N	DUNTKF493FM02	LOGO Unit
N	DUNTKF494FM01	R/C, LED Unit
N	RUNTKA690WJQZ	TOUCH SENSOR Unit*2
N	RDENCA395WJQZ	POWER Unit
N	RUNTK4570TPZA	LCD CONTROL Unit
N	RUNTK4433TPZA	LED DRIVE Unit (LC-52LE920UN)
N	RUNTK4433TPZZ	LED DRIVE Unit (LC-60LE920UN)

NOTE: \*1 Replace MAIN PWB Units (DKEYMF452FM20) in case of IC8455, IC8401 or IC3302 failure.

\*2 TOUCH SENSOR Unit (RUNTKA690WJQZ) reuse will be impossible, once it is stuck on front glass and exfoliates.

Therefore, please exchange of a touch sensor unit in the case of front glass exchange.

#### ■OTHER UNIT

Ref No.	Part No.	Description
N	R1LK520D3LWB0Z	52" LCD Panel Module Unit (LK520D3LWB0Z) (LC-52LE920UN)
N	R1LK600D3LW30Z	60" LCD Panel Module Unit (LK600D3LW30Z) (LC-60LE920UN)

#### ■IC FOR EXCLUSIVE USE OF THE SERVICE

Ref No.	Part No.	Description	Q'ty
IC509	VHIR24002AS1YS	R1EX24002ASAS0A RGB EDID	1
IC2002	RH-iXC786WJNHQ	R5F364A6NFB Monitor Microcomputer	1

#### ■SERVICE JIGS

Ref No.	Part No.	Description	Q'ty
N	QCNW-C222WJQZ	Connecting Cord L=1000mm 80pin LCD Control Unit to LCD Panel Unit	2
N	QCNW-H184WJQZ	Connecting Cord L=1000mm 12pin Main to Power Unit (PD)	1
N	QCNW-F676WJQZ	Connecting Cord L=1000mm 41pin Main to LCD Control Unit (LW)	1
N	QCNW-G405WJQZ	Connecting Cord L=1000mm 4pin Power to LCD Control Unit (PL)	1
N	QCNW-G394WJQZ	Connecting Cord L=1000mm 9pin Main to LED Drive Unit (LB)	1
N	QCNW-K593WJQZ	Connecting Cord L=1000mm 13pin Power to LED Drive Unit (LA)	1

**CHAPTER 1. SPECIFICATIONS****[1] SPECIFICATIONS**

Item		Model: LC-52LE920UN	Model: LC-60LE920UN	
LCD panel	Size	52" Class (52 <sup>1</sup> / <sub>32</sub> " Diagonal)	60" Class (60 <sup>1</sup> / <sub>32</sub> " Diagonal)	
	Resolution	2,073,600 pixels (1,920 x 1,080)		
TV Function	TV-standard (CCIR)	American TV Standard ATSC/NTSC System		
	Receiving Channel	VHF/UHF	VHF 2-13ch, UHF 14-69ch	
		CATV	1-135ch (non-scrambled channel only)	
		Digital Terrestrial Broadcast (8VSB)	2-69ch	
		Digital cable <sup>*1</sup> (64/256 QAM)	1-135ch (non-scrambled channel only)	
Audio multiplex	BTSC System			
Audio out	10W x 2 + 15 W (WF)			
Terminals	Back panel vertical inputs	VIDEO	AV in (Ø 3.5 mm to 3 RCA AV cable)	
		PC IN	ANALOG RGB (PC) in (15-pin mini D-sub female connector), Audio in (Ø 3.5 mm stereo jack)	
		HDMI 1	HDMI in with HDCP, Audio in (Ø 3.5 mm stereo jack)	
		HDMI 2	HDMI in with HDCP	
		HDMI 3	HDMI in with HDCP	
		HDMI 4	HDMI in with HDCP	
		AUDIO IN	Audio in (Ø 3.5 mm stereo jack)	
		AUDIO OUT	Audio out (Ø 3.5 mm stereo jack)	
		DIGITAL AUDIO OUTPUT	Optical Digital audio output x 1 (PCM/Dolby Digital)	
		ETHERNET	Network connector	
		USB 1	Photo/Music/Video mode, Software update	
	USB 2	Photo/Music/Video mode, Software update		
	Back panel horizontal inputs	COMPONENT	COMPONENT in	
		ANT/CABLE	75 Ω Unbalance, F Type g 1 for Analog (VHF/UHF/CATV) and Digital (AIR/CABLE)	
RS-232C		9-pin D-sub male connector		
OSD language	English/French/Spanish			
Power Requirement	AC 120 V, 60 Hz			
Power Consumption	180 W (0.5 W Standby with AC 120 V)	230 W (0.5 W Standby with AC 120 V)		
Weight	TV + stand	86.0 lbs./39.0 kg	121.3 lbs./55.0 kg	
	TV only	73.9 lbs./33.5 kg	98.1 lbs./44.5 kg	
Dimension <sup>*2</sup> (W x H x D)	TV + stand	49 <sup>5</sup> / <sub>8</sub> x 33 <sup>29</sup> / <sub>32</sub> x 13 <sup>25</sup> / <sub>64</sub> inch	56 <sup>21</sup> / <sub>32</sub> x 38 <sup>25</sup> / <sub>64</sub> x 14 <sup>1</sup> / <sub>2</sub> inch	
	TV only	49 <sup>5</sup> / <sub>8</sub> x 31 <sup>15</sup> / <sub>16</sub> x 1 <sup>35</sup> / <sub>64</sub> inch	56 <sup>21</sup> / <sub>32</sub> x 35 <sup>61</sup> / <sub>64</sub> x 1 <sup>9</sup> / <sub>16</sub> inch	
Operating temperature	+32°F to +104°F (0°C to +40°C)			

<sup>\*1</sup> Emergency alert messages via Cable are unreceivable.

<sup>\*2</sup> The dimensional drawings are shown on the inside back cover.

- As part of policy of continuous improvement, SHARP reserves the right to make design and specification changes for product improvement without prior notice. The performance specification figures indicated are nominal values of production units. There may be some deviations from these values in individual units.

# CHAPTER 2. OPERATION MANUAL

## [1] Parts Name

### TV (Front)

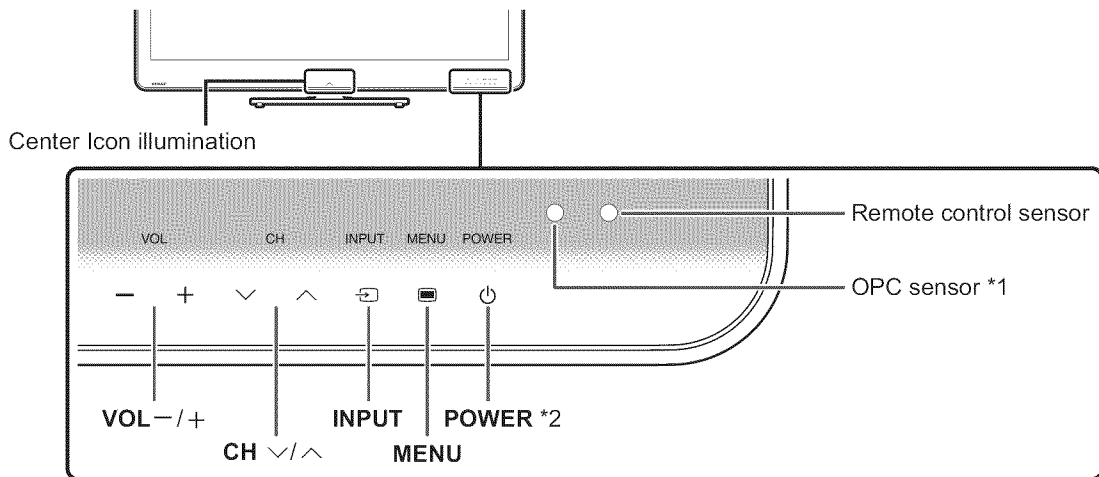

\*1 OPC: Optical Picture Control  
 \*2 Using the touch sensor panel.

### TV (Rear)

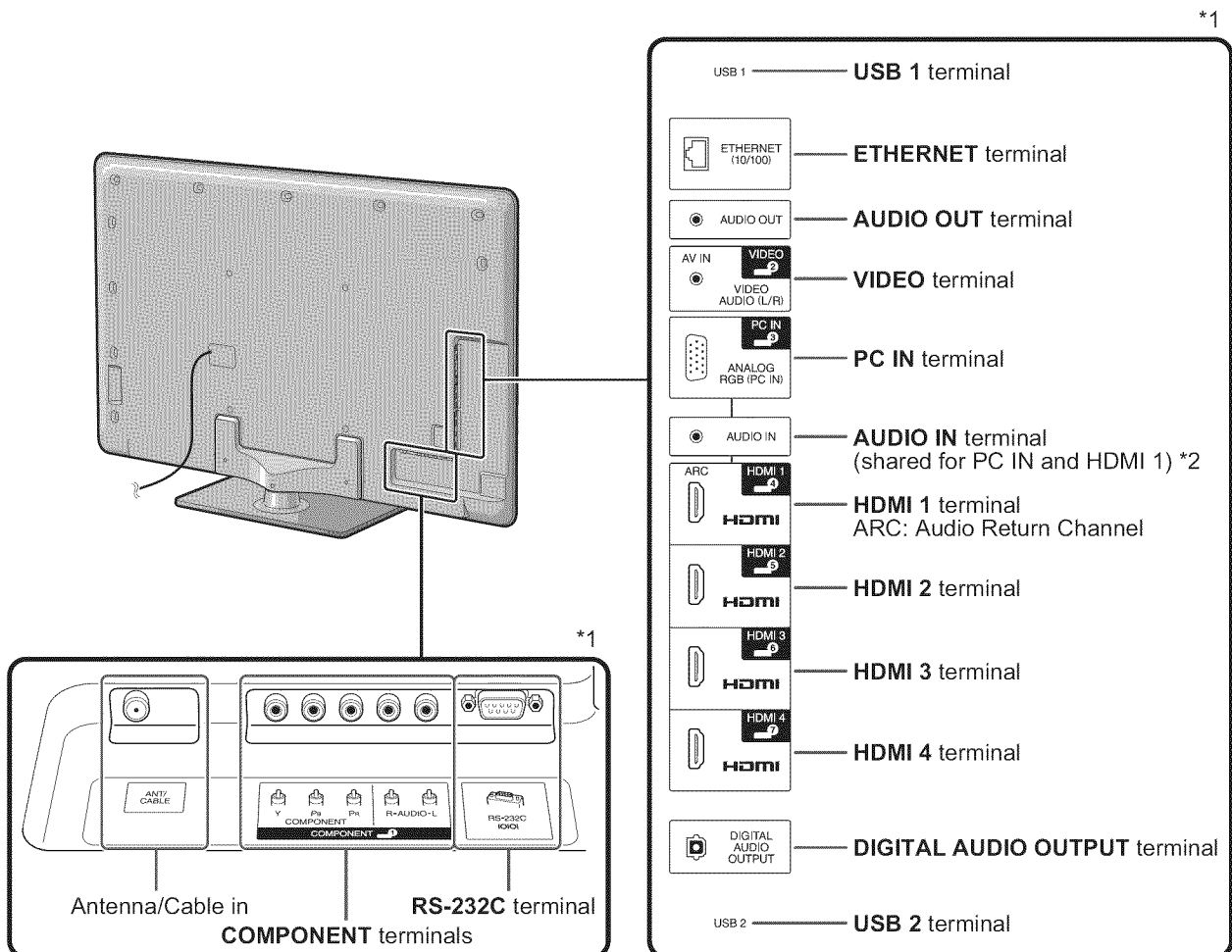

\*1 External equipment connection.

\*2 Details on the Audio Select function.

## Remote Control Unit

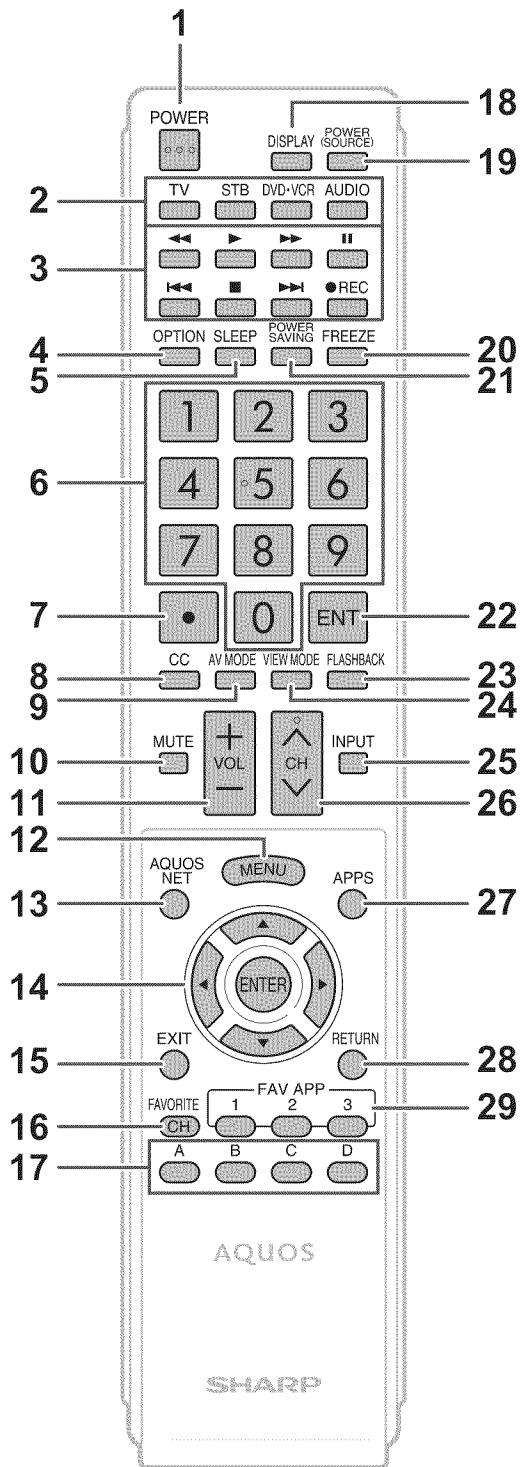

- 1 **POWER:** Switch the TV power on or enter standby.
- 2 **TV, STB, DVD-VCR, AUDIO:** Switches the remote control for TV, STB, DVD, BD, VCR and AUDIO operation.  
\* To enter the code registration mode, you need to press an appropriate button (**STB, DVD-VCR** or **AUDIO**) and **DISPLAY** at the same time.
- 3 **External equipment operational buttons:** Operate the external equipment.
- 4 **OPTION:** Display the Link Operation Menu screen. This button will function only when AQUOS LINK is used.
- 5 **SLEEP:** Set the sleep timer.
- 6 **0-9:** Set the channel.
- 7 **• (DOT):**
- 8 **CC:** Display captions from a closed-caption source.
- 9 **AV MODE:** Select an audio or video setting.
- 10 **MUTE:** Mute the sound.
- 11 **VOL + / - :** Set the volume.
- 12 **MENU:** Display the menu screen.
- 13 **AQUOS NET:** Switches the display to the Sidebar Widget, TV + Web, Web or TV screen.
- 14 **▲/▼/◀/▶, ENTER:** Select a desired item on the screen.
- 15 **EXIT:** Turn off the menu screen.
- 16 **FAVORITE CH:** Set the favorite channels.
- 17 **A, B, C, D:** Select 4 preset favorite channels in 4 different categories.  
While watching, you can toggle the selected channels by pressing **A, B, C** and **D**.
- 18 **DISPLAY:** Display the channel information.
- 19 **POWER (SOURCE):** Turns the power of the external equipment on and off.
- 20 **FREEZE:** Set the still image. Press again to return to normal screen.
- 21 **POWER SAVING:** Select Power Saving settings.
- 22 **ENT:** Jumps to a channel after selecting with the **0-9** buttons.
- 23 **FLASHBACK:** Return to the previous channel or external input mode.
- 24 **VIEW MODE:** Select the screen size.
- 25 **INPUT:** Select a TV input source. (TV, COMPONENT, VIDEO, PC IN, HDMI 1, HDMI 2, HDMI 3, HDMI 4, USB)
- 26 **CH + / - :** Select the channel.
- 27 **APPS:** Display the application window.
- 28 **RETURN:** Return to the previous menu screen.
- 29 **FAV APP 1, 2, 3:** You can assign your favorite applications to these buttons.

### NOTE

- When using the remote control unit, point it at the TV.



## [2] OPERATION MANUAL

**Attaching the Stand (LC-52LE920UN Only)**

- Before attaching (or detaching) the stand, unplug the AC cord.
- Before performing work spread cushioning over the base area to lay the TV on. This will prevent it from being damaged.

**CAUTION**

- **Attach the stand in the correct direction.**
- **Do not remove the stand from the TV unless using an optional wall mount bracket to mount it.**
- **Be sure to follow the instructions. Incorrect installation of the stand may result in the TV falling over.**

- 1** Confirm that there are 9 screws (5 short screws and 4 long screws) supplied with the stand unit.

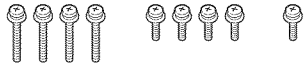

- 2** Attach the supporting post for the stand unit onto the base using the box for the stand unit as shown below.

- The supporting post attaches to the base at an off-centered location on the base. Be sure to attach the supporting post in the direction indicated below and attach the stand to the TV with the wider side of the base facing forward.

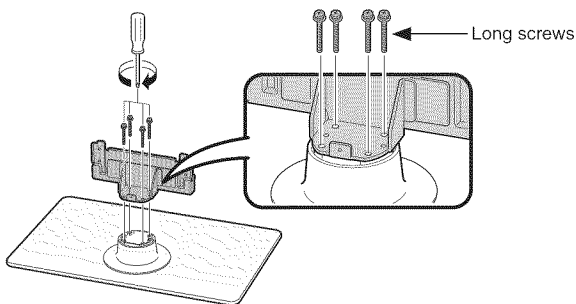

- 3** Insert the stand into the openings on the rear of the TV.

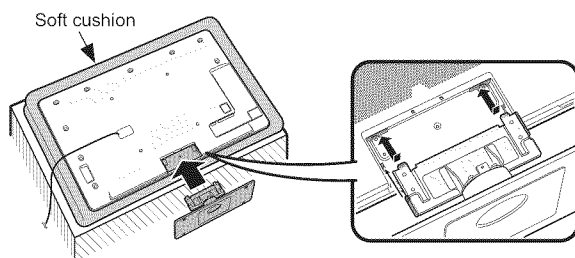

- 4** Insert and tighten the 4 screws into the 4 holes on the rear of the stand unit.

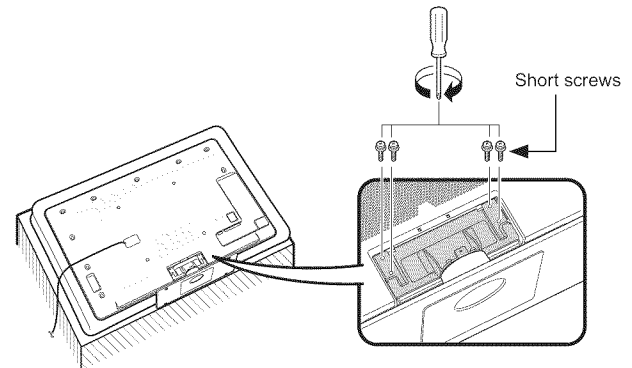

- 5** ① Insert the stand cover.  
② Insert the screw to secure the stand cover.

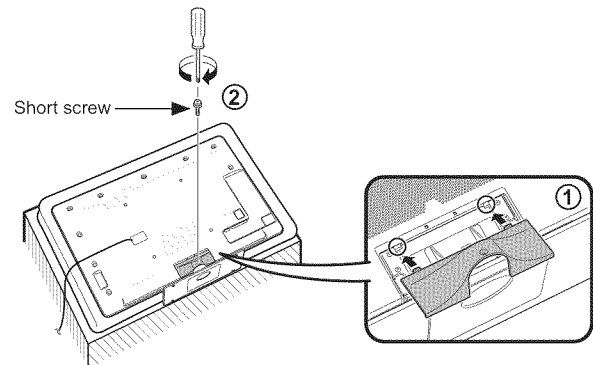

- NOTE** • To detach the stand, perform the steps in reverse order.

# CHAPTER 3. DIMENSIONS

## [1] DIMENSIONS (LC-52LE920UN)

Unit: inch (mm)

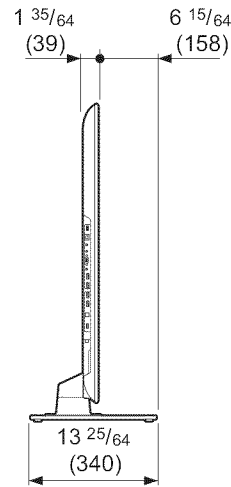
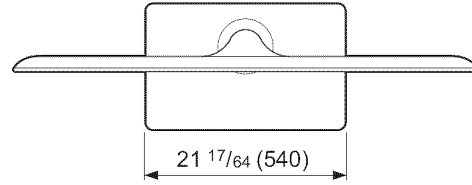
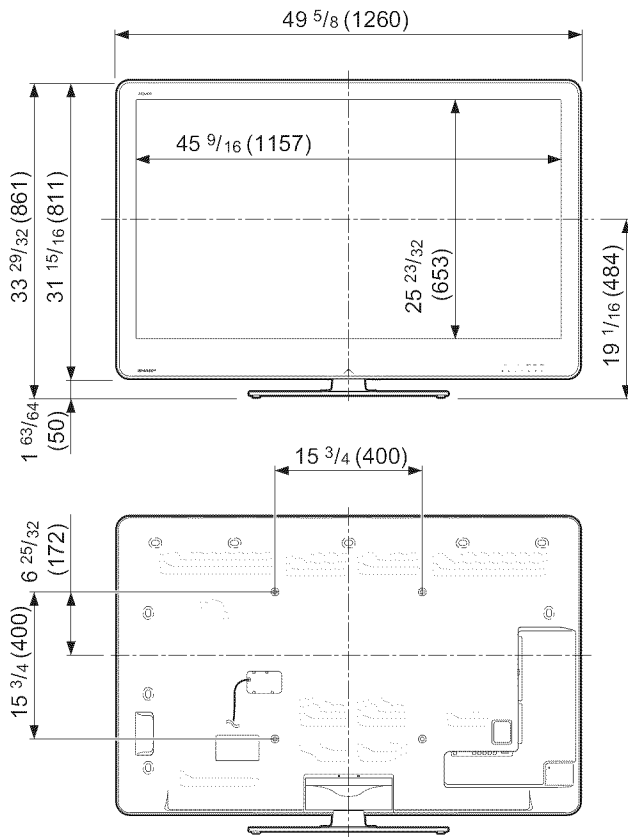

### AN-52AG4

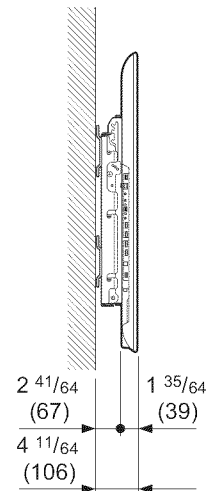

[2] DIMENSIONS (LC-60LE920UN)

Unit: inch (mm)

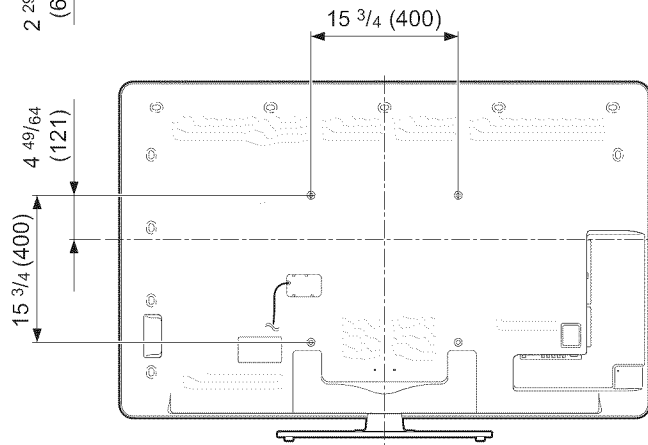
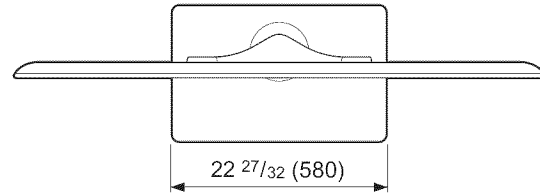
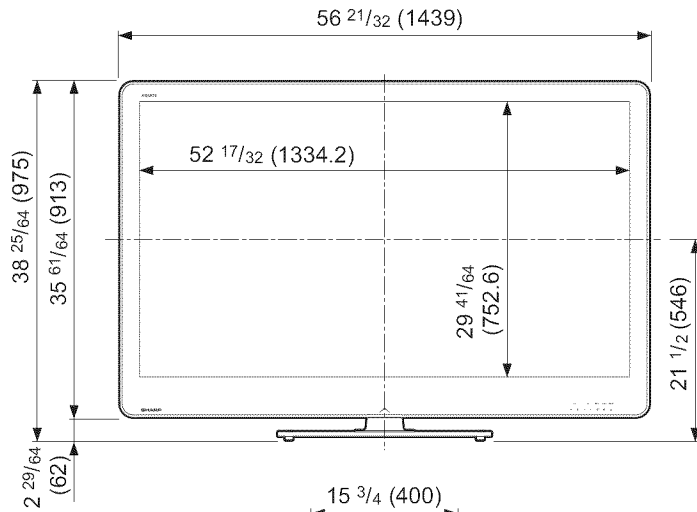

**AN-52AG4**

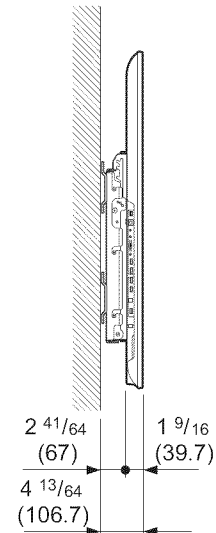
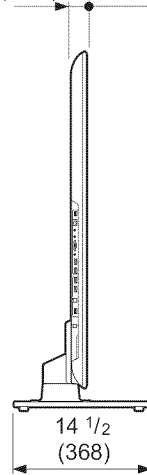

## CHAPTER 4. REMOVING OF MAJOR PARTS

### [1] REMOVING OF MAJOR PARTS (LC-52LE920UN)

#### 1. Removing of Stand Unit and Rear Cabinet Ass'y.

1. Remove the 1 lock screw ① and detach the Support Cover ②.
2. Remove the 4 lock screws ③ and detach the Stand Unit ④.
3. Remove the 1 lock screw ⑤ and detach the AC Cord Cover ⑥.
4. Disconnect AC Cord ⑦.
5. Remove the 4 lock screws ⑧, 4 lock screws ⑨, 1 lock screw ⑩ and 18 lock screws ⑪ and detach the Rear Cabinet Ass'y ⑫.

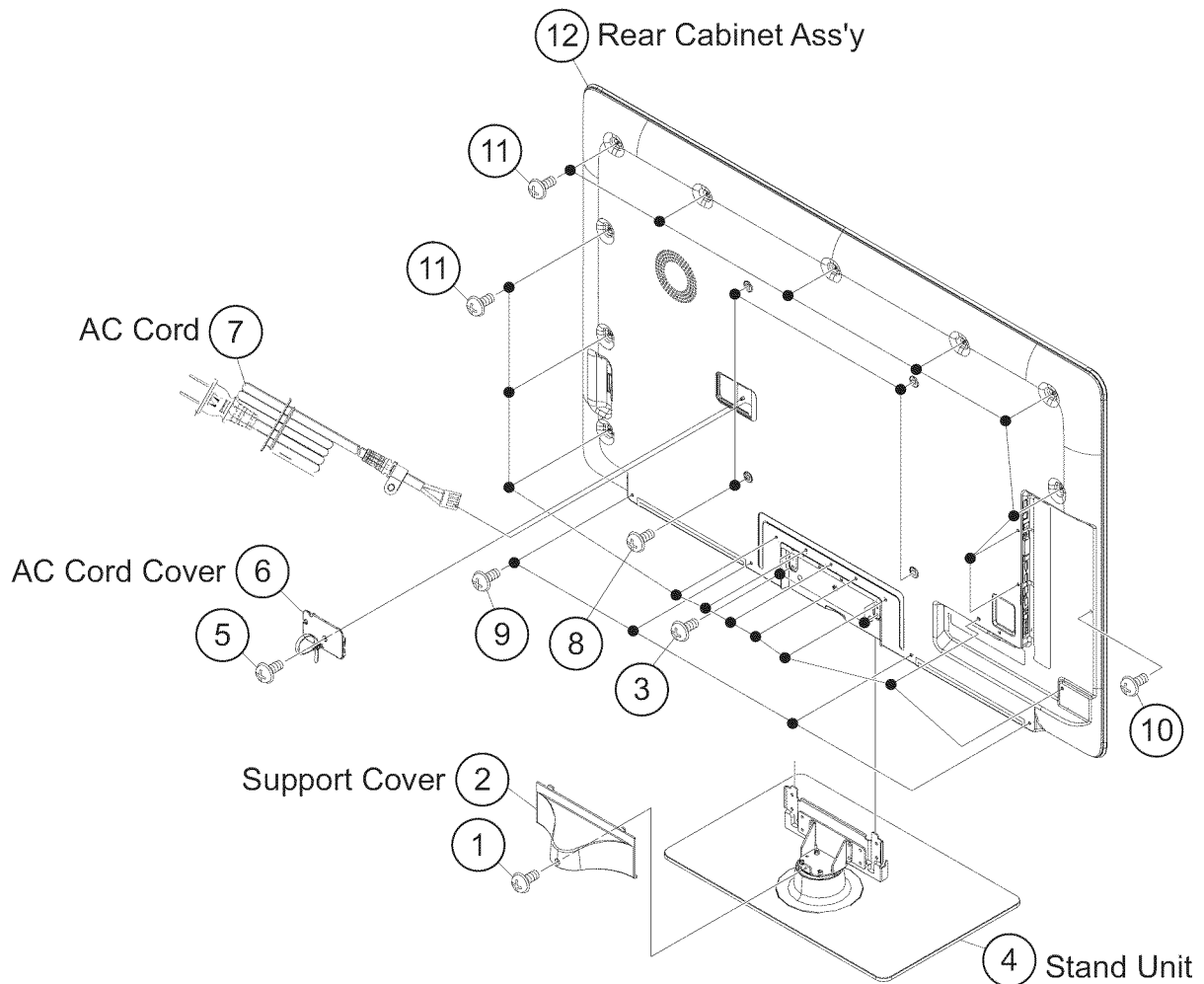

## 2. Removing of Speaker-L/R.

1. Remove the 2 lock screws ① and detach the Stand Cover ②.
2. Disconnect SP wire.
3. Detach the Speaker-L ③, Speaker-R ④.

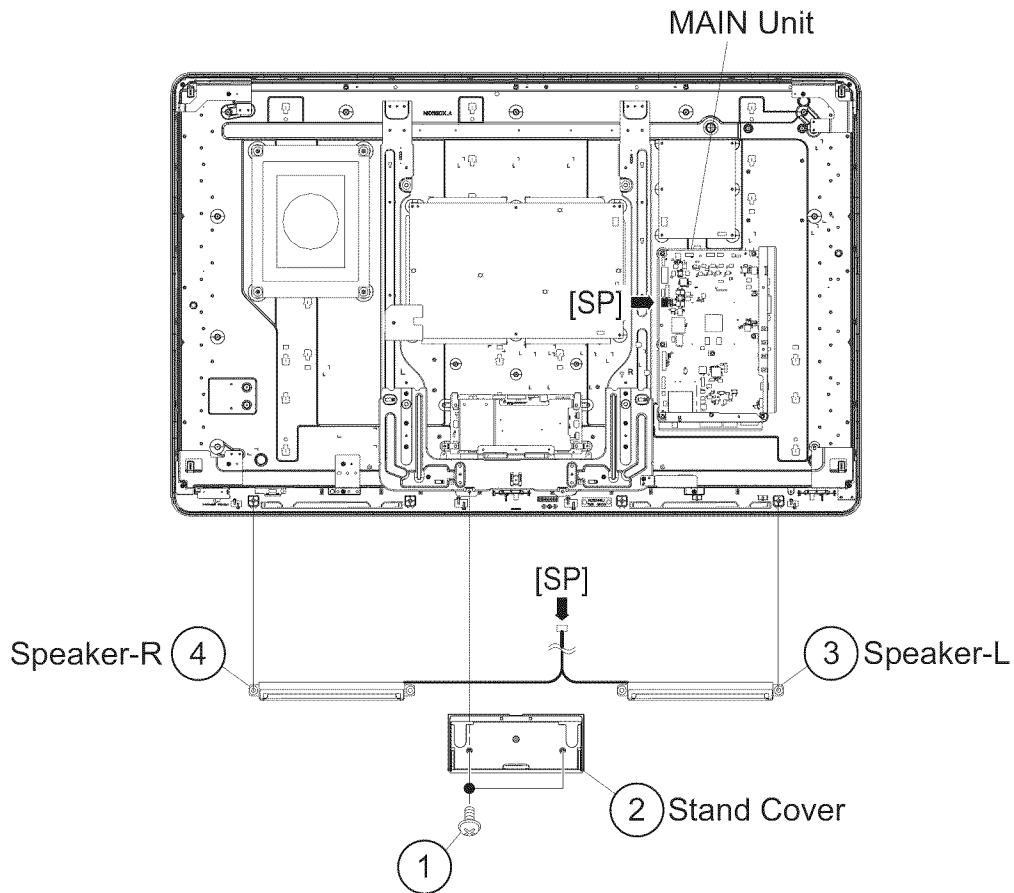

### 3. Removing of Connectors

1. Disconnect the following connectors from the MAIN Unit. (SB, LB, PD, LW, RA, RL)
2. Disconnect the following connectors from the POWER/LED Drive Unit. (LA, PD, PL)
3. Disconnect the following connectors from the LCD Control Unit. (LW, PL)

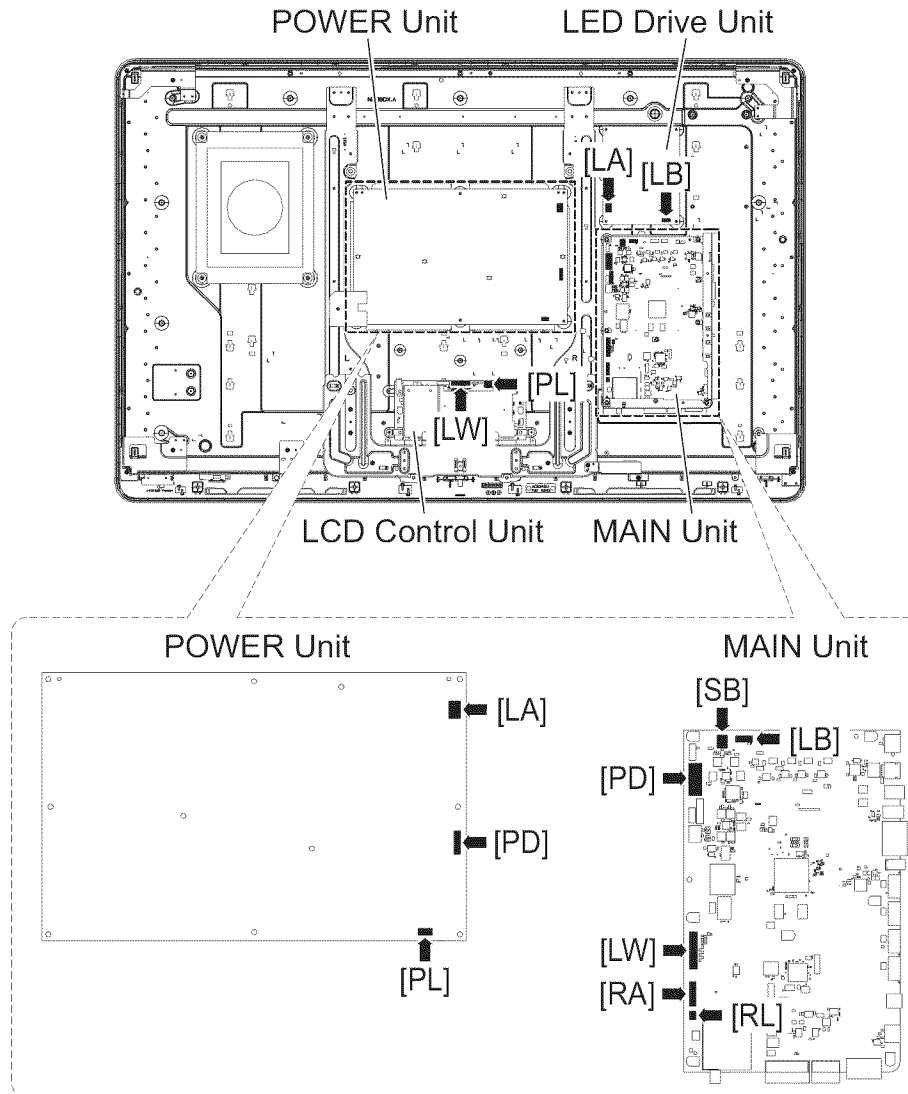

#### 4. Removing of MAIN Unit, POWER Unit, Woofer, Stand Angle, 52" LCD Panel Module Unit.

1. Remove the 7 lock screws ① and detach the MAIN Unit ②.
2. Remove the 2 lock screws ③ and detach the Terminal Cover (Bottom) ④.
3. Remove the 2 lock screws ⑤ and detach the Terminal Cover (Side) ⑥.
4. Remove the 6 lock screws ⑦ and detach the POWER Unit ⑧.
5. Remove the 4 lock screws ⑨ and detach the Sub Woofer ⑩.
6. Remove the 1 lock screw ⑪ and detach the LCD Fixing Angle (Bottom-R) ⑫.
7. Remove the 2 lock screws ⑬ and detach the LCD Fixing Angle (Top-L) ⑭.
8. Remove the 2 lock screws ⑮ and detach the LCD Fixing Angle (Top-R) ⑯.
9. Remove the 2 lock screws ⑰ and detach the LCD Fixing Angle (Bottom-L) ⑱.
10. Remove the 2 lock screws ⑲ and detach the LCD Fixing Angle (B-MA) ⑳.
11. Remove the 2 lock screws ㉑ and detach the LCD Fixing Angle (B-MB) ㉒.
12. Remove the 8 lock screws ㉓ and detach the Stand Angle ㉔.
13. Remove the 3 lock screws ㉕ and detach the BL Support Angle ㉖.
14. Remove the 6 lock screws ㉗ and detach the 52" LCD Panel Module Unit ㉘.

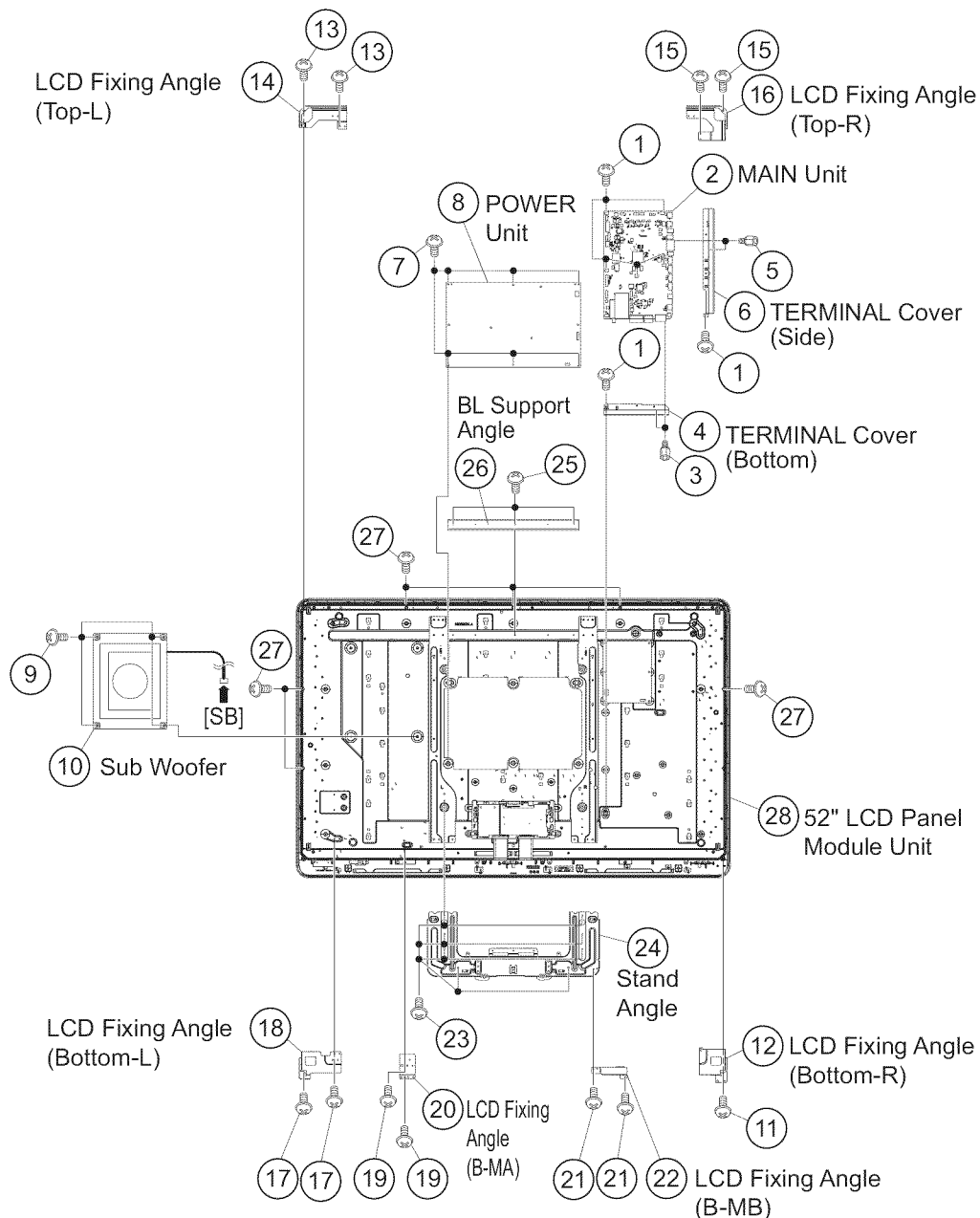

**5. Removing of R/C, LED Unit, ICON Unit, LOGO Unit, Front Cabinet Ass'y, Glass Front Panel Ass'y, TOUCH SENSOR Unit.**

1. Detach the R/C, LED Unit ①.
2. Detach the ICON Unit ②.
3. Detach the LOGO Unit ③.
4. Remove the 28 Hooks ④ and detach the Front Cabinet Ass'y ⑤
5. Detach the Glass Front Panel Ass'y ⑥.
6. Detach the Touch Sensor Unit ⑦.

NOTE: The Touch Sensor unit ⑦ removed once is not reusable.

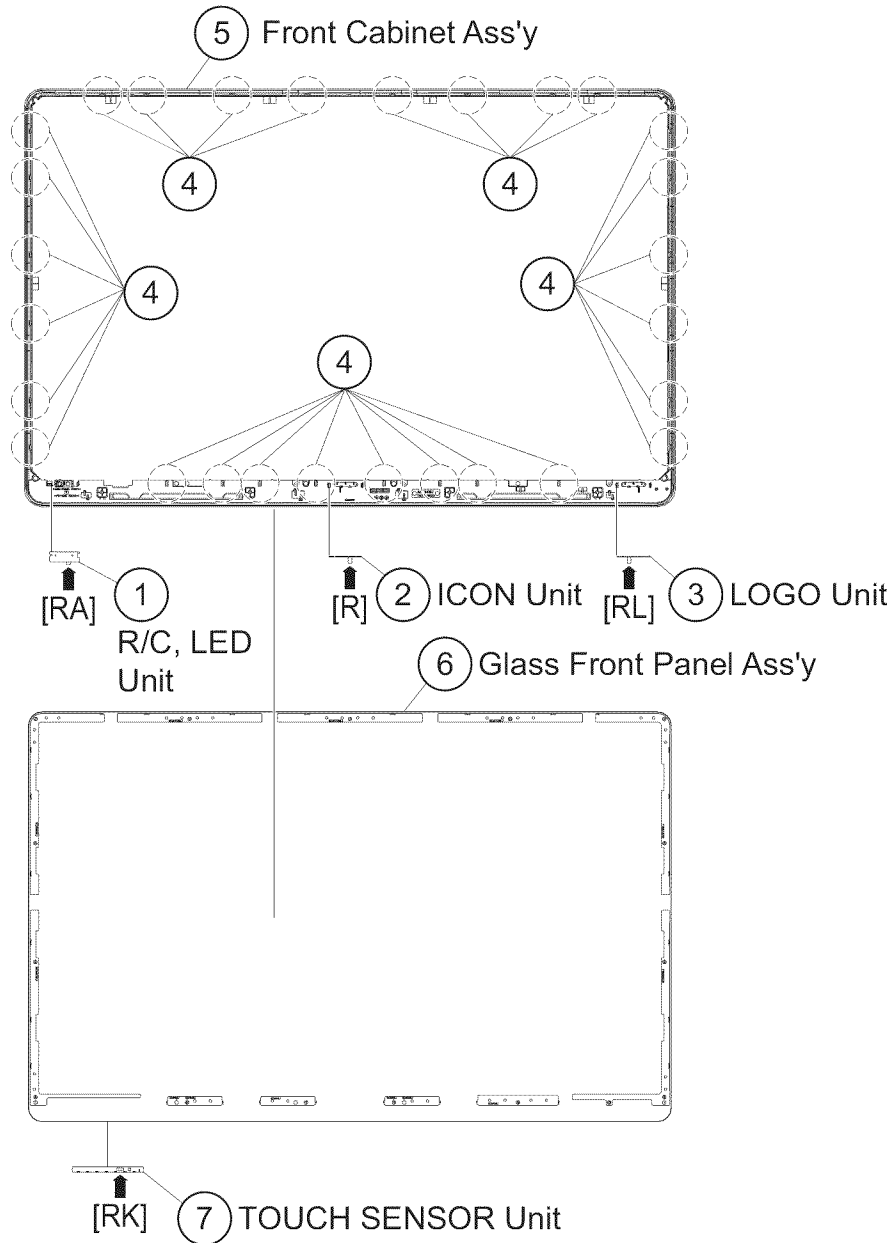



## [2] REMOVING OF MAJOR PARTS (LC-60LE920UN)

### 1. Removing of Stand Unit and Rear Cabinet Ass'y.

1. Remove the 3 lock screw ① and detach the Support Cover ②.
2. Remove the 4 lock screws ③ and detach the Stand Unit ④.
3. Remove the 1 lock screw ⑤ and detach the AC Cord Cover ⑥.
4. Disconnect AC Cord ⑦.
5. Remove the 4 lock screws ⑧, 7 lock screws ⑨, 2 lock screws ⑩ and 18 lock screws ⑪ and detach the Rear Cabinet Ass'y ⑫.

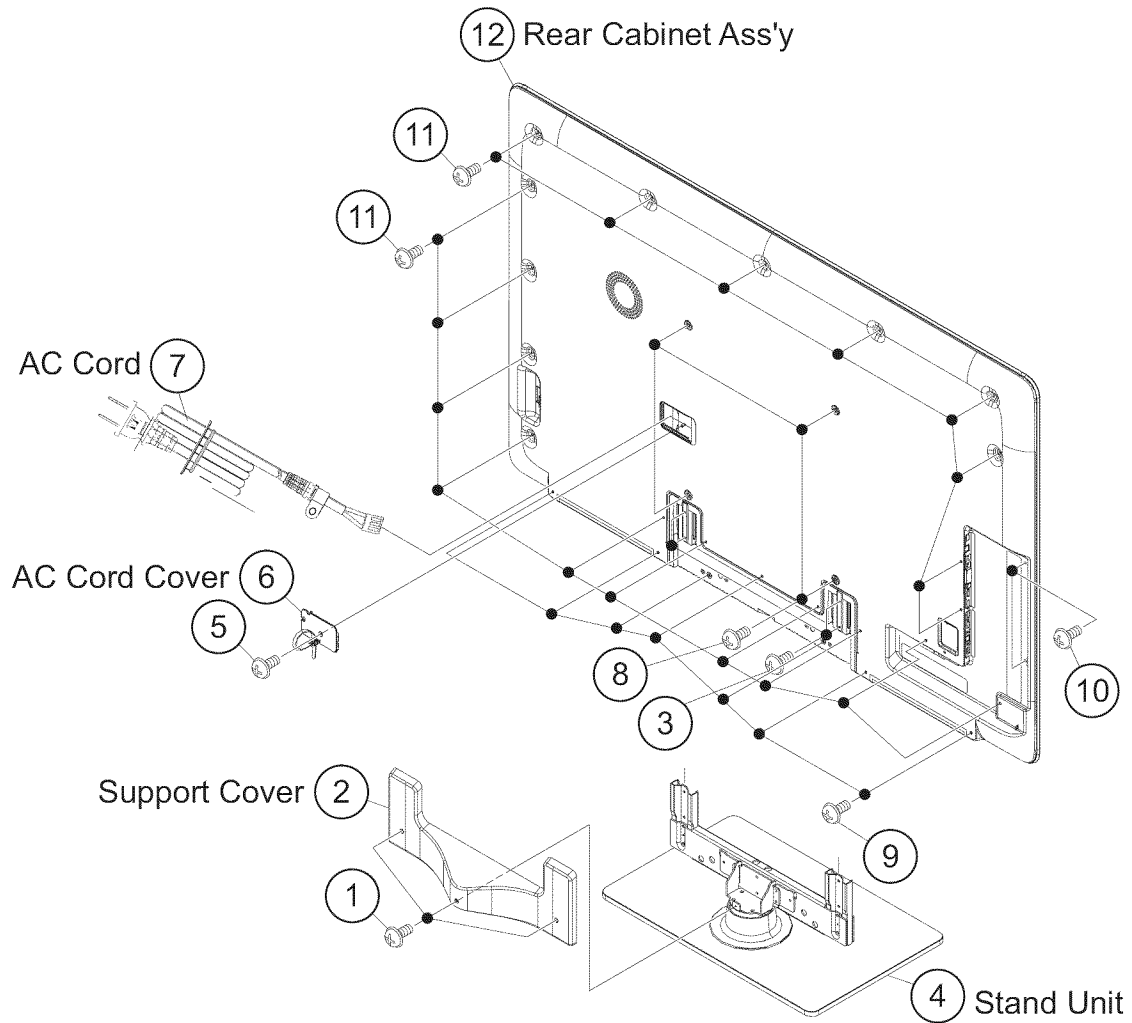

## 2. Removing of Speaker-L/R.

1. Remove the 2 lock screws ① and detach the Stand Cover ②.
2. Disconnect SP wire.
3. Detach the Speaker-L ③, Speaker-R ④.

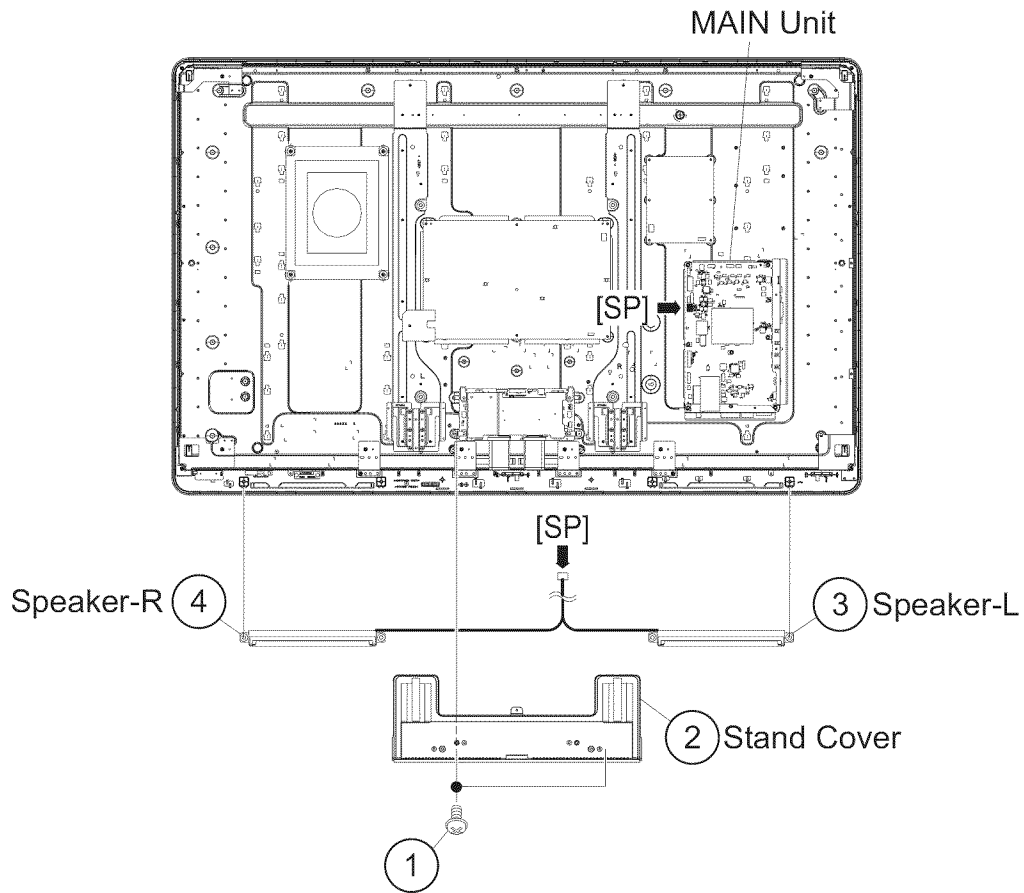

### 3. Removing of Connectors

1. Disconnect the following connectors from the MAIN Unit. (SB, LB, RA, RL)
2. Disconnect the following connectors from the POWER/LED Drive Unit. (LA, PD, PL)
3. Disconnect the following connectors from the LCD Control Unit. (LW, PL)

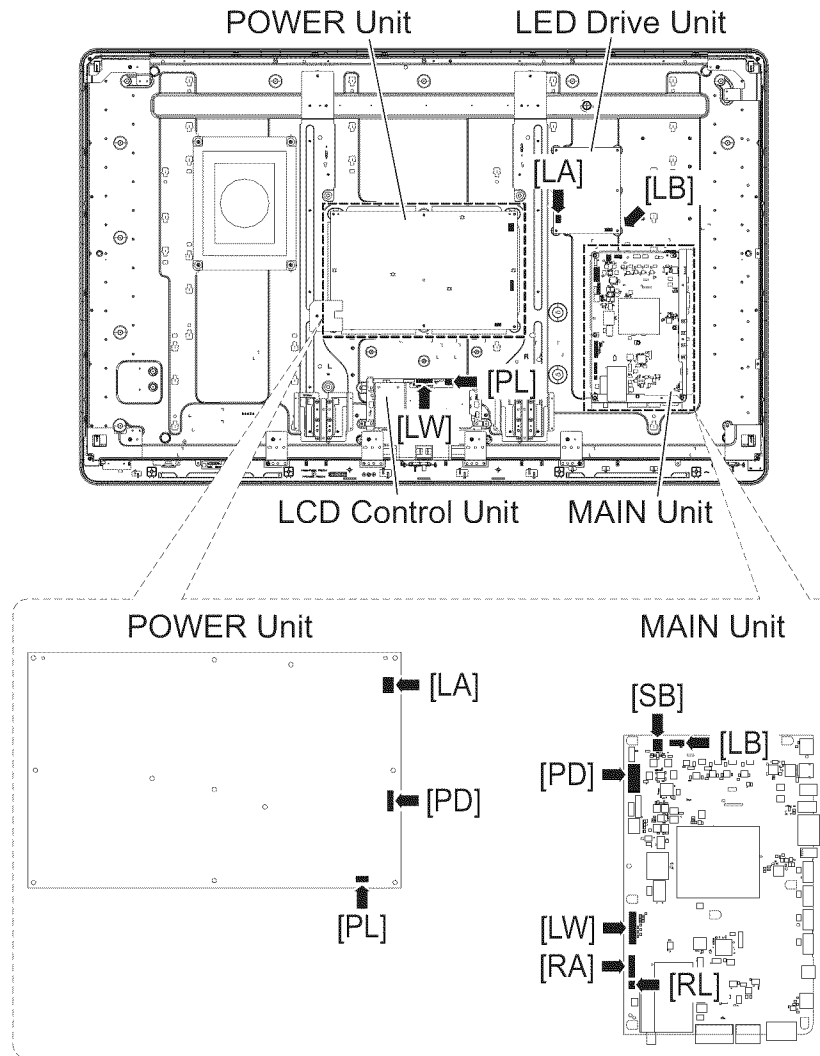

**4. Removing of MAIN Unit, POWER Unit, Woofer, Stand Angle,60" LCD Panel Module Unit.**

1. Remove the 7 lock screws ① and detach the MAIN Unit ②.
2. Remove the 2 lock screws ③ and detach the Terminal Cover (Bottom) ④.
3. Remove the 2 lock screws ⑤ and detach the Terminal Cover (Side) ⑥.
4. Remove the 6 lock screws ⑦ and detach the POWER Unit ⑧.
5. Remove the 4 lock screws ⑨ and detach the Sub Woofer ⑩.
6. Remove the 1 lock screw ⑪ and detach the LCD Fixing Angle (Bottom-R) ⑫.
7. Remove the 2 lock screws ⑬ and detach the LCD Fixing Angle (Top-L) ⑭.
8. Remove the 2 lock screws ⑮ and detach the LCD Fixing Angle (Top-R) ⑯.
9. Remove the 2 lock screws ⑰ and detach the LCD Fixing Angle (Bottom-L) ⑱.
10. Remove the 4 lock screws ⑲ 2 lock screws ⑳ and detach the 2 LCD Fixing Angle (B-MA) ㉑ and 2 Fixing Angle (B-M2) ㉒.
11. Remove the 12 lock screws ㉓ and detach the 2 Stand Angle ㉔.
12. Remove the 3 lock screws ㉕ and detach the BL Support Angle ㉖.
13. Remove the 11 lock screws ㉗ and detach the 60" LCD Panel Module Unit ㉘.

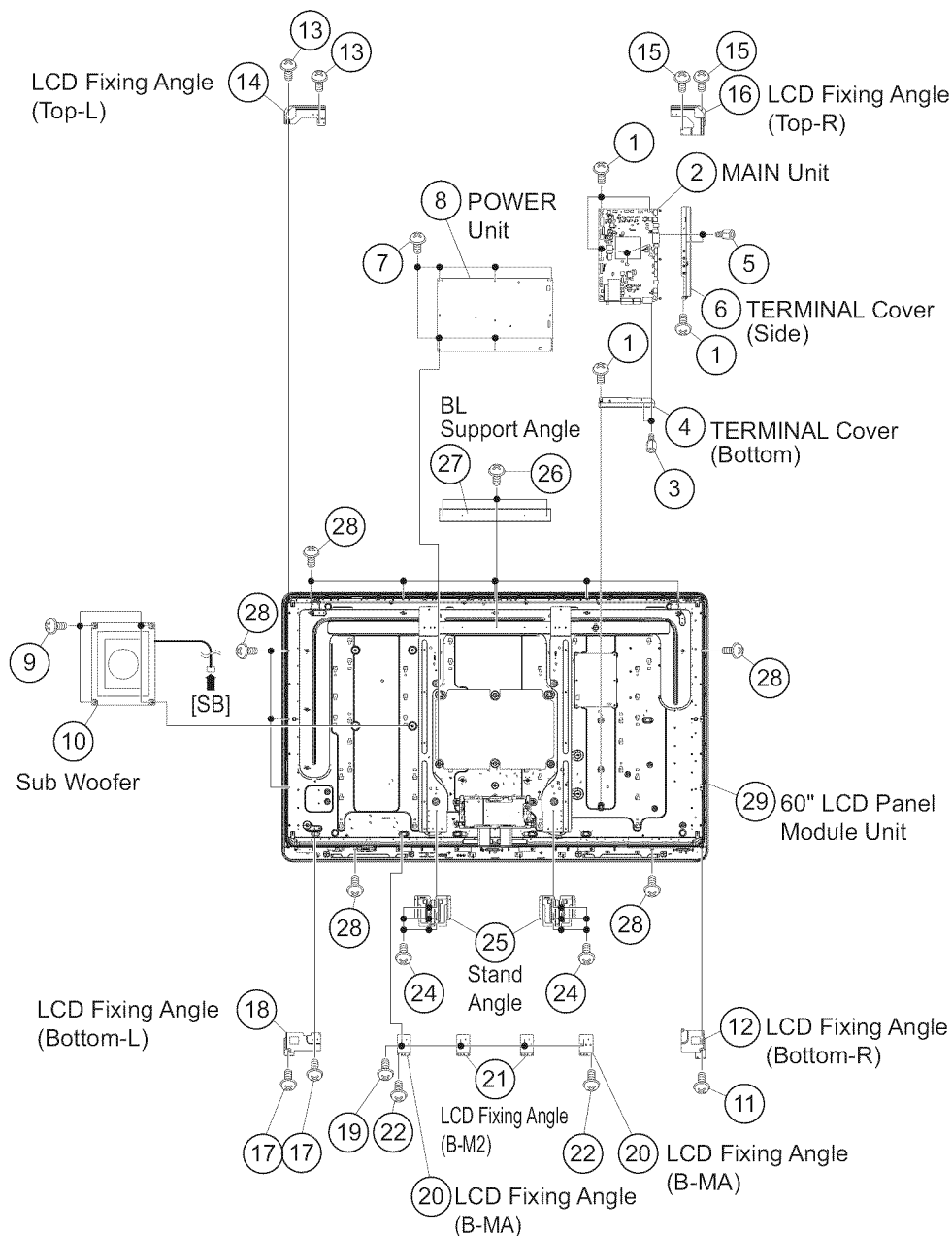

## 5. Removing of R/C, LED Unit, ICON Unit, LOGO Unit, Front Cabinet Ass'y, Glass Front Panel Ass'y, TOUCH SENSOR Unit.

1. Detach the R/C, LED Unit ①.
2. Detach the ICON Unit ②.
3. Detach the LOGO Unit ③.
4. Remove the 28 Hooks ④ and detach the Front Cabinet Ass'y ⑤.
5. Detach the Glass Front Panel Ass'y ⑥.
6. Detach the Touch Sensor Unit ⑦.

NOTE: The Touch Sensor unit ⑦ removed once is not reusable.

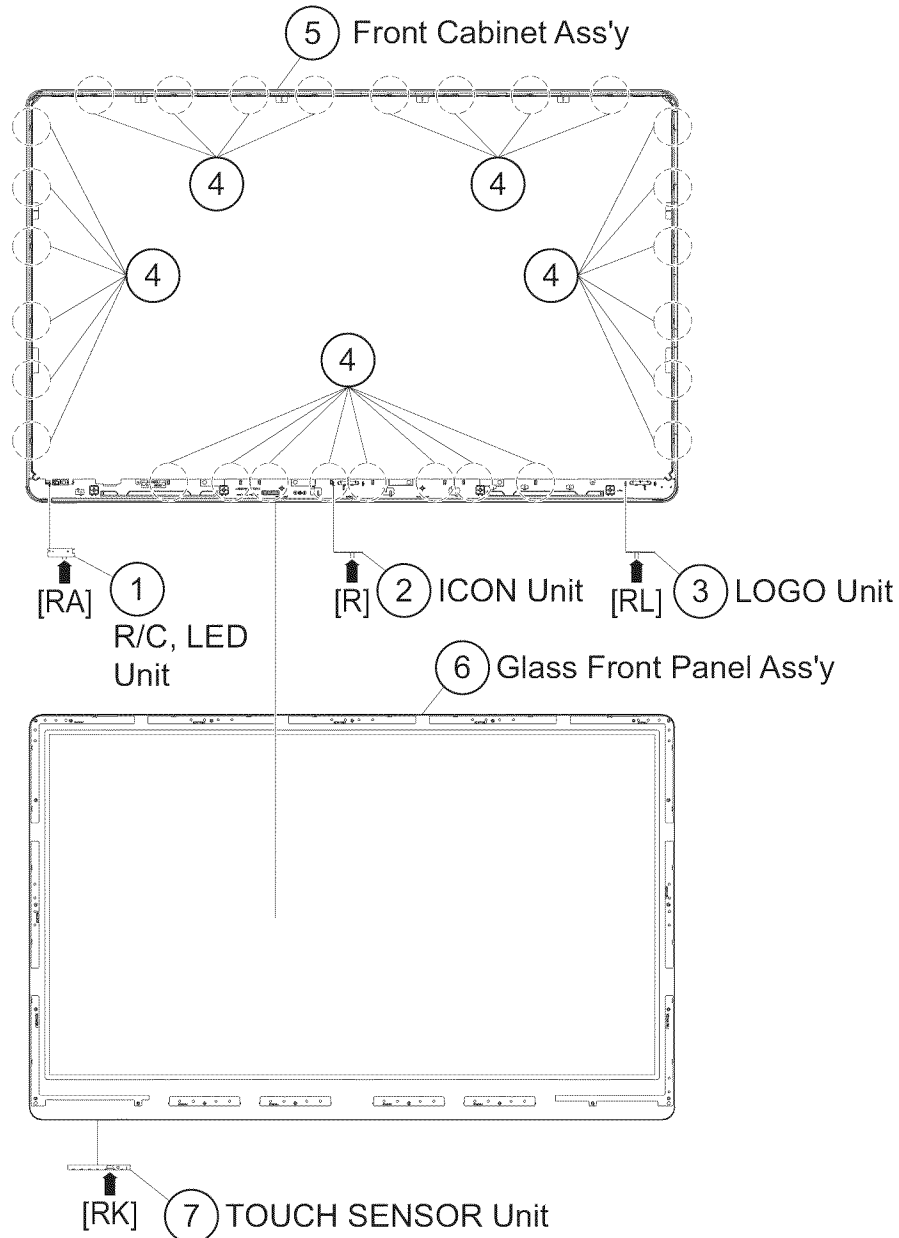

### [3] Caution Cleaning Glass

#### 1. Glass handling

CAUTION: (1) As for handling, wear clean gloves, protective footwear and mask.

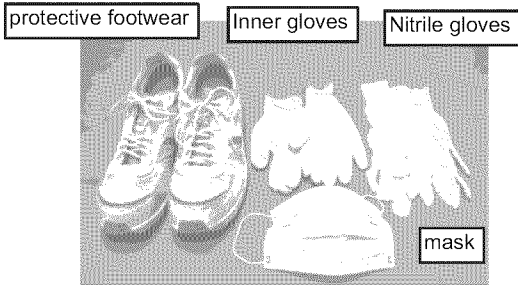

(2) Inner gloves are covered in the Nitrile gloves.

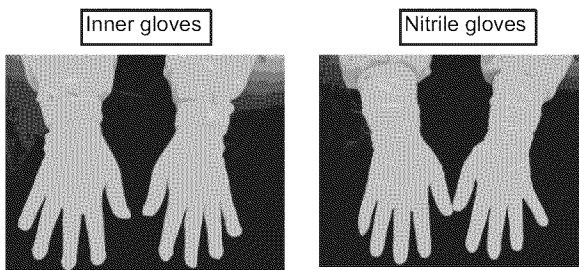

(3) Nitrile gloves are exchanged with the following standard.

- When it touched a face and so on.
- When another work was done.
- By the work of fifty times.
- In the time for recess.
- When it became dirty.
- When it tore.



(4) It has a black mask part.  
You must not have a clear surface.



(5) Two people have handling equally by the work.  
(Maintain it so that glass is not warped.)



(6) When it is put horizontally, it is put on the flat mat.

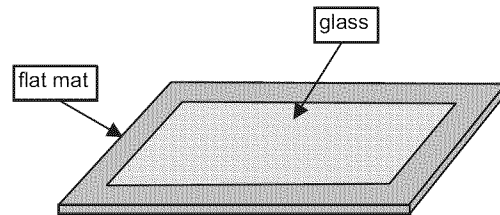

(7) A cushion material is put between glass.  
It doesn't touch it [the front and the front].  
It can be put to two glass.

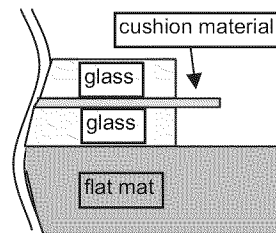

(8) It has a module part before the CAB-B installation.  
(It has a module part.)

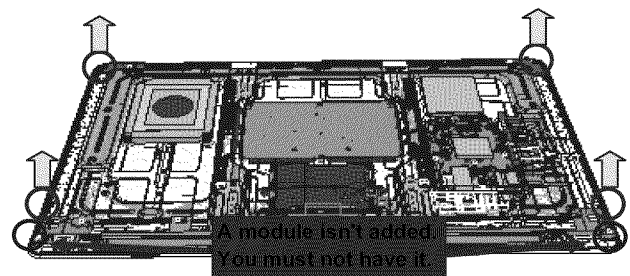

## 2. Glass cleaning

CAUTION: (1) Visual inspection is done on the black mat.

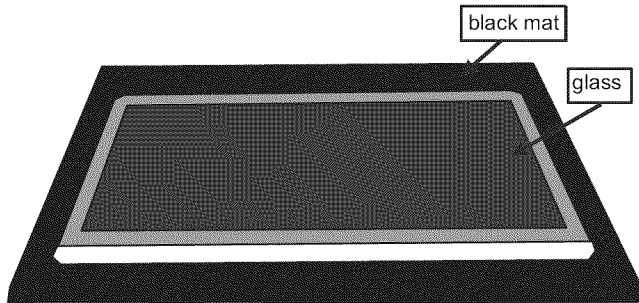

(2) Dust and trash are taken with an air blow.

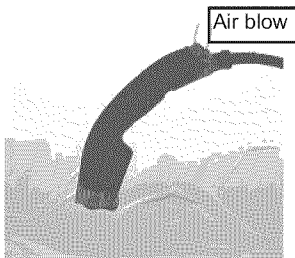

(3) Dirt is wiped out with cloth.

Front side: Moufas

Back side: Cotton (clean wiper SF-30C)

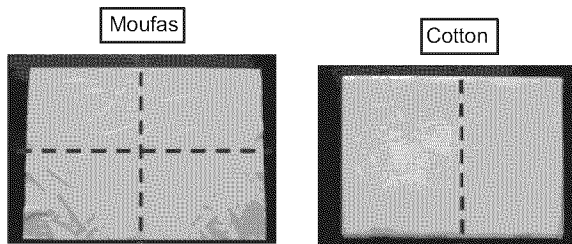

(4) When dirt doesn't clean, it is wiped out with Alcohol.

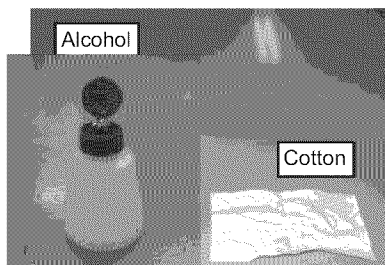

(5) Dirt is wiped out with the Ethanol and clean cloth.

When wipe off a dirt the trace which wiped do not be left.

### [4] How to replace the touch key sensor PWB

1. Replace the touch key sensor PWB in a clean room.  
Be sure to remove the dust from the unit before carrying it into the clean room.
2. Remove the touch key sensor PWB from the front glass.
3. Clean the bonding surface with alcohol.  
Depending on the dirt, water solution of 80%vol can be effective.
4. Adhere a spacer before bonding the touch unit.  
Product Manual Touch Sensor with ITO (Transparent Electrode)

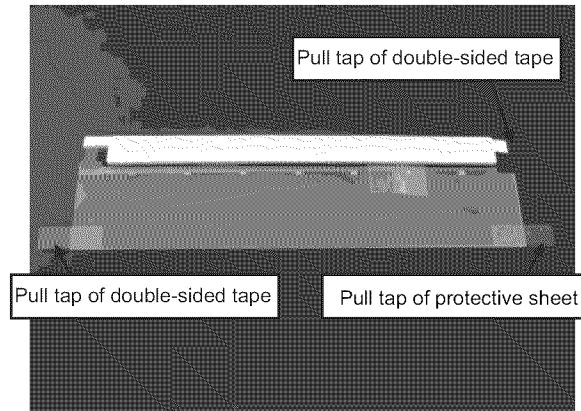
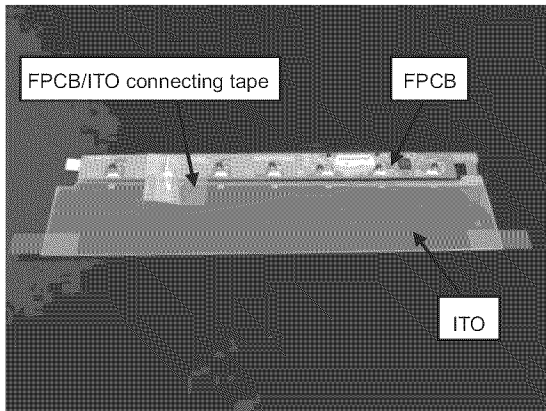

- i) Remove the touch sensor from the front glass.

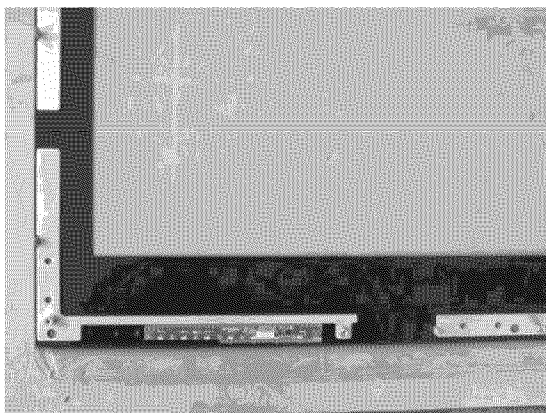

\* When peeling the ITO section, check that there is no glue residue on the front glass.  
If glue residue, dirt, fingerprints, etc. are found, wipe them off with anhydrous alcohol.  
Do not apply anhydrous alcohol to the double-sided tape on the metal part attaching to the glass.

- ii) Adhere the spacer to the back of the FPCB section.

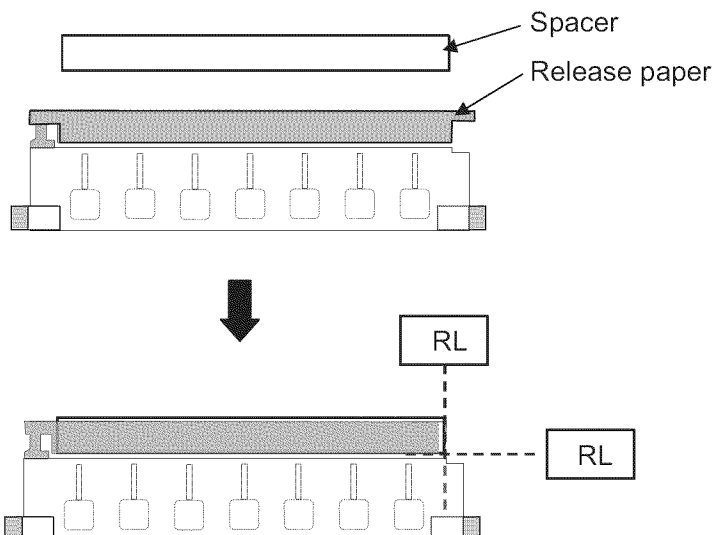

- ii-1. Peel the release paper of the double-sided tape on the FPCB section.
- ii-2. Adhere the spacer to the FPCB section.  
(Use the right and upper sides of the FPCB section as a reference.)

\* Check that the spacer does not contact with the ITO section.



iii) Adhere the ITO section to the front glass. (Use the positioning jig.)

Tape fixing the FPCB and ITO sections (Adhered by the supplier)

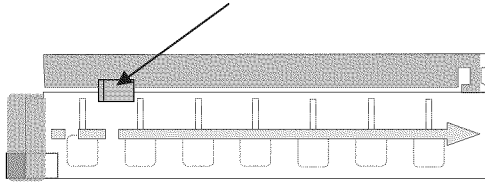

iii-1. Peel the release paper of the double-sided tape on the ITO section.

iii-2. Slowly adhere it from the end using a roller. (Position the touch sensor using the jig.)

\* Check that there are no bubbles in the ITO section after adhered.

\* Adhering error:  $\pm 1.0\text{mm}$

iv) Adhere the FPCB section to the front glass.

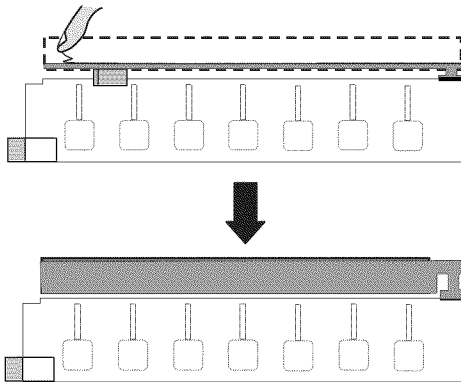

iv-1. Lift the FPCB section to peel the release paper of the double-sided tape on the spacer.

\* Be careful not to apply stress to the joint of FPCB and ITO.

iv-2. Adhere the FPCB section to the front glass.

\* Be careful not to apply stress to the joint of FPCB and ITO.

iv-3. Peel the tape fixing the FPCB and ITO sections.

5. Attach the touch unit bonding procedure.

It includes peeling of the protective sheet.

How to mount the touch sensor

i) Adhere after positioned using the positioning jig.

ii) Peel the protective sheet by means of the pull tap for peeling the protective sheet.

iii) Adhere the FPCB to the glass. (Do not warp the FPCB if possible.)

Pull tap for peeling the protective sheet of the double-sided tape in the FPCB section.

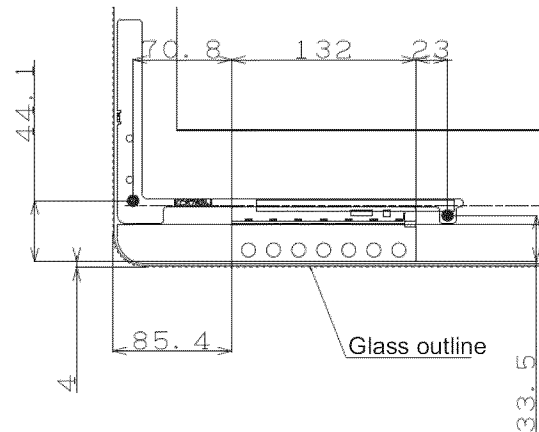
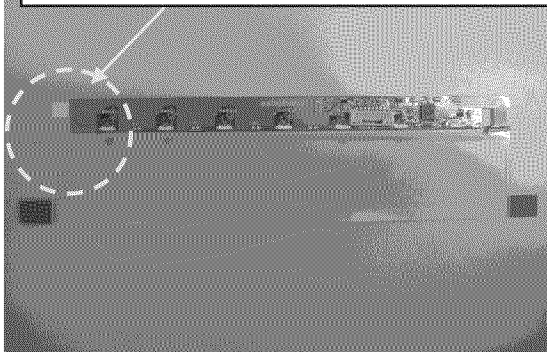

## LC-52LE920UN/LC-60LE920UN

- iv) Peel the protective sheet of the OCA.

Lift the ITO section, then peel the protective sheet by about half by means of the pull tap.

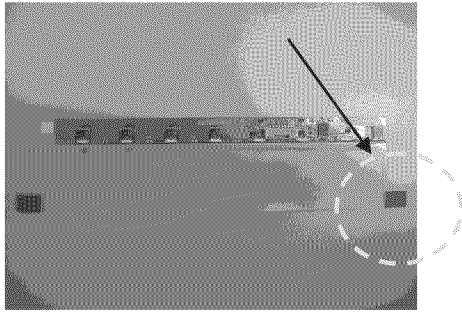

\* Peeling it completely reduces workability.  
Check the order due to workability.

- v) Contact the FPCB and joint end of the transparent electrode film with the glass.

\* Grasp the opposite end. Note that the ITO is positioned by adhering.

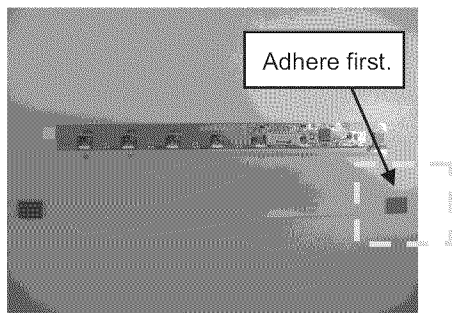

\*Note: Do not bend the PWB (FPCB section)  
and sheet (ITO section).

- vi) Adhere the transparent electrode completely.

Peel the front protective sheet.

If bubbles are found, press those portions with glass  
cleaning cloth, etc. to remove them as much as possible.

Pull tap for peeling the front protective sheet



- Use a rubber roller since pressure exerted by it removes bubbles easily. See photo below.

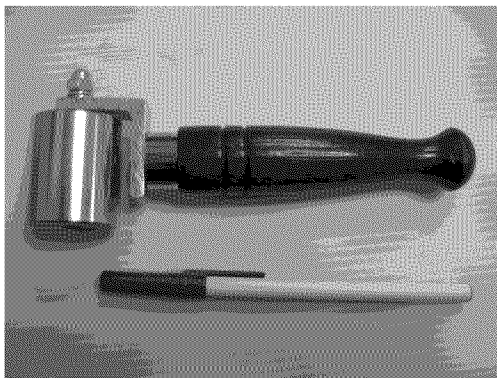

- For the TOUCH SENSOR Unit positioning figure, see page 5-1, 5-2, 5-3, 5-4.

## CHAPTER 5. ADJUSTMENT

### [1] ADJUSTMENT PROCEDURE

The adjustment values are set to the optimum conditions at the factory before shipping. If a value should become improper or an adjustment is required due to part replacement, make an adjustment according to the following procedure.

#### 1. After replacement of any PWB unit and/or IC for repair, please note the following.

- When replacing the following units, make sure to prepare the new units loaded with updated software.

MAIN Unit: DKEYMF452FM20

- When replacing the LCD control PWB, perform the VCOM adjustment.

#### 2. Upgrading of each microprocessor software

CAUTION: Never "POWER OFF" the unit when software upgrade is ongoing.

Otherwise the system may be damaged beyond recovery.

##### 2.1. Software version upgrade

The model employs the following software.

- Main software (please use a software version after HLI2Bxxx.USB).
- Monitor microprocessor software (please use a software version after HLI2Bxxx.USB and HLNIMxxx.BIN.)

The main software, monitor microprocessor software can be upgraded by using a general-purpose USB Memory.

The followings are the procedures for upgrading, explained separately for the main software, monitor microprocessor software.

##### 2.2. Main software version upgrade

###### 2.2.1 Get ready before you start

- USB Memory of 128MB or higher capacity.
- PC running on Windows 98/98SE/ME/2000/XP operating system.
- USB Memory reader/writer or PC with a USB port.
- The file system of a USB memory is FAT. (FAT32 supports)
- Use the USB memory without other functions. (lock and memory reader...etc)

###### 2.2.2 Preparations

To upgrade the main software, it is necessary to get ready the USB Memory for version upgrade before you start.

Follow the steps below and create the USB Memory for version upgrade.

1. Copy the file HLI2Bxxx.USB for version upgrade to the root directory (folder) of the USB Memory.

NOTE: In the USB Memory drive, do not store other folders or unrelated files, or more than one file for version upgrade.

Now the USB Memory for version upgrade is ready.

**2.2.3 How to upgrade the software**

1. Plug AC cord and turn on the TV.
  2. After picture displayed, touch the power key for 5seconds.
- NOTE: Picture will disappear when you touch the power key, but keep touching it.

3. When the center icon LED blinks, release your finger from the power key.
4. Next, touch the "POWER" and "CH ( ^ )" keys at the same time.
5. When the center icon LED turns on, release your finger form the keys.
6. After the unit startup, the system upgrade screen as shown below within 20-40 seconds.

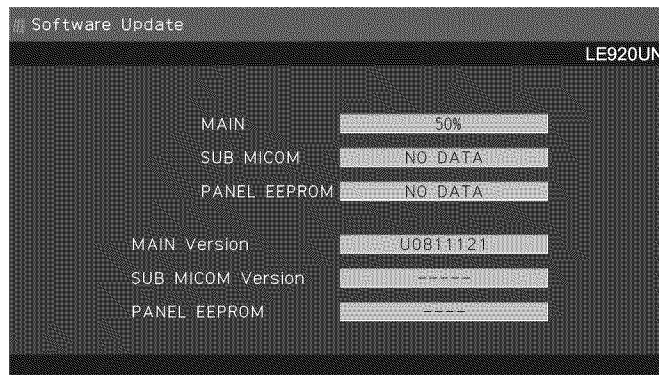

7. Even a single failure in the process will trigger the upgrade failure screen.

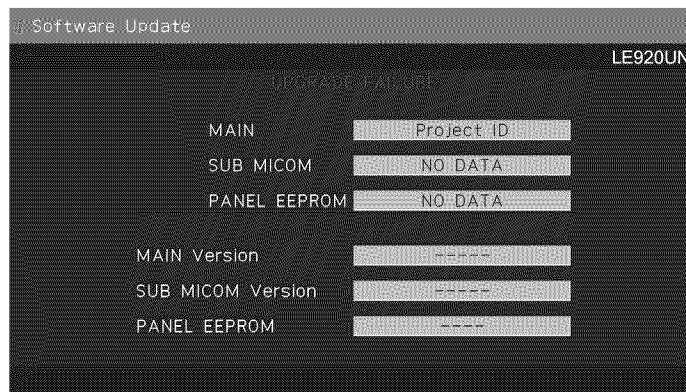

NOTE: In the event of a failure, repeat the upgrade process. If the process repeatedly fails, it is likely that the hardware need fixing.

8. Upon completion of the whole process, the upgrade success screen as shown below appears. You can check the new software version on this screen. The version information appears after the upgrade is complete.

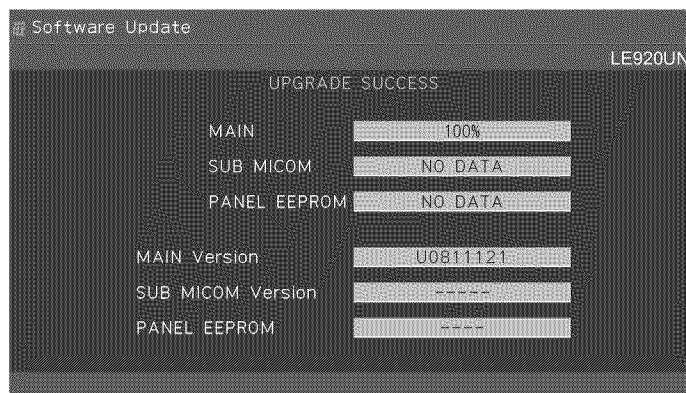

9. Unplug the AC cord and remove the USB Memory for version upgrade.
10. Now the software version upgrade is complete.

NOTE: When you are done with the software version upgrade, start the set, go to the top page of the adjustment process screen and check the main software version information.

### 2.3. Monitor microprocessor software version upgrade

Create the USB memory for monitor microprocessor software version upgrade in the same manner as explained in the "Main software version upgrade".

Copy the file HLI2Bxxx.USB and HLNIMxxx.BIN (named temporarily) for monitor microprocessor software version upgrade to the USB memory.

#### 2.3.1 How to upgrade the software

1. Plug AC cord and turn on the TV.
  2. After picture displayed, touch the power key for 5seconds.
- NOTE: Picture will disappear when you touch the power key, but keep touching it.
3. When the center icon LED blinks, release your finger from the power key.
  4. Next, touch the "POWER" key with the "CH (∧)" key touching.
  5. When the center icon LED turns on, release your finger from the keys.

CAUTION: • The moment this operation is done, the upgrading of the monitor microprocessor software starts. While the upgrade is ongoing, never power off the unit. Otherwise the upgrade will fail and the system may be serious damaged beyond recovery (inability to start).

- After the monitor microprocessor software is upgraded, also perform the 'Industry Init'.

6. After the unit startup, the upgrade starts. The power led will blink continuously. Also, an upgrade screen will be shown during a minor upgrade.

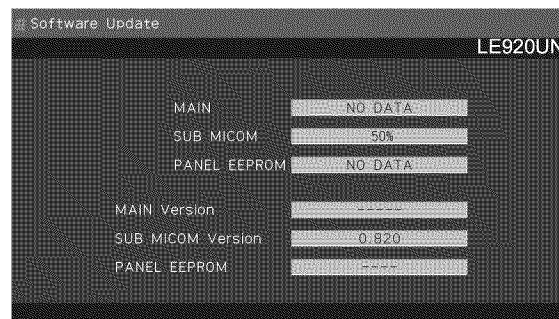

7. If the upgrade fails, power led will stop blinking. Also, the upgrade failure screen will be shown if upgrade screen was shown at 5.

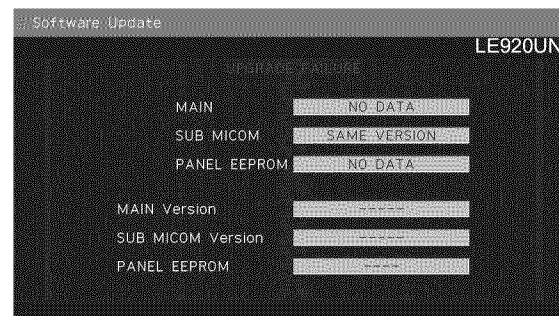

NOTE: In the event of a transient failure, upgrade will be automatically retried up to three times. If the process repeatedly fails, hardware may be the cause.

8. The upgrade success screen will be shown if upgrade screen was shown at 5.

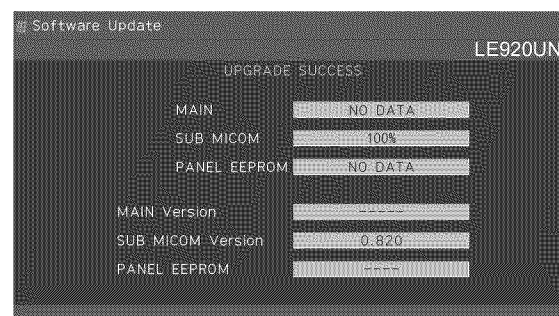

9. Unplug the AC cord and remove the USB Memory for version upgrade.

10. Now the software version upgrade is complete.

NOTE: When you are done with the software version upgrade, start the set, go to the top page of the adjustment process screen and check the monitor microprocessor software version information and panel size information.

### 3. Entering and exiting the adjustment process mode

- 1) Before entering the adjustment process mode, the AV position RESET in the video adjustment menu.
- 2) At the state TV is turned on, touch the power key for 5seconds.  
NOTE: Picture will disappear when you touch the power key, but keep touching the power key.
- 3) When the center icon LED blinks, release your finger from the power key.
- 4) Next, touch the "POWER" key with the "VOL (—)" and "INPUT" key touching.  
TV will turn on and the letter "<K>" appears on the screen.
- 5) Next, touch the "VOL (—)" and "CH (∨)" keys at the same time.
- 6) When the center icon LED turns on, release your finger form the keys.

(The "VOL (—)" and "CH (∨)" keys should be pressed and held until the display appears.)

Multiple lines of blue characters appearing on the display indicate that the unit is now in the adjustment process mode.

When you fail to enter the adjustment process mode (the display is the same as normal startup), retry the procedure.

- 7) To exit the adjustment process mode after the adjustment is done, unplug the AC cord from the outlet to make a forced shutdown. (When the power was turned off with the remote controller, once unplug the AC cord and plug it again. In this case, wait 10 seconds or so before plugging.)

CAUTION: Use due care in handling the information described here lest your users should know how to enter the adjustment process mode. If the settings are tampered in this mode, unrecoverable system damage may result.

### 4. Remote controller key operation and description of display in adjustment process mode

- 1) Key operation

Remote controller key	Main unit key	Function
CH (∨ / ∧)	CH (∨ / ∧)	Moving an item (line) by one (UP/DOWN)
VOL (+/-)	VOL (+/-)	Changing a selected item setting (+1/ -1)
Cursor (UP/DOWN)	—————	Turing a page (PREVIOUS/NEXT)
Cursor (LEFT/RIGHT)	—————	Changing a selected line setting (+10/ -10)
INPUT	—————	Input switching (toggle switching)
ENTER	—————	Executing a function

\*Input mode is switched automatically when relevant adjustment is started so far as the necessary input signal is available.

- 2) Description of display

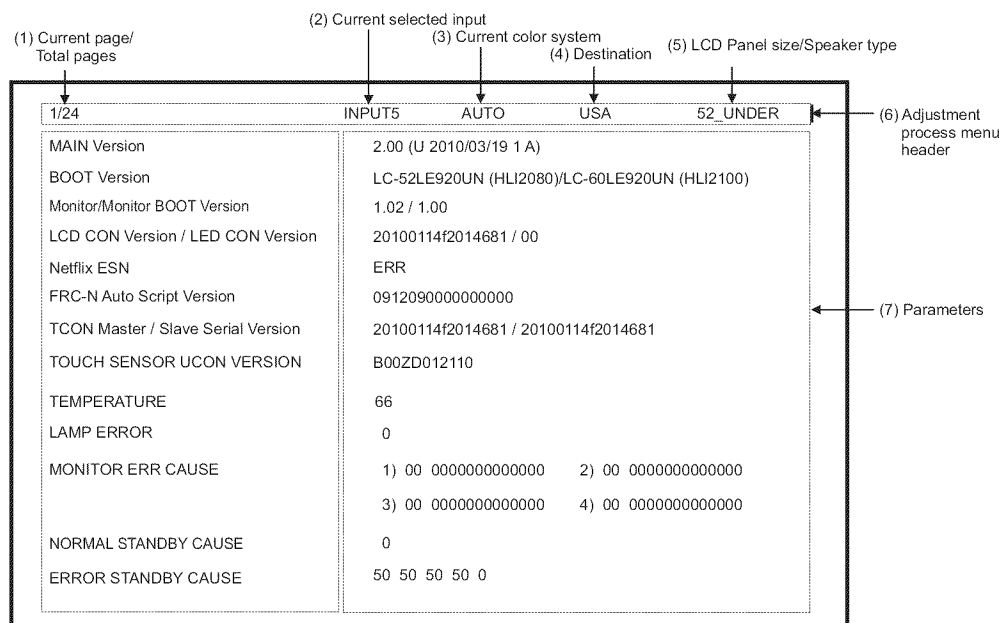

## 5. List of adjustment process mode menu

The character string in brackets [ ] will appear as a page title in the adjustment process menu header.

Page	Line	Item	Description	Remarks (adjustment detail, etc.)
1	1	MAIN Version	Main software version	Versions are always '090626000T0001'.  Refer to *1 under the list for details Refer to *2 under the list for details
	2	BOOT Version		
	3	Monitor/Monitor BOOT Version	Monitor and monitor boot software version	
	4	LCD CON Version / LED CON Version	LCD controller software version	
	5	Netflix ESN		
	6	FRC-N Auto Script Version	Audio data checksum	
	7	TCON Master/Slave Serial Version		
	8	TOUCH SENSOR UCON VERSION		
	9	TEMPERATURE	Panel temperature	
	10	LAMP ERROR	Number of termination due to lamp error	
	11	MONITOR ERR CAUSE		
	12	NORMAL STANDBY CAUSE		
	13	ERROR STANDBY CAUSE		
2	1	INDUSTRY INIT	Initialization to factory settings	Level appears in green on the upper right
	2	INDUSTRY INIT(-Public)		
	3	PUBLIC MODE	Public mode	
	4	Center Acutime	Accumulated main operation time	
	5	RESET	Reset	
	6	Backlight Acutime	Accumulated monitor operation time	
	7	RESET	Reset	
	8	LAMP ERROR RESET	Reset LAMP ERROR	
	9	VIC XPOS	X-coordinate setting for VIC READ	
	10	VIC YPOS	Y-coordinate setting for VIC READ	
	11	VIC COLOR	Collected color data setting for VIC READ	
	12	VIC SIGNAL TYPE	Signal type setting for VIC READ	
	13	VIC READ	Picture level acquisition function	
3	1	N358 ALL ADJ(INPUT2)	CVBS and TUNER signal level adjustment	
	2	N358 MAIN ADJ(INPUT2)	CVBS signal level adjustment	
	3	TUNER DAC ADJ	TUNER signal level adjustment	
	4	N358 CONTRAST A_GAIN		
	5	N358 CONTRAST D_GAIN		
	6	N358 CONTRAST OFFSET		
	7	TUNER CONTRAST A_GAIN		
	8	TUNER CONTRAST D_GAIN		
	9	TUNER CONTRAST OFFSET		
4	1	TUNER VCHIP TEST(69ch)	Tuning test and VCHIP test (69ch)	
	2	TUNER VCHIP TEST(7ch)	Tuning test and VCHIP test (7ch)	
	3	TUNER VCHIP TEST(10ch)	Tuning test and VCHIP test (10ch)	
	4	TUNER VCHIP TEST(15ch)	Tuning test and VCHIP test (15ch)	
	5	INSPECT USB TERM		
	6	HDMI EDID WRITE		
	7	HDMI CEC TEST		
5	1	COMP15K ADJ(INPUT1)	Component 15K picture level adjustment (main)	
	2	COMP15K Y A_GAIN		
	3	COMP15K Cb A_GAIN		
	4	COMP15K Cr A_GAIN		
	5	COMP15K Y OFFSET		
	6	COMP15K Cb OFFSET		
	7	COMP15K Cr OFFSET		
6	1	COMP33K ADJ(INPUT1)	Component 33K picture level adjustment (main)	
	2	COMP33K Y A_GAIN		
	3	COMP33K Cb A_GAIN		
	4	COMP33K Cr A_GAIN		
	5	COMP33K Y OFFSET		
	6	COMP33K Cb OFFSET		
	7	COMP33K Cr OFFSET		

Page	Line	Item	Description	Remarks (adjustment detail, etc.)
7	1	ANALOG RGB ADJ	Analog RGB picture level adjustment	
	2	R A_GAIN		
	3	G A_GAIN		
	4	B A_GAIN		
	5	R OFFSET		
	6	G OFFSET		
	7	B OFFSET		
8	1	VCOM ADJ	VCOM adjustment value	
9	1	LEV1	Standard value 1	Adjustment gradation setting.
	2	LEV2	Standard value 2	
	3	LEV3	Standard value 3	
	4	LEV4	Standard value 4	
	5	LEV5	Standard value 5	
	6	LEV6	Standard value 6	
10	1	MG1R	WB adjustment Point 1, R adjustment value	Parameter for six-point adjustment
	2	MG1G	WB adjustment Point 1, G adjustment value	
	3	MG1B	WB adjustment Point 1, B adjustment value	
	4	MG1Y	WB adjustment Point 1, Y adjustment value	
	5	MG2R	WB adjustment Point 2, R adjustment value	
	6	MG2G	WB adjustment Point 2, G adjustment value	
	7	MG2B	WB adjustment Point 2, B adjustment value	
	8	MG2Y	WB adjustment Point 2, Y adjustment value	
	9	MG3R	WB adjustment Point 3, R adjustment value	
	10	MG3G	WB adjustment Point 3, G adjustment value	
	11	MG3B	WB adjustment Point 3, B adjustment value	
	12	MG3Y	WB adjustment Point 3, Y adjustment value	
11	1	MG4R	WB adjustment Point 4, R adjustment value	Parameter for six-point adjustment
	2	MG4G	WB adjustment Point 4, G adjustment value	
	3	MG4B	WB adjustment Point 4, B adjustment value	
	4	MG4Y	WB adjustment Point 4, Y adjustment value	
	5	MG5R	WB adjustment Point 5, R adjustment value	
	6	MG5G	WB adjustment Point 5, G adjustment value	
	7	MG5B	WB adjustment Point 5, B adjustment value	
	8	MG5Y	WB adjustment Point 5, Y adjustment value	
	9	MG6R	WB adjustment Point 6, R adjustment value	
	10	MG6G	WB adjustment Point 6, G adjustment value	
	11	MG6B	WB adjustment Point 6, B adjustment value	
	12	MG6Y	WB adjustment Point 6, Y adjustment value	
	13	MG6Y OFFSET		
12	1	MODE SELECT		
	2	POS SELECT		
	3	POS MIN		
	4	POS MID1		
	5	POS MID2		
	6	POS MID3		
	7	POS MID4		
	8	POS MID5		
	9	POS MID6		
	10	POS MAX		
13	1	CD MIN		
	2	CD MID1		
	3	CD MID2		
	4	CD MID3		
	5	CD MID4		
	6	CD MID5		
	7	CD MID6		
	8	CD MAX		



Page	Line	Item	Description	Remarks (adjustment detail, etc.)
14	1 2 3 4 5 6 7 8	CALC RESET VAL1 VAL2 VAL3 VAL4 VAL5 VAL6		
15	1 2 3	MONITOR TIME OUT MONITOR MAX TEMP MONITOR ERROR CAUSE RESET		
16	1 2 3 4 5 6 7	LCD TEST PATTERN LCD TEST PATTERN1 LCD TEST PATTERN2 LCD TEST PATTERN3 LCD TEST PATTERN4 TV TEST PATTERN 1 TV TEST PATTERN 2		
17	1 2 3 4 5 6 7	FRC-N Firmware Version FRC-N Boot Script Version FRC-N Device Version TCON FPGA1 Serial Flash Version TCON FPGA2 Serial Flash Version TCON FPGA1 Config Rom Version TCON FPGA2 Config Rom Version		
18	1 2 3 4 5 6 7 8	READ/WRITE SLAVE ADDRESS RESISTER ADDRESS UPPER RESISTER ADDRESS LOWER WRITE DATA UPPER WRITE DATA LOWER READ DATA UPPER READ DATA LOWER		
19	1 2 3 4 5 6 7 8 9 10	POWER LED BRIGHTNESS MENU LED BRIGHTNESS INPUT LED BRIGHTNESS CH UP LED BRIGHTNESS CH DOWN LED BRIGHTNESS VOL UP LED BRIGHTNESS VOL DOWN LED BRIGHTNESS LOGO LED BRIGHTNESS ICON LED BRIGHTNESS ICON LED BRIGHTNESS (STANDBY)		
20	1 2 3 4 5 6 7	POWER KEY SENSITIVITY MENU KEY SENSITIVITY INPUT KEY SENSITIVITY CH UP KEY SENSITIVITY CH DOWN KEY SENSITIVITY VOL UP KEY SENSITIVITY VOL DOWN KEY SENSITIVITY		
21	1 2 3 4 5 6 7 8	KEY STRENGTH GET MODE POWER KEY STRENGTH MENU KEY STRENGTH INPUT KEY STRENGTH CH UP KEY STRENGTH CH DOWN KEY STRENGTH VOL UP KEY STRENGTH VOL DOWN KEY STRENGTH		
22	1 2 3 4 5 6	KEY LOCK (1217) KOUTEI AREA ALL CLEAR A MODE AREA CLEAR BACKUP AREA CLEAR B MODE AREA CLEAR EXECUTION		

Page	Line	Item	Description	Remarks (adjustment detail, etc.)
23	1	ERROR STANDBY CAUSE1		
	2	ERROR STANDBY CAUSE2		
	3	ERROR STANDBY CAUSE3		
	4	ERROR STANDBY CAUSE4		
	5	ERROR STANDBY CAUSE5		
	6	ERROR STANDBY CAUSE RESET		
24	1	EEP SAVE	Writing setting values to EEPROM	
	2	EEP RECOVER	Reading setting values from EEPROM	
	3	MODEL NAME		
	4	PANEL SIZE		
	5	SETTING FOR ADJ		
	6	PANEL LIMIT		
	7	PANEL RANGE LIMIT		
	8	SHORT CHECK MODE		
	9	SHORT CHECK CURRENT		
	10	CURRENT SW		

**\*1 Details of P1.9 (NORMAL STANDBY CAUSE)**

- |   |                            |                                      |
|---|----------------------------|--------------------------------------|
| 2 | No operation off           | in the cause of "no operation off"   |
| 3 | No signal off              | in the cause of "no signal off"      |
| 4 | PC power management mode 1 | in the cause of "Standby mode MODE1" |
| 5 | PC power management mode 2 | in the cause of "Standby mode MODE2" |
| 6 | Off timer                  | in the cause of "SLEEP timer"        |
| 8 | Command from RS232C        | in the cause of command by RS-232C   |

**\*2 Details of P1.10 (ERROR STANDBY CAUSE)**

- |    |   |  |
|----|---|--|
| 11 | Prolonged unspecified-signal input in PC mode | in the cause of continuous "out of range", PC input mode |
| 17 | Temperature error                             | in the cause of abnormal temperature                     |
| 1A | Monitor trouble detected                      | in the cause of abnormal monitor mode                    |
| 22 | LCD controller Rom error                      | in the cause of software abnormality of LCD controller   |

**6. Special features**

\* STANDBY CAUSE (Page 1/24)

Display of a cause (code) of the last standby

The cause of the last standby is recorded in EEPROM whenever possible.

Checking this code will be useful in finding a problem when you repair the troubled set.

\* EEP SAVE (Page 24/24)

Storage of EEP adjustment value

\* EEP RECOVER (Page 24/24)

Retrieval of EEP adjustment value from storage area

## 7. Microprocessor software writing

### 7.1. Main microprocessor/monitor microprocessor software writing (Main PWB: QPWBF452WJZZ)

	Adjustment item	Adjustment conditions	Adjustment procedure
1	Main microprocessor/monitor microprocessor software writing <Main PWB>	Software Version Up  File version check USB memory check   * When IC is failure	1. Insert a USB memory for the main/monitor microprocessor into the service connector. 2. Supply AC power and write the main software to IC8401 and the monitor microprocessor software to IC2002. 3. Check that writing is normally completed and turn off the power.  CAUTION: When the USB memory is not inserted or reading error occurs, nothing is written. (The former models have read the main software from the writing jig. However, this model reads the main/monitor software from the USB memory.)  Please exchange to another PWB unit when IC8401 (NAND Flash) is failure. (Because the software can't be written with USB memory, when the new IC is exchanged from broken IC)

### 7.2. Model/inch discrimination writing (Main PWB: QPWBF452WJZZ)

- When writing the sub microprocessor software, the model data is configured with the software from the USB memory mounted to the checker.
- Reference and setting change are enabled through the process menu and RS-232C communication.

## 8. Signal adjustment

### 8.1. LCD section adjustment [LCD module adjustment]

	Adjustment item	Adjustment conditions	Adjustment procedure
1	Opposite bias adjustment (LCD module adjustment item)	Adjustment in the center position of the panel	1. Enter the process mode using the process adjustment remote control. 2. Select [VCOM ADJ] using the Channel $\wedge/\vee$ keys on the remote control. 3. Press the Enter key to check that the pattern for adjustment is displayed. 4. Make adjustment so that the flicker located in the center of the screen is minimized using the Volume +/- keys on the remote control. 5. If the optimum condition is obtained in step 4, press the Enter key to turn off the pattern.  CAUTION: * Make adjustment with no ANT signal (since the brightness is changed by the active backlight). [Adjustment position]

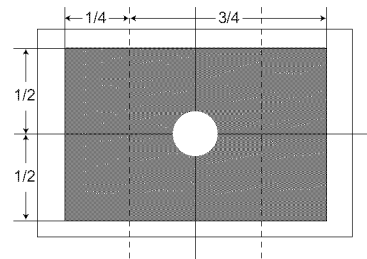

### 8.2. Image adjustment

#### 8.2.1 Device check

■ Before adjustment, check that the adjustment jig and signal source are set for Sharp LCD US.

Signal adjustment works at only the default View Mode.

Before adjustment, confirm the View Mode is set as follows.

Adjustment Type	Default View Mode
Composite/Tuner	S.Stretch
Comp15k	S.Stretch
Comp33k	Stretch
Analog RGB	Stretch

## LC-52LE920UN/LC-60LE920UN

### ■ Signal generator level adjustment check (Adjust to the standard value level.)

- Composite signal: 0.714Vp-p ± 0.02Vp-p (Pedestal to white)
- 15K component signal: Y level: 0.714Vp-p ± 0.02Vp-p (Pedestal to white)  
PB/PR level: 0.7Vp-p ± 0.02Vp-p
- 33K component signal: Y level: 0.7Vp-p ± 0.02Vp-p (Pedestal to white)  
PB/PR level: 0.7Vp-p ± 0.02Vp-p
- Analog RGB: RGB level: 0.7Vp-p ± 0.02Vp-p (Pedestal to white)

### 8.2.2 Process mode

Adjustment point	Adjustment conditions	Adjustment procedure
Process mode		Enter the process adjustment mode using the process adjustment remote control.

### 8.2.3 Composite N358 signal/tuner adjustment

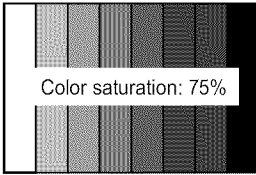
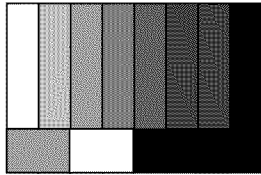
Adjustment point	Adjustment conditions	Adjustment procedure
1 Setting	N358 signal US-10ch	<ul style="list-style-type: none"> <li>• Send the N358 color bar (color saturation: 75%) signal to the Video 2 video input.</li> <li>• Send the in-house signal (use US-10ch) to TUNER.</li> </ul> <div style="display: flex; justify-content: space-around; align-items: center;"> <div style="text-align: center;"> <p>[Video input signal]</p>  <p>Color saturation: 75%</p> <p>↑ 100% white    ↑ 0% black</p> </div> <div style="text-align: center;"> <p>[In-house US-10ch]</p>  <p>↑ 100% white</p> </div> </div>
2 Automatic adjustment execution		Point the cursor to [■N358 ALL ADJ(INPUT2)] and press the [Enter] key. The adjustment is complete when [■N358 ALL ADJ(INPUT2) OK] is displayed.

### 8.2.4 Component 15K signal adjustment

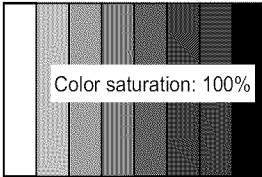
Adjustment point	Adjustment conditions	Adjustment procedure
1 Setting	480i signal	<ul style="list-style-type: none"> <li>• Send the 100% color bar signal to the Video 1 component input.</li> </ul> <div style="display: flex; justify-content: center; align-items: center;">  <div style="margin-left: 20px;"> <p>480i 100% color bar</p> </div> </div> <p style="text-align: center;">↑ 100% white    ↑ 0% black</p>
2 Automatic adjustment execution		Point the cursor to [■COMP15K ADJ(INPUT1)] and press the [Enter] key. The adjustment is complete when [■COMP15K ADJ(INPUT1) OK] is displayed.

### 8.2.5 COMPONENT 33K signal adjustment

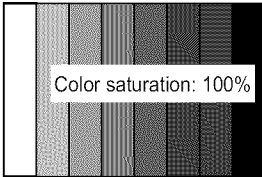
Adjustment point	Adjustment conditions	Adjustment procedure
1 Setting	1080i signal	<ul style="list-style-type: none"> <li>• Send the 100% color bar signal to the Video 1 component input.</li> </ul> <div style="display: flex; justify-content: center; align-items: center;">  <div style="margin-left: 20px;"> <p>1080i 100% color bar</p> </div> </div> <p style="text-align: center;">↑ 100% white    ↑ 0% black</p>
2 Automatic adjustment execution		Point the cursor to [■COMP33K ADJ(INPUT1)] and press the [Enter] key. The adjustment is complete when [■COMP33K ADJ(INPUT1) OK] is displayed.

## 8.2.6 Analog RGB signal adjustment

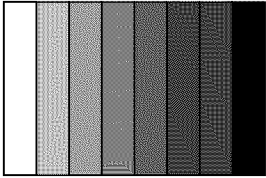
	Adjustment point	Adjustment conditions	Adjustment procedure
1	Setting	Signal: XGA (1024x768) 60Hz SYNC: HV separate	<ul style="list-style-type: none"> <li>Send the 100% color bar signal to the Video 4 analog RGB input.</li> </ul>  <p>XGA (1024x768) 100% color bar</p> <p>↑ 100% white                      ↑ 0% black</p>
2	Automatic adjustment execution		Point the cursor to [■ANALOG RGB ADJ] and press the [Enter] key. The adjustment is complete when [■ANALOG RGB ADJ OK] is displayed.

## 8.2.7 Tuner/V-CHIP adjustment

	Adjustment point	Adjustment conditions	Adjustment procedure
1	Setting	NTSC RF signal US-7(AIR)ch	<ul style="list-style-type: none"> <li>Send the NTSC signal to the RF antenna input.</li> </ul>
2	Automatic adjustment execution		Point the cursor to [■TUNER VCHIP TEST(*07ch)] and press the [Enter] key. (* Adjust the selected channel to the in-house signal.) The adjustment is OK when [■A-OK(***)/VM-OK] is displayed in green. (NG when A-NG/VM-NG is displayed in red.) It is OK when the deviation from the center frequency is $\pm 0.0625$ MHz or less.

## 9. White balance adjustment

### 9.1. White balance adjustment (For details about the adjustment procedure, refer to “Kameyama Model Integrated Monitor WB Adjustment Specification V1.92”).

	Adjustment point	Adjustment conditions	Adjustment procedure
1	Setting		1) Set the unit to the following conditions. AV MODE: [DYNAMIC] Backlight: +16 OPC: OFF Active Contrast: OFF Power Saving: OFF Aging Time: Min. 60 minutes 2) Connect the unit with the white balance adjustment jig.
2	Automatic adjustment execution	[Command] Process mode KRSW0001 KKT10037  Setting KY0F0000 OSDS0001 SBSL0016  Multi-point adjustment mode MSET0011  Point 6 LEV60229 MG6G**** MG6B**** MG6R**** MG6Y****  Point 5 LEV50173 MG5G**** MG5B**** MG5R**** MG5Y****  Point 4 LEV40133 MG4G**** MG4B**** MG4R**** MG4Y****  Point 3 LEV30116 MG3G**** MG3B**** MG3R**** MG3Y****  Point 2 LEV20074 MG2G**** MG2B**** MG2R**** MG2Y****  Point 1 LEV10045 MG1G**** MG1B**** MG1R**** MG1Y****  Writing MSET0003	[Adjustment procedure] 1) Send the “adjustment process” code using the remote control. 2) Set the point 6 to the specified gradation, specify the strongest color as the fixed color, and adjust the RGB so that it becomes the standard value through negative adjustment. Then compare the R and G values; based on the result, calculate the Ye value in the following conditions. $R > G: Y_e = G \times 1.05$ $R \leq G: Y_e = R \times 1.05$ * If the Ye value exceeds the initial value (input gradation x 4), it is rounded to that value or less. 3) Set the point 5 to the specified gradation, set the G correction value (692 x G value of point 6/916) (fractions rounded off) and the Ye correction value (692 x Ye value of point 6/916) (fractions rounded off), and adjust the RB so that it becomes the standard value. 4) Set the point 4 to the specified gradation, set the G correction value (532 x G value of point 6/916) (fractions rounded off) and the Ye correction value (532 x Ye value of point 6/916) (fractions rounded off), and adjust the RB so that it becomes the standard value. 5) Set the point 3 to the specified gradation, set the G correction value (464 x G value of point 6/916) (fractions rounded off) and the Ye correction value (464 x Ye value of point 6/916) (fractions rounded off), and adjust the RB so that it becomes the standard value. 6) Set the point 2 to the specified gradation, set the G correction value (296 x G value of point 6/916) (fractions rounded off) and the Ye correction value (296 x Ye value of point 6/916) (fractions rounded off), and adjust the RB pattern so that it becomes the standard value. 7) Set the point 1 to the specified gradation, set the G correction value (180 x G value of point 6/916) (fractions rounded off) and the Ye correction value (180 x Ye value of point 6/916) (fractions rounded off), and adjust the RB so that it becomes the standard value. 8) Write the adjustment value by the MSET0003 command and turn off the AC power. * RGB initial value of point 6: Set gradation 916 * RGB initial value of points 1 to 5: G correction value of each point (At each point, make adjustment so that the remainder of the RGB adjustment value/4 is equal.) [Adjustment value] * According to the “Standard settings” submitted by the Technical Department [LC52LE920UN] LE920 model teaching set

Adjustment point	Adjustment conditions	Adjustment procedure			
		[Adjustment standard value] Measuring instrument: [Minolta CA-210] Technical measuring instrument			
		Level	Reference value	Adjustment spec	Inspection spec
Point 6	916	X=0.272	±0.0010	±0.0020	
		y=0.277			
Point 5	692	X=0.272	±0.0010	±0.0020	
		y=0.277			
Point 4	532	X=0.272	±0.0015	±0.0030	
		y=0.277			
Point 3	464	X=0.272	±0.0020	±0.0040	
		y=0.277			
Point 2	296	X=0.272	±0.0030	±0.0060	
		y=0.277			
Point 1	180	X=0.272	±0.004	±0.0080	
		y=0.277			
Remarks		Setting conditions for inspection AV MODE: [DYNAMIC] (Reset) Monochro: ON OPC: OFF Active Contrast: OFF Power Saving: OFF Aging Time: Min. 60 minutes			

## 10. Key writing

### 10.1. EDID writing (Main PWB: QPWBXF452WJZZ)

Adjustment point	Adjustment conditions	Adjustment procedure
1 HDMI EDID writing (Main PWB)	Process mode Model discrimination check	1) Enter the process mode. 2) Point the cursor to [HDMI EDID WRITE] and press the [ENT] key. The writing is complete when [OK] is displayed. (If not written, HDMI does not function.)  CAUTION: Perform the data writing after setting the model discrimination. The data based on the model discrimination information is recorded in EEPROM.
2 Analog RGB EDID writing (Main PWB)	Inspection mode File version check	1) Write the EDID data for analog RGB into IC509 mounted on the main PWB using the checker. TL511 ●●● I2C clock, TL508 ●●● I2C data TL544 ●●● 5V, TL507 ●●● GND TL585 ●●● Write protection (H: WP, L: write enable) 2) Perform the data writing before making inspection using the checker.

### 11. Factory setting

After completing the factory setting, pull out the AC cord to complete the setting.

**CAUTION:** Do not turn on the power after completing the factory setting. If the power is turned on, configure the factory setting again.

	Adjustment point	Adjustment conditions	Adjustment procedure
1	Factory setting	Complete the setting by pulling out the AC cord.	<ul style="list-style-type: none"> <li>•Point the cursor to [INDUSTRY INIT], set to "ON" using [+] / [-] of the [VOL] key, and press the [ENT] key.</li> </ul> <p>The version confirmation screen appears on the green screen. It is completed when [SUCCESS] is displayed at the top. (If error occurs, [ERROR] is displayed on the red screen.)</p> <ul style="list-style-type: none"> <li>•Turn off the AC power.</li> </ul> <p>The following items are initialized when configuring the factory setting.</p> <ol style="list-style-type: none"> <li>1) User set value</li> <li>2) Channel data (broadcasting frequency, etc.)</li> <li>3) Password setting value</li> <li>4) Operating time</li> <li>5) StandbyCause</li> <li>6) Auto installation flag</li> <li>7) V-CHIP block setting value</li> </ol>

### 12. Software version

1. Main microcomputer
2. Monitor microcomputer
3. EDID data (Analog RGB)
4. (Reference: File name in the Technical Department)  
For analog RGB Input3: IC509: edid\_dsub15\_fullhd\_v6\_256.BIN

### 13. Writing the inch and model name onto EEPROM

Writing method

1. Pull out the AC cord.
2. Copy the application for writing inch/model name (HLI2MA01.USB) and model/inch file (52LE920.MDL) to the USB memory.
3. Hold down the power button and insert the AC cord.
4. Release the power button after 5 seconds.
5. Update starts.

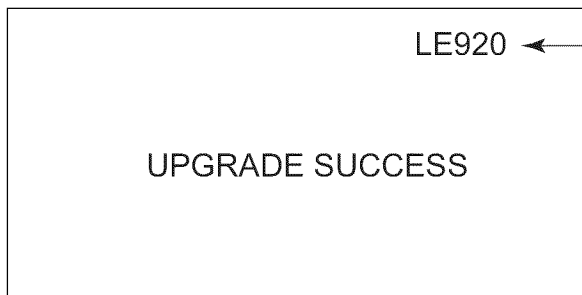

The inch and model name are displayed.

6. Pull out the AC cord.

Model/inch file

- 52LE920.MDL
- 60LE920.MDL
- \* 32 inch is not necessary.

**NOTE:** When replacing the main PWB, make sure to perform the writing the inch and model name onto EEPROM



## [2] PUBLIC MODE SETTING PROCEDURE

### 1. How to start Public Mode

- There are the following 3 ways to get the public mode setup screen displayed.

- ① In the adjustment process mode, turn on "PUBLIC MODE"
- ② 1) Plug AC cord and turn on the TV.  
2) After picture displayed, touch the "POWER" key for 5seconds.

NOTE: Picture will disappear when you touch the power key, but keep touching it.

- 3) When the center icon LED blinks, release your finger from the power key.
- 4) Next, touch the "POWER" key with the "CH ( ^ )" key and "VOL (+)" key touching.
- 5) When the center icon LED turns on, release your finger form the keys.

- ③ It's same as ② from 1) to 3)

- 4) Next, touch the "POWER" key with the "INPUT" key and "CH ( ^ )" key touching.
- 5) When the center icon LED turns on, release your finger form the keys.
- 6) Get the password input screen displayed.

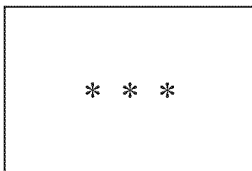
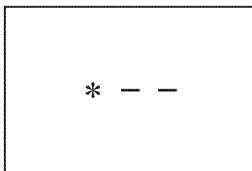
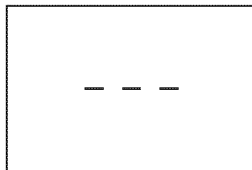

#### Procedure

- The input starts with the leftmost digit.
- Use the numeric keys [1] thru [9] and [0] keys on the remote controller. The other keys are not acceptable.
- With a numeric-key input, "-" will change to "\*". The input position will move one digit to the right.
- With all the 3 digits entered, the password will be verified.

- 7) The 3-digit password is now verified.

The password [0] [2] [7] provides for the public mode screen. (This screen comes on with whatever adjustment process settings.)

With any other passwords, the screen changes to the normal mode.

### 2. How to exit Public Mode

There are the following ways to quit the public mode setup screen.

- Turn off "PUBLIC MODE" in the adjustment process mode. (☆) ← This way alone is not for quitting the setup screen, but for quitting the mode itself.
- Turn off the power with the "POWER" key. (★)
- Select "EXECUTE". (★)

★... "PUBLIC MODE" stays on in the adjustment process mode.

☆... The settings will be back to the factory ones.

### 3. Public Mode Setting Values

- With the factory settings made, the public mode settings get initialized. (The adjustment process remains intact.)

**4. Public Mode Menu**

The guidance is not displayed on screen.

Setup procedure

- To move the cursor up and down, use the "cursor UP/DOWN" key (remote controller) and "CH ( ^ )/( v )" key (remote controller and set).
- To change the settings, use the "cursor RIGHT/LEFT" key (remote controller) and "VOL (+)/(-)" key (remote controller and set).
- To save new settings, keep the cursor at "EXECUTE" and use "ENTER" key (remote controller and set).

PUBLIC MODE	
POWER ON FIXED	[VARIABLE ]
MAXIMUM VOLUME	[ 60 ]
VOLUME FIXED	[VARIABLE ]
VOLUME FIXED LEVEL	[ 20 ]
RC BUTTON	[RESPOND ]
PANEL BUTTON	[RESPOND ]
MENU BUTTON	[RESPOND ]
AV POSITION FIXED	[VARIABLE ]
ON SCREEN DISPLAY	[YES ]
INPUT MODE START	[NORMAL ]
INPUT MODE FIXED	[VARIABLE ]
LOUD SPEAKER	[ON ]
RC_PATH_THROUGH	[OFF ]
232C POWON	[DISABLE ]
PUBLIC MODE	[OFF ]
RESET	
EXECUTE	

## 5. On Setting Items

\* "EZ-SETUP" discussed below indicates "EZ-SETUP after the first power-on".

### 1) POWER ON FIXED

Selection	Selection between "Variable" and "Fixed" (loop provided)
Default	– (Variable)
Explanation	In "Fixed" setting, the power-off by the power key of the unit is invalidated and the image is kept being received. The power can be turned off by stopping the power supply from AC.
Limit in Setting	Refer to the "Power-On Fixed" sheet.
Exception	None
Remarks	• In "Variable" setting, the power operation is in wait for 1 sec. and then turned off when the main power switch is off.

### 2) MAXIMUM VOLUME

Selection	Adjustment from 0 to 60 (no loop)
Default	60
Explanation	Sound volume can not be adjusted higher than the preset value.
Limit in Setting	<ul style="list-style-type: none"> <li>• When the sound volume is set lower than 59, only figures are displayed and the sound volume bar is not displayed.</li> <li>• The maximum sound volume for ON-timer (Wake up timer) is limited also to the preset value.</li> </ul>
Exception	
Remarks	• When the sound volume is set higher than the MAX setting by the adjusting process, the sound volume control operation is prohibited for turn-up and the sound volume should be turned down to MAX in this state.

### 3) VOLUME FIXED

Selection	Selection between "Variable", "Fixed", "ACON (AC CTRL)" and "AC/RCON (AC/RC CTRL)" (loop provided)
Default	Variable
Explanation	<ul style="list-style-type: none"> <li>• FIXED: Fixed at the level adjusted for a fixed volume.</li> <li>• AC CTRL: Start-up at the level specified for a fixed volume at ACON.</li> <li>• AC/RC CTRL: Start-up at the level specified for a fixed volume at start.</li> </ul>
Limit in Setting	<ul style="list-style-type: none"> <li>• The sound volume for the ON-timer (Wake up timer) is fixed also without display of menu. Besides, the setting is made impossible. (Basically, the menu is not displayed.)</li> <li>• The following keys become invalid: <ul style="list-style-type: none"> <li>• Sound volume Up/Down (VOL +/-) [for both remote control and the unit]</li> <li>• Mute (MUTE)</li> </ul> </li> </ul>
Exception	• In the item "VOLUME" of adjustment process, the sound volume can be set freely irrespective of this setting.
Remarks	<ul style="list-style-type: none"> <li>• As for sound volume fixing and sound volume MAX level, the sound volume fixing has priority.</li> <li>• Once the sound volume has been changed by adjustment process, it should be set back to the sound volume preset by sound volume fixing level when the adjustment process ends.</li> </ul>

### 4) VOLUME FIXED LEVEL

Selection	Adjustment from 1 to 60 (no loop)
Default	20
Explanation	The sound volume to be fixed by "Volume fixed" is determined.
Limit in Setting	None
Exception	None
Remarks	Setting is valid only when "Volume fixed" is selected for "fixed".

### 5) RC BUTTON

Selection	Selection between "Respond", "No Respond" and "Limited" (loop provided)
Default	Respond
Explanation	<p>Making the remote controller settings.</p> <ul style="list-style-type: none"> <li>• At the "No Respond" setting, the remote controller keys are disabled. Its power key (reception/standby key) is disabled too.</li> <li>• At the "Limited" setting, some channel-related keys alone are operative. All the other remote controller keys (power, volume ▲/▼, channel ▲/▼, light control (brightness sensor), broadcast select) are inoperative.</li> </ul>
Limit in Setting	① In "No respond" setting, all the keys (including the power key) are not accepted.
Exception	<ul style="list-style-type: none"> <li>• Adjustment process, inspection process and hotel only keys are valid irrespective of setting.</li> <li>• All the keys can be used in adjustment process, inspection mode and hotel menu irrespective of setting.</li> </ul>
Remarks	

## LC-52LE920UN/LC-60LE920UN

### 6) PANEL BUTTON

Selection	Selection between "Respond" and "No respond" (loop provided)
Default	Respond
Explanation	All the operations by keys (except the power key) of the unit can be invalidated.
Limit in Setting	
Exception	<ul style="list-style-type: none"> <li>• Adjustment process, inspection mode and hotel menu mode can be started irrespective of setting.</li> <li>• All the keys can be used in adjustment process, inspection mode and hotel menu irrespective of setting.</li> </ul>
Remarks	

### 7) MENU BUTTON

Selection	Selection between "Respond" and "No respond" (loop provided)
Default	Respond
Explanation	In "No respond" setting, the menu operation by the menu key of the remote control and the menu key of the unit are invalidated.
Limit in Setting	
Exception	<ul style="list-style-type: none"> <li>• Adjustment process, inspection mode and hotel menu mode can be started irrespective of setting.</li> <li>• All the keys can be used in adjustment process, inspection mode and hotel menu irrespective of setting.</li> </ul>
Remarks	

### 8) ON SCREEN DISPLAY

Selection	Selection between "Yes", "No" (loop provided)
Default	Yes
Explanation	<ul style="list-style-type: none"> <li>• At the "No" setting, the following items are not displayed on screen: register, setting, adjustment menu, channel call and volume bar.</li> </ul> <p>On the wide-screen models, an input selection is immediately made because the menu is not displayed.</p> <ul style="list-style-type: none"> <li>• At the "Limited" setting, some items cannot be displayed on screen.</li> </ul> <p>On the Japan-destined models, the channel call "Message" alone cannot be displayed. (This is because the channel call message may be confused with a message being sent from the hotel.)</p> <p>On the North America-destined models, the OSD works the same as at the "No" setting.</p>
Limit in Setting	<ul style="list-style-type: none"> <li>• Keys falling under any of the following items become invalid.</li> </ul> <ol style="list-style-type: none"> <li>① Appearance of screen changes and the sound changes.</li> <li>② Personal functions which are hard to restore.</li> </ol> <p>Screen display, menu, OFF-timer, ON-timer, AV MODE, screen size switching, clock setting, treble emphasis, AUDIO ONLY, sound changeover, LANGUAGE, CLOSED CAPTION</p>
Others	<ul style="list-style-type: none"> <li>• Simple input switching is generated. Those which are restored soon after leaving as they are and may be requested for change by customer are not prohibited.</li> </ul> <p>Brightness sensor (BACKLIGHT) and PIC. FLIP</p>
Exception	<ul style="list-style-type: none"> <li>• Such a caution which is displayed independently is displayed as it is.</li> </ul> <p>Non-responding signal caution</p>
Remarks	<ul style="list-style-type: none"> <li>• When CC has already been ON, CLOSED CAPTION is displayed.</li> </ul>

### 9) INPUT MODE START

Selection	Selection between "Normal", "Air (✳)", "INPUT 1/2/3", "PC", "HDMI 1/2/3/4/5", "DVI" (loop provided)
Default	Normal
Explanation	In power-ON, the input source to be started or channel can be set. (In standard mode, the operation follows the last memory.)
About options	<ul style="list-style-type: none"> <li>• All the input sources in the model are made selectable.</li> <li>• In TV mode, the channel to be set follows the last memory and the content of the last memory is included in the notation by options. Ex.) Air (2), Cable (98.1) etc.</li> </ul>
Limit in Setting	<ul style="list-style-type: none"> <li>• The display of channel setting menu and the channel setting operation are prohibited.</li> </ul>
Exception	
Remarks	<ul style="list-style-type: none"> <li>• In setting at "Normal", the setting of "Input mode fixed" is changed to "Variable" and selection should be prohibited.</li> </ul>

## 10) INPUT MODE FIXED

Selection	Selection between "Variable", "Fixed", "ACON (AC CTRL)" and "AC/RCON (AC/RC CTRL)" (loop provided)
Default	– (Variable)
Explanation	<ul style="list-style-type: none"> <li>• At the "Fixed" setting, the TV set gets started with the settings of "Input mode start", and then any other channels and inputs are not accepted.</li> <li>• At the "ACON (AC CTRL)" setting, the TV set gets started with the settings of "Input mode start" under AC control.</li> <li>• At the "AC/RCON (AC/RC CTRL)" setting, the TV set gets started with the settings of "Input mode start" under either control.</li> </ul>
Limit in Setting	<ul style="list-style-type: none"> <li>• With the execution of hotel mode, the input source is forced to change to that set by "Input mode start" and the channel switching and input switching are prohibited thereafter.</li> <li>• ON-timer's (Wake-up timer) channel items are not displayed or the operation is prohibited. (Basically, they are not displayed.)</li> <li>• The following keys are invalidated. CH ▲ / ▼, direct tuning button, FLASHBACK, input</li> </ul> <p>*However, the keys (input switching and CH ▲ / ▼ keys) of the unit for menu operation remain valid.</p>
Exception	None
Remarks	<ul style="list-style-type: none"> <li>• In the following case, setting is cancelled and mode is changed to "Variable". ① When the setting of "Input mode start" is set to "Normal".</li> </ul>

## 11) RC\_PATH\_THROUGH

Selection	Selection between "OFF", "ON: TV RCE" and "ON: TV RCD" (loop provided)
Default	OFF
Explanation	Function to feed the remote controller-received signal to Pin 9 (open) on the RS232C.
Limit in Setting	None
Exception	None
Remarks	None

## 12) AV POSITION FIXED

Selection	Selection between "Variable" and "Fixed" (loop provided)
Default	Variable
Explanation	<p>In case of "Fixed" setting,</p> <ul style="list-style-type: none"> <li>– Menu "Picture" and "Audio" setting can't be changed like "Dynamic (Fixed)".</li> <li>– When "AV Mode" key is pressed, TV just displays current AV Mode (cannot be changed.).</li> </ul>
Limit in Setting	None
Exception	None
Remarks	<ul style="list-style-type: none"> <li>• When receiving with AV Position key, OPC, Dolby key and other direct audio select keys, the current display stays on and no setting can be changed.</li> <li>• Even by initializing personal information, the hotel-mode settings are kept intact. In this way, the AV positions, video and audio adjustment settings are not initialized.</li> </ul>

## 13) LOUD SPEAKER (ON/OFF)

Selection	Selection between "ON" and "OFF" (loop provided)
Default	ON
Explanation	If "OFF" is selected, TV stops Speaker output even without Headphone connected.
Limit in Setting	None
Exception	None
Remarks	<ul style="list-style-type: none"> <li>• Press the volume UP/DOWN key, and the mute icon appears for 4 seconds.</li> <li>• The mute key and audio-related keys are displayed with caution.</li> <li>• Usually, the headphones and monitor audio outputs can be adjustable.</li> </ul>

## 14) 232C POWON

Selection	Selection between "Disable" and "Enable" (loop provided)
Default	Disable
Explanation	In the standby mode, the power-on by the 232C command is enabled or disabled.
Limit in Setting	None
Exception	None
Remarks	None

## LC-52LE920UN/LC-60LE920UN

### 15)PUBLIC MODE (ON/OFF)

Selection	Selection between "ON" and "OFF" (loop provided)
Default	OFF
Explanation	In case of "ON", public mode settings are effected.
Limit in Setting	None
Exception	None
Remarks	The public-mode settings are operable only when this item is set at ON.

## CHAPTER 6. TROUBLESHOOTING TABLE

### [1] TROUBLESHOOTING TABLE

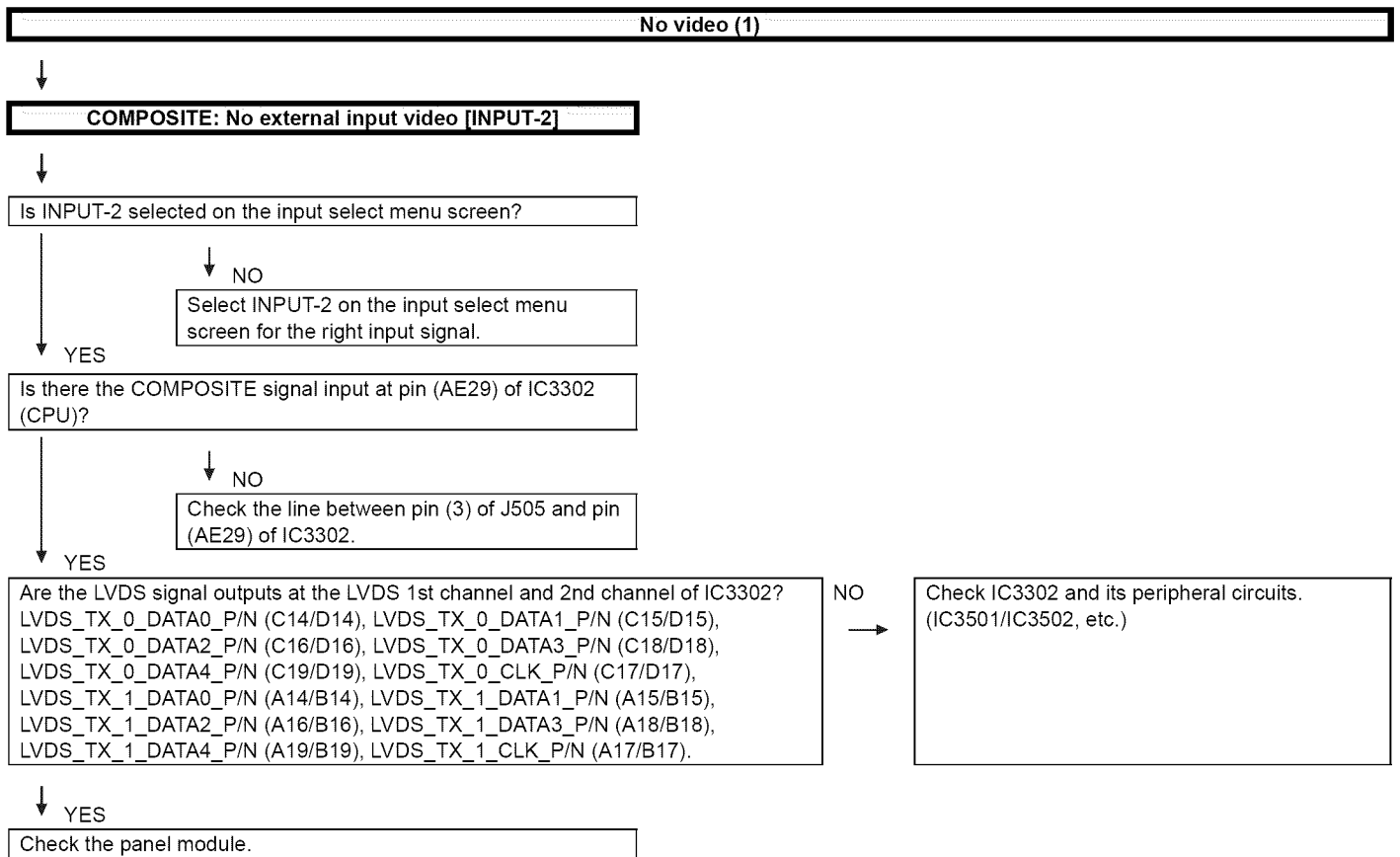

No video (2)

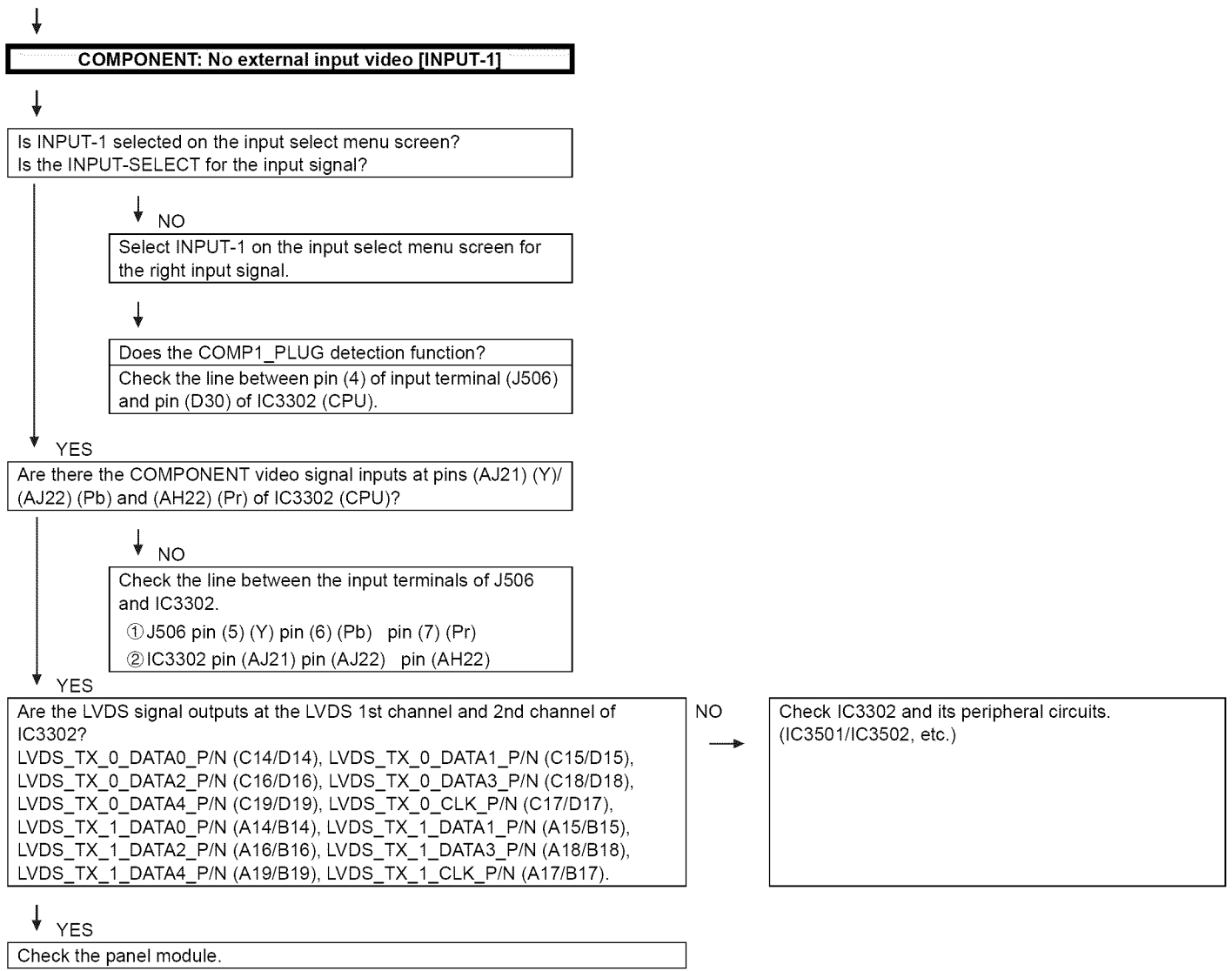



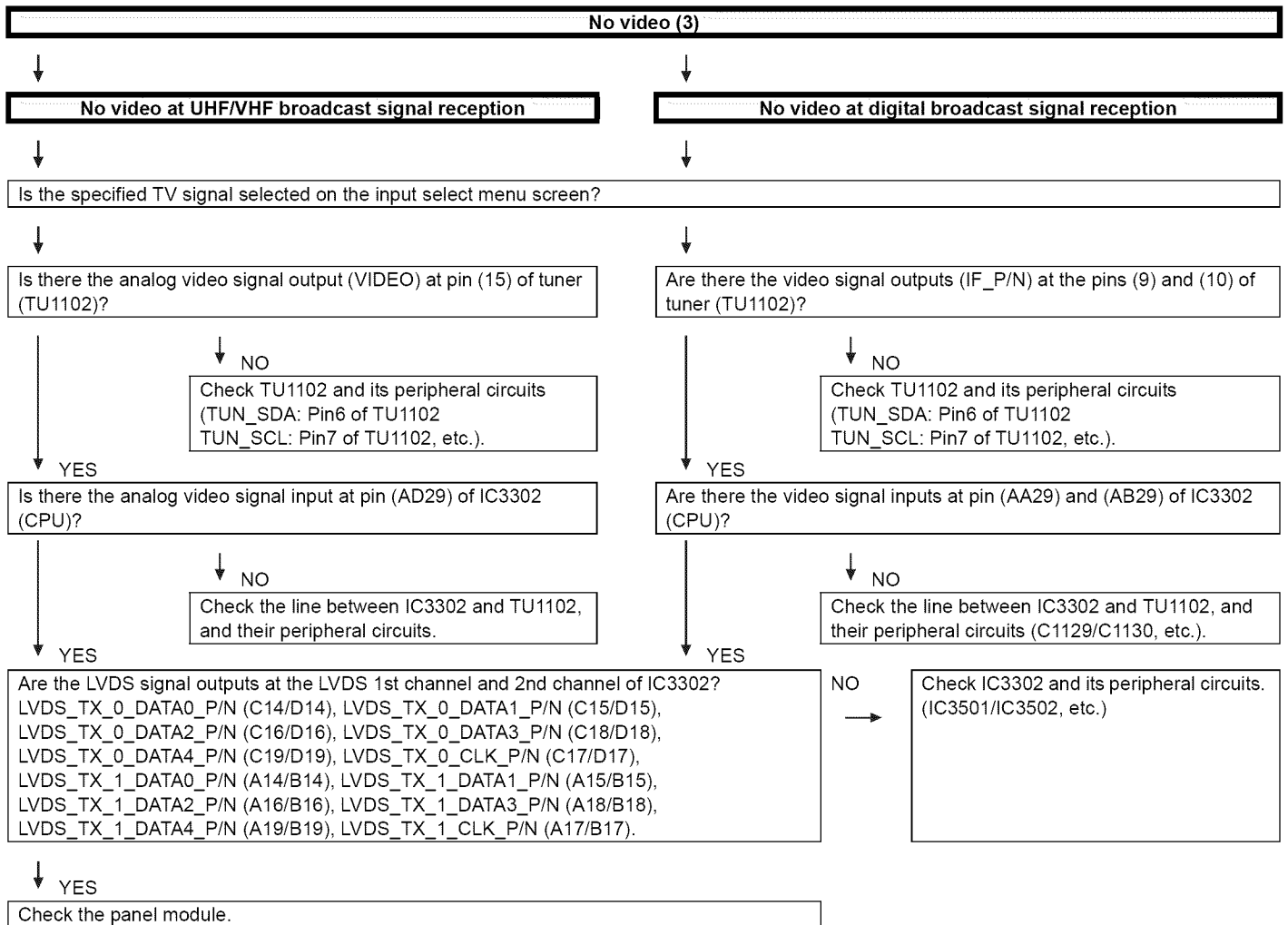

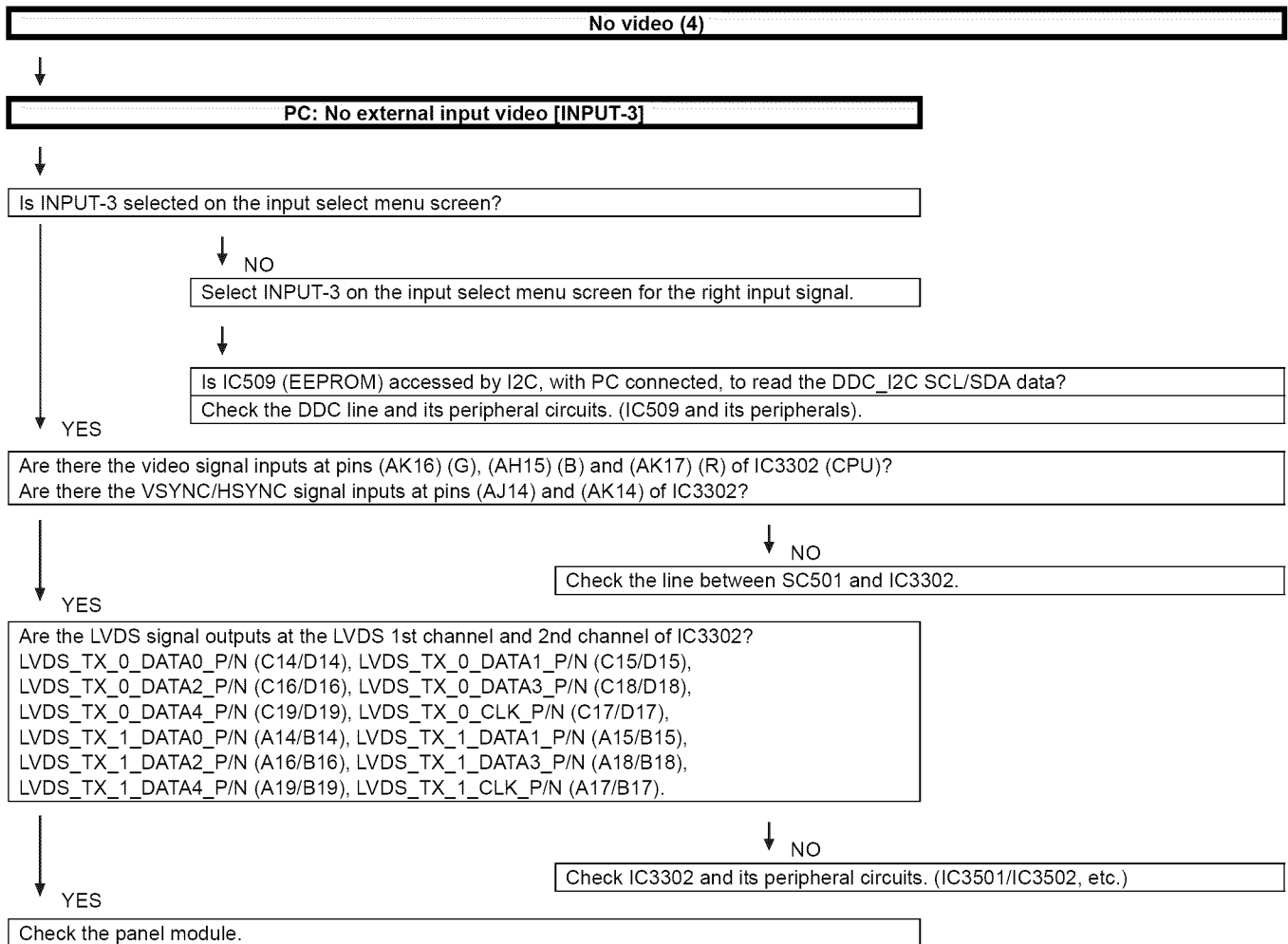

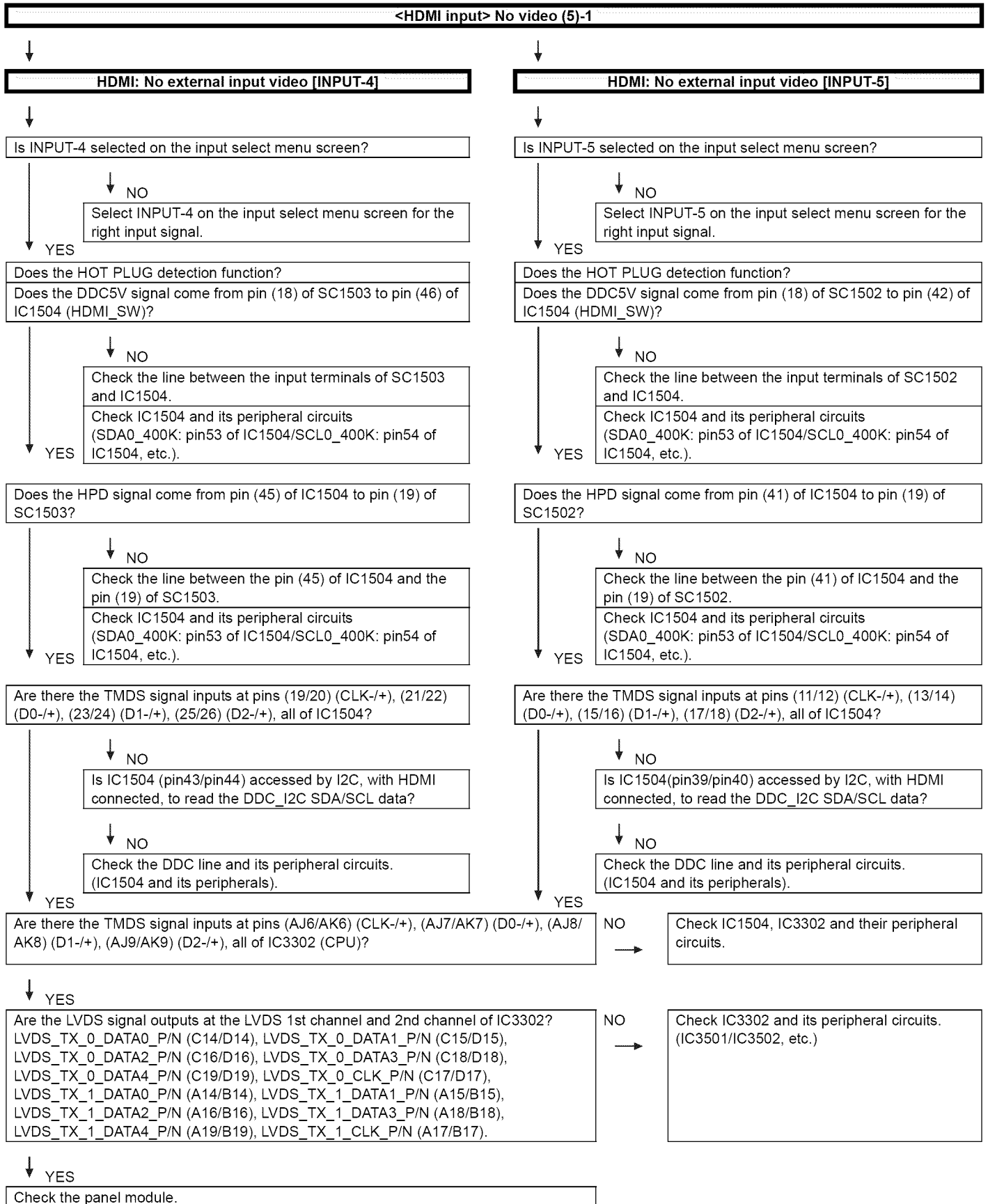

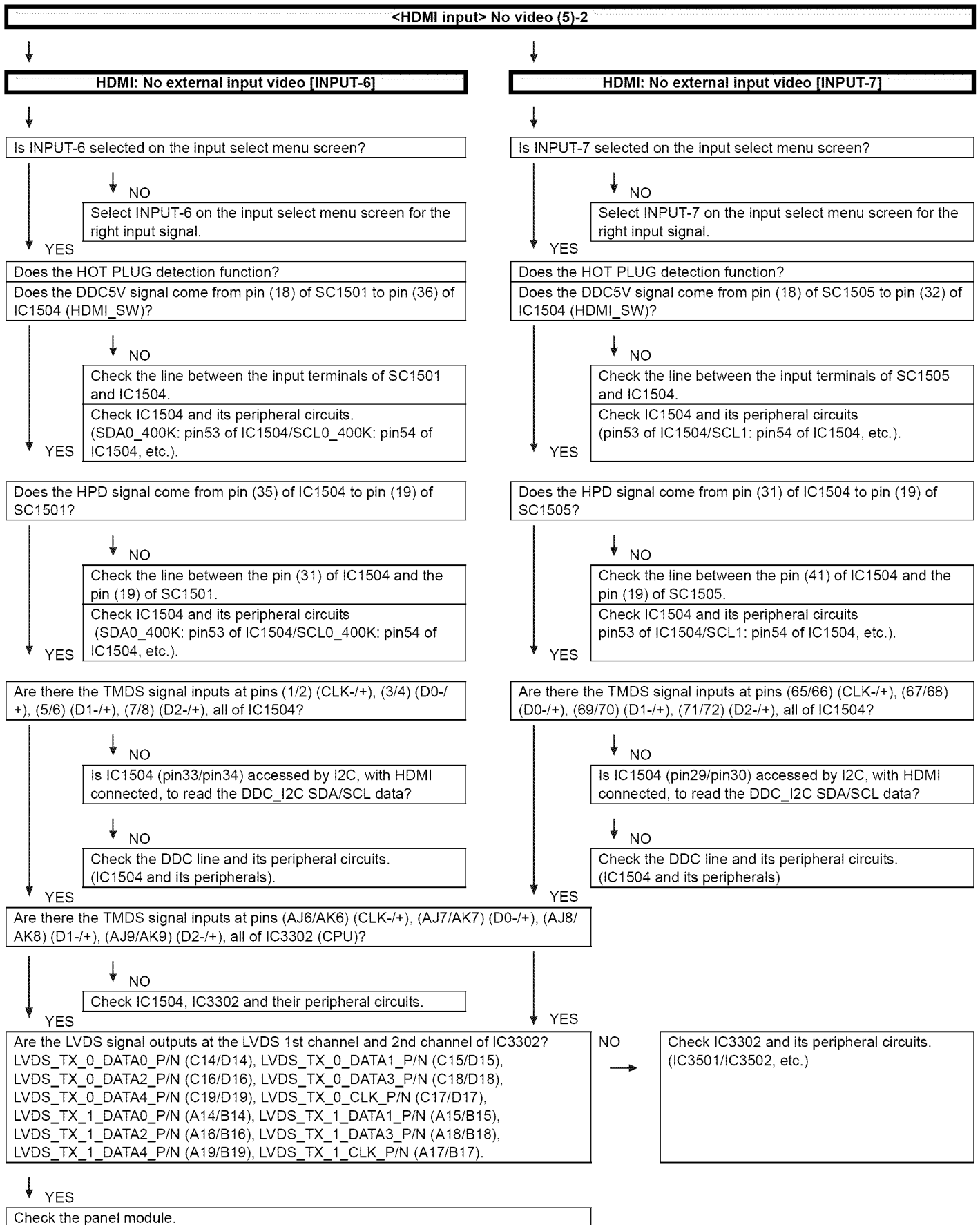

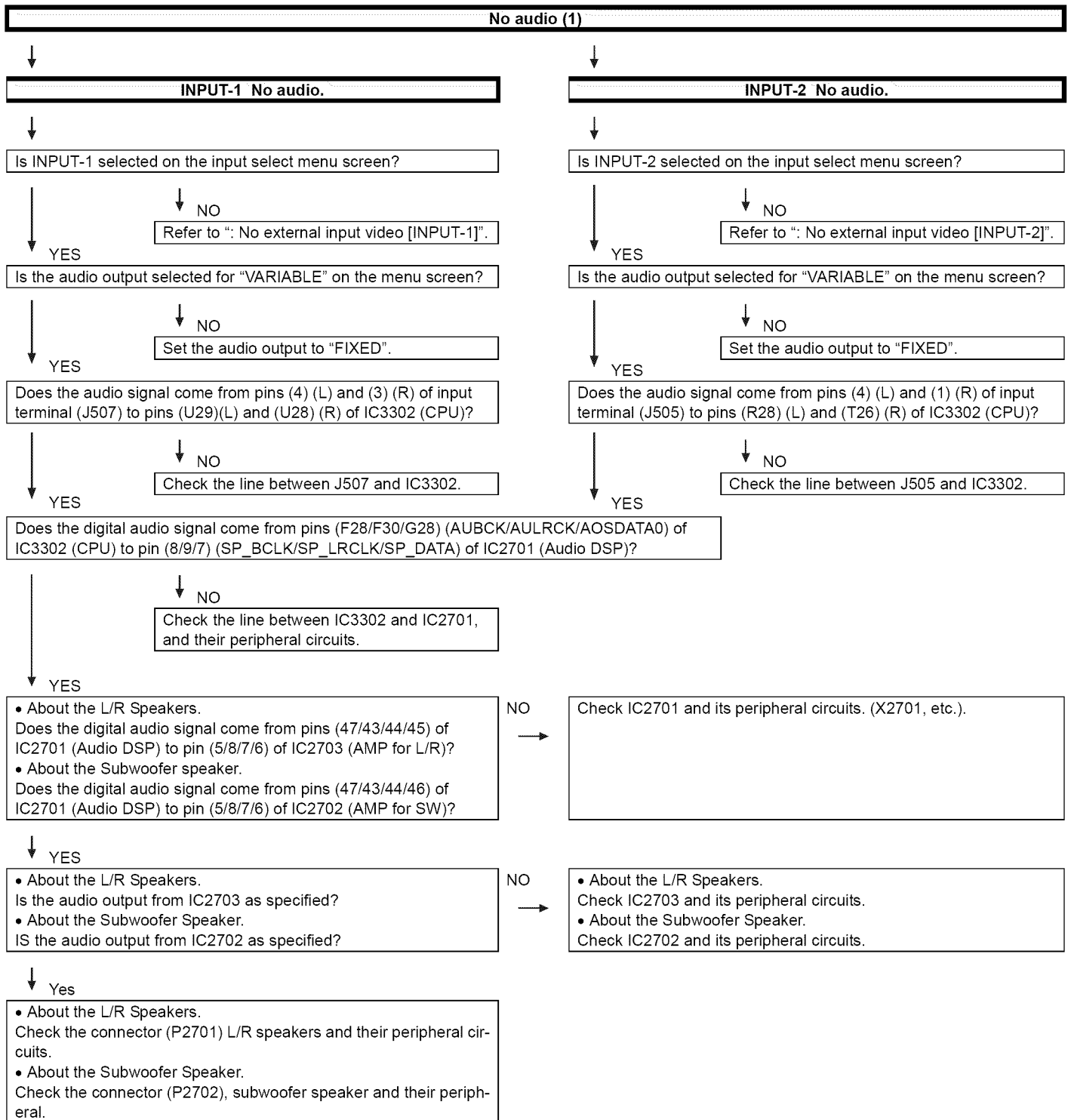

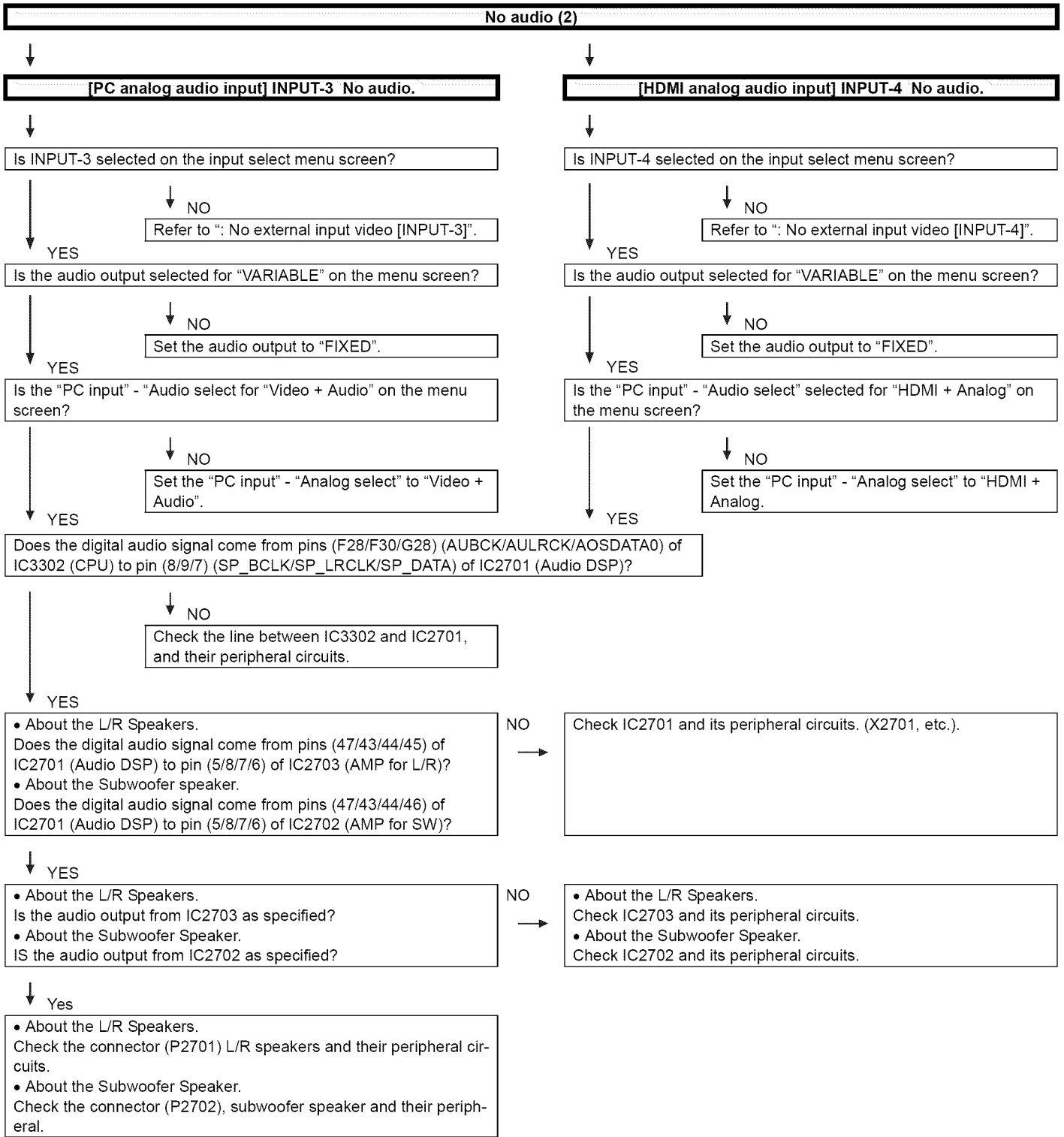

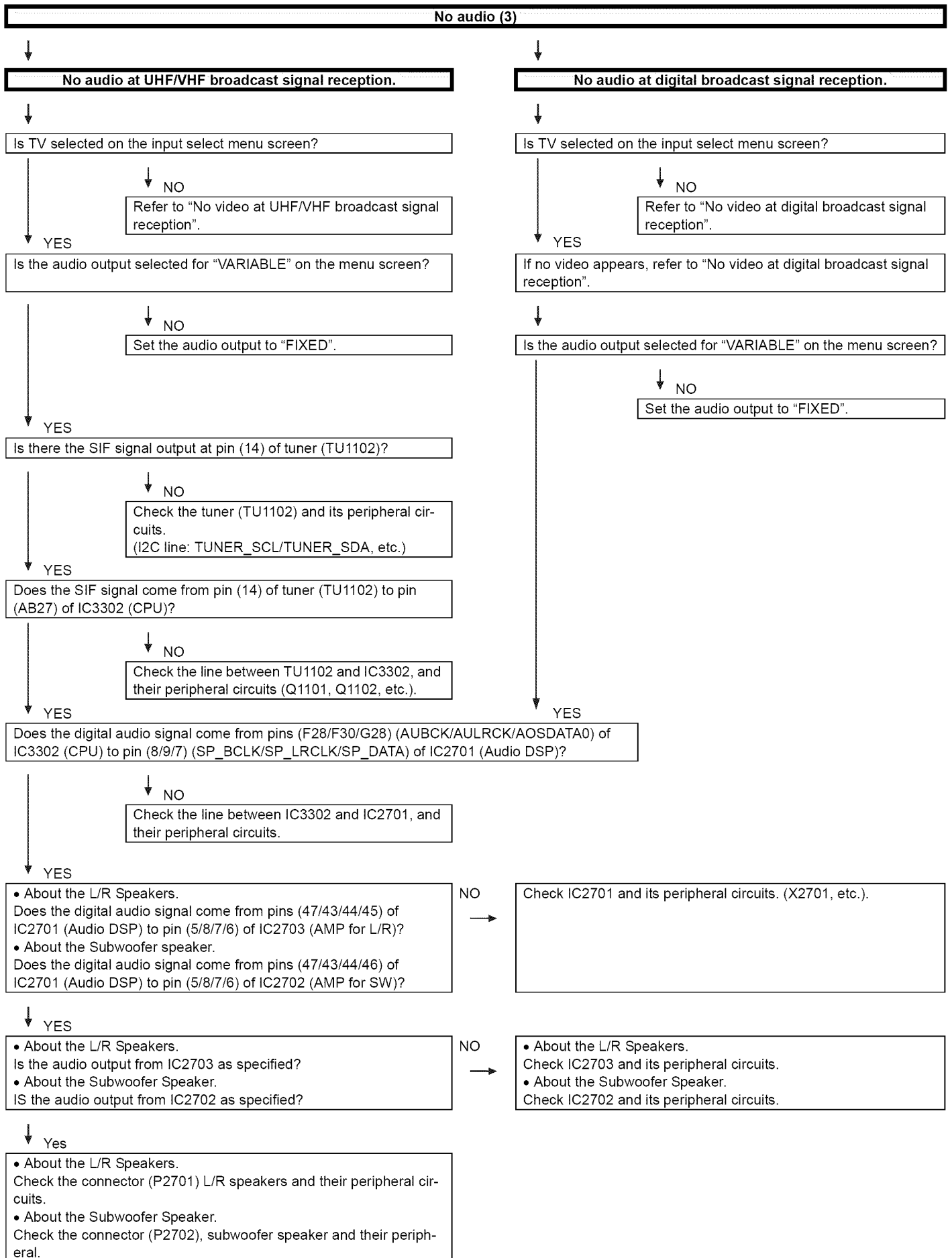

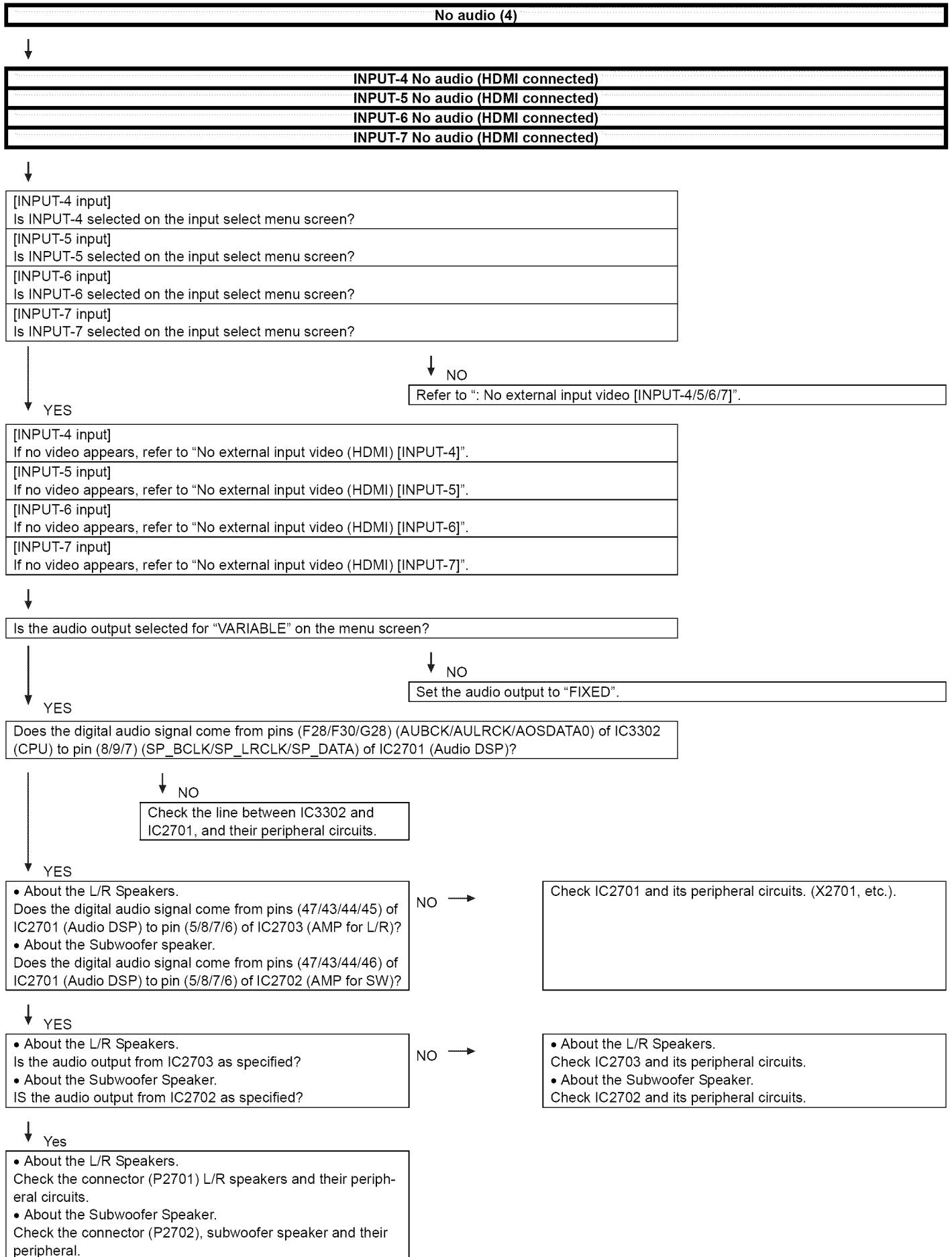



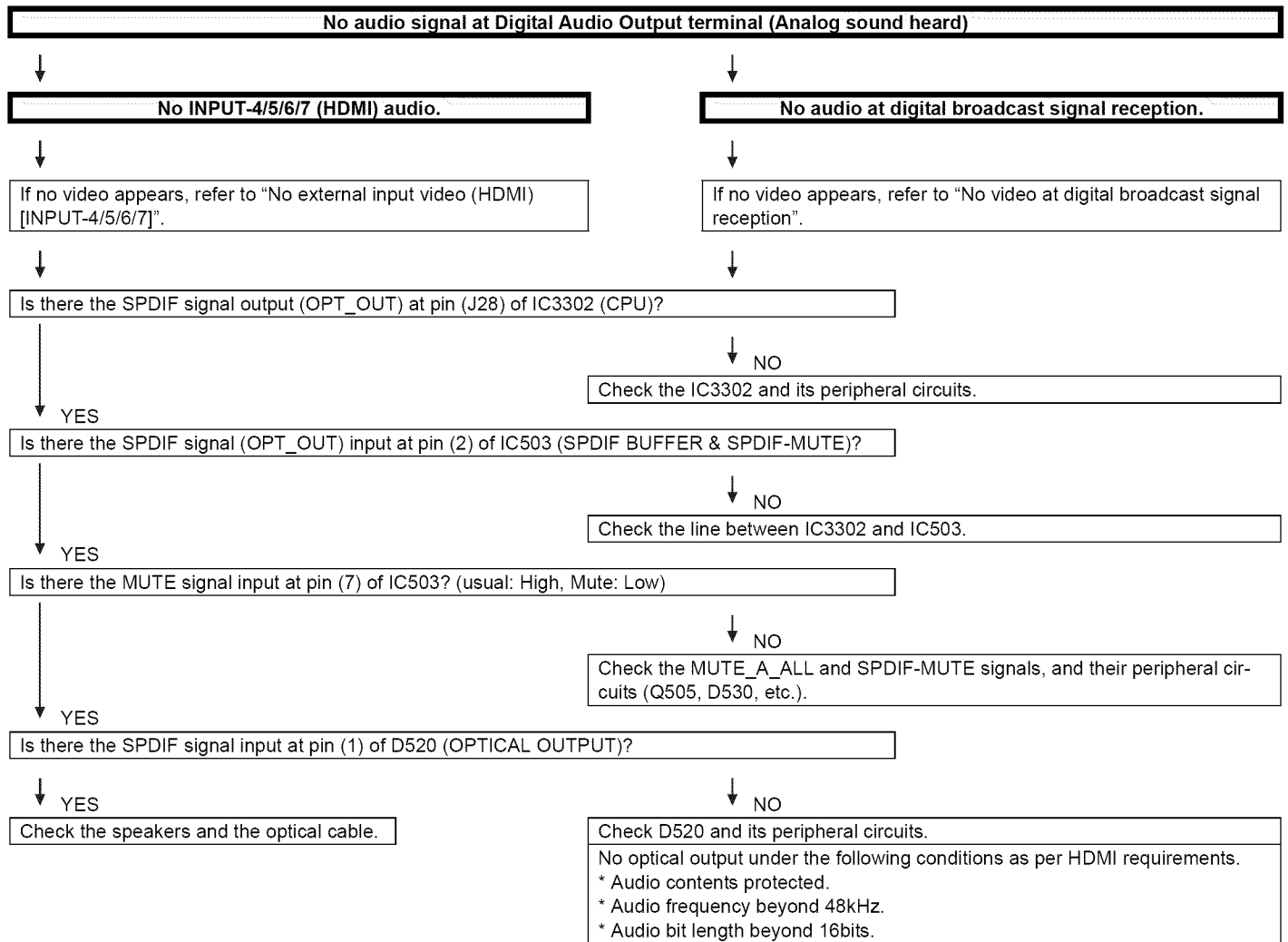

**No monitor audio output**

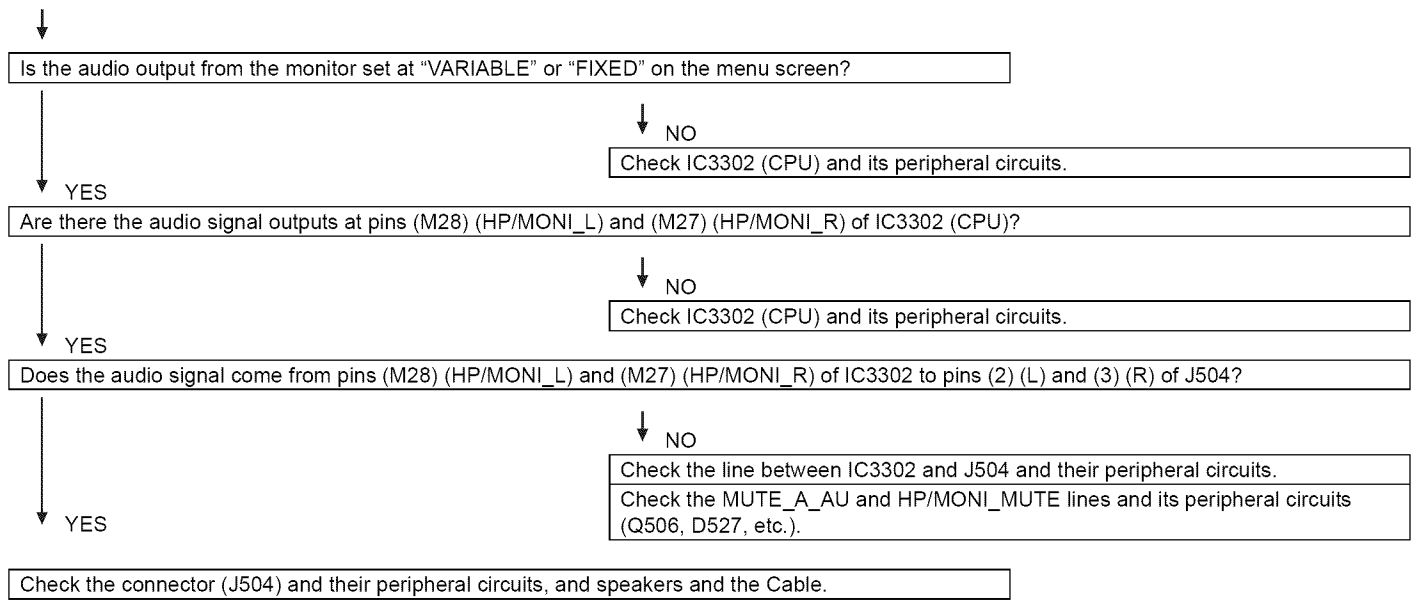

**No connect network**

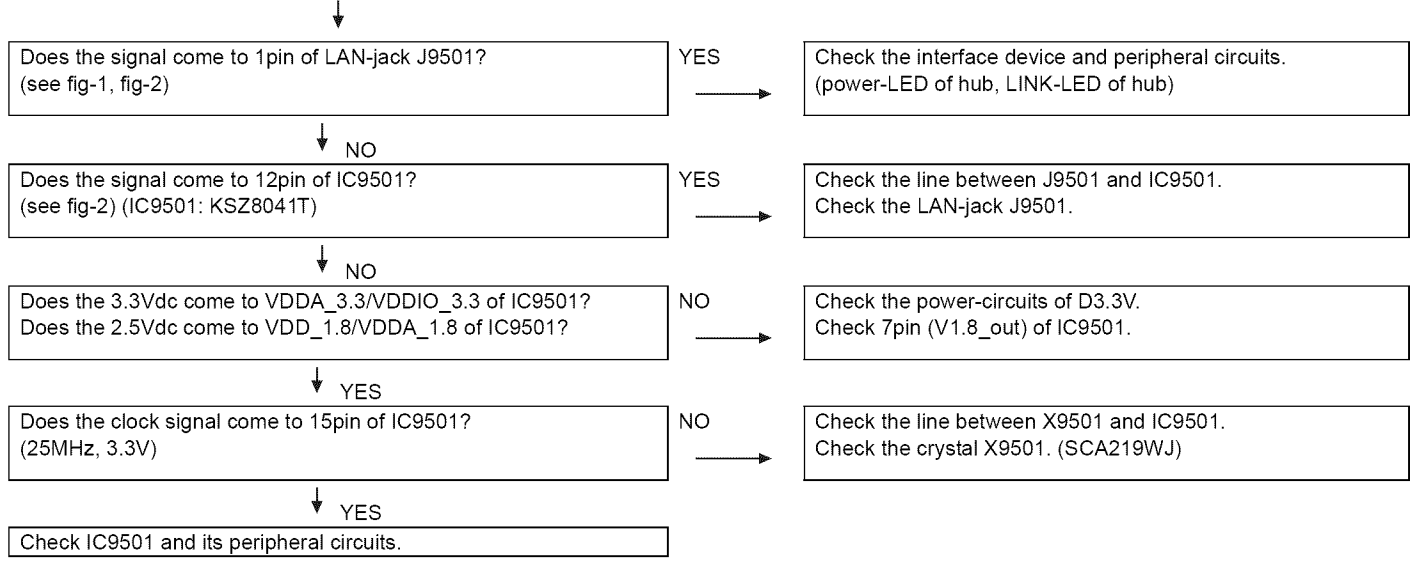

fig-1 LAN-jack J9501

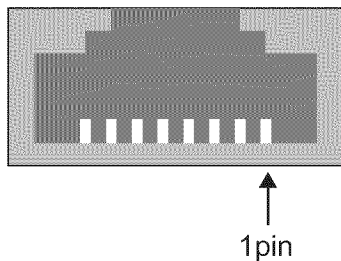
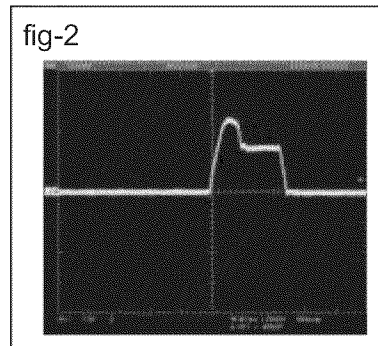

fig-2



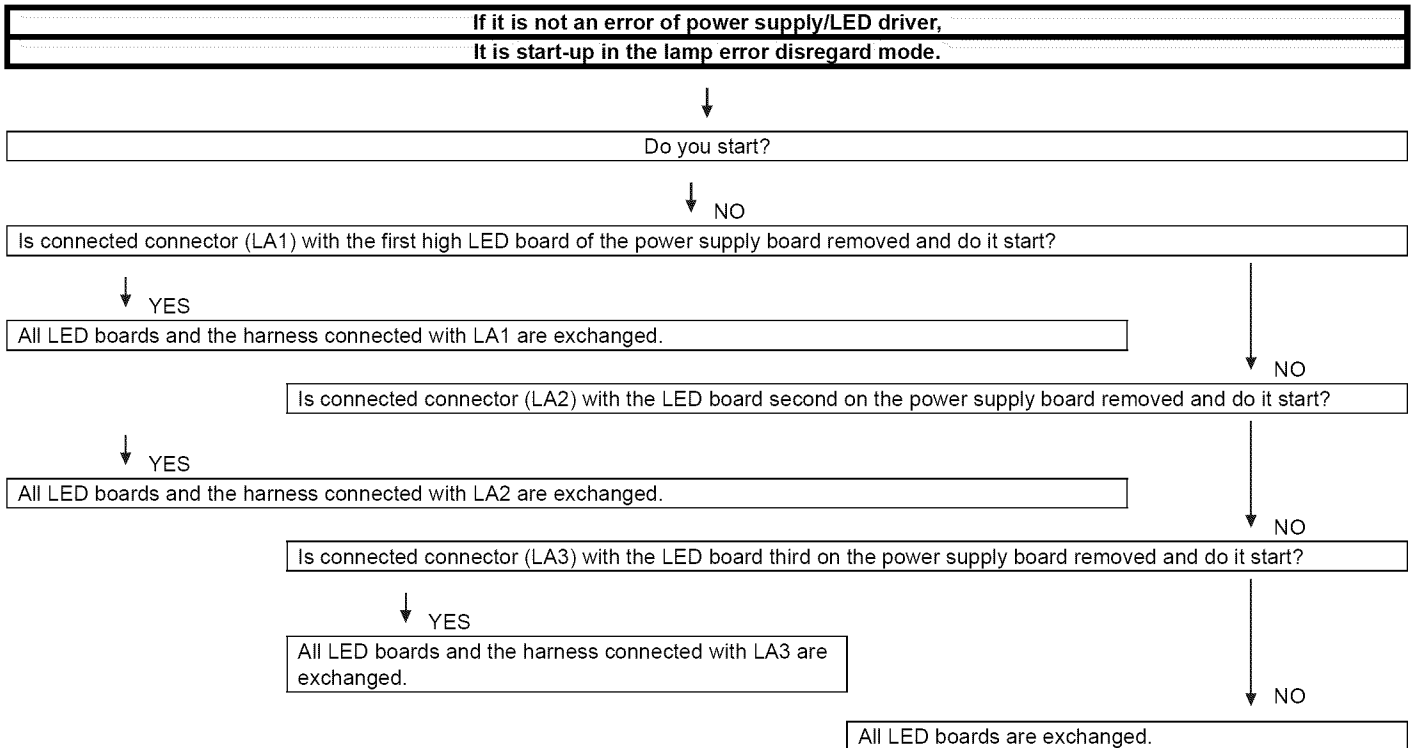
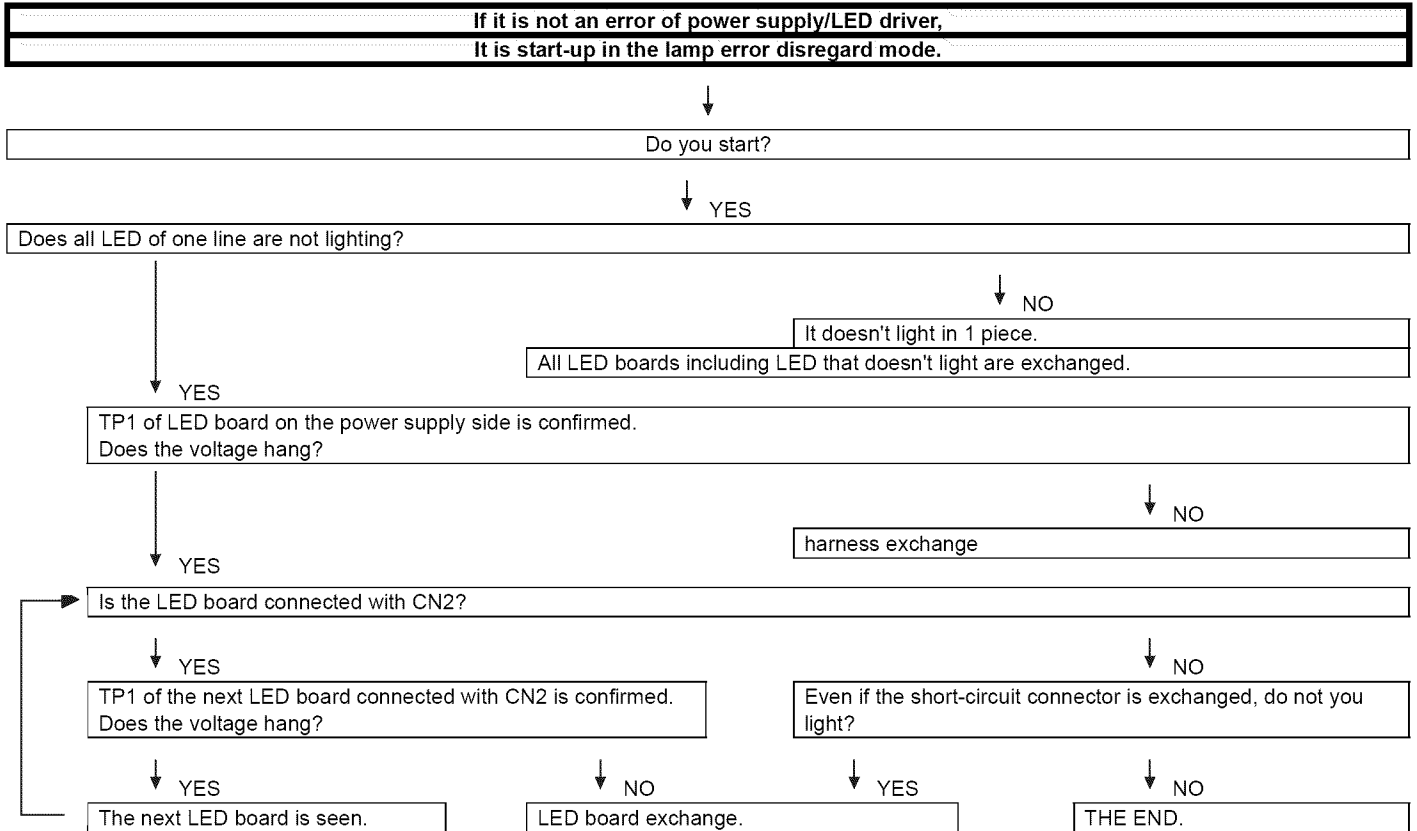



Table 1. Concrete flashing pattern

Item	Detail display		Cause
	Slow flashing	Fast flashing	
Inverter/Lamp system failure	Flashes once	Flashes once	Lamp error
Power PWB failure (Power failure, etc.)	Flashes twice	Flashes twice	Power supply error 2 (*2) UR+13V error
		Flashes 3 times	Power supply error 3 (*2) D3.3V error
		Flashes 5 times	Panel power supply error
Main PWB failure (Communication failure, etc.)	Flashes 3 times	Flashes once	Initial communication error
		Flashes twice	Start-up confirmation communication error
		Flashes 3 times	Regular communication error
		Flashes 5 times	Other communication error
Others	Flashes 4 times	Flashes once	Temperature error
		Flashes twice	Sync error
		Flashes 3 times	Notification from the main microcomputer (*3)
VerUP executing	Flashes smoothly	None	Version upgrading
VerUP succeeded	Flashes in a staircase pattern	None	Version upgrade succeeded
VerUP failed	None	Flashes continuously	Version upgrade failed
ROM data failure	None	Flashes continuously	Start-up after failing version upgrade (*4)

\*2: They depend on the system. Power supply error is defined from product to product.

\*3: For details, refer to ERROR STANDBY CAUSE on the adjustment process screen.

\*4: If the boot section is abnormal, there is no flashing (flashing impossible).

### 3. New method

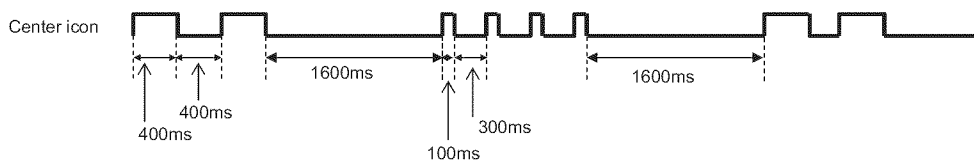

• Flashing during Verup

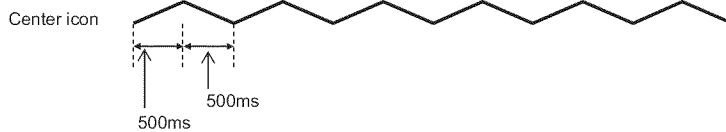

• Flashing when completing Verup

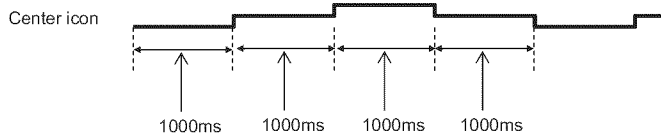

LED flashing timing chart at the time of an error



1) Inverter/Lamp failure details (Flashes slowly once and flashes fast)

Note

Error type	Center icon LED operation	Pins are monitor microcomputer pins unless otherwise specified.
Lamp failure Flashes fast once	H: On  L: Off	ERR_PNL(40pin): Hi failure. Confirmed after 8 consecutive detections at 64msec intervals (detected only when the backlight is on). Note that after five detection counts, the lamp cannot be activated except in the monitor process. Accumulated counts are cleared to 0 by the setting in the process A.

2) Power failure details (Flashes slowly twice and flashes fast)

Note

Error type	Center icon LED operation	Pins are monitor microcomputer pins unless otherwise specified.
SM_POW Main 13V failure Flashes fast twice	H: On  L: Off	DET_13V(38pin) failure (L). Main 13V is not applied. If error is detected during start-up or operation, the power is turned on again by polling.
D_POW Digital 3.3V failure Flashes fast 3 times	H: On  L: Off	DET_D3V3(36pin) failure (L). Digital 3.3V is not applied. If error is detected during start-up or operation, the power is turned on again by polling.
PANEL_POW Panel 12V failure Flashes fast 5 times	H: On  L: Off	DET_PNL12V(35pin) failure (L). Panel power is not applied. Detection is started after turning on the panel power and receiving command; the power is turned off by polling.

3) Communication failure details (Flashes slowly 3 times and flashes fast)

Note

Error type	Center icon LED operation	Basically, debug print logs are analyzed or communication logs are analyzed by a bus monitor.
Initial communication reception failure Flashes fast once	H: On  L: Off	Initial communication from the main CPU is not received. (Request for the monitor model No. is not received.) → Communication line failure or main CPU start-up failure
Start-up confirmation reception failure Flashes fast twice	H: On  L: Off	Start-up reason confirmation from the main CPU cannot be received. (Start-up communication until start-up reason notification command is not received.) → Main CPU start-up failure or monitor microcomputer reception failure
Regular communication failure Flashes fast 3 times	H: On  L: Off	Regular communication that is performed at 1 second intervals in the normal operation is interrupted. → Main CPU operation failure or monitor microcomputer reception failure
Other communication failure Flashes fast 5 times	H: On  L: Off	When a request (PM_REQ=H) is sent from the main microcomputer, the request command is not output from the main CPU, etc. → Main CPU operation failure or monitor microcomputer reception failure

## 4) Other failure details (Flashes slowly 4 times and flashes fast)

Note

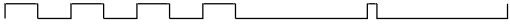
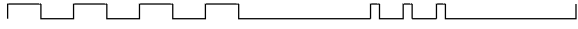
Error type	Center icon LED operation	Pins are monitor microcomputer pins unless otherwise specified.
Monitor temperature failure Flashes fast once	H: On  L: Off	If the panel temperature is 60°C or more for 15 seconds or more in a row, CAUTION appears on the OSD (flashes in red in the lower right screen). If the panel temperature is 60°C or more for 25 seconds or more in a row, error standby is activated. (MONITOR MAX TEMP on page 23 of the process A: Change of temperature failure AD value): Thermistor
Main failure Flashes fast 3 times	H: On  L: Off	Main microcomputer detection error (CPU temperature error, etc.) The details are displayed on page 1 of the process A of the main microcomputer.

## 4. Monitor ERR STBY table

Outline: Communication/Power failure detected by the monitor microcomputer is stored on EEPROM, and the last 4 abnormal states can be confirmed in the process mode A.

Location: Page 1 of the process mode A: MONITOR ERR CAUSE  
"0" if there is no error. It is cleared to 0 on the last page of the process mode A.

Display	Error description	
02	Start-up communication error 2	Initial communication from the main CPU is not received.
03	Start-up communication error 3	Only the initial communication is received.
04	Start-up communication error 4	Until panel information request reception
05	Start-up communication error 5	Until initialization completion reception
06	Start-up communication error 6	Until version notification transmission
07	Start-up communication error 7	Until start-up information notification transmission
08	Start-up communication error 8	Until start-up information response reception
09	Start-up communication error 9	Until time-out setting reception
0A	Communication error A	REQ time-out
0B	Communication error B	Restart time-out during the beginning of time acquisition start-up
0C	Communication error C	Ending sequence time-out
0D	Communication error D	Preset start-up time-out during completion
0E	Communication error E	download, start-up time-out
0F	Communication error F	Time acquisition time-out
11	Communication error H	Regular communication time-out
16	Panel-related error	Lamp failure
1A	Other error 2	Monitor temperature failure
1E	Power supply error 2	D_POW (DET_13V) failure
1F	Power supply error 3	D_POW (DET_D3V3) failure
21	Power supply error 5	Panel power failure
23	Other error 3	Error standby request from the main CPU

## CHAPTER 7. MAJOR IC INFORMATIONS

### [1] MAJOR IC INFORMATIONS

#### 1. MAJOR IC INFORMATIONS

##### 1.1. IC1504 (VHiSi9287+-1Q)

This IC is 4 input and 1 output HDMI port processor.

It integrated TMDS receiver and transmitter cores capable of receiving and transmitting at 2.25Gbps. (Supports video resolutions up to 1080p, 60Hz, 12bit.)

The Equalizer circuits to adapt long cable are integrated in This IC.

EDID and DDC support for 4 HDMI/DVI ports and 1 VGA port.(This IC includes 256-byte NVRAM and 256-byte SRAM for each port(5 total).)

##### 1.2. IC2002 (RH-iXC786WJQZQ)

The monitor microprocessor is intended to communicate with the main microprocessor and to operate the system.

It also controls power of the entire system.

##### 1.3. IC2702, IC2703 (VHiYDA164QZ-1Y)

The Class-D type digital audio power amplifier YDA164QZ gives maximum continuous output of 10 W/ch or woofer output 15W.

##### 1.4. IC3302 (RH-iXC951WJN1Q)

This LSI is FULL HIGH-DEFINITION 1080P DIGITAL TV SYSTEM-ON-A-CHIP.

It combines a cable/terrestrial 64/256-QAM and 8-VSB receiver, a transport processor, a digital audio processor, a high definition (HD) MPEG video decoder, 2D graphics processing, digital processing of analog video and audio, analog video digitizer and DAC functions, stereo high-fidelity audio DACs, HDMI receivers for 1080p 60 inputs, a 625-MHz processor, and a peripheral control unit providing a variety of television control functions.

The cable/terrestrial receiver directly samples a tuner output with an analog-to-digital converter (ADC).

The LSI digitally resample and demodulates the signal with recovered clock and carrier timing, filters and equalizes the data, and passes soft decisions to an ATSC/A74 and ITU-T J.83 Annex B-compatible decoder.

It has an MPEG-2 Digital Video Broadcasting (DVB)-compliant transport processor with advanced section filtering capability, DVB descrambler, and an MPEG-2 (MP@HL profile) video decoder.

Audio support includes a BTSC and a Dolby AC3/MPEG-2 Layer 1, 2, audio decoder.

The LSI provides analog and digital audio/video outputs.

A SPDIF output and a pair of analog outputs (L-R) are provided via the integrated audio DACs.

The NTSC analog video decoder is supported by its own motion adaptive deinterlacing and 3D comb filtering, including 1080i deinterlacing.

The LSI includes advanced 2D graphics processing.

One transport stream input is included.

The LSI incorporates a complete ARM11-based microprocessor subsystem including caches with bridging to memory and a local bus, where external peripherals can be attached.

Integrated peripherals include two USB 2.0, three UARTs, counter/timers and GPIO controllers.

In this time, H264 decode/VC-I decode/secure boot function are added to this IC.

##### 1.5. IC3501/IC3502 (RH-iXC754WJQZQ)

These are 1G bit (64M x 16bit) DDR2-1066 synchronous DRAM.

##### 1.6. IC8401 (RH-iXD047WJQZQ)

The 512M-bit NAND flash memory device stores the main CPU program.

##### 1.7. IC8455 (VHiR24064AS-1Y)

This is 64k-bit EEPROM device including the user setting.

##### 1.8. IC506 (VHiM3221EiP-1Y)

This IC is a high speed, single-channel RS-232 transceiver interface device that operates from a single 3.3V power supply.

The device provides the electrical interface between an asynchronous communication controller and the serial-port connector.

This device operate at data signaling rates up to 460kbit/s.

All RS-232(Tout and Rin) and CMOS (Tin and Rout) inputs and outputs are protected against electrostatic discharge (up to +/- 15kV ESD protection).

##### 1.9. IC9501(VHiKSZ8041T-1Y)

This IC is a single supply 10Base-T/100Base-TX Physical Layer Transceiver, which provides MII/RMII/SMII interfaces to transmit and receive data.



**1.10. IC2701 (VHiYSS951VZ-1Y)**

Audio DSP (YSS951VZ) has digital audio adjustment function (for example, PEQ, bass/treble, balance, bass enhancer, etc.) and adjusts TVs audio quality.



CHAPTER 8. OVERALL WIRING/SYSTEM BLOCK DIAGRAM

[1] OVERALL WIRING DIAGRAM

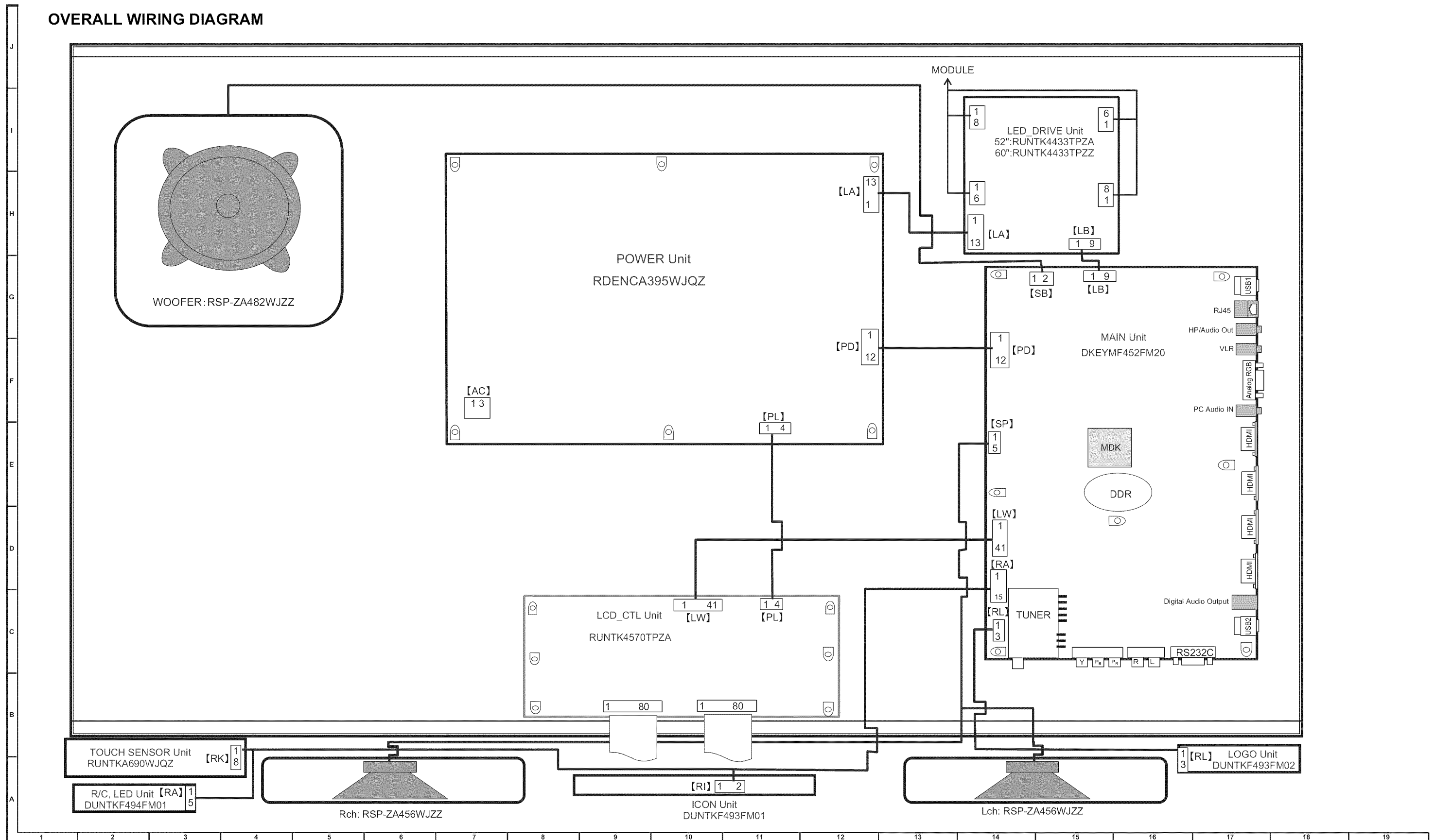

[2] SYSTEM BLOCK DIAGRAM

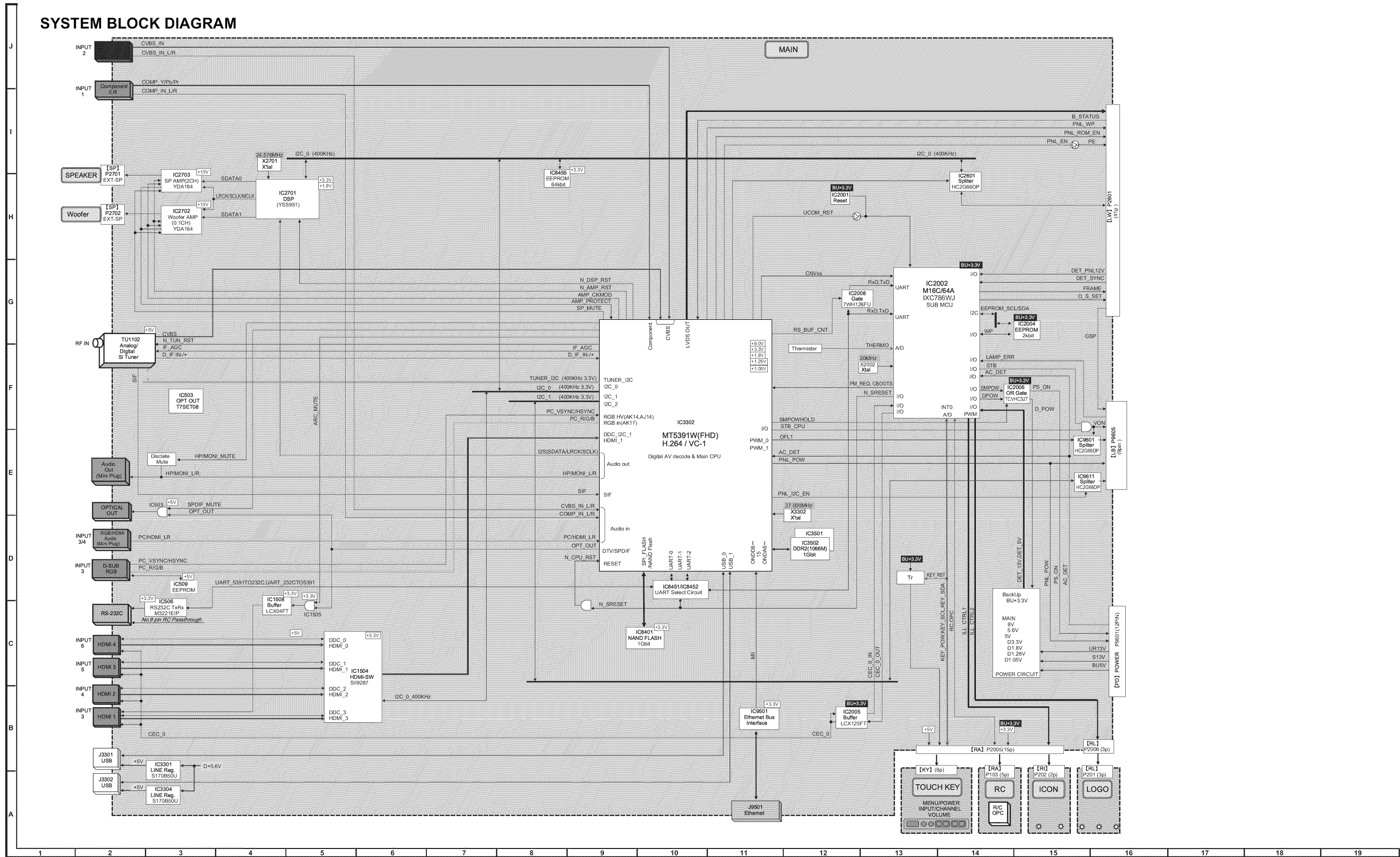

# SHARP PARTS GUIDE

No. S70I560LE920U/

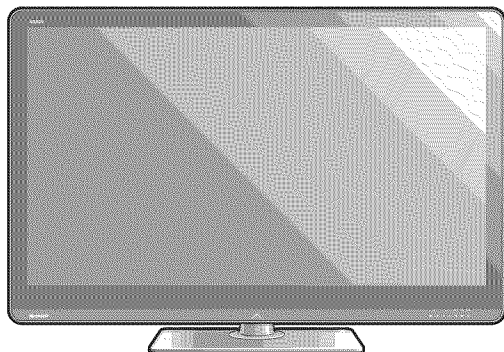

## LCD COLOR TELEVISION

**MODELS** **LC-52LE920UN**  
**LC-60LE920UN**

### CONTENTS

- |                                     |   |
|-------------------------------------|---|
| [1] PRINTED WIRING BOARD ASSEMBLIES | [6] PACKING PARTS (NOT REPLACEMENT ITEM) (LC-52LE920UN) |
| [2] LCD PANEL MODULE UNIT           | [7] PACKING PARTS (NOT REPLACEMENT ITEM) (LC-60LE920UN) |
| [3] CABINET PARTS (LC-52LE920UN)    | [8] SERVICE JIGS (USE FOR SERVICING)                    |
| [4] CABINET PARTS (LC-60LE920UN)    |   |
| [5] SUPPLIED ACCESSORIES            |   |

Parts marked with "△" are important for maintaining the safety of the set. Be sure to replace these parts with specified ones for maintaining the safety and performance of the set.

**SHARP CORPORATION**

Download from [Www.Somanuals.com](http://Www.Somanuals.com). All Manuals Search And Download.

This document has been published to be used for after sales service only.

The contents are subject to change without notice.

LC-52LE920UN/LC-60LE920UN

NO.	PARTS CODE	PRICE RANK	NEW MARK	PART DELIVERY	DESCRIPTION
<b>[1] PRINTED WIRING BOARD ASSEMBLIES</b>					
N	DKEYMF452FM20	BW		X	MAIN Unit
N	DUNTKF493FM01	AE		J	ICON Unit
N	DUNTKF493FM02	AF		J	LOGO Unit
N	DUNTKF494FM01	AG		J	R/C, LED Unit
N	RUNTKA690WJQZ	AZ		J	TOUCH SENSOR Unit
N	RDENCA395WJQZ	BP		X	POWER Unit
N	RUNTK4570TPZA	BU		X	LCD CONTROL Unit
N	RUNTK4433TPZA	BS		X	LED DRIVE Unit (LC-52LE920UN)
N	RUNTK4433TPZZ	BS		X	LED DRIVE Unit (LC-60LE920UN)
<b>[2] LCD PANEL MODULE UNIT</b>					
N	R1LK520D3LWB0Z	DX		X	52" LCD Panel Module Unit (LK520D3LWB0Z) (LC-52LE920UN)
N	R1LK600D3LW30Z	EK		X	60" LCD Panel Module Unit (LK600D3LW30Z) (LC-60LE920UN)

[3] CABINET PARTS (LC-52LE920UN)

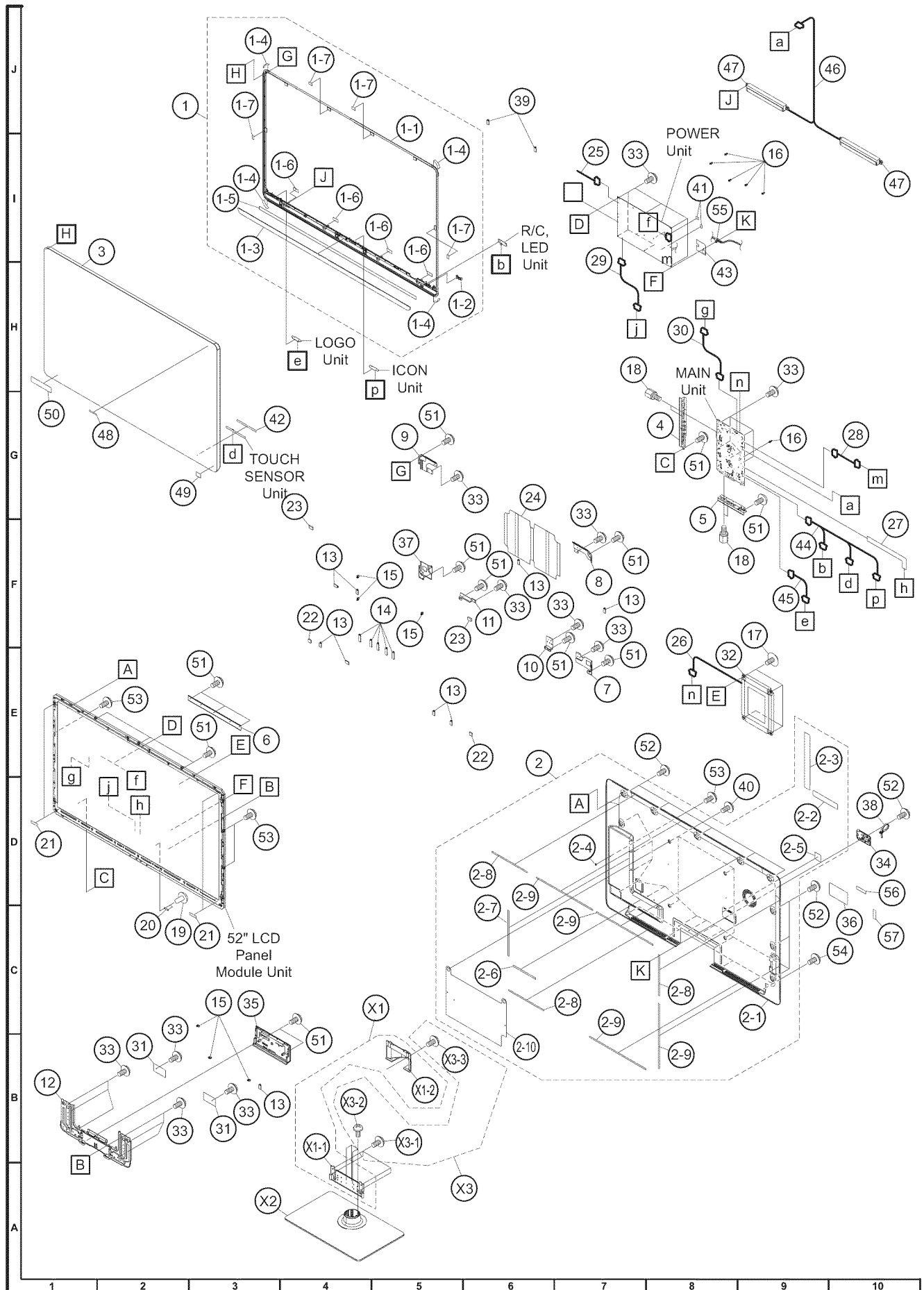

NO.	PARTS CODE	PRICE RANK	NEW MARK	PART DELIVERY	DESCRIPTION
<b>[3] CABINET PARTS (LC-52LE920UN)</b>					
1	CCABAC610WJ31	BQ	N	X	Front Cabinet Ass'y
1-1	Not Available	-	N	-	Front Cabinet
1-2	HDECQB420WJ3A	AB		X	R/C Decoration Cover
1-3	HDECZA051WJSA	AY	N	X	Front Decoration Plate
1-4	Not Available	-		-	Coner Tape, x4
1-5	PSPAGA908WJZZ	AE		J	Front Cab Spacer
1-6	PSPAHC201WJZZ	AA		X	Himelon, x4
1-7	Not Available	-		-	Spacer, x4
2	CCABBB695WE32	BQ		X	Rear Cabinet Ass'y
2-1	Not Available	-		-	Rear Cabinet
2-2	HiNDPD923WJSA	AF	N	X	Terminal Label (Bottom)
2-3	HiNDPD992WJSA	AP	N	X	Terminal Label (Side)
2-4	LX-WZA068WJF7	AB	N	X	Washer
2-5	PSPAHC152WJ3Z	AA		X	Spacer
2-6	PSPAHC159WJZZ	AA		X	Himelon
2-7	PSPAHC160WJZZ	AC		J	Himelon
2-8	PSPAHC194WJZZ	AA		X	Himelon, x3
2-9	PSPAHC309WJZZ	AB	N	X	Himelon, x4
2-10	PZETKA539WJKZ	AZ		X	Barrier Sheet
3	CPNLHA021WE02		N	X	Glass Front Panel Ass'y
4	GCOVAD734WJ00	AF		X	Terminal Cover (Side)
5	GCOVAD735WJ00	AE		X	Terminal Cover (Bottom)
6	LANGFA808WJFW	AE	N	X	BL Support Angle
7	LANGKC694WJFW	AD		X	LCD Fixing Angle B-L
8	LANGKC696WJFW	AD		X	LCD Fixing Angle T-L
9	LANGKC697WJFW	AD		X	LCD Fixing Angle T-R
10	LANGKC698WJFW	AB		X	LCD Fixing Angle B-MA
11	LANGKC810WJFW	AC		X	LCD Fixing Angle B-MB
12	LANGKD013WJ3W	AR	N	X	Stand Angle
13	LHLDWA175WJUJ	AC		J	Holder, x8
14	LHLDWA176WJUJ	AC		J	Holder, x5
15	LHLDWA289WJKZ	AC		J	Holder, x6
16	LHLDZA587WJKZ	AC		J	PWB Spacer, x6
17	LX-BZA364WJF7	AB		J	Screw, x4
18	NSFTZA362WJFW	AB		J	Shaft, x4
19	PCLICA014WJKZ	AA		X	Clip, x2
20	PMLT-A632WJZZ	AC		X	Absorber
21	PSPAGA888WJZZ	AB		J	Spacer, x4
22	PSPAGA913WJKZ	AB	N	X	Spacer, x2
23	PSPAGA934WJKZ	AB	N	X	Spacer, x2
24	PZETKA538WJKZ	AW		X	Insulator
25	QCNW-K549WJQZ	AF	N	X	Connecting Cord (LA:POW-DRIVE)
26	QCNW-K574WJQZ	AF		J	Connecting Cord (SB:MAIN-WOOFER)
27	QCNW-K577WJQZ	AR		J	Connecting Cord (LW:MAIN-LCD CTL)
28	QCNW-K976WJQZ	AG		J	Connecting Cord (PD:POW-MAIN)
29	QCNW-K977WJQZ	AE		J	Connecting Cord (PL:POW-LCD CTL)
30	QCNW-K978WJQZ	AF		J	Connecting Cord (LB:MAIN-DRIVE)
31	QEARZA186WJZZ	AD		X	Ground Part, x2
32	RSP-ZA482WJZZ	AX	N	X	Speaker (Sub Woofer)
33	XBPS730P06WS0	AA		J	Screw, x27
34	GCOVAD699WJ3A	AC		X	AC Cord Cover
35	GCOVAD816WJ3A	AE	N	X	Stand Cover
36	HiNDPD925WJSA	AB	N	X	Model Label
37	LANGKD010WJFW	AD	N	X	LCD Fixing Angle B-R
38	LHLDKA011WJKZ	AD		J	AC Cord Band
39	LHLDWA176WJUJ	AC		J	Holder, x2
40	LX-BZA170WJF9	AC		J	Screw, x4
41	PCUSGA142WJKZ	AF		J	Rubber Bush, x2
42	PSPAKA474WJKZ	AB	N	X	KEY PWB Spacer
43	PZETKA562WJKZ	AC		X	AC Barrier
44	QCNW-K562WJQZ	AW		J	Connecting Cord (RA:MAN-EN/KY/RC)
45	QCNW-K565WJQZ	AE		J	Connecting Cord (RL:MAIN-LOGO)
46	QCNW-K579WJQZ	AK		J	Connecting Cord (SP:MAN-SP(L/R))
47	RSP-ZA456WJZZ	AY	N	J	Speaker, x2 (L/R)
48	TLABZC586WJZZ	AF		J	Quattron Label
49	TLABZC618WJZZ	AB	N	X	Dolby Label
50	TLABZC619WJZZ	AE	N	X	Pop Label
51	XBPS730P06WS0	AA		J	Screw, x14
52	XBPS830P06WS0	AA		J	Screw, x19
53	XBPS830P14WS0	AB	N	J	Screw, x4
54	XEBS940P10000	AB		J	Screw, x4
55	QACDA074WJPZ	AG		X	AC Cord
56	TLABNB037WJZZ	AB		X	Serial Label (Back)
57	Not Available	-		-	Serial Label (Side)

△





NO.	PARTS CODE	PRICE RANK	NEW MARK	PART DELIVERY	DESCRIPTION
<b>[4] CABINET PARTS (LC-60LE920UN)</b>					
1	CCABAC609WJ31	BQ	N	X	Front Cabinet Ass'y
1-1	Not Available	-	N	-	Front Cabinet
1-2	HDECQB420WJ3A	AB		X	R/C Decoration Cover
1-3	HDECZA050WJSA	AZ	N	X	Front Decoration Plate
1-4	Not Available	-		-	Coner Tape, x4
1-5	PSPAGA909WJZZ	AC		X	Front Cab Spacer
1-6	PSPAHC201WJZZ	AA		X	Himelon, x4
1-7	Not Available	-		-	Spacer, x6
2	CCABBB696WE32	BQ		X	Rear Cabinet Ass'y
2-1	Not Available	-		-	Rear Cabinet
2-2	HiNDPD923WJSA	AF	N	X	Terminal Label (Bottom)
2-3	HiNDPD984WJSA	AP	N	X	Terminal Label (Side)
2-4	LX-WZA068WJF7	AB	N	X	Washer, x2
2-5	PSPAHC152WJ3Z	AA		X	Spacer
2-6	PSPAHC159WJZZ	AA		X	Himelon
2-7	PSPAHC160WJZZ	AC		J	Himelon
2-8	PSPAHC194WJZZ	AA		X	Himelon, x2
2-9	PSPAHC309WJZZ	AB	N	X	Himelon, x5
2-10	PZETKA539WJKZ	AZ		X	Barrier Sheet
3	CPNLHA022WE02		N	X	Glass Front Panel Ass'y
4	GCOVAD734WJ00	AF		X	Terminal Cover (Side)
5	GCOVAD735WJ00	AE		X	Terminal Cover (Bottom)
6	LANGFA808WJFW	AE	N	X	LB Support Angle
7	LANGKC698WJFW	AB		X	LCD Fixing Angle B-MA, x2
8	LANGKC701WJFW	AF		X	Stand Angle, x2
9	LANGKD023WJ3W	AB	N	X	LCD Fixing Angle B-M2, x2
10	LHLDWA133WJKZ	AC		J	Holder
11	LHLDWA175WJUJ	AC		J	Holder, x7
12	LHLDWA176WJUJ	AC		J	Holder, x4
13	LHLDWA289WJKZ	AC		J	Holder, x3
14	LHLDZA587WJKZ	AC		J	PWB Spacer, x6
15	LX-BZA364WJF7	AB		J	Screw, x4
16	NSFTZA362WJFW	AB		J	Shaft, x4
17	PCLiCA014WJKZ	AA		X	Clip, x4
18	PMLT-A636WJZZ	AD		X	Absorber
19	PMLT-A648WJZZ	AB	N	X	Absorber, x2
20	PSPAGA888WJZZ	AB		J	Spacer, x4
21	PSPAGA913WJKZ	AB	N	X	Spacer, x2
22	PSPAGA934WJKZ	AB	N	X	Spacer, x2
23	PZETKA538WJKZ	AW		X	Insulator
24	QCNW-K549WJQZ	AF	N	X	Connecting Cord (LA:POW-DRIVE)
25	QCNW-K570WJQZ	AG		J	Connecting Cord (SB:MAIN-WOOFER)
26	QCNW-K578WJQZ	AQ		X	Connecting Cord (LW:MAIN-LCD_CTL)
27	QCNW-K977WJQZ	AE		J	Connecting Cord (PL:POW-LCD_CTL)
28	QCNW-K979WJQZ	AE		X	Connecting Cord (PD:POW-MAIN)
29	QCNW-K980WJQZ	AE		X	Connecting Cord (LB:MAIN-DRIVE)
30	RSP-ZA482WJZZ	AX	N	X	Speaker (Sub Woofer)
31	XBBS740P06000	AA		J	Screw, x12
32	XBPS730P06WS0	AA		J	Screw, x18
33	GCOVAD699WJ3A	AC		X	AC Cord Cover
34	GCOVAD702WJKA	AR		X	Support Cover
35	GCOVAD864WJ3A	AM	N	X	Stand Cover
36	HiNDPD924WJSA	AB	N	X	Model Label
37	LANGKC694WJFW	AD		X	LCD Fixing Angle B-L
38	LANGKC696WJFW	AD		X	LCD Fixing Angle T-L
39	LANGKC697WJFW	AD		X	LCD Fixing Angle T-R
40	LANGKD010WJFW	AD	N	X	LCD Fixing Angle B-R
41	LHLDKA011WJKZ	AD		J	AC Cord Band
42	LHLDWA175WJUJ	AC		J	Holder, x6
43	LX-BZA170WJF9	AC		J	Screw, x4
44	LX-BZA313WJM1	AC	N	J	Screw, x2
45	LX-BZA366WJZZ	AA		X	Screw, x6
46	PCUSGA142WJKZ	AF		J	Rubber Bush, x2
47	PSPAKA474WJKZ	AB	N	X	KEY PWB Spacer
48	PZETKA562WJKZ	AC		X	AC Barrier
49	QCNW-K555WJQZ	AF		J	Connecting Cord (RL:MAIN-LOGO)
50	QCNW-K567WJQZ	AR		X	Connecting Cord (RA:MAN-EN/KY/RC)
51	QCNW-K568WJQZ	AG		X	Connecting Cord (SP:MAN-SP(L/R))
52	RSP-ZA456WJZZ	AY		J	Speaker, x2 (L/R)
53	TLABZC587WJZZ	AB		X	Quattron Label
54	TLABZC618WJZZ	AB	N	X	Dolby Label
56	XBPS730P06WS0	AA		J	Screw, x21
57	XBPS830P06WS0	AA		J	Screw, x19
58	XBPS830P14WS0	AB	N	J	Screw, x4
59	XBPS840P12000	AA		X	Screw, x3
60	XBPS950P12KS0	AA		X	Screw, x4
61	XEBS940P10000	AB		J	Screw, x7
62	CANGKC709WJ01	AY		X	Support Ass'y
63	CDAi-A711WJ02	BN	N	X	Stand Base Ass'y
64	QACDDA074WJPZ	AG		X	AC Cord
65	XWHS830-05080	AA	N	X	Washer, x2
66	TLABNB037WJZZ	AB		X	Serial Label (Back)
67	Not Available	-		-	Serial Label (Side)

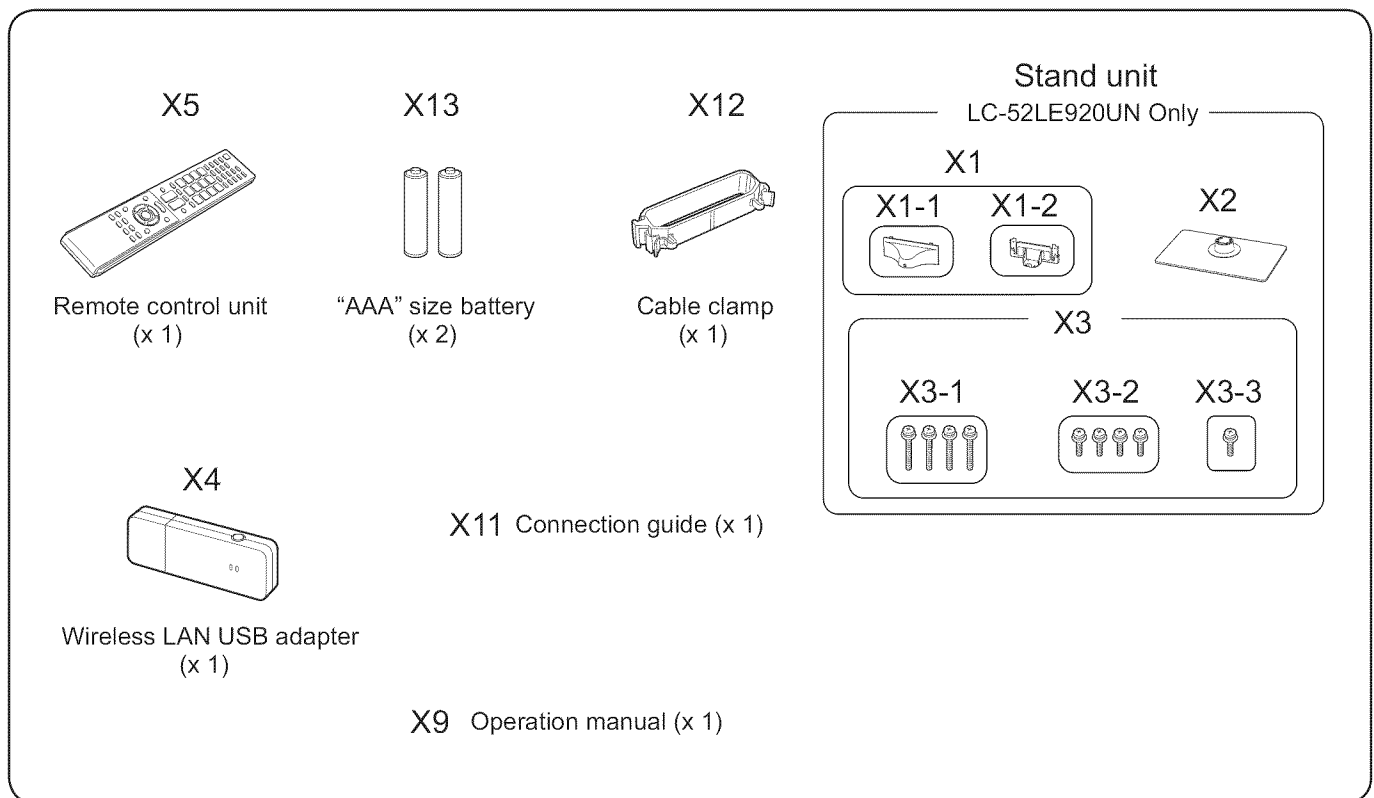

**[5] SUPPLIED ACCESSORIES**

NO.	PARTS CODE	PRICE RANK	NEW MARK	PART DELIVERY	DESCRIPTION
<b>[5] SUPPLIED ACCESSORIES</b>					
X1	CANGKC708WJ01	AX		J	Stand Support Ass'y (LC-52LE920UN)
X1-1	CANGKC708WJ03		N	X	Plate Support
X1-2	GCOVAD701WJKA		N	X	Support Cover
X2	CDAi-A710WJ04	BK	N	X	Stand Base Ass'y (LC-52LE920UN)
X3	CX-BZA363WJ01	AF		J	Stand Screw Ass'y (LC-52LE920UN)
X3-1	LX-BZA363WJZZ		N	X	Set Screw, x4
X3-2	LX-BZA370WJZZ		N	X	Stand Screw, x4
X3-3	XBBS840P08000	AB		J	Screw
X4	Ki-OUA001WJZZ	BD	N	X	Wi-Fi Dongle
X5	RRMCGA889WJSA	AR	N	X	Remote Control
X6	TCADEA243WJZZ	AB		X	Enquete Card
X7	Not Available	-		-	Caution Label
X8	Not Available	-		-	Guarantee Card
X9	TINS-E586WJZZ	AN	N	X	Operation Manual
X10	TMAN-A030WJZZ	AB		X	Netflix Handbill
X11	TMAN-A038WJZZ	AB	N	X	Connection Guide
X12	LHLDWA298WJKA	AD	N	J	Cable clamp
X13	UBATUA024WJZZ	AD		J	"AAA" size battery

[6] PACKING PARTS (NOT REPLACEMENT ITEM) (LC-52LE920UN)

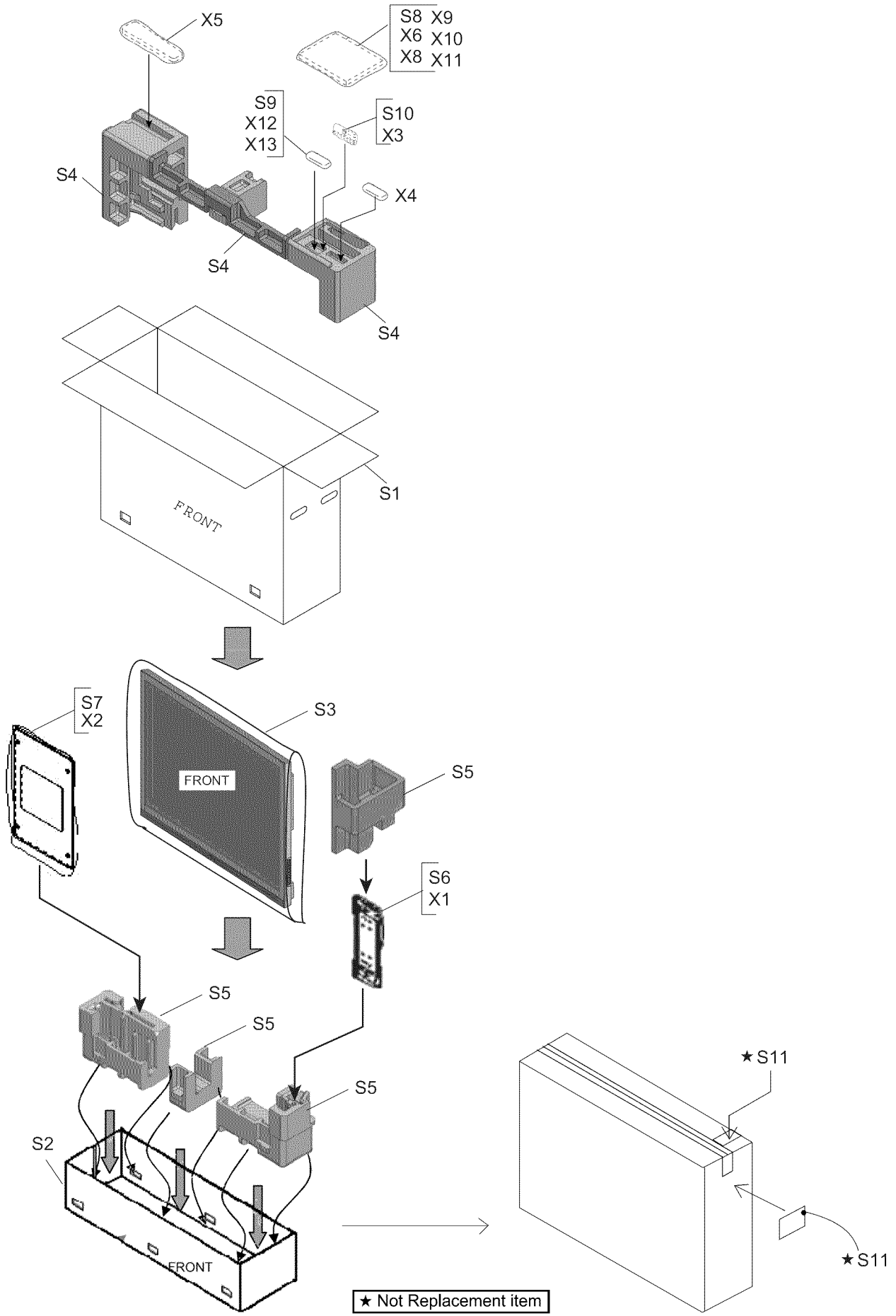

NO.	PARTS CODE	PRICE RANK	NEW MARK	PART DELIVERY	DESCRIPTION
<b>[6] PACKING PARTS (NOT REPLACEMENT ITEM) (LC-52LE920UN)</b>					
S1	SPAKCF913WJZZ	-	N	-	Packing Case
S2	SPAKCF474WJZZ	-		-	Bottom Case
S3	SPAKPA992WJZZ	-		-	Wrapping Paper
S4	SPAKXC910WJZZ	-		-	Packing Add. (Top)
S5	SPAKXC915WJZZ	-		-	Packing Add. (Bottom)
S6	Not Available	-	N	-	Wrapping Paper
S7	Not Available	-		-	Wrapping Paper
S8	SSAKA0101GJZZ	-		-	Polyethylene Bag
S9	SSAKAA032WJZZ	-		-	Polyethylene Bag
S10	SSAKA008WJZZ	-	N	-	Polyethylene Bag
S11	TLABKA009WJZZ	-		-	Case No. Label

[7] PACKING PARTS (NOT REPLACEMENT ITEM) (LC-60LE920UN)

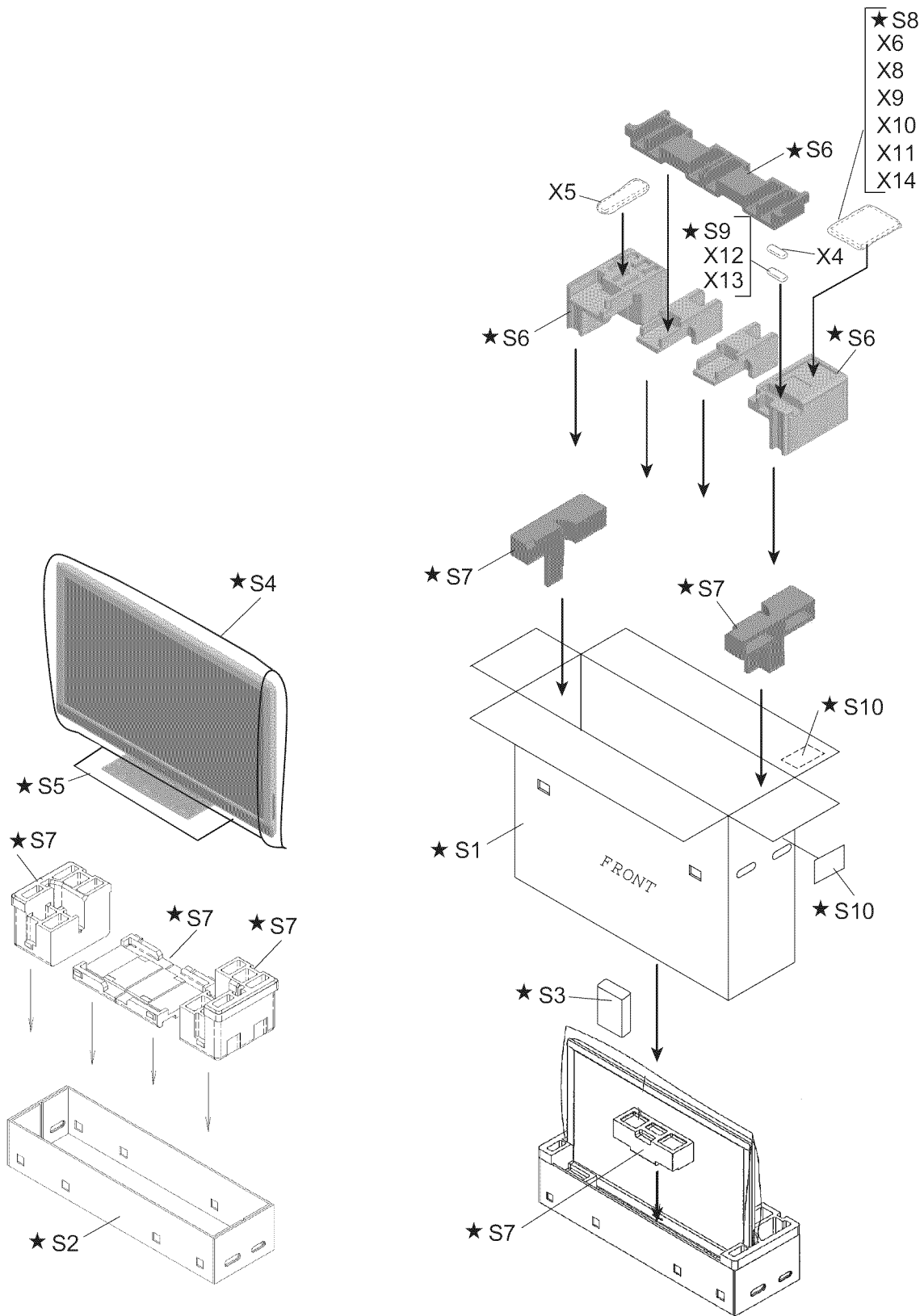

★ Not Replacement item

NO.	PARTS CODE	PRICE RANK	NEW MARK	PART DELIVERY	DESCRIPTION
<b>[7] PACKING PARTS (NOT REPLACEMENT ITEM) (LC-60LE920UN)</b>					
S1	SPAKCF782WJZZ	-	N	-	Packing Case
S2	SPAKCF475WJZZ	-		-	Bottom Case
S3	SPAKAA625WJZZ	-		-	Packing Add. (Rear)
S4	SPAKPB427WJZZ	-	N	-	Wrapping Paper
S5	SPAKPB518WJZZ	-		-	Wrapping Paper
S6	SPAKXC911WJZZ	-		-	Packing Add. (Top)
S7	SPAKXC916WJZZ	-		-	Packing Add. (Bottom)
S8	SSAKA0101GJZZ	-		-	Polyethylene Bag
S9	SSAKAA032WJZZ	-		-	Polyethylene Bag
S10	TLABKA009WJZZ	-		-	Case No. Label
<b>[8] SERVICE JIGS (USE FOR SERVICING)</b>					
N	QCNW-C222WJQZ	AW		J	Connecting Cord L=1000mm 80pin LCD Control Unit to LCD Panel Unit, x2
N	QCNW-H184WJQZ	AX		J	Connecting Cord L=1000mm 12pin Main to Power Unit (PD)
N	QCNW-F676WJQZ	BH		J	Connecting Cord L=1000mm 41pin Main to LCD Control Unit (LW)
N	QCNW-G405WJQZ	AP		J	Connecting Cord L=1000mm 4pin Main to LCD Control Unit (PL)
N	QCNW-G394WJQZ	AV		J	Connecting Cord L=1000mm 9pin Main to LED Drive Unit (LB)
N	QCNW-K593WJQZ		N	J	Connecting Cord L=1000mm 13pin Power to LED Drive Unit (LA)

# SHARP

**COPYRIGHT © 2010 BY SHARP CORPORATION**

**ALL RIGHTS RESERVED.**

No Part of this publication may be reproduced, stored in a retrieval system, or transmitted in any form or by any means, electronic, mechanical, photocopying, recording, or otherwise, without prior written permission of the publisher.



## Free Manuals Download Website

<http://myh66.com>

<http://usermanuals.us>

<http://www.somanuals.com>

<http://www.4manuals.cc>

<http://www.manual-lib.com>

<http://www.404manual.com>

<http://www.luxmanual.com>

<http://aubethermostatmanual.com>

Golf course search by state

<http://golfingnear.com>

Email search by domain

<http://emailbydomain.com>

Auto manuals search

<http://auto.somanuals.com>

TV manuals search

<http://tv.somanuals.com>