

# SHARP®

HI FI-KOMPONENTEN-SYSTEM  
SYSTÈME HI FI  
SISTEMA HI FI COMPONENTE  
HI FI KOMPONENT SYSTEM  
HI FI SISTEMI  
HI FI SYSTEEM  
SISTEMA DE COMPONENTE HI FI  
HI FI-KOMPONENTTIJÄRJESTELMÄ  
ZESTAW HI-FI  
HI FI COMPONENT SYSTEM

MODELL  
MODÈLE  
MODELO  
MODELL  
MODELLO

MODEL  
MODELO  
MALLI  
MODEL  
MODEL

## XL-HF151PH(S) XL-HF151PH(BK)

BEDIENUNGSANLEITUNG  
MODE D'EMPLOI  
MANUAL DE MANEJO  
BRUKSANVISNING  
MANUALE DI ISTRUZIONI

GEBRUIKSAANWIJZING  
MANUAL DE OPERAÇÃO  
KÄYTTÖOHJE  
INSTRUKCJA OBSŁUGI  
OPERATION MANUAL



Made for



iPod



iPhone



iPad

iPhone, iPod, iPod classic, iPod nano, and iPod touch are trademarks of Apple Inc., registered in the U.S. and other countries. iPad is a trademark of Apple Inc.



**MP3**



DEUTSCH	...	Siehe Seiten i bis x und D-1 bis D-22.
FRANÇAIS	...	Se reporter aux pages i à x et F-1 à F-22.
ESPAÑOL	...	Consulte las páginas i a x y S-1 a S-22.
SVENSKA	...	Hänvisa till sidorna i till x och V-1 till V-22.
ITALIANO	...	Leggere le pagine i a x e I-1 a I-22.
NEDERLANDS	...	Raadpleeg de bladzijden i t/m x en N-1 t/m N-22.
PORTUGUÊS	...	Favor consultar as páginas i a x e P-1 a P-22.
SUOMI	...	Sivut i - x sekä SU-1 - SU-22.
POLSKI	...	Patrz strony od i do x i od 1 PL-1 do PL-22.
ENGLISH	...	Please refer to pages i to x and E-1 to E-22.

**BESONDERE ANMERKUNGEN**  
**REMARQUES SPÉCIALES**  
**NOTAS ESPECIALES**  
**SÄRSKILDA ANMÄRKNINGAR**  
**NOTE PARTICOLARI**  
**BIJZONDERE OPMERKINGEN**  
**NOTAS ESPECIAIS**  
**ERITYISHUOMAUTUS**  
**WAŻNE INFORMACJE**  
**SPECIAL NOTES**

● **Dichiarazione di conformità**  
 La società SHARP ELECTRONICS EUROPE GmbH dichiara che il prodotto SHARP HI FI SISTEMI XL-HF151PH(S) e XL-HF151PH(BK) è costruito in conformità alle prescrizioni del D.M.no 548 del 28/8/95, pubblicato sulla G.U.no 301 del 28/12/95 ed in particolare è conforme a quanto indicato nell'art. 2, comma 1 dello stesso decreto.

● Bei Einstellung der ON/STAND-BY-Taste auf STAND-BY ist die Netzspannung immer noch im Gerät vorhanden.  
 Wenn die ON/STAND-BY-Taste auf STAND-BY eingestellt wird, kann das Gerät unter Verwendung der Timer-Betriebsart oder Fernbedienung in Betrieb gesetzt werden.  
**Warnung:**  
 In diesem Gerät sind keine vom Benutzer wartbaren Teile vorhanden. Niemals Abdeckungen entfernen, außer wenn Sie dafür qualifiziert sind. In diesem Gerät sind gefährliche Spannungen vorhanden. Vor Ausführung von irgendwelchen Kundendienstarbeiten oder bei längerer Nichtverwendung des Gerätes stets den Netzstecker aus der Netzsteckdose ziehen.

● Lorsque la touche ON/STAND-BY est mise en STAND-BY, l'appareil est toujours sous tension.  
 Lorsque la touche ON/STAND-BY se trouve sur la position STAND-BY, l'appareil est prêt à fonctionner par la minuterie ou la télécommande.  
**Avertissement:**  
 Cet appareil contient des pièces non réparables par l'utilisateur. Personne non qualifiée n'enlèvera jamais les couvercles. L'appareil contenant des organes portés à haute tension, débrancher l'appareil avant toute réparation ou en période de non-utilisation.

● Cuando el botón ON/STAND-BY está puesto en la posición STAND-BY, todavía hay tensión dentro del aparato.  
 Cuando el botón ON/STAND-BY está puesto en la posición STAND-BY, el aparato puede ponerse en funcionamiento utilizando el modo del temporizador o el controlador remoto.  
**Advertencia:**  
 Tenga en cuenta que dentro de este aparato no hay piezas que pueda reparar. No quite nunca las tapas a menos que se esté cualificado para hacerlo. Este aparato tiene en su interior tensiones peligrosas. Desenchufe siempre la clavija de la red del tomacorriente antes de realizar cualquier servicio de mantenimiento y cuando no se use el aparato durante un largo período de tiempo.

● När ON/STAND-BY knappen är i läge STAND-BY, finns nätspänning i apparaten.  
 Med ON/STAND-BY knappen i läge STAND-BY kan apparaten startas med timerfunktion eller fjärrkontrollen.  
**Varning:**  
 Apparaten innehåller inga delar som kan åtgärdas av kunden. Höljet får endast öppnas av kvalificerad personal. Apparaten innehåller farliga spänningar. Stickkontakten ska därför dras ut från nätuttaget före reparationsarbeten och bör dras ut om apparaten inte ska användas på mycket länge.

● Quando il tasto ON/STAND-BY si trova in posizione STAND-BY, all'interno dell'apparecchio c'è ancora la corrente.  
 Se il tasto ON/STAND-BY si trova nella posizione STAND-BY, l'unità può essere accesa con il modo timer o con il telecomando.

**Avvertenza:**  
 L'apparecchio non contiene parti riparabili dall'utente. Non togliere mai i coperchi, a meno di non essere qualificati per farlo. All'interno dell'apparecchio ci sono tensioni pericolose, per cui si deve sempre staccare la spina del cavo d'alimentazione dalla presa di corrente prima di qualsiasi intervento di manutenzione e quando non si usa l'apparecchio per un lungo periodo di tempo.

● Wanneer de ON/STAND-BY toets in de STAND-BY stand staat, loopt er nog steeds stroom (netspanning) in het toestel.  
 Wanneer de ON/STAND-BY toets in de STAND-BY stand staat, kan het toestel ingeschakeld worden via de timerfunctie of de afstandsbediening.  
**Waarschuwing:**  
 Dit toestel bevat geen door de gebruiker te repareren onderdelen. Verwijder de behuizing nooit tenzij u deskundig bent op dit gebied. In het toestel loopt een gevaarlijke spanning; haal de stekker altijd uit het stopcontact alvorens onderhouden uit te voeren of wanneer het toestel voor langere tijd niet gebruikt wordt.

● Quando o botão ON/STAND-BY estiver ajustado na posição STAND-BY, a voltagem de alimentação ainda se encontra presente dentro do aparelho.  
 Quando o botão ON/STAND-BY estiver ajustado na posição STAND-BY, o aparelho pode ser colocado em operação através do modo de programação horária ou pelo controle remoto.  
**Advertência:**  
 Neste aparelho não há partes que podem ser consertadas pelo usuário. Nunca retire a tampa, a menos que você tenha qualificação para tal. Este aparelho contém voltagens perigosas. Remova sempre o cabo de alimentação da tomada antes de efetuar qualquer conserto ou quando deixar o aparelho muito tempo fora de uso.

● Kun ON/STAND-BY -kytkin on STAND-BY-asennossa, laitteessa on yhä virta.  
 Kun ON/STAND-BY -kytkin on STAND-BY-asennossa, laite voidaan kytkeä päälle kaukosäätimestä.  
**Varoitus:**  
 Laitteen sisällä ei ole käyttäjän huollettavissa olevia osia. Koteloa saa irrottaa vain siihen pätevytynyt henkilö. Laitteen sisällä on vaarallinen jännite. Laite on aina irrotettava verkkovirrasta ennen huoltotoimenpiteitä ja jos laite on pitkään käyttämättä.

● Gdy urządzenie znajduje się w trybie czuwania, jego wewnętrzne elementy są pod napięciem.  
 Gdy urządzenie znajduje się w trybie czuwania, może zostać włączone przy pomocy zegara lub pilota.  
**Ostrzeżenie:**  
 Wewnętrzne urządzenia nie ma żadnych elementów wymagających obsługi użytkownika. Obudowa może być zdejmowana wyłącznie przez wykwalifikowanych pracowników serwisu. Wewnętrzne elementy urządzenia znajdują się pod napięciem. Przed zdjęciem obudowy, lub gdy urządzenie ma zostać przez dłuższy czas nieużywane, należy wyjąć wtyczkę z gniazdka elektrycznego.

● When the ON/STAND-BY button is set at STAND-BY position, mains voltage is still present inside the unit.  
 When the ON/STAND-BY button is set at STAND-BY position, the unit may be brought into operation by the timer mode or remote control.  
**Warning:**  
 This unit contains no user serviceable parts. Never remove covers unless qualified to do so. This unit contains dangerous voltages, always remove mains plug from the socket before any service operation and when not in use for a long period.

- Når ON/STAND-BY-knappen er sat i STAND-BY positionen, er der stadig netspænding til stede i apparatet. Når ON/STAND-BY-knappen er sat i STAND-BY position, kan apparatet startes v.h.j.a. timer-funktionen eller fjernbetjeningen.  
**Advarsel:**  
Apparatet indeholder ingen dele, der kan repareres af brugeren selv. Fjern aldrig kabinettet med mindre De er kvalificeret hertil. Apparatet indeholder farlig strømspænding. Træk altid stikket ud af stikkontakten før der foretages reparationer, eller hvis apparatet ikke er i brug i længere tid.

**PŘED SEJMUTÍM KRYTU NUTNO VYJMOUT VIDLICI ZE SÍŤOVÉ ZÁSUVKY.**

**PRED ZLOŽENÍM KRYTU JE NUTNÉ ODPOJIT PRÍSTROJ ZO SIETE.**

**DENNA APPARAT ÄR ANSLUTEN TILL 230 V VÄXELSTRÖM NÄR STICKPROPPEN ÄR INSKJUTEN I VÄGGUTTAGET. FÖR ATT FULLSTÄNDIGT KOPPLA IFRÅN APPARATEN, V.G. DRAG UT STICKPROPPEN.**

- Audio-visuelles Material kann Urheberrechte umfassen, die ohne Genehmigung des Eigentümers dieser Urheberrechte nicht aufgenommen werden dürfen. Siehe die entsprechenden nationalen Gesetze.
- Le matériel audio-visuel peut comporter des oeuvres faisant l'objet de droits d'auteur qui ne peuvent être enregistrées sans l'autorisation du possesseur du droit d'auteur, veuillez vous référer aux réglementations nationales en vigueur.
- El material audiovisual puede consistir en trabajos que tengan derechos de autor y que no deben grabarse sin la autorización del poseedor de dichos derechos de autor. Sírvase consultar las leyes aplicables en su país.
- Audiovisuellt material kan innehålla upphovsrättsarbete som inte skall mångfaldigas utan tillstånd av copyrightinnehavaren. Se den tillämpliga lagen i ditt land.
- Il materiale audio-visivo che fosse soggetto a copyright non può essere registrato senza l'autorizzazione del possessore del copyright. Si prega di attenersi alle leggi in vigore sul territorio nazionale.
- Audio-visueel materiaal kan worden beschermd door auteursrechten, in welk geval het niet mag worden opgenomen zonder de toestemming van de auteursrechtshouder. Zie voor nadere informatie de betreffende wetten in het land van gebruik.
- O material audiovisual pode consistir de trabalhos de direitos autorais que não devem ser gravados sem autorização do proprietário dos direitos. Favor consultar as leis vigentes em seu país.
- Audiovisuaalinen materiaali saattaa olla tekijänoikeudella suojattua, eikä sitä tällöin saa tallentaa ilman tekijänoikeuden haltijan lupaa. Lisätietoja on maassasi sovellettavassa tekijänoikeuslaissa.

- Materiał audiowizualny może zawierać utwory chronione prawem autorskim, które nie mogą być nagrywane bez zgody właściciela praw autorskich. Patrz odpowiednie regulacje prawne w danym kraju
- Audio-visual material may consist of copyrighted works which must not be recorded without the authority of the owner of the copyright. Please refer to relevant law in your country.

- **Vorsicht:**  
Das Gerät weder Tropf- noch Spritzwasser aussetzen. Ansonsten besteht die Gefahr eines Brandes oder elektrischen Schlages. Es dürfen keine mit Flüssigkeiten gefüllten Gegenstände wie Vasen auf dem Gerät abgestellt werden.

- **Attention:**  
Pour éviter un incendie ou une secousse électrique, mettre l'appareil à l'abri de l'eau (éclaboussure, goutte). Ne pas poser sur l'appareil un récipient contenant du liquide.

- **Advertencia:**  
Para evitar incendios y descargas eléctricas, no exponga el aparato a goteo o salpicadura de líquidos. No deberán ponerse encima del aparato objetos que estén llenos de líquido, como por ejemplo un florero.

- **Varning:**  
Utsätt inte enheten för dropp eller stänk för att förhindra brand eller elektriska stötar. Inga vätskefyllda föremål såsom vasor får placeras på enheten.

- **Attenzione:**  
Per prevenire incendi o scosse elettriche, non fare gocciolare nessun liquido sull'apparecchio e non bagnarlo. Non collocarvi sopra nessun oggetto riempito d'acqua, come per esempio vasi.

- **Waarschuwing:**  
Stel het toestel niet bloot aan druipend of spattend water om brand en elektrische schokken te voorkomen. Met vloeistoffen gevulde voorwerpen, zoals vazen, mogen niet op het toestel geplaatst worden.

- **Cuidado:**  
Para evitar incêndio ou choque elétrico, não exponha este aparelho a gotejamento ou salpicamento de água. Não coloque objetos com água como, por exemplo, um vaso de flores, em cima do aparelho.

- **Varoitus:**  
Tulipaloon tai sähköiskun välttämiseksi laitetta ei saa altistaa tippuvalle tai roiskuvalle vedelle. Nestettä sisältäviä astioita kuten esim kukkamaljakkoita ei saa asettaa laitteen päälle.

- **Ostrzeżenie:**  
Żeby zapobiec niebezpieczeństwu pożaru lub porażeniu prądem, urządzenie należy chronić przed zalaniem lub wilgocią. Na urządzeniu nie wolno ustawiać żadnych zbiorników z wodą - np. wazonów.

- **Warning:**  
To prevent fire or shock hazard, do not expose this appliance to dripping or splashing. No objects filled with liquids, such as vases, shall be placed on the apparatus.

<p>● <b>Advarsel:</b> Til at forbygge ild og stød risiko, lad vaere med at undsaette denne indretning for drypning eller overstaenkning. Der ma ikke anbringes nogen genstande fyldt med vand, som for eksempel vaser, pa dette apparat.</p>
<p>● <b>Advarsel:</b> For a unnga brann eller kortslutning, utsett ikke produktet for vann eller fuktighet. Gjenstander som inneholder vaeske, feks. en blomstervase, ma ikke plasseres oppa apparatet.</p>
<p>● <b>Varoitus:</b> Ala vie laitetta sateeseen tai kosteisiin tiloihin. Jos laite on kostunut, anna sen kuivua ennen kuin kaytat sita verkkovirralla. Nestetta sisaltavia astioita kuten esim. kukkamaljakoita ei saa asettaa laitteen paalle.</p>

<p><b>PŘÍSTROJ NEVYSTAVUJTE KAPAJÍCÍ NEBO ŠTRÍKAJÍCÍ VODĚ.</b></p>
<p><b>PRÍSTROJ NEVYSTAVUJTE KVAPKAJÚCEJ ALEBO STRIEKAJÚCEJ VODE.</b></p>
<p><b>Urządzenie należy chronić przed zalaniem i wilgocią.</b></p>

<p>● Dieses Produkt ist ein Laserprodukt der Klasse 1.</p>
<p>● Ce produit est classifié comme étant un LASER DE CLASSE 1.</p>
<p>● Este producto está clasificado como un PRODUCTO LÁSER DE CLASE 1.</p>
<p>● Denna produkt klassificeras som KLASS 1 LASERPRODUKT.</p>
<p>● Questo prodotto è classificato come CLASS 1 LASER PRODUCT.</p>
<p>● Dit product is geclassificeerd als een KLASSE 1 LASER PRODUCT.</p>
<p>● Este produto é classificado como PRODUTO LASER DE CLASSE 1.</p>
<p>● Tämä laite on luokiteltu LUOKAN 1 LASERLAITTEEKSI.</p>
<p>● Opisywane urządzenie jest sklasyfikowane jako PRODUKT LASEROWY KLASY 1.</p>
<p>● This product is classified as a CLASS 1 LASER PRODUCT.</p>

<p>● Dette produktet er klassifisert som et KLASSE 1 LASERPRODUKT.</p>
<p>● Dette produkt er klassificeret som et KLASSE 1 LASERPRODUKT.</p>
<p>● Tämä laite on luokiteltu LUOKAN 1 LASERLAITTEEKSI.</p>
<p>● Denna produkt klassificeras som KLASS 1 LASERAPPARAT.</p>
<p>● Tento výrobek je klasifikován jako LASEROVÝ VÝROBEK TŘÍDY 1.</p>
<p>● Tento výrobek je klasifikovaný ako LASEROVÝ VÝROBOK TRIEDY 1.</p>

<p>● <b>VORSICHT</b> Verwendung von Regelungen oder Einstellungen bzw. Durchführung von anderen Verfahren als die hierin angegebenen kann zum Aussetzen gefährlicher Strahlung führen. Da der in diesem Compact Disc Player verwendete Laserstrahl für die Augen schädlich ist, ist das Gehäuse unter keinen Umständen zu zerlegen. Wenden Sie sich für Wartungsarbeiten nur an berechtigten Fachhändler.</p>
<p>● <b>ATTENTION</b> Respecter les indications données relatives à la manipulation, au réglage et au fonctionnement. En cas de non-respect, on s'exposera à une radiation dangereuse. Éviter absolument de démonter l'appareil, qui utilise un rayon laser nuisible aux yeux. Pour toute réparation, s'adresser à une personne qualifiée.</p>
<p>● <b>PRECAUCIÓN</b> El uso de los controles, ajustes o ejecución de procedimientos distintos de los especificados podría causar la exposición a radiación peligrosa. No intente desmontar la caja ya que el haz de láser usado en este reproductor de discos compactos es perjudicial para los ojos. Para el servicio de reparación, consulte a una persona cualificada.</p>
<p>● <b>OBSERVERA</b> Användning av reglage eller justeringar eller handhavande på annat sätt än som anges kan leda till farlig bestrålning. Försök inte ta isär höljet eftersom CD-spelarens laserstråle är skadlig för ögonen. Överlåt service endast till kvalificerad personal.</p>
<p>● <b>ATTENZIONE</b> L'uso dei comandi e l'effettuazione di regolazioni e procedimenti diversi da quelli specificati nel manuale possono provocare una pericolosa esposizione alle radiazioni. Poiché il raggio laser usato in questo giradischi può danneggiare gli occhi, non smontare l'apparecchio. Per le riparazioni rivolgersi a personale specializzato.</p>
<p>● <b>LET OP</b> Gebruik van regelaars, het maken van instellingen, gebruik of handelen anders dan in deze gebruiksaanwijzing vermeld, kan gevaarlijke straling blootleggen. De laserstraal in deze CD-speler kan de ogen beschadigen. Probeer derhalve de ombouw niet te verwijderen. Laat reparaties alleen over aan erkend onderhoudspersoneel.</p>
<p>● <b>CUIDADO</b> O uso de controles, ajustes ou a execução de procedimentos além daqueles especificados aqui pode resultar em perigosa exposição à radiação. Como os raios laser usados neste player de CD são perigosos para os olhos, não tente desmontar o aparelho. Solicite o conserto somente para pessoas especializadas.</p>
<p>● <b>VAROITUS</b> Muiden kuin tässä määriteltyjen ohjaustoimintojen, säätöjen ja toimintojen käyttö saattaa johtaa vaaralliseen säteilyaltistumiseen. Koska tässä cd-soittimessa käytetty lasersäde on silmille vahingollinen, älä pura soittinta. Ainoastaan pätevä henkilökunta saa huoltaa laitetta.</p>

● **OSTRZEŻENIE**

Wykorzystanie elementów sterujących oraz wykonywanie czynności innych niż opisano w niniejszej instrukcji może spowodować narażenie na działanie niebezpiecznego promieniowania.

Ponieważ wiązka lasera zastosowanego w tym odtwarzaczu płyt CD jest niebezpieczna dla oczu, nie wolno samodzielnie demontować obudowy urządzenia. Wszelkie czynności serwisowe należy zlecać osobom wykwalifikowanym.

● **CAUTION**

Use of controls, adjustments or performance of procedures other than those specified herein may result in hazardous radiation exposure.

As the laser beam used in this compact disc player is harmful to the eyes, do not attempt to disassemble the cabinet. Refer servicing to qualified personnel only.

**VÝSTRAHA: VÝROBEK JE VYBAVEN LASEREM. PŘI NESPRÁVNÉ MANIPULACI S PŘÍSTROJEM V ROZPORU S TÝMTO NÁVODEM MŮŽE DOJÍT K NEBEZPEČNÉMU OŽÁŘENÍ. NEOTVÍREJTE A NESNÍMEJTE PROTO ŽÁDNÉ KRYTY A PŘÍSTROJ NEOPRAVUJTE. OPRAVU A SERVIS SVĚŘTE ODBORNÉMU SERVISU.**

**VÝSTRAHA: VÝROBEK JE VYBAVENÝ LASEROM. PRI NESPRÁVNOM MANIPULOVANÍ S PŘÍSTROJOM V ROZPORE S TÝMTO NÁVODOM MŮŽE DŮJSTĚ K NEBEZPEČNÉMU OŽIARENÍU. NEODKRÝVAJTE PRETO ŽIADNE KRYTY A PŘÍSTROJ NEOPRAVUJTE OPRAVU A SERVIS PRENEHAJTE ODBORNÉMU SERVISU.**

Eigenschaften der Laserdiode

Material: AlGaAs  
Wellenlänge: 790 nm  
Emissionsdauer: kontinuierlich  
Laser-Ausgang: max. 0.7 mW

Caractéristiques de la diode laser

Matière: AlGaAs  
Longueur d'onde: 790 nm  
Durée d'émission: ininterrompue  
Puissance de sortie laser maximale: 0.7 mW

Características del diodo láser

Material: AlGaAs  
Longitud de onda: 790 nm  
Duración de emisión: continua  
Salida de láser: máx. 0.7 mW

Laserdiodens egenskaper

Material: AlGaAs  
Våglängd: 790 nm  
Utstrålningsvaraktighet: kontinuerlig  
Lasereffekt: max. 0.7 mW

Proprietà del diodo laser

Materiale: AlGaAs  
Lunghezza d'onda: 790 nm  
Durata di emissione: continua  
Uscita massima del laser: 0.7 mW

Laser diode specificaties

Materiaal: AlGaAs  
Golflengte: 790 nm  
Stralingsduur: doorlopend  
Laseruitgang: max. 0.7 mW

Propriedades do diodo laser

Material: AlGaAs  
Comprimento de onda: 790 nm  
Duração da emissão: contínua  
Saída de laser: máx. 0.7 mW

Laser Diode ominaisuudet

Materiaali: AlGaAs  
Aallonpituus: 790 nm  
Päästöjen kesto: jatkuva  
Laser ulostulo: maksimi 0.7 mW

Laser Diode Properties

Material: AlGaAs  
Wavelength: 790 nm  
Emission Duration: continuous  
Laser Output: max. 0.7 mW

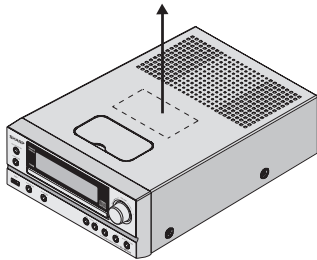
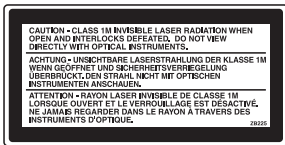

ADVERSEL-SYNLIG OG USYNLIG LASERSTRÅLING VED ÅBNING. SE IKKE IND I STRÅLEN-HELLER IKKE MED OPTISKE INSTRUMENTER.

VARO! AVATTAESSA OLET ALLTAINA NÄKYVÄLLE JA NÄKYMÄTTÖMÄLLE LASERSÄTEILYLLÄ ÄLÄ TUJOTTA SÄTEESEEN ÄLÄKÄ KATSO SITÄ OPTISEN LAITTEEN LÄPI.

VARNING - SYNLIG OG OSYNLIG LASERSTRÅLNING NÄR DENNA DEL ÄR ÖPPNAD. STIRRA EJ IN I STRÅLEN OCH BETRAKTA EJ STRÅLEN GENOM OPTISKT INSTRUMENT.

**VAROITUS! LAITTEEN KÄYTTÄMINEN MUULLA KUIN TÄSSÄ KÄYTTÖOHJEESSA MAINITULLA TAVALLA SAATTAA ALTISTAA KÄYTTÄJÄN TURVALLISUUSLUOKAN 1 YLITTÄVÄLLE NÄKYMÄTTÖMÄLLE LASERSÄTEILYLLÄ.**

**VARNING - OM APPARATEN ANVÄNDS PÅ ANNAT SÄTT ÄN I DENNA BRUKSANVISNING SPECIFICERAS. KAN ANVÄNDAREN UTSÄTTAS FÖR OSYNLIG LASERSTRÅLNING, SOM ÖVERSKRIDER GRÄNSEN FÖR LASERKLASS 1.**

"Made for iPod", "Made for iPhone" och "Made for iPad" innebär att ett elektroniskt tillbehör har designats för att kopplas specifikt till en iPod, iPhone eller iPad och har certifierats av utvecklarer för att tillfredsställa Apples prestandanormer. Apple ansvarar inte för användning av denna apparat eller dess överensstämmelse med säkerhetsnormer och föreskrifter. Observera att användning av detta tillbehör med iPod, iPhone eller iPad kan påverka den trådlösa prestandan.

"Made for iPod", "Made for iPhone" e "Made for iPad" significano che un accessorio elettronico è stato progettato per essere specificamente collegato a iPod, iPhone o iPad, rispettivamente; inoltre, il produttore ne ha certificato la conformità agli standard di funzionamento Apple. Apple non si ritiene responsabile circa il funzionamento del presente dispositivo o la sua conformità con gli standard normativi e relativi alla sicurezza. L'utilizzo di questo accessorio con iPod, iPhone o iPad potrebbe influire sulle prestazioni wireless.

"Made for iPod", "Made for iPhone" en "Made for iPad" betekent dat een elektronische accessoire ontworpen is om specifiek aangesloten te worden op de iPod, iPhone of iPad respectievelijk en gecertificeerd is door de ontwerper om aan de Apple prestatie maatstaven te voldoen. Apple is niet verantwoordelijk voor de werking van dit apparaat of zijn naleving aan veiligheids- en regelgevende maatstaven. Realiseer u, dat het gebruik van dit accessoire een negatieve invloed kan hebben op draadloos gebruik van uw iPod, iPhone of iPad.

A indicação "Made for iPod", "Made for iPhone" e "Made for iPad" significa que um acessório electrónico foi concebido para se ligar especificamente ao iPod, iPhone ou iPad, respectivamente, e foi certificado pelo fabricante para satisfazer os padrões de desempenho da Apple. A Apple não é responsável pelo funcionamento deste aparelho ou pelo cumprimento das normas de segurança e regulamentares. De salientar que o uso deste acessório com o iPod, iPhone ou iPad pode afectar o desempenho sem fios.

"Made for iPod", "Made for iPhone" ja "Made for iPad" tarkoittavat sitä, että elektroninen lisälaitte on suunniteltu nimenomaisesti iPod, iPhone tai iPad. Valmistaja on sertifioinut laitteen niin, että se vastaa Applen standardeja. Apple ei ole vastuussa laitteen toiminnasta tai sen yhdenmukaisuudesta turvallisuus- ja sääntelystandardien kanssa. Huomaa, että tämän lisälaitteen käyttö iPod, iPhone tai iPad kanssa saattaa vaikuttaa langattoman verkon toimintaan.

Oznaczenia "Made for iPod," "Made for iPhone," oraz "Made for iPad" oznaczają, że dane wyposażenie zostało zaprojektowane specjalnie do współpracy z urządzeniem iPod, iPhone lub iPad i posiadają certyfikat producenta na zgodność z normami firmy Apple. Firma Apple nie ponosi odpowiedzialności za działanie tego wyposażenia ani jego zgodności z normami dotyczącymi bezpieczeństwa i innymi przepisami. Należy pamiętać o tym, że użytkowanie niniejszego zestawu z urządzeniem iPod, iPhone lub iPad może niekorzystnie oddziaływać na łączność bezprzewodową.

"Made for iPod," "Made for iPhone," and "Made for iPad" mean that an electronic accessory has been designed to connect specifically to iPod, iPhone, or iPad, respectively, and has been certified by the developer to meet Apple performance standards. Apple is not responsible for the operation of this device or its compliance with safety and regulatory standards. Please note that the use of this accessory with iPod, iPhone, or iPad may affect wireless performance.

„Made for iPod“, „Made for iPhone“ und „Made for iPad“ bedeutet, dass ein elektronisches Zubehörteil speziell für den Anschluss an einen iPod, iPhone oder iPad konzipiert wurde und der Entwickler sich dafür verbürgt, dass das Gerät den Leistungsstandards von Apple entspricht. Apple ist nicht verantwortlich für den Betrieb dieses Gerätes oder dafür, dass es Sicherheits- und Regelungsstandards einhält. Bitte beachten Sie, dass die Nutzung dieses Zubehörteils mit einem iPod, iPhone oder iPad zu einer Beeinträchtigung der drahtlosen Leistung führen kann.

Les termes « Made for iPod », « Made for iPhone » et « Made for iPad » indiquent qu'un accessoire électronique a été spécifiquement conçu pour se raccorder respectivement à un iPod, iPhone ou iPad, et satisfait, sous certification du développeur, aux normes de performance d'Apple. Apple n'est pas responsable de l'emploi de cet appareil ni de sa conformité aux normes réglementaires et de sécurité. Veuillez noter que l'utilisation de cet accessoire avec l'iPod, l'iPhone ou l'iPad peut affecter les performances sans fil.

"Made for iPod", "Made for iPhone" y "Made for iPad" significa que se ha diseñado un accesorio electrónico para conectar específicamente al iPod, iPhone o iPad, respectivamente, y el fabricante ha certificado que cumple con las normas de desempeño de Apple. Apple no se responsabiliza por el funcionamiento de este dispositivo ni por su cumplimiento con las normas de seguridad y regulatorias. Tenga en cuenta que el uso de este accesorio con el iPod, iPhone o iPad puede afectar el funcionamiento del inalámbrico.

## Entsorgungsinformationen



Achtung: Ihr Produkt trägt dieses Symbol. Es besagt, dass Elektro- und Elektronikgerä- te nicht mit dem Haushaltsmüll entsorgt, sondern einem getrennten Rücknahme- system zugeführt werden sollten.

### A. Entsorgungsinformationen für Benutzer aus Privathaushalten 1. In der Europäischen Union

Achtung: Werfen Sie dieses Gerät zur Entsorgung bitte nicht in den normalen Hausmüll!  
Gemäß einer neuen EU-Richtlinie, die die ordnungsgemäße Rücknahme, Behandlung und Verwertung von gebrauchten Elektro- und Elektronikgeräten vorschreibt, müssen elektrische und elektronische Altgeräte getrennt entsorgt werden.

Nach der Einführung der Richtlinie in den EU-Mitgliedstaaten können Privathaushalte ihre gebrauchten Elektro- und Elektronikgeräte nur kostenlos an ausgewiesenen Rücknahmestellen abgeben<sup>\*)</sup>.

In einigen Ländern<sup>\*)</sup> können Sie Altgeräte u.U. auch kostenlos bei Ihrem Fachhändler abgeben, wenn Sie ein vergleichbares neues Gerät kaufen. <sup>\*)</sup> Weitere Einzelheiten erhalten Sie von Ihrer Gemeindeverwaltung.

Wenn Ihre gebrauchten Elektro- und Elektronikgeräte Batterien oder Akkus enthalten, sollten diese vorher entnommen und gemäß örtlich geltenden Regelungen getrennt entsorgt werden.

Durch die ordnungsgemäße Entsorgung tragen Sie dazu bei, dass Altgeräte angemessen gesammelt, behandelt und verwertet werden. Dies verhindert mögliche schädliche Auswirkungen auf Umwelt und Gesundheit durch eine unsachgemäße Entsorgung.

**2. In anderen Ländern außerhalb der EU**  
Bitte erkundigen Sie sich bei Ihrer Gemeindeverwaltung nach dem ordnungsgemäßen Verfahren zur Entsorgung dieses Geräts.

Für die Schädlichen Gebrauchte Elektro- und Elektronikgeräte können kostenlos beim Händler abgegeben werden, auch wenn Sie kein neues Produkt kaufen. Weitere Rücknahmesysteme finden Sie auf der Homepage von [www.swico.ch](http://www.swico.ch) oder [www.sens.ch](http://www.sens.ch).

### B. Entsorgungsinformationen für gewerbliche Nutzer

#### 1. In der Europäischen Union

Wenn Sie dieses Produkt für gewerbliche Zwecke genutzt haben und nun entsorgen möchten:

Bitte wenden Sie sich an Ihren SHARP Fachhändler, der Sie über die Rücknahme des Produkts informieren kann. Möglicherweise müssen Sie die Kosten für die Rücknahme und Verwertung tragen. Kleine Produkte (und kleine Mengen) können möglicherweise bei Ihrer örtlichen Rücknahmestelle abgegeben werden.

Für Spanien: Bitte wenden Sie sich an das vorhandene Rücknahmesystem oder Ihre Gemeindeverwaltung, wenn Sie Fragen zur Rücknahme Ihrer Altgeräte haben.

#### 2. In anderen Ländern außerhalb der EU

Bitte erkundigen Sie sich bei Ihrer Gemeindeverwaltung nach dem ordnungsgemäßen Verfahren zur Entsorgung dieses Geräts.

## Informations sur la mise au rebut correcte



Attention : votre produit comporte ce symbole. Il signifie que les produits électriques et électroniques usagés ne doivent pas être mélangés avec les déchets ménagers généraux. Un système de collecte séparé est prévu pour ces produits.

### A. Informations sur la mise au rebut à l'intention des utilisateurs privés (ménages)

**1. Au sein de l'Union européenne**  
Attention : si vous souhaitez mettre cet appareil au rebut, ne le jetez pas dans une poubelle ordinaire!

Les appareils électriques et électroniques usagés doivent être traités séparément et conformément aux lois en vigueur en matière de traitement, de récupération et de recyclage adéquats de ces appareils.

Suite à la mise en œuvre de ces dispositions dans les Etats membres, les ménages résident au sein de l'Union européenne peuvent désormais ramener gratuitement<sup>\*)</sup> leurs appareils électriques et électroniques usagés sur des sites de collecte désignés.

Dans certains pays<sup>\*)</sup>, votre détaillant reprendra également gratuitement votre ancien produit si vous achetez un produit neuf similaire.

<sup>\*)</sup> Veuillez contacter votre administration locale pour plus de renseignements. Si votre appareil électrique ou électronique usagé comporte des piles ou des accumulateurs, veuillez les mettre séparément et préalablement au rebut conformément à la législation locale en vigueur.

En veillant à la mise au rebut correcte de ce produit, vous contribuerez à assurer le traitement, la récupération et le recyclage nécessaires de ces déchets, et préviendrez ainsi les effets néfastes potentiels de leur mauvaise gestion sur l'environnement et la santé humaine.

#### 2. Pays hors de l'Union européenne

Si vous souhaitez mettre ce produit au rebut, veuillez contacter votre administration locale qui vous renseignera sur la méthode d'élimination correcte de cet appareil.

Suisse : les équipements électriques ou électroniques usagés peuvent être ramené gratuitement au détaillant, même si vous n'achetez pas un nouvel appareil. Pour obtenir la liste des autres sites de collecte, veuillez vous reporter à la page d'accueil du site [www.swico.ch](http://www.swico.ch) ou [www.sens.ch](http://www.sens.ch).

### B. Informations sur la mise au rebut à l'intention des entreprises

**1. Au sein de l'Union européenne**  
Si ce produit est utilisé dans le cadre des activités de votre entreprise et que vous souhaitez le mettre au rebut:

Veuillez contacter votre revendeur SHARP qui vous informera des conditions de reprise du produit. Les frais de reprise et de recyclage pourront vous être facturés. Les produits de petite taille (et en petites quantités) pourront être repris par vos organisations de collecte locales.

Espagne: veuillez contacter l'organisation de collecte existante ou votre administration locale pour les modalités de reprise de vos produits usagés.

#### 2. Pays hors de l'Union européenne

Si vous souhaitez mettre ce produit au rebut, veuillez contacter votre administration locale qui vous renseignera sur la méthode d'élimination correcte de cet appareil.

## Información sobre la eliminación



Atención: su producto está marcado con este símbolo. Significa que los productos eléctricos y electrónicos usados no deberían mezclarse con los residuos domésticos generales. Existe un sistema de recogida independiente para estos productos.

### A. Información sobre eliminación para usuarios particulares

**1. En la Unión Europea**  
Atención: si quiere desechar este equipo, ¡por favor no utilice el cubo de la basura habitual!

Los equipos eléctricos y electrónicos usados deberían tratarse por separado de acuerdo con la legislación que requiere un tratamiento, una recuperación y un reciclaje adecuados de los equipos eléctricos y electrónicos usados.

Tras la puesta en práctica por parte de los estados miembros, los hogares de particulares dentro de los estados de la Unión Europea pueden devolver sus equipos eléctricos y electrónicos a los centros de recogida designados sin coste alguno<sup>\*)</sup>.

En algunos países<sup>\*)</sup> es posible que también su vendedor local se lleve su viejo producto sin coste alguno si Ud. compra uno nuevo similar.

<sup>\*)</sup> Por favor, póngase en contacto con su autoridad local para obtener más detalles.

Si sus equipos eléctricos o electrónicos usados tienen pilas o acumuladores, por favor deseche los por separado con antelación según los requisitos locales. Al desechar este producto correctamente, ayudará a asegurar que los residuos reciban el tratamiento, la recuperación y el reciclaje necesarios, previniendo de esta forma posibles efectos negativos en el medio ambiente y la salud humana que de otra forma podrían producirse debido a una manipulación de residuos inapropiada.

#### 2. En otros países fuera de la Unión Europea

Si desea desechar este producto, por favor póngase en contacto con las autoridades locales y pregunte por el método de eliminación correcto.

Para Suiza: Los equipos eléctricos o electrónicos pueden devolverse al vendedor sin coste alguno, incluso si no compra ningún nuevo producto. Se puede encontrar una lista de otros centros de recogida en la página principal de [www.swico.ch](http://www.swico.ch) o [www.sens.ch](http://www.sens.ch).

### B. Información sobre Eliminación para empresas usuarias

#### 1. En la Unión Europea

Si el producto se utiliza en una empresa y quiere desecharlo: Por favor póngase en contacto con su distribuidor SHARP, quien le informará sobre la recogida del producto. Puede ser que le cobren los costes de recogida y reciclaje. Puede ser que los productos de tamaño pequeño (y las cantidades pequeñas) sean recogidos por sus centros de recogida locales.

Para España: por favor, póngase en contacto con el sistema de recogida establecido o con las autoridades locales para la recogida de los productos usados.

#### 2. En otros países fuera de la Unión Europea

Si desea desechar este producto, por favor póngase en contacto con sus autoridades locales y pregunte por el método de eliminación correcto.

## Information om återvinning



OBS! Produkten är märkt med symbolen ovan. Denna symbol indikerar att elektroniska produkter inte ska kastas i det vanliga hushållsavfallet eftersom det finns ett separat avfallshanterings-system för dem.

### A. Information om återvinning av elektrisk utrustning för hushåll

#### 1. EU-länder

OBS! Kasta inte denna produkt i soporna!  
Förbrukad elektrisk utrustning måste hanteras i enlighet med gällande miljölagstiftning och återvinningsföreskrifter.

I enlighet med gällande EU-regler ska hushåll ha möjlighet att lämna in elektrisk utrustning till återvinningsstationer utan kostnad.<sup>\*)</sup>

I vissa länder<sup>\*)</sup> kan det även hända att man gratis kan lämna in gamla produkter till återförsäljaren när man köper en ny liknande enhet.

<sup>\*)</sup> Kontakta kommunen för vidare information.

Om utrustningen innehåller batterier eller ackumulatörer ska dessa först avlägsnas och hanteras separat i enlighet med gällande miljöföreskrifter.  
Genom att hantera produkten i enlighet med dessa föreskrifter kommer den att tas om hand och återvinnas på tillämpligt sätt, vilket förhindrar potentiella negativa hälso- och miljöeffekter.

#### 2. Länder utanför EU

Kontakta de lokala myndigheterna och ta reda på gällande sorterings- och återvinningsföreskrifter om du behöver göra dig av med denna produkt.

### B. Information om återvinning för företag

#### 1. EU-länder

Gör så här om produkten ska kasseras:  
Kontakta SHARPs återförsäljare för information om hur man går till väga för att lämna tillbaka produkten. Det kan hända att en avgift för transport och återvinning tillkommer. Mindre skrymmande produkter (om det rör sig om ett fåtal) kan eventuellt återlämnas till lokala återvinningsstationer.

#### 2. Länder utanför EU

Kontakta de lokala myndigheterna och ta reda på gällande sorterings- och återvinningsföreskrifter om du behöver göra dig av med denna produkt.

## Informazioni per un corretto smaltimento



### A. Informazioni sullo smaltimento per gli utenti (privati)

#### 1. Nell'Unione europea

Attenzione: Per smaltire il presente dispositivo, non utilizzare il normale bidone della spazzatura!

Le apparecchiature elettriche ed elettroniche usate devono essere gestite a parte e in conformità alla legislazione che richiede il trattamento, il recupero e il riciclaggio adeguato dei suddetti prodotti.

In seguito alle disposizioni attuate dagli Stati membri, i privati residenti nella UE possono conferire gratuitamente le apparecchiature elettriche ed elettroniche usate a centri di raccolta designati\*.

In alcuni paesi\*, anche il rivenditore locale può ritirare gratuitamente il vecchio prodotto se l'utente acquista un altro nuovo di tipologia simile.

\*) Per maggiori informazioni si prega di contattare l'autorità locale competente.

Se le apparecchiature elettriche o elettroniche usate hanno batterie o accumulatori, l'utente dovrà smaltirli a parte preventivamente in conformità alle disposizioni locali.

Lo smaltimento corretto del presente prodotto contribuirà a garantire che i rifiuti siano sottoposti al trattamento, al recupero e al riciclaggio necessari prevenendone il potenziale impatto negativo sull'ambiente e sulla salute umana, che potrebbe derivare da un'adeguata gestione dei rifiuti.

#### 2. In paesi che non fanno parte dell'UE

Se si desidera eliminare il presente prodotto, contattare le autorità locali e informarsi sul metodo di smaltimento corretto.

Per la Svizzera: Le apparecchiature elettriche o elettroniche usate possono essere restituite gratuitamente al rivenditore, anche se non si acquista un prodotto nuovo. Altri centri di raccolta sono elencati sulle homepage di [www.swico.ch](http://www.swico.ch) o di [www.sens.ch](http://www.sens.ch).

### B. Informazioni sullo smaltimento per gli utenti commerciali

#### 1. Nell'Unione europea

Se il prodotto è impiegato a scopi commerciali, procedere come segue per eliminarlo.

Contattare il proprio rivenditore SHARP che fornirà informazioni circa il ritiro del prodotto. Potrebbero essere addebitate le spese di ritiro e riciclaggio. Prodotti piccoli (e quantitativi ridotti) potranno essere ritirati anche dai centri di raccolta locali.

Per la Spagna: Contattare il sistema di raccolta ufficiale o l'ente locale preposto al ritiro dei prodotti usati.

#### 2. In paesi che non fanno parte dell'UE

Se si desidera eliminare il presente prodotto, contattare le autorità locali e informarsi sul metodo di smaltimento corretto.

Attenzione: Il dispositivo è contrassegnato da questo simbolo, che segnala di non smaltire le apparecchiature elettriche ed elettroniche insieme ai normali rifiuti domestici. Per tali prodotti è previsto un sistema di raccolta a parte.

## Informatie over verantwoorde verwijdering



### A. Informatie over afvalverwijdering voor gebruikers (particuliere huishoudens)

#### 1. In de Europese Unie

Let op: Deze apparatuur niet samen met het normale huisafval weggoien! Afgedankte elektrische en elektronische apparatuur moet gescheiden worden ingezameld conform de wetgeving inzake de verantwoorde verwerking, terugwinning en recycling van afgedankte elektrische en elektronische apparatuur.

Na de invoering van de wet door de lidstaten mogen particuliere huishoudens in die lidstaten van de Europese Unie hun afgedankte elektrische en elektronische apparatuur 'kosteloos' naar hiertoe aangewezen inzamelingsinrichtingen brengen\*.

In sommige landen\* kunt u bij de aanschaf van een nieuw apparaat het oude product kosteloos bij uw lokale distributeur inleveren.

\*) Neem contact op met de plaatselijke autoriteiten voor verdere informatie. Als uw elektrische of elektronische apparatuur batterijen of accumulatoren bevat dan moet u deze afzonderlijk conform de plaatselijke voorschriften weggoien.

Let op: Uw product is van dit merkteken voorzien. Dit betekent dat afgedankte elektrische en elektronische apparatuur niet samen met het normale huisafval mogen worden weggegooid. Er bestaat een afzonderlijk inzamelings-systeem voor deze producten.

Door dit product op een verantwoorde manier weg te gooien, zorgt u ervoor dat het afval de juiste verwerking, terugwinning en recycling ondergaat en potentiële negatieve effecten op het milieu en de menselijke gezondheid worden voorkomen die anders zouden ontstaan door het verkeerd verwerken van het afval.

#### 2. In andere landen buiten de Europese Unie

Als u dit product wilt weggoien, neem dan contact op met de plaatselijke autoriteiten voor informatie omtrent de juiste verwijderingsprocedure.

Voor Zwitserland: U kunt afgedankte elektrische en elektronische apparatuur kosteloos bij de distributeur inleveren, zelfs als u geen nieuw product koopt. Aanruilende inzamelingsinrichtingen zijn vermeld op de startpagina van [www.swico.ch](http://www.swico.ch) of [www.sens.ch](http://www.sens.ch).

### B. Informatie over afvalverwijdering voor bedrijven

#### 1. In de Europese Unie

Als u het product voor zakelijke doeleinden heeft gebruikt en als u dit wilt weggoien:

Neem contact op met uw SHARP distributeur die u inlichtingen verschaft over de terugname van het product. Het kan zijn dat u een afvalverwijderingsbijdrage voor de terugname en recycling moet betalen. Kleine producten (en kleine hoeveelheden) kunnen door de lokale inzamelingsinrichtingen worden verwerkt.

Voor Spanje: Neem contact op met de inzamelingsinrichting of de lokale autoriteiten voor de terugname van uw afgedankte producten.

#### 2. In andere landen buiten de Europese Unie

Als u dit product wilt weggoien, neem dan contact op met de plaatselijke autoriteiten voor informatie omtrent de juiste verwijderingsprocedure.



## Informação sobre Eliminação de Produtos

### A. Informações sobre a Eliminação de Produtos para os Utilizadores (particulares)

#### 1. Na União Europeia

Atenção: Se quiser eliminar este equipamento, não o deve fazer juntamente com o lixo doméstico comum!

O equipamento eléctrico e electrónico deve ser tratado separadamente e ao abrigo da legislação aplicável que obriga a um tratamento, recuperação e reciclagem adequados de equipamentos eléctricos e electrónicos usados.

Atenção: O seu produto está identificado com este símbolo. Significa que os produtos eléctricos e electrónicos não devem ser misturados com o lixo doméstico comum. Existe um sistema de recolhas específico para estes produtos.

Após a implementação desta legislação por parte dos Estados-membros, todos os cidadãos residentes na União Europeia poderão entregar o seu equipamento eléctrico e electrónico usado em estações de recolha específicas a título gratuito\*

Em alguns países\* o seu revendedor local também pode recolher o seu equipamento usado a título gratuito na compra de um novo equipamento.

\*Contacte as entidades locais para mais informações.

Se o seu equipamento eléctrico e electrónico usado funcionar a pilhas ou baterias, deverá eliminá-las em separado, conforme a legislação local, e antes de entregar o seu equipamento.

Ao eliminar este produto correctamente estará a contribuir para que o lixo seja submetido aos processos de tratamento, recuperação e reciclagem adequados. Desta forma é possível evitar os efeitos nocivos que o tratamento inadequado do lixo poderia provocar no ambiente e na saúde.

#### 2. Em outros Países fora da UE

Se quiser eliminar este produto, contacte as entidades locais e informe-se sobre o método correcto para proceder à sua eliminação.

Na Suíça: O equipamento eléctrico e electrónico é aceite, a título gratuito, em qualquer revendedor, mesmo que não tenha adquirido um novo produto. Poderá encontrar uma lista das estações de recolha destes equipamentos na página da Web [www.swinfo.ch](http://www.swinfo.ch) ou [www.sens.ch](http://www.sens.ch).

### B. Informações sobre a Eliminação de Produtos para Utilizadores-Empresas

#### 1. Na União Europeia

Se o produto for usado para fins comerciais e quiser eliminá-lo:

Contacte o seu revendedor SHARP que irá informá-lo sobre a melhor forma de eliminar o produto. Poderá ter de pagar as despesas resultantes da recolha e reciclagem do produto. Alguns produtos mais pequenos (e em pequenas quantidades) poderão ser recolhidos pelas estações locais.

Na Espanha: Contacte o sistema de recolhas público ou as entidades locais para mais informações sobre a recolha de produtos usados.

#### 2. Em outros Países fora da UE

Se quiser eliminar este produto, contacte as entidades locais e informe-se sobre o método correcto para proceder à sua eliminação.

## Tietoja laitteen hävittämisestä

### A. Hävitysohjeet käyttäjille (yksityiset kotitaloudet)

#### 1. Euroopan unionissa

Huomio: Jos haluat hävittää tämän laitteen, älä käytä tavallista jätessäiliötä.

Käytetyt sähkö- ja elektroniikkalaitteet pitää hävittää erikseen noudattaen lainsäädäntöä, joka takaa käytettyjen sähkö- ja elektroniikkalaitteiden oikean käsittelyn, keräämisen ja kierrättämisen.

Jäsenvaltioiden täytäntöönpanoa seuraten yksityiset kotitaloudet EU:n jäsenvaltioissa voivat palauttaa käytetyt sähkö- ja elektroniikkalaitteet määrättyihin keräyspaikkoihin ilmaiseksi\*. Joissakin maissa\*\* paikalliset vähittäismyyjät voivat myös ottaa vastaan vanhan tuotteen ilmaiseksi, jos asiakas ostaa vastaavan uuden tuotteen.

\*) Pyydä lisätietoja paikallisviranomaisilta.  
\*\*) Käytetyissä sähkö- tai elektroniikkalaitteissa käytetään paristoja tai akkuja, hävitä nämä tuotteet erikseen paikallisten säästöjen mukaisesti.

Hävittämällä tuotteen asianmukaisesti, autat varmistamaan, että jätteet käsitellään, kerätään ja kierrätetään asianmukaisella tavalla. Näin välttyään haitallisilta ympäristö- ja terveysvaikutuksilta, joita saattaa olla seuraamuksena jätteen epäasianmukaisesta käsittelystä.

#### 2. Muissa maissa EU:n ulkopuolella

Jos haluat hävittää tuotteen, ota yhteys paikallisiin viranomaisiin ja pyydä ohjeita tuotteen asianmukaiseen hävittämiseen.

### B. Hävitysohjeet yritysikäyttöille

#### 1. Euroopan unionissa

Jos tuotetta on käytetty yrityskäytössä, ja haluat hävittää sen, ota yhteys SHARP-jälleenmyyjään, joka antaa sinulle lisäohjeita tai ottaa tuotteen vastaan. Sinulta saatetaan veloittaa tuotteen vastaanottamisesta ja kierrätyksestä johtuvat kustannukset. Paikalliset keräyspisteet saattavat ottaa vastaan pienet tuotteet (ja pienet määrät).

#### 2. Muissa maissa EU:n ulkopuolella

Jos haluat hävittää tuotteen, ota yhteys paikallisiin viranomaisiin ja pyydä ohjeita tuotteen asianmukaiseen hävittämiseen.



Huomio: Tuote on merkitty tällä symbolilla. Tämä tarkoittaa, että käytettyjä sähkö- ja elektroniikkalaitteita ei saa sekoittaa kotitalouden yleisjätteiden kanssa. Näille tuotteille on olemassa erillinen keräysjärjestelmä.

## Informacje dotyczące usuwania użytego urządzenia



### A. Informacje dla użytkowników (prywatne gospodarstwa domowe) dotyczące usuwania odpadów

#### 1. W krajach Unii Europejskiej

Uwaga: Jeśli chcą Państwo usunąć to urządzenie, prosimy nie używać zwykłych pojemników na śmieci!

Zużyty sprzęt elektryczny i elektroniczny należy usuwać oddzielnie, zgodnie z wymogami prawa dotyczącymi odpowiedniego przetwarzania, odzysku i recyklingu użytego sprzętu elektrycznego i elektronicznego.

Uwaga: Państwa produkt oznaczony jest tym symbolem.

Oznacza to, że użytego sprzętu elektrycznego i elektronicznego nie należy łączyć z odpadami z gospodarstw domowych. Dla tego typu produktów istnieje

odrębny system zbiórki odpadów.

Po wdrożeniu przepisów unijnych w Państwach Członkowskich prywatne gospodarstwa domowe na terenie krajów UE mogą bezpłatnie zwracać zużyty sprzęt elektryczny i elektroniczny do wyznaczonych punktów zbiórki odpadów. W niektórych krajach można bezpłatnie zwrócić stary produkt do lokalnych punktów sprzedaży detalicznej pod warunkiem, że zakupią Państwo podobny nowy produkt.

\*) W celu uzyskania dalszych informacji na ten temat należy skontaktować się z lokalnymi władzami.

Jeśli zużyty sprzęt elektryczny i elektroniczny jest wyposażony w baterie lub akumulatory, należy je usunąć oddzielnie, zgodnie z wymogami lokalnych przepisów.

Jeśli ten produkt zostanie usunięty we właściwy sposób, pomogą Państwo zapewnić, że odpady zostaną poddane przetworzeniu, odzyskowi i recyklingowi, a tym samym zapobiec potencjalnym negatywnym skutkom dla środowiska naturalnego i zdrowia ludzkiego, które w przeciwnym razie mogłyby mieć miejsce na skutek niewłaściwej obróbki odpadów.

#### 2. Kraje pozaunijne

Jeśli chcą Państwo pozbyć się produktu, należy skontaktować się z władzami lokalnymi i uzyskać informacje na temat prawidłowej metody usunięcia produktu.

Dotyczy Szwajcarii: Zużyte urządzenia elektryczne i elektroniczne można zwrócić bezpłatnie do dostawcy, bez konieczności zakupu nowego produktu. Adresy punktów odbioru użytego sprzętu można znaleźć na stronie [www.swico.ch](http://www.swico.ch) lub [www.sens.ch](http://www.sens.ch).

### B. Informacje dla użytkowników biznesowych dotyczące usuwania odpadów

#### 1. W krajach Unii Europejskiej

W przypadku gdy produkt używany jest do celów handlowych i zamierzają go Państwo usunąć:

Należy skontaktować się z dealerem firmy SHARP, który poinformuje o możliwości zwrotu wyrobu. Być może będą Państwo musieli ponieść koszty zwrotu i recyklingu produktu. Produkty niewielkich rozmiarów (i w małej liczbie) można zwrócić do lokalnych punktów zbiórki odpadów.

Dotyczy Hiszpanii: Skontaktuj się z punktem odbioru lub władzami lokalnymi w sprawie oddania używanego produktu.

#### 2. Kraje pozaunijne

Jeśli chcą Państwo usunąć ten produkt, należy skontaktować się z władzami lokalnymi i uzyskać informacje na temat prawidłowej metody jego usunięcia.

## Information on Proper Disposal



### A. Information on Disposal for Users (private households)

#### 1. In the European Union

Attention: If you want to dispose of this equipment, please do not use the ordinary dustbin!

Used electrical and electronic equipment must be treated separately and in accordance with legislation that requires proper treatment, recovery and recycling of used electrical and electronic equipment. Following the implementation by member states, private households within the EU states may return their used electrical and electronic equipment to designated collection facilities free of charge\*.

In some countries\* your local retailer may also take back your old product free of charge if you purchase a similar new one.

\*) Please contact your local authority for further details. If your used electrical or electronic equipment has batteries or accumulators, please dispose of these separately beforehand according to local requirements.

By disposing of this product correctly you will help ensure that the waste undergoes the necessary treatment, recovery and recycling and thus prevent potential negative effects on the environment and human health which could otherwise arise due to inappropriate waste handling.

#### 2. In other Countries outside the EU

If you wish to discard this product, please contact your local authorities and ask for the correct method of disposal.

For Switzerland: Used electrical or electronic equipment can be returned free of charge to the dealer, even if you don't purchase a new product. Further collection facilities are listed on the homepage of [www.swico.ch](http://www.swico.ch) or [www.sens.ch](http://www.sens.ch).

### B. Information on Disposal for Business Users

#### 1. In the European Union

If the product is used for business purposes and you want to discard it:

Please contact your SHARP dealer who will inform you about the take-back of the product. You might be charged for the costs arising from take-back and recycling. Small products (and small amounts) might be taken back by your local collection facilities.

For Spain: Please contact the established collection system or your local authority for take-back of your used products.

#### 2. In other Countries outside the EU

If you wish to discard of this product, please contact your local authorities and ask for the correct method of disposal.

### Informationen zur Batterieentsorgung

Die für dieses Produkt mitgelieferte Batterie kann Spuren von Blei enthalten.

**Für die EU:** Die durchgestrichene Abfalltonne bedeutet, dass gebrauchte Batterien nicht mit dem Haushaltsmüll entsorgt werden sollten! Es gibt getrennte Sammelsysteme für gebrauchte Batterien, welche eine ordnungsgemäße Behandlung und Verwertung entsprechend gesetzlicher Vorgaben erlauben. Weitere Einzelheiten erhalten Sie von Ihrer Gemeindeverwaltung.

**Für die Schweiz:** Die gebrauchte Batterie kann an der Verkaufsstelle zurückgegeben werden.

**Für andere Nicht-EU Staaten:** Bitte erkundigen Sie sich bei Bedarf bei Ihrer Gemeindeverwaltung nach weiteren Informationen zur Entsorgung von gebrauchten Batterien.



Pb

### Information sur la mise au rebut de la pile

Les piles/accus fournies avec ce produit peuvent contenir des traces de Plomb.

**Au sein de l'Union Européenne :** Le symbole de la poubelle sur roues barrée laisse supposer que les piles/accus usagées ne doivent pas être mélangées avec les déchets ménagers! Il existe un mode de collecte séparé pour les piles/accus usagées, ce qui permet d'effectuer un traitement et un recyclage en accord avec la législation. Veuillez contacter une autorité locale pour plus de renseignements sur le système mis en place.

**Pour la Suisse :** Les piles/accus usagées doivent être retournés chez votre détaillant.

**Pour les pays hors Union Européenne :** Veuillez contacter une autorité locale afin de connaître la bonne méthode à utiliser pour la collecte de vos piles/accus usagées.



Pb

### Información sobre la eliminación de la batería

Las baterías suministradas con este producto contienen pequeñas cantidades de Plomo.

**Para EU:** El contenedor de basura con ruedas tachado indica que las baterías usadas no deberían mezclarse con los residuos domésticos generales. Existe un sistema de recogida independiente de baterías usadas, para permitir un correcto tratamiento y reciclado de acuerdo con la legislación vigente. Por favor póngase en contacto con el sistema de recogida establecido o con las autoridades locales para la recogida selectiva de las baterías usadas.

**Para Suiza:** Las baterías usadas deben ser retornadas al punto de venta.

**Para otros países fuera de la Unión Europea:** Por favor póngase en contacto con las autoridades locales para un correcto procedimiento de eliminación de las baterías usadas.



Pb

### Information om batteriavyttring

Batteriet som följer med denna produkt kan innehålla spår av Bly.

**För EU:** Batteriet är märkt med den överkorsade sopkunnan vilket betyder att det inte ska kastas i det vanliga hushållsavfallet. Det finns ett separat insamlingsystem för batterier för att underlätta korrekt behandling och återvinning enligt gällande lagstiftning. Kontakta kommunen för vidare information om insamling och återvinning.

**För Schweiz:** Använda batterier lämnas till inköpsstället.

**För länder utanför EU:** Kontakta de lokala myndigheterna för information om gällande sorterings- och återvinningsföreskrifter om du behöver göra dig av med ett använt batteri.



Pb

### Informazioni sullo smaltimento della batteria

La batteria fornita con questo prodotto contiene tracce di Piombo.

**Per EU:** Il cassonetto barrato indica che le batterie usate non devono essere gettate assieme ai rifiuti domestici! Vi è un sistema di raccolta differenziata per le batterie usate, che consente il loro corretto trattamento e riciclo secondo quanto previsto dalle leggi vigenti. Vi prego di contattare le locali autorità per i dettagli del sistema di raccolta e riciclaggio.

**Per la Svizzera:** Le batterie usate devono essere restituite al punto vendita.

**Per altri Stati non-EU:** Vi prego di contattare le autorità locali per conoscere il metodo corretto di conferimento delle batterie usate.



Pb

### Informatie over afvalverwerking van batterijen

De batterij die bij dit toestel geleverd wordt bevat sporen van Lood.

**Voor EU:** De doorgestreepte vuilnisbak op wieltjes duidt aan dat de gebruikte batterijen niet mogen terechtkomen in het gewone huishoudelijke afval. Er bestaat een gescheiden ophaalsysteem voor deze gebruikte batterijen om eigen behandeling en recyclage volgens de wetgeving toe te laten. Gelieve de lokale autoriteiten te contacteren voor de details van ophaling en recyclage.

**Voor Zwitserland:** De gebruikte batterij moet bij het verkooppunt teruggebracht worden.

**Voor andere niet EU landen:** Gelieve contact op te nemen met uw lokale autoriteiten voor de correcte methode van verwerking van de gebruikte batterijen.



Pb

### Informação sobre Eliminação de Pilhas

A bateria fornecida com este produto contém traços de chumbo.

**Para a União Europeia:** O contenedor de rodas traçado significa que as baterias usadas não deverão ser colocadas junto com o lixo doméstico! Existe um sistema de separação próprio para baterias usadas, para permitir um tratamento e reciclagem própria de acordo com a legislação em vigor. Por favor contacte as autoridades locais para mais detalhes nos esquemas de recolha e reciclagem.

**Para a Suíça:** As baterias usadas deverão ser devolvidas ao ponto de venda.

**Para os outros países fora da União Europeia:** Por favor contacte a sua autoridade local para o método correcto de disposição das baterias usadas.



Pb

### Tietoja paristojen hävittämisestä

Tämän tuotteen mukana oleva paristo/akku saattaa sisältää jäätettä Lyijy.

**EU-maat:** Paristo/akku on merkitty ylliviivatun roskasäiliön symbolilla, mikä tarkoittaa, että sitä ei saa hävittää kotitalouden yleisjätteen kanssa. Paristolle/akulle on olemassa erillinen keräysjärjestelmä, joka helpottaa niiden asianmukaista käsittelyä ja lainnukaista kierrätystä. Ota yhteyttä kuntaviranomaisiin saadaksesi lisätietoa keräyksestä ja kierrätyksestä.

**Sveitsi:** Käytetyt paristot/akut palautetaan ostopaikkaan.

**EU:n ulkopuoliset maat:** Ota yhteyts paikallisviranomaisiin saadaksesi lisätietoa voimassa olevista lajitelu- ja kierrätysäädöksistä ja ohjeet käytetyn pariston/akun hävittämiseen.



Pb

### Informacja na temat usuwania baterii

Bateria dostarczana z tym produktem zawiera śladowe ilości ołowiu.

**W krajach Unii Europejskiej:** Przekreślony pojemnik na odpady oznacza, że zużytych baterii nie należy wyrzucać do pojemników z odpadami domowymi! Dla zużytych baterii istnieje oddzielne systemy zbiórki, które zapewniają prawidłowe przetwarzanie i odzysk zgodnie z obowiązującym prawem. Szczegóły na temat systemów zbiórki otrzymajmy Państwo u lokalnych władz.

**W Szwajcarii:** Zużyte baterie można zwrócić w punkcie sprzedaży. **Kraje pozaunijne:** W celu uzyskania szczegółowych informacji na temat prawidłowej metody postępowania się zużytych baterii, proszę o kontakt z władzami lokalnymi.



Pb

### Information on Battery Disposal

The battery supplied with this product contains traces of Lead.

**For EU:** The crossed-out wheeled bin implies that used batteries should not be put to the general household waste! There is a separate collection system for used batteries, to allow proper treatment and recycling in accordance with legislation. Please contact your local authority for details on the collection and recycling schemes.

**For Switzerland:** The used battery is to be returned to the selling point.

**For other non-EU countries:** Please contact your local authority for correct method of disposal of the used battery.



Pb

# ENGLISH

- XL-HF151PH(S) Hi Fi Component System consisting of XL-HF151PH(S) (main unit) and CP-HF151H (speaker system).
- XL-HF151PH(BK) Hi Fi Component System consisting of XL-HF151PH(BK) (main unit) and CP-HF151H (speaker system).

## Introduction





Thank you for purchasing this SHARP product. To obtain the best performance from this product, please read this manual carefully. It will guide you in operating your SHARP product.

## Special Note

Supply of this product does not convey a license nor imply any right to distribute content created with this product in revenue-generating broadcast systems (terrestrial, satellite, cable and/or other distribution channels), revenue-generating streaming applications (via Internet, intranets and/or other networks), other revenue-generating content distribution systems (pay-audio or audio-on-demand applications and the like) or on revenue-generating physical media (compact discs, digital versatile discs, semiconductor chips, hard drives, memory cards and the like). An independent license for such use is required. For details, please visit <http://mp3licensing.com>  
 MPEG Layer-3 audio coding technology licensed from Fraunhofer IIS and Thomson.

## Accessories

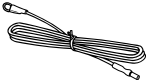
The following accessories are included.

 <p><b>Adaptors for iPhone x 3</b></p>	 <p><b>Remote control x 1</b></p>	 <p><b>"AA" size battery (UM/SUM-3, R6, HP-7 or similar) x 1</b></p>
 <p><b>FM aerial x 1</b></p>	 <p><b>AC power lead x 1</b></p>	 <p><b>Stand for iPad x 1</b></p>

## CONTENTS

	Page		Page
<b>General Information</b>		<b>USB</b>	
Precautions . . . . .	2	Listening to USB mass storage device/MP3 player . . . . .	13
Controls and indicators . . . . .	2 - 3	Advanced USB playback . . . . .	14
<b>Preparation for Use</b>		<b>Radio</b>	
System connections . . . . .	4 - 5	Listening to the radio . . . . .	14 - 15
Remote control . . . . .	5	<b>Advanced Features</b>	
<b>Basic Operation</b>		Using the Radio Data System (RDS) . . . . .	15 - 17
General control . . . . .	6	Timer and sleep operation (Remote control only) . . . . .	18 - 19
Setting the clock (Remote control only) . . . . .	6 - 7	Enhancing your system . . . . .	20
<b>iPod, iPhone and iPad</b>		<b>References</b>	
Listening to the iPod, iPhone or iPad . . . . .	7 - 9	Troubleshooting chart . . . . .	20 - 21
<b>CD or MP3/WMA disc Playback</b>		Maintenance . . . . .	21
Listening to a CD or MP3/WMA disc . . . . .	9 - 10	Specifications . . . . .	22
Advanced CD or MP3/WMA disc playback . . . . .	10 - 11		
MP3/WMA folder mode (only for MP3/WMA files) . . . . .	12		

## Precautions

### General

- Please ensure that the equipment is positioned in a well ventilated area and ensure that there is at least 10 cm (4") of free space along the sides, top and back of the equipment.

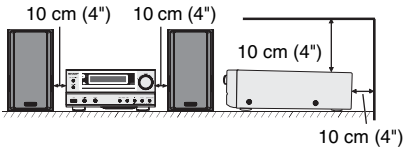

- Use the unit on a firm, level surface free from vibration.
- Place the speakers at least 30 cm (12") away from any CRT TV to avoid colour variations across the TV screen. If the variations persist, move the speakers further away from the TV. LCD TV is not prone to such variation.
- Keep the unit away from direct sunlight, strong magnetic fields, excessive dust, humidity and electronic/electrical equipment (home computers, facsimiles, etc.) which generate electrical noise.
- Do not place anything on top of the unit.
- Do not expose the unit to moisture, to temperatures higher than 60°C (140°F) or to extremely low temperatures.
- If your system does not work properly, disconnect the AC power lead from the wall socket. Plug the AC power lead back in, and then turn on your system.
- In case of an electrical storm, unplug the unit for safety.
- Hold the AC power plug by the head when removing it from the wall socket, as pulling the lead can damage internal wires.

- The AC power plug is used as a disconnect device and shall always remain readily operable.
- **Do not remove the outer cover, as this may result in electric shock. Refer internal service to your local SHARP service facility.**
- The ventilation should not be impeded by covering the ventilation openings with items, such as newspapers, tablecloths, curtains, etc.
- No naked flame sources, such as lighted candles, should be placed on the apparatus.
- Attention should be drawn to the environmental aspects of battery disposal.
- This unit should only be used within the range of 5°C - 35°C (41°F - 95°F).
- The apparatus is designed for use in moderate climates.

### Warning:

The voltage used must be the same as that specified on this unit. Using this product with a higher voltage other than that which is specified is dangerous and may result in a fire or other type of accident causing damage. SHARP will not be held responsible for any damage resulting from use of this unit with a voltage other than that which is specified.

### Volume control

The sound level at a given volume setting depends on speaker efficiency, location, and various other factors. It is advisable to avoid exposure to high volume levels. Do not turn the volume on to full at switch on. Listen to music at moderate levels. Excessive sound pressure from earphones and headphones can cause hearing loss.

## Controls and indicators

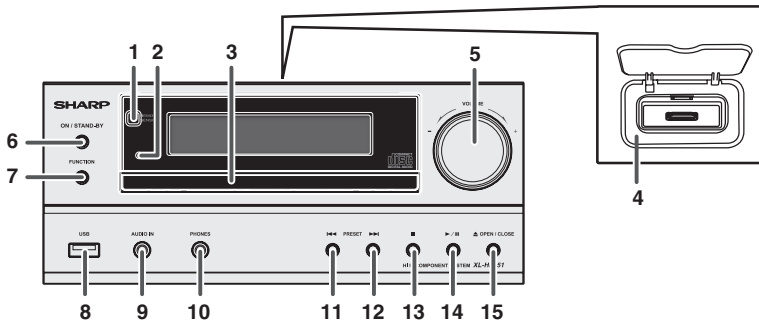

### Front panel

	Page		Page
1. Remote sensor	5	10. Headphone Socket	20
2. Timer indicator	18	11. Tuner Preset Down, CD/USB Track Down, iPod/iPhone Skip Down	9, 10
3. Disc Tray	10	12. Tuner Preset Up, CD/USB Track Up, iPod/iPhone Skip Up	9, 10
4. Docking Station for iPod or iPhone	8	13. Disc/USB Stop Button	10
5. Volume Control	6	14. Disc/USB/iPod/iPhone Play or Pause Button	9, 10
6. On/Stand-by Button	6, 8, 9, 14	15. Disc Tray Open/Close Button	9
7. FUNCTION Button	6, 8, 9, 13, 14		
8. USB Terminal	13		
9. Audio In Socket	20		

# Controls and indicators (continued)

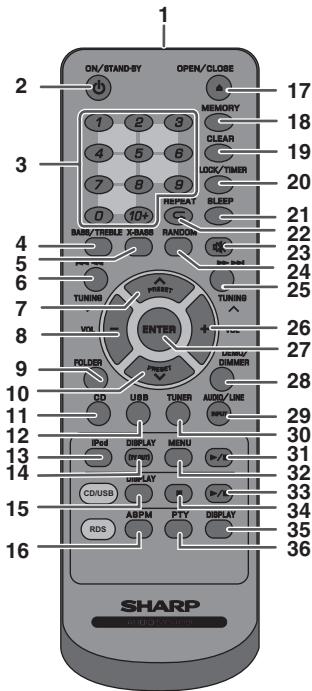

## Remote control

Page

1. Remote Control Transmitter	5
2. On/Stand-by Button	6, 8, 9, 18
3. Numeric Buttons	10
4. Bass/Treble Button	6
5. X-Bass Button	6
6. Tuning Down, Skip Down, Fast Reverse, Time Down Button	6, 9, 12, 14, 18
7. Tuner Preset Up Button, iPod Cursor Up	8, 13, 14
8. Volume Down Button	6
9. Folder Button	12, 13
10. Tuner Preset Down Button, iPod Cursor Down	8, 13, 14
11. CD Button	9
12. USB Button	13
13. iPod Button	8
14. iPod Display (TV OUT) Button	8
15. CD/USB Display Button	12, 13
16. RDS ASPM Button	15
17. Open/Close Button	9
18. Memory Button	10, 14
19. Clear Button	11
20. Clock/Timer Button	6, 18
21. Sleep Button	19
22. Repeat Button	10
23. Mute Button	6
24. Random Button	11
25. Tuning Up, Skip Up, Fast Forward, Time Up Button	6, 9, 12, 14, 18
26. Volume Up Button	6
27. Enter Button	6, 13, 18
28. Demo/Dimmer Button	4, 6
29. Audio/Line (INPUT) Button	5, 20
30. Tuner Button	14
31. iPod Play/Pause Button	8
32. iPod Menu Button	8
33. CD/USB Play/Pause Button	9, 10, 13
34. CD/USB Stop Button	9, 10, 13
35. RDS Display Button	15
36. RDS PTY Button	15

## Display

Page

1. USB Indicator	13
2. iPod Indicators	8
3. CD Indicator	10
4. MP3 Indicator	11
5. WMA Indicator	11
6. RDM (Random) Indicator	11
7. MEM (Memory) Indicator	11
8. Repeat Indicator	10
9. Play/Pause Indicator	10
10. Tuning FM Indicator	15
11. FM Stereo Mode Indicator	15
12. Stereo Station Indicator	15
13. RDS Indicator	15
14. PTY Indicator	15
15. TP Indicator	15
16. TA Indicator	15
17. Muting Indicator	6
18. X-bass Indicator	6
19. Title Indicator	12
20. Artist Indicator	12
21. Folder Indicator	12
22. Album Indicator	12
23. File Indicator	12
24. Track Indicator	12
25. Daily Timer Indicator	18
26. Once Timer Indicator	18
27. Disc Indicator	10
28. Total Indicator	12
29. Sleep Indicator	19

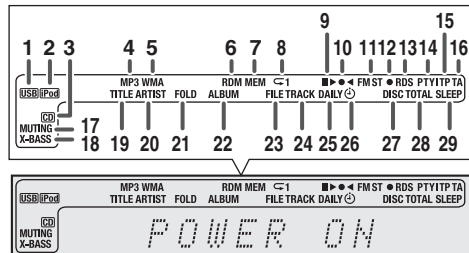

## Speaker system

1. Tweeter
2. Woofer
3. Bass Reflex Duct
4. Speaker Wire

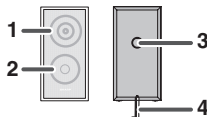

## Speaker grilles are removable

Make sure nothing comes into contact with the speaker diaphragms when you remove the speaker grilles.

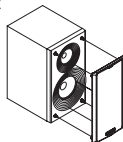



## System connections (continued)

### ■ AC power connection

After checking all the connections have been made correctly, plug the AC power lead of this unit into the wall socket.

#### Note:

Unplug the AC power lead from the wall socket if the unit will not be in use for a prolonged period of time.

### ■ Line input connection (TV, etc.)

Connect to the TV using an audio cable.

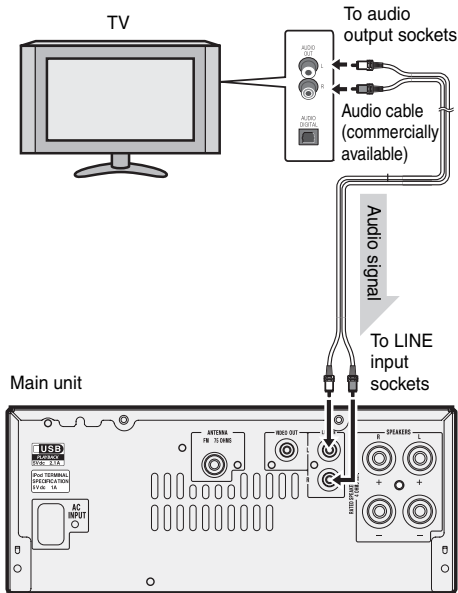

To select Line In function:

- On main unit: Press FUNCTION button repeatedly until Line In is displayed.
- On remote control: Press AUDIO/LINE (INPUT) button repeatedly until Line In is displayed.

## Remote control

### ■ Battery installation

- 1 Open the battery cover.
- 2 Insert the supplied battery according to the direction indicated in the battery compartment.  
When inserting or removing the battery, push it towards the (-) battery terminals.
- 3 Close the cover.

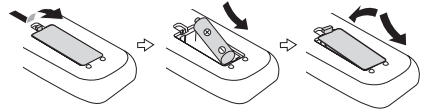

#### Caution:

- Remove the battery if the unit will not be used for a long period of time. This will prevent potential damage due to battery leakage.
- Do not use rechargeable battery (nickel-cadmium battery, etc.).
- Installing the battery incorrectly may cause the unit to malfunction.
- Batteries (battery pack or batteries installed) shall not be exposed to excessive heat such as sunshine, fire or the like.

#### Notes concerning use:

- Replace the battery if the operating distance is reduced or if the operation becomes erratic. Purchase a "AA" size battery (UM/SUM-3, R6, HP-7 or similar).
- Periodically clean the transmitter on the remote control and the sensor on the unit with a soft cloth.
- Exposing the sensor on the unit to strong light may interfere with operation. Change the lighting or the direction of the unit if this occurs.
- Keep the remote control away from moisture, heat, shock, and vibrations.

### ■ Test of the remote control

Check the remote control after checking all the connections. Point the remote control directly at the remote sensor on the unit. The remote control can be used within the range shown below:

Remote sensor

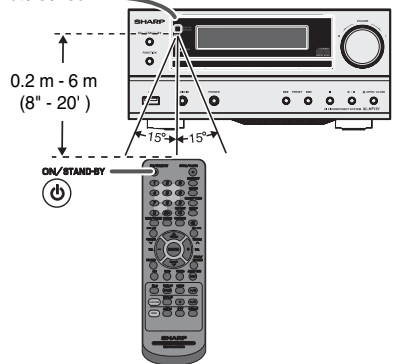



## General control

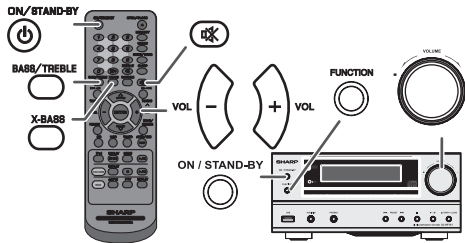

### To turn the power on

Press the ON/STAND-BY button to turn the power on.

#### After use:

Press the ON/STAND-BY button to enter the power stand-by mode.

### Display brightness control

To dim the display brightness, press the DEMO/DIMMER button on the remote control.



### Volume auto set-in

If you turn off and on the main unit with the volume set to 17 or higher, the volume starts at 16.

### Volume control

Turn the volume knob towards VOLUME +/- (on main unit) or press VOL +/- (on remote control) to increase or decrease the volume.

### Auto power on function

When you press any of the following buttons, the unit turns on.

- iPod, CD, USB, AUDIO / LINE (INPUT), TUNER on the remote control: Selected function is activated.
- ►/II button on the main unit: The unit turns on and playback of the last function will start (CD, TUNER, USB, iPod, AUDIO IN, LINE IN)

### Auto power off function

The main unit will enter the stand-by mode (when iPod or iPhone is not docked) after 15 minutes of inactivity during:

- iPod: No connection.
- AUDIO IN / LINE IN: No detection of input signal or very low sound audibility.
- CD / USB: In the stop mode.

#### Note:

However, if iPod or iPhone is docked, the unit will begin charging. "Charge Mode" will be displayed during standby mode.

### Muting

The volume is muted temporarily when pressing the MUTE button on the remote control. Press again to restore the volume.

### X-Bass control

When the power is first turned on, the unit will enter the extra bass mode which emphasises the bass frequencies, and "X-BASS" will appear. To cancel the extra bass mode, press the X-BASS button on the remote control.

### Bass control

- 1 Press the BASS/TREBLE button to select "Bass".
- 2 Within 5 seconds, press the VOLUME (+ or -) button to adjust the bass.



### Treble control

- 1 Press the BASS/TREBLE button to select "Treble".
- 2 Within 5 seconds, press the VOLUME (+ or -) button to adjust the treble.



### Function

When the FUNCTION button on main unit is pressed, the current function will change to different mode. Press the FUNCTION button repeatedly to select desired function.

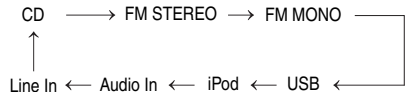

#### Note:

The backup function will protect the memorised function mode for a few hours should there be a power failure or the AC power lead becomes disconnected.

## Setting the clock (Remote control only)

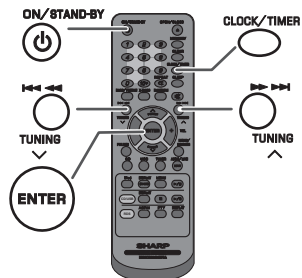

In this example, the clock is set for the 24-hour (00:00) display.

- 1 Press the ON/STAND-BY button to turn the power on.
- 2 Press the CLOCK/TIMER button.
- 3 Within 10 seconds, press the ENTER button. To adjust the day, press the ◀◀◀ or ▶▶▶ button and then press the ENTER button.
- 4 Press the ◀◀◀ or ▶▶▶ button to select 24-hour or 12-hour display and then press the ENTER button.

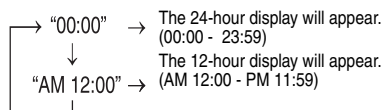

## Setting the clock (Remote control only) (continued)

- To adjust the hour, press the ◀◀◀◀ or ▶▶▶▶ button and then press the ENTER button. Press the ◀◀◀◀ or ▶▶▶▶ button once to advance the time by 1 hour. Hold it down to advance continuously.
- To adjust the minutes, press the ◀◀◀◀ or ▶▶▶▶ button and then press the ENTER button. Press the ◀◀◀◀ or ▶▶▶▶ button once to advance the time by 1 minute.

### To confirm the time display:

Press the CLOCK/TIMER button. The time display will appear for about 5 seconds.

### Note:

When power supply is restored after unit is plugged in again or after a power failure, reset the clock (pages 6 - 7).

### To readjust the clock:

Perform "Setting the clock" from step 2.

### To change the 24-hour or 12-hour display:

Perform "Setting the clock" from step 2 onwards.

## Listening to the iPod, iPhone or iPad

### Made for:

- iPod touch (4<sup>th</sup> generation)
- iPod touch (3<sup>rd</sup> generation)
- iPod touch (2<sup>nd</sup> generation)
- iPod touch (1<sup>st</sup> generation)
- iPod classic
- iPod nano (6<sup>th</sup> generation)
- iPod nano (5<sup>th</sup> generation)
- iPod nano (4<sup>th</sup> generation)
- iPod nano (3<sup>rd</sup> generation)
- iPod nano (2<sup>nd</sup> generation)
- iPhone 4
- iPhone 3GS
- iPhone 3G
- iPhone
- iPad

### Caution:

Please update your iPod, iPhone and iPad unit to the latest software version before using it. Please visit Apple's homepage to download the latest version for your iPod, iPhone and iPad.

### Notes:

- Charging terminal for iPod, iPhone and iPad:

Condition	DOCK	USB
USB function	NO	YES
Other function	YES	NO
Stand-by	YES	NO

- The message "This accessory is not made to work with iPhone" or similar, may appear on the iPhone screen when:
  - battery is low.
  - the iPhone is not properly docked (eg. slanting).
 If this occurs, remove and re-dock the iPhone.
- **This product is made for iPhone. To prevent random interference when iPhone is docked, the headphone output is disabled, and "HP INVALID" will be displayed. You may also experience brief audio interference during incoming calls.**

## ■ iPod, iPhone and iPad connection (USB only)

- Insert the connector to the iPod, iPhone or iPad.

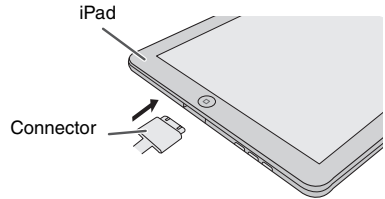

- Place the iPad to the stand for iPad.

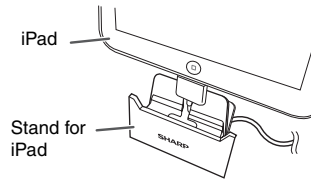

- Connect the iPod, iPhone or iPad to the unit via USB connector.

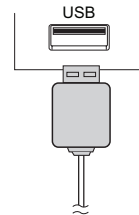

### Note:

USB terminal do not support VIDEO out.

## ■ iPod, iPhone or iPad playback

- Press the ON/STAND-BY button to turn the power on.
- Press the USB button on the remote control or FUNCTION button repeatedly on the main unit to select USB function.
- Connect iPod, iPhone or iPad to the unit. "USB/iPod" will appear.
- Press the ▶/|| (CD/USB ▶/||) button to start playback.

### Note:

Stop button (■) is invalid during iPod, iPhone or iPad playback.

## ■ iPod and iPhone connection (Dock only)

### Note:

Docking station is not recommended for iPad connection.

### Adaptor for iPod and iPhone connection

### Notes:

- Please use the adaptor supplied with your iPod or iPhone unit.
- You can use an audio cable to connect your iPod to the AUDIO IN socket if:
  - your iPod adaptor does not fit into the iPod dock on the main unit.
  - you have an iPod that does not have an iPod adaptor.
  - you have an iPod that does not have an iPod 30 pin connector.

## Listening to the iPod, iPhone or iPad (continued)

Adaptor No.	iPhone Description	Capacity
12	iPhone	4GB & 8GB & 16GB
15	iPhone 3G	8GB & 16GB
15	iPhone 3GS	16GB & 32GB
19	iPhone 4	16GB & 32GB

### To insert adaptor for iPod or iPhone

- 1 Open the docking station for iPod and iPhone by pulling up.

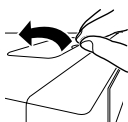

- 2 Insert the adaptor for iPod and iPhone into unit and connect your iPod or iPhone.

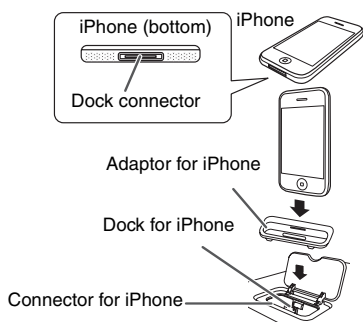

### Caution:

Unplug all accessories from the iPod or iPhone before inserting it into the dock.

### To remove adaptor for iPod or iPhone

Insert the tip of a screwdriver ("-" type, small) into the adaptor hole as shown and lift upward to remove.



### iPod or iPhone playback

- 1 Press the ON/STAND-BY button to turn the power on.
- 2 Press the iPod button on the remote control or FUNCTION button repeatedly on the main unit to select iPod function.
- 3 Insert iPod or iPhone unit in iPod dock of main unit. "Dock Ok" will appear.
- 4 Press the ►/|| (iPod ►/||) button to start playback.

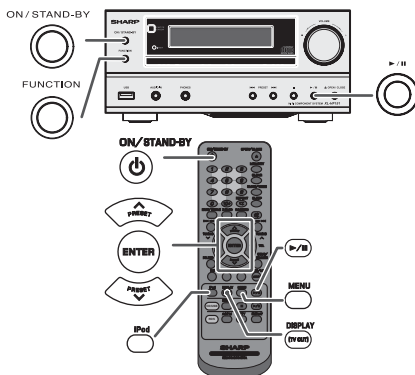

### iPhone playback

- Sound will only switch from iPhone to the main unit after authentication process is completed in approximately 10 seconds.
- Incoming calls will pause the playback.
- Once the calls are answered, the conversation can only be heard through the built-in iPhone speaker. Turn on the iPhone speaker or undock the iPhone to start conversation.

### To disconnect iPod, iPhone or iPad

Simply remove the iPod or iPhone from the docking station or iPad from USB terminal. It is safe to do so even during playback.

### Watching videos on a TV connected to iPod or iPhone

- 1 Press the DISPLAY (TV OUT) button for more than 2 seconds. "TV Display" will appear on display.
- 2 Press the ENTER button to start playback.

### Notes:

- If the TV Out setting is already turned on at video menu, the video is automatically displayed on the TV screen when ENTER key is pressed.
- TV out display is not support through USB terminal. (iPad)
- To return to watching video on iPod or iPhone screen, press the MENU button to enter video menu. Then press the DISPLAY (TV OUT) button for more than 2 seconds until "iPod Display" appears.
- During iPod or iPhone video playback, pressing the DISPLAY (TV OUT) button will not toggle video out display between iPod and TV.

### Caution:

- Unplug all accessories for the iPod or iPhone before inserting it into the docking station.
- Stop button (■) at main unit is invalid during iPod function.

## Listening to the iPod, iPhone or iPad (continued)

### ■ Navigating the iPod, iPhone or iPad menus

- 1 Press the iPod MENU button to view the menu on iPod, iPhone or iPad unit. Press it again to go back to previous menu.
- 2 Use the PRESET (∨ or ∧) button to select an item on the menu and then press ENTER button.

#### Note:

When navigating the iPod, iPhone or iPad menu with remote control, do not operate any of the buttons on the iPod or iPhone unit. The volume level is adjusted by pressing the VOL (+ or -) button on the main unit or the remote control. Adjusting the volume on the iPod, iPhone or iPad units give no effect.

#### iPod, iPhone and iPad operations:

The operations described below depend on the generation iPod, iPhone and iPad you are using.

#### System on operation:

When the main unit is powered on, the iPod, iPhone or iPad units will automatically power on when docked or connected in the unit.

#### System off (stand-by operation):

When the main unit is turned to stand-by mode, the docked iPod, iPhone or connected iPad unit will automatically turn to stand-by mode.

### ■ Various iPod, iPhone and iPad functions

Function	Main unit		Remote control		Operation
	Dock/USB		Dock	USB	
Play			iPod 	CD/USB 	Press in the pause mode.
Pause			iPod 	CD/USB 	Press in the playback mode.
Track up/down					Press in the playback or pause mode. If you press the button in the pause mode, press the ►/   button to start the desired track.
Fast forward/reverse					Press and hold down in the playback mode. Release the button to resume playback.
TV Display	—		iPod DISPLAY (TV OUT)	—	Press for more than 2 seconds to toggle the video out display between iPod or TV.
Repeat	—		REPEAT 	REPEAT 	Press to toggle repeat mode.
Shuffle	—		RANDOM 	RANDOM 	Press to toggle shuffle mode.

Function	Main unit		Remote control		Operation
	Dock/USB		Dock	USB	
Menu	—		iPod MENU 	iPod MENU 	Press to view the iPod menu during iPod function.
Enter	—		ENTER 	ENTER 	Press to confirm the selection.
Cursor Up/Down	—				Press to select in the iPod menu.

## Listening to a CD or MP3/WMA disc

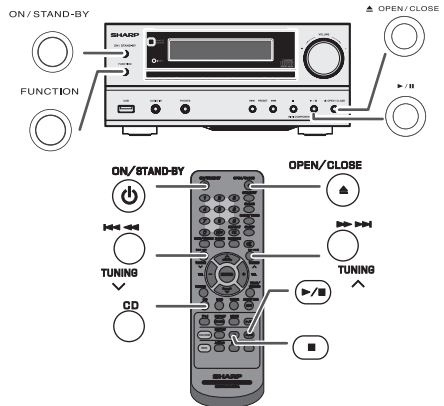

This system can play back a standard CD, CD-R/RW in the CD format and CD-R/RW with MP3 or WMA files, but cannot record on them. Some audio CD-R and CD-RW discs may not be playable due to the state of the disc or the device that was used for recording.

#### MP3:

**MP3 is a form of compression. It is an acronym which stands for MPEG Audio Layer 3. MP3 is a type of audio code which is processed by significant compression from the original audio source with very little loss in sound quality.**

- This system supports MPEG 1 Layer 3 and VBR files.
- During VBR file playback, time counter in the display may differ from its actual playback time.
- Bitrate which is supported by MP3 is 32 ~ 320 kbps.

#### WMA:

**WMA files are Advanced System Format files that include audio files which are compressed with Windows Media Audio codec. WMA is developed by Microsoft as an audio format file for Windows Media Player.**

- "MP3" and "WMA" indicator will light up after the unit reads information on an MP3 or WMA disc.
- Bitrate which is supported by WMA is 64 ~ 160 kbps.

### ■ Disc playback

- 1 Press the ON/STAND-BY button to turn the power on.
- 2 Press the CD button on the remote control or FUNCTION button repeatedly on the main unit to select CD function.
- 3 Press the OPEN/CLOSE button to open the disc tray.
- 4 Place the disc on the disc tray, label side up.

## Listening to a CD or MP3/WMA disc (continued)



- 5 Press the OPEN/CLOSE button to close the disc tray.
- 6 Press the ►/|| (CD/USB ►/||) button to start playback. After the last track is played, the unit will stop automatically.

### Caution:

- Do not place two discs in one disc tray.
- Do not play discs of special shapes (heart, octagon, etc). It may cause malfunctions.
- Do not push the disc tray whilst it is moving.
- If the power fails whilst the tray is open, wait until the power is restored.
- If TV or radio interference occurs during CD operation, move the unit away from the TV or radio.
- Be sure to place 8 cm (3") disc in the middle of the disc tray.
- Due to the structure of the disc information, it takes longer to read an MP3/WMA disc than a normal CD (approximately 20 to 90 seconds).

### Notes for CD or MP3/WMA disc:

Rewritable multi-session discs with unfinished writing, can still be played.

## ■ Various disc functions

Function	Main unit	Remote control	Operation
<b>Play</b> 		CD/USB 	Press in the stop mode.
<b>Stop</b> 		CD/USB 	Press in the playback mode.
<b>Pause</b> 		CD/USB 	Press in the playback mode. Press the ►/   button to resume playback from the paused point.
<b>Track up/down</b> 			Press in the playback or stop mode. If you press the button in the stop mode, press the ►/   button to start the desired track.
<b>Fast forward/reverse</b> 			Press and hold down in the playback mode. Release the button to resume playback.

## Advanced CD or MP3/WMA disc playback

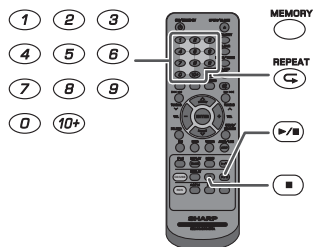

### ■ Direct track search

By using the Numeric buttons, the desired tracks on the current disc can be played.

**Use the Numeric buttons on the remote control to select the desired track whilst playing the selected disc.**

- The Numeric buttons allow you to select up to number 9.
- When selecting number 10 or higher, use the "10+" button.

#### A. For example, to choose 13

- 1 Press the "10+" button once.
- 2 Press the "1" button.
- 3 Press the "3" button.



Selected track number

#### B. For example, to choose 130

- 1 Press the "10+" button twice.
- 2 Press the "1" button.
- 3 Press the "3" button.
- 4 Press the "0" button.

### Notes:

- A track number higher than the number of tracks on the disc cannot be selected.
- During random play, direct search is not possible.

### To stop playback:

Press the ■ (CD/USB ■) button.

### ■ Repeat play

Repeat play can play one track, all tracks or a programmed sequence continuously.

#### To repeat one track:

Press the REPEAT button repeatedly until "Repeat One" appears. Press the ►/|| (CD/USB ►/||) button.

#### To repeat all tracks:

Press the REPEAT button repeatedly until "Repeat All" appears. Press the ►/|| (CD/USB ►/||) button.

#### To repeat desired tracks:

Perform steps 1 - 5 in "Programmed play" section on next page and then press the REPEAT button repeatedly until "Repeat All" appears.

#### To cancel repeat play:

Press the REPEAT button repeatedly until "☞" disappears.

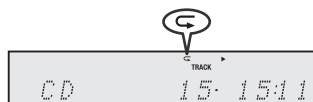

### Caution:

After performing repeat play, be sure to press the ■ (CD/USB ■) button. Otherwise, the disc will play continuously.

### Note:

During repeat play, random play is not possible.

## Advanced CD or MP3/WMA disc playback (continued)

### ■ Random play

The tracks on the disc can be played in random order automatically.

#### To random play all tracks:

Press RANDOM button on the remote control until "Random" appears. Press the ►/II (CD/USB ►/II) button.

#### To cancel random play:

Press the RANDOM button until "RDM" indicator disappears.



#### Notes:

- If you press the ►►►► button during random play, you can move to the track selected next by the random operation. On the other hand, the ◀◀◀◀ button does not allow you to move to the previous track. The beginning of the track being played will be located.
- In random play, the unit will select and play tracks automatically. (You cannot select the order of the tracks.)
- During random play, repeat play is not possible.

### ■ Programmed play (CD)

You can choose up to 32 selections for playback in the order you like.

- 1 Whilst in the stop mode, press the MEMORY button on the remote control to enter the programming save mode.



- 2 Press the ◀◀◀◀ or ►►►► buttons on the remote control to select the desired track.



Selected track number

- 3 Press the MEMORY button to save the track number.
- 4 Repeat steps 2 - 3 for other tracks. Up to 32 tracks can be programmed. If you want to check the programmed tracks, press the MEMORY button repeatedly. If you make a mistake, the programmed tracks can be cleared by pressing the CLEAR button.
- 5 Press the ►/II (CD/USB ►/II) button to start playback.

### ■ Programmed play (MP3/WMA)

- 1 Whilst in the stop mode, press the MEMORY button to enter the programming save mode.



- 2 Press the PRESET (▼ or ▲) button on the remote control to select the desired folder.



Then press the ◀◀◀◀ or ►►►► button on the remote control to select the desired tracks.

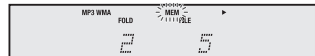

- 3 Press the MEMORY button to save the folder and track number.
- 4 Repeat steps 2 - 3 for other folder/tracks. Up to 32 tracks can be programmed.
- 5 Press the ►/II (CD/USB ►/II) button to start playback.

#### To cancel the programmed play mode:

During programmed stop mode, press the ► (CD/USB ►) button. The display will show "Memory Clear" and all the programmed contents will be cleared.

#### Adding tracks to the programme:

If a programme has been previously stored, the "MEM" indicator will be displayed. Press the MEMORY button. Then follow steps 2 - 3 to add tracks.

#### Notes:

- When a disc is ejected, the programme is automatically cancelled.
- If you press the ON/STAND-BY button to enter the stand-by mode or change the function from CD to another, the programmed selections will be cleared.
- During the programme operation, random play is not possible.

## MP3/WMA folder mode (only for MP3/WMA files)

### To play back MP3/WMA (Windows Media Audio) file

There are many music sites on the internet that you can download MP3/WMA (Windows Media Audio) music files. Follow the instructions from the website on how to download the music files. You can then play back these downloaded music files by burning them to a CD-R/RW disc.

- Your downloaded song/files are for personal use only. Any other usage of the song without owner's permission, is against the law.

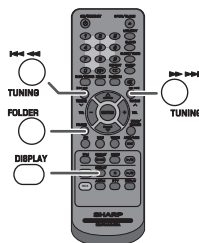

### About folder playback order

If MP3/WMA files are recorded in several folders, a folder number will be set to each folder automatically.

These folders can be selected by the FOLDER button on the remote control. If there is no supported file formats inside the selected folder, the folder is skipped and the next folder will be selected.

Example: How to set folder number if MP3/WMA format files are recorded as below figure.

- ROOT folder is set as folder 1.
  - As for folders inside ROOT folder (Folder A and Folder B), the folder which is recorded earlier on the disc will be set as folder 2 and folder 3.
  - As for folder inside Folder A (Folder C and Folder D), the folder which is recorded earlier on the disc will be set as folder 4 and folder 5.
  - Folder E that is inside Folder D will be set as folder 6.
- The folder and file order information which is recorded on the disc depends on the writing software. There maybe possibilities that this unit will playback the files not according to our expected playback order.
  - For CD MP3/WMA, 99 numbers of folders and 999 files inclusive of the folders which have non playable files can be read.

Folder mode on/off can be operated by the FOLDER button on the remote control. Files that are played when folder mode is set to the on position, may differ from those played back when folder mode is turned off.

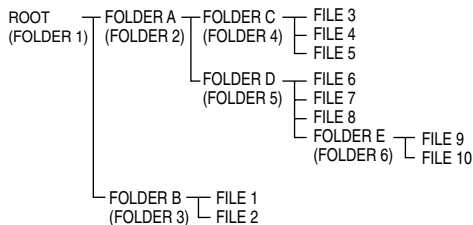

### Procedure to playback MP3/WMA disc with folder mode on

To play back CD-R/RW.

- Press the CD button, and load an MP3/WMA disc. Press the FOLDER button and disc info will be displayed.

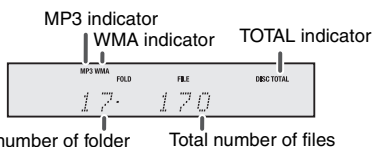

- Press the PRESET (✓ or ^) button to select desired playback folder. (Folder mode on)

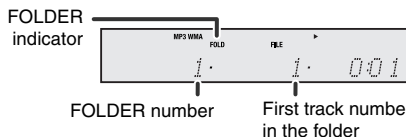

- Select desired file to be played back by pressing the ◀◀◀ or ▶▶▶ button.
- Press the ▶/|| (CD/USB ▶/||) button. Playback will start and file name will be displayed.
  - Title, Artist and Album name are displayed if they are recorded on the disc.
  - In case of playback with the folder mode on, press the PRESET (✓ or ^) button, and the folder can be selected even though it is in playback/pause mode. It will continue playback/pause mode in the 1st track of the selected folder.
  - Display content can be changed by pressing the CD/USB DISPLAY button.

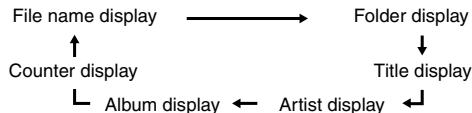

### Note:

If "Not Supported" is displayed, it means "Copyright protected WMA file" or "Not supported playback file" is selected.

# Listening to USB mass storage device/MP3 player

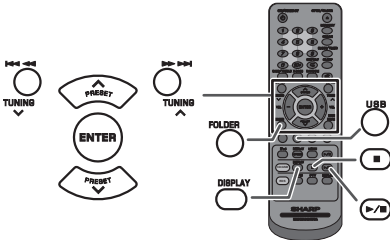
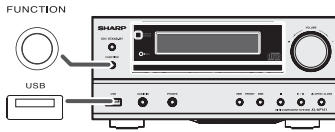

**Note:**

This product is not compatible with MTP and AAC file systems from USB mass storage device or MP3 player.

**■ To play back USB/MP3 player with folder mode off**

- 1 Press the USB button on the remote control or FUNCTION button repeatedly on main unit to select USB function. Connect the USB memory device that has MP3/WMA format files on the unit. When the USB memory is connected to the main unit, the device information will be displayed.

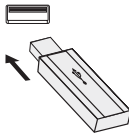

- 2 Select desired file to be played back by pressing the ◀◀◀◀ or ▶▶▶▶ button.
- 3 Press the ▶/|| (CD/USB ▶/||) button. Playback will start and the file name will be displayed.
  - Title, Artist and Album name are displayed if they are recorded in the USB memory device.
  - Display content can be changed by pressing the CD/USB DISPLAY button.

**Note:**

To pause playback:  
Press the ▶/|| (CD/USB ▶/||) button.

**■ To play back USB/MP3 player with folder mode on**

- 1 Press the USB button on the remote control or FUNCTION button repeatedly on main unit to select USB function. Connect the USB memory device that has MP3/WMA format files on the unit. When the USB memory is connected to the main unit, the device information will be displayed.

- 2 Press the FOLDER button, and press the PRESET (∨ or ∧) button to select desired playback folder. To start playback with folder mode on, go to step 4. To change the playback folder, press the PRESET (∨ or ∧) button to select another folder.
- 3 Select desired file to be played back by pressing the ◀◀◀◀ or ▶▶▶▶ button.
- 4 Press the ▶/|| (CD/USB ▶/||) button. Playback will start and the file name will be displayed.
  - Title, Artist and Album name are displayed if they are recorded in the USB memory device.
  - Display content can be changed by pressing the CD/USB DISPLAY button.

**■ To remove USB memory device**

- 1 Press the ■ (CD/USB ■) button to stop playback.
- 2 Disconnect USB memory device from the USB terminal.

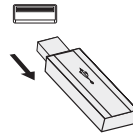

**Notes:**

- SHARP will not be held liable for the loss of data whilst the USB memory device is connected to the audio system.
- Files compressed in MP3 and/or WMA format can be played back when connected to the USB terminal.
- This USB memory's format supports FAT 16 or FAT 32.
- SHARP cannot guarantee that all USB memory devices will work on this audio system.
- USB cable is not recommended for use in this audio system to connect to USB memory device. Use of the USB cable will affect the performance of this audio system.
- This USB memory cannot be operated via USB hub.
- The USB terminal in this unit is not intended for a PC connection but is used for music streaming with a USB memory device.
- External HDD-storage cannot be played back via USB terminal.
- If the data inside the USB memory is large, it may take longer time for the data to be read.
- This product can play WMA and MP3 files. It will automatically detect the file type being played. If unplayable file is played on this product, "Not Supported" is indicated and the file will be automatically skipped. This will take a few seconds. If abnormal indications appear on the display due to the unspecified file, turn off the unit and then turn it on again.
- This product relates to USB mass storage devices and MP3 players. It may however face some irregularities due to various unforeseen reasons from some devices. Should this happen, turn off the unit and then turn it on again.
- During CD function, MP3 player will not be charging.



## Advanced USB playback

The following functions are the same as CD operations:

	Page
Direct track search .....	10
Repeat play .....	10
Random play .....	11
Programmed play (MP3/WMA) .....	11

### Note:

If USB memory device is not connected, "USB No Media" will be shown on the display.

### Notes:

- This unit only supports "MPEG-1 Audio Layer-3" format. (Sampling Frequency is 32, 44.1, 48kHz)
- Playback order for MP3 files may differ depending on the writing software used during file download.
- Bitrate which is supported by MP3 is 32~320 kbps, WMA is 64~160 kbps.
- For MP3/WMA files, please put ".MP3" ".WMA" extension. Files cannot be played back if there is no MP3/WMA extension.
- Playlists are not supported on this unit.
- This unit can display Folder Name or File Name up to 32 characters.
- Maximum total number of MP3/WMA files is 999.
- Total number of folders read is 99 including folder with non-playable file. However, the display shows only folder with MP3 files.
- The display playback time may not be displayed correctly when playing back a variable bitrate file.
- The ID3TAG information supported are TITLE, ARTIST and ALBUM only. Title name, artist name and album name can be displayed by pressing the DISPLAY button during file playback or pause mode.
- WMA meta tag also supports title, artist and album name which are recorded in WMA files. Copyright protected WMA files cannot be played back.

## Listening to the radio

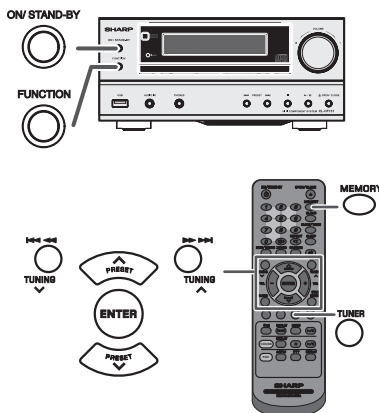

### ■ Tuning

- 1 Press the ON/STAND-BY button to turn the power on.
- 2 Press the TUNER button repeatedly to select FM Stereo or FM Mono.
- 3 Press the TUNING (∨ or ∧) button on the remote control to tune in to the desired station.
  - **Manual tuning:**  
Press the TUNING (∨ or ∧) button repeatedly to tune in to the desired station.
  - **Auto tuning:**  
When the TUNING (∨ or ∧) button is pressed for more than 0.5 seconds, scanning will start automatically and the tuner will stop at the first receivable broadcast station.

### Notes:

- When radio interference occurs, auto scan tuning may stop automatically at that point.
- Auto scan tuning will skip weak signal stations.
- To stop the auto tuning, press the TUNING (∨ or ∧) button again.
- When an RDS (Radio Data System) station is tuned in, the frequency will be displayed first, and then the RDS indicator will light up. Finally, the station name will appear.
- Full auto tuning can be achieved for RDS stations "ASPM", see page 16.

### To receive an FM stereo transmission:

- Press the TUNER button to select stereo mode and "ST" indicator will be displayed. "••••" and "•" will appear when an FM broadcast is in stereo.
- If the FM reception is weak, press the TUNER button to extinguish the "ST" indicator. The reception changes to monaural, and the sound becomes clearer.

## Listening to the radio (continued)

### Memorising a station

You can store 40 FM stations in memory and recall them at the push of a button. (Preset tuning)

- 1 Perform steps 1 - 3 in "Tuning".
- 2 Press the MEMORY button.



- 3 Within 30 seconds, press the PRESET (✓ or ▲) button to select the preset channel number. Store the stations in memory, in order, starting with preset channel 1.
- 4 Within 30 seconds, press the MEMORY button to store that station in memory. If the "MEMORY" and preset number indicators disappear before the station is memorised, repeat the operation from step 2.
- 5 Repeat steps 1 - 4 to set other stations, or to change a preset station. When a new station is stored in the memory, the station previously memorised for that preset channel number will be erased.

#### Note:

The backup function protects the memorised stations for a few hours should there be a power failure or the AC power lead become disconnected.

### To recall a memorised station

- 1 Press the PRESET (✓ or ▲) button for less than 0.5 seconds to select the desired station.

### To scan the preset stations

The stations saved in the memory can be scanned automatically. (Preset memory scan)

- 1 Press the PRESET (✓ or ▲) button for more than 0.5 seconds. The preset number will flash and the programmed stations will be tuned in sequentially, for 5 seconds each.
- 2 Press the PRESET (✓ or ▲) button again when the desired station is located.

### To erase entire preset memory

- 1 Press the TUNER button on remote control or press the FUNCTION button on main unit repeatedly to select Tuner function.
- 2 In Tuner function, press the CLEAR button until "Tuner Clear" appears.

CLEAR

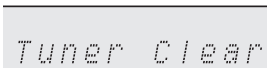

## Using the Radio Data System (RDS)

RDS is a broadcasting service which a growing number of FM stations provide. These FM stations send additional signals along with their regular programme signals. They send their station names, and information about the type of programme such as sport, music, etc.

When tuned to an RDS station, "RDS" and the station name will be displayed.

"TP" (Traffic Programme) will appear on the display when the received broadcast carries traffic information, and "TA" (Traffic Announcement) will appear whilst a traffic information is on air.

"PTY" (Dynamic PTY Indicator) will appear whilst the Dynamic PTY station is received.

RDS PTY TP TA



You can control the RDS by using the buttons on the remote control only.

### Information provided by RDS

Each time the RDS DISPLAY button is pressed, the display will switch as follows:

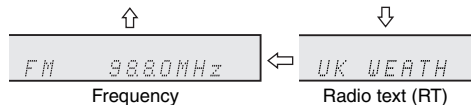
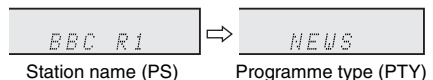
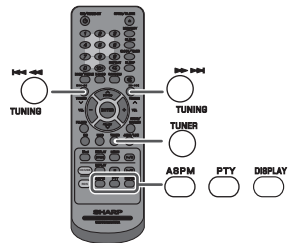

When tuning in to a station other than an RDS station or to an RDS station which sends weak signal, the display will change in the following order:

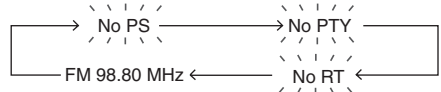

## Using the Radio Data System (RDS) (continued)

### Using the Auto Station Programme Memory (ASPM)

Whilst in the ASPM operation mode, the tuner will automatically search for new RDS stations. Up to 40 stations can be stored.

If you have already stored some stations in memory, the number of new stations you can store will be less.

- 1 Press the TUNER button on the remote control or FUNCTION button repeatedly on the main unit to select TUNER function.
- 2 Press and hold down the RDS ASPM button on the remote control.
  - 1 After "ASPM" has flashed for about 4 seconds, scanning will start (87.50 - 108.00 MHz).



- 2 When an RDS station is found, "RDS" will appear for a short time and the station will be stored in memory.



- 3 After scanning, the number of stations stored in memory will be displayed for 4 seconds, and then "END" will appear for 4 seconds.



### To stop the ASPM operation before it is complete:

Press the RDS ASPM button whilst it is scanning for stations. The stations which are already stored in memory will be kept there.

### Notes:

- If the same station is broadcasting on different frequencies, the strongest frequency will be stored in memory.
- Any station which has the same frequency as the one stored in memory will not be stored.
- If 40 stations have already been stored in memory, the scan will be aborted. If you want to redo the ASPM operation, erase the preset memory.
- If no station have been stored in memory, "END" will appear for about 4 seconds.
- If the RDS signals are very weak, station names may not be stored in memory.
- The same station name can be stored in different channels.
- In a certain area or during certain time periods, the station names may temporarily be different.

### Notes for RDS operation

If any of the following events occur, it does not mean that the unit is faulty:

- "PS", "No PS" and a station name appear alternately, and the unit does not operate properly.
- If a particular station is not broadcasting properly or a station is conducting tests, the RDS reception function may not work properly.
- When you receive an RDS station whose signal is too weak, information like the station name may not be displayed.
- "No PS", "No PTY" or "No RT" will flash for about 5 seconds, and then the frequency will be displayed.

### Notes for radio text:

- The first 14 characters of the radio text will appear for 4 seconds and then they will scroll across the display.
- If you tune in to an RDS station which is not broadcasting any radio text, "No RT" will be displayed when you switch to the radio text position.
- Whilst radio text data is received or when the text contents change, "RT" will be displayed.

### To recall stations in memory

#### To specify programmed types and select stations (PTY search):

You can search a station by specifying the programme type (news, sports, traffic programme, etc. ... see page 17) from the stations in memory.

- 1 Press the TUNER button on the remote control or FUNCTION button repeatedly on the main unit to select TUNER function.

- 2 Press the RDS PTY button on the remote control.



"SELECT" and "PTY TI" will appear alternately for about 6 seconds.

- 3 Within 6 seconds, press the <<<< or >>>> button to select the programme type.



Each time the button is pressed, the programme type will appear.

- 4 Whilst the selected programme type is flashing (within 6 seconds), press the RDS PTY button again.



After the selected programme type has been lit for 2 seconds, "SEARCH" will appear, and the search operation will start.

### Notes:

- If the display has stopped flashing, start again from step 2. If the unit finds a desired programme type, the corresponding channel number will lit for about 8 seconds, and then the station name will remain lit.
- If you want to listen to the same programme type of another station, press the RDS PTY button whilst the channel number or station name is flashing. The unit will look for the next station.
- If no station can be found, "Not Found" will appear for 4 seconds.

### If you select the traffic programme:

If you select the traffic programme (TP) in step 3, "TP" will appear.

(This does not mean that you can listen to the traffic information at that time.)

When the traffic information is broadcast, "TA" will appear.

## Using the Radio Data System (RDS) (continued)

**Descriptions of the PTY (Programme Type) codes, TP (Traffic Programme) and TA (Traffic Announcement)**  
You can search for and receive the following PTY, TP and TA signals.

<b>NEWS</b>	Short accounts of facts, events and publicly expressed views, reportage and actuality.
<b>AFFAIRS</b>	Topical programme expanding or enlarging upon the news, generally in different presentation style or concept, including debate, or analysis.
<b>INFO</b>	Programmes whose purpose is to impart advice in the widest sense.
<b>SPORT</b>	Programme concerned with any aspect of sport.
<b>EDUCATE</b>	Programme intended primarily to educate, of which the formal element is fundamental.
<b>DRAMA</b>	All radio plays and serials.
<b>CULTURE</b>	Programmes concerned with any aspect of national or regional culture, including language, theatre, etc.
<b>SCIENCE</b>	Programmes about the natural sciences and technology.
<b>VARIED</b>	Used for mainly speech-based programmes usually of light-entertainment nature, not covered by other categories. Examples include: quizzes, panel games, personality interviews.
<b>POP M</b>	Commercial music, which would generally be considered to be of current popular appeal, often featuring in current or recent record sales charts.
<b>ROCK M</b>	Contemporary modern music, usually written and performed by young musicians.
<b>EASY M</b>	Current contemporary music considered to be "easy-listening", as opposed to Pop, Rock or Classical, or one of the specialised music styles, Jazz, Folk or Country. Music in this category is often but not always, vocal, and usually of short duration.
<b>LIGHT M</b>	Classical music for general, rather than specialist appreciation. Examples of music in this category are instrumental music, and vocal or choral works.
<b>CLASSICS</b>	Performances of major orchestral works, symphonies, chamber music, etc., and including Grand Opera.
<b>OTHER M</b>	Musical styles not fitting into any of the other categories. Particularly used for specialist music of which Rhythm & Blues and Reggae are examples.
<b>WEATHER</b>	Weather reports and forecasts and meteorological information.
<b>FINANCE</b>	Stock Market reports, commerce, trading, etc.
<b>CHILDREN</b>	For programmes targeted at a young audience, primarily for entertainment and interest, rather than where the objective is to educate.
<b>SOCIAL</b>	Programmes about people and things that influence them individually or in groups. Includes: sociology, history, geography, psychology and society.

<b>RELIGION</b>	Any aspect of beliefs and faiths, involving a God or Gods, the nature of existence and ethics.
<b>PHONE IN</b>	Involving members of the public expressing their views either by phone or at a public forum.
<b>TRAVEL</b>	Features and programmes concerned with travel to near and far destinations, package tours and travel ideas and opportunities. Not for use for announcements about problems, delays, or roadworks affecting immediate travel where TP/TA should be used.
<b>LEISURE</b>	Programmes concerned with recreational activities in which the listener might participate. Examples include, Gardening, Fishing, Antique collecting, Cooking, Food & Wine, etc.
<b>JAZZ</b>	Polyphonic, syncopated music characterised by improvisation.
<b>COUNTRY</b>	Songs which originate from, or continue the musical tradition of the American Southern States. Characterised by a straightforward melody and narrative story line.
<b>NATION M</b>	Current Popular Music of the Nation or Region in that country's language, as opposed to International "Pop" which is usually US or UK inspired and in English.
<b>OLDIES</b>	Music from the so-called "golden age" of popular music.
<b>FOLK M</b>	Music which has its roots in the musical culture of a particular nation, usually played on acoustic instruments. The narrative or story may be based on historical events or people.
<b>DOCUMENT</b>	Programme concerned with factual matters, presented in an investigative style.
<b>TEST</b>	Broadcast when testing emergency broadcast equipment or receivers.
<b>ALARM</b>	Emergency announcement made under exceptional circumstances to give warning of events causing danger of a general nature.
<b>TP</b>	Broadcasts which carry traffic announcements.
<b>TA</b>	Traffic announcements are being broadcast.

## Timer and sleep operation (Remote control only)

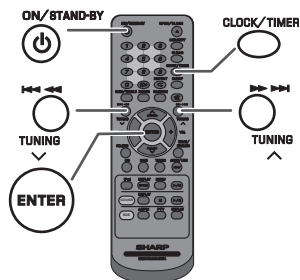

### Timer playback:

The unit turns on and plays the desired source (CD, TUNER, USB, iPod, AUDIO IN, LINE IN) at a preset time.

**This unit has 2 types of timer: ONCE TIMER and DAILY TIMER.**

#### Once timer:

Once timer play works for one time only at a preset time.

("Ⓢ" indicator).

#### Daily timer:

Daily timer play works at the same preset time every day that we set. For example, set the timer as a wake-up call every morning.

("DAILY" indicator).

#### Using the once timer and daily timer in combination:

For example, use the once timer to listen a radio programme, and use the daily timer to wake up.

- 1 Set the daily timer (pages 18 - 19).
- 2 Set the once timer (pages 18 - 19).

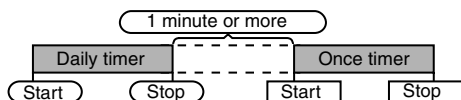

## Timer playback

### Before setting timer:

- Check that the clock is set to the correct time (refer to page 6). If it is not set, you cannot use the timer function.
- For timer playback: Plug in USB or load discs or dock iPod to be played.



- 1 Press the ON/STAND-BY button to turn the power on.
- 2 Press and hold the CLOCK/TIMER button.
- 3 Within 10 seconds, press the ◀◀◀◀ or ▶▶▶▶ button to select "Once" or "Daily", and press the ENTER button.
- 4 Within 10 seconds, press the ◀◀◀◀ or ▶▶▶▶ button to select "Timer Set", and press the ENTER button.
- 5 To select the timer playback source (CD, TUNER, USB, iPod, AUDIO IN, LINE IN), press the ◀◀◀◀ or ▶▶▶▶ button. Press the ENTER button. When you select the tuner, select a station by pressing the ◀◀◀◀ or ▶▶▶▶ button, and then press the ENTER button. If a station has not been programmed, "No Preset" will be displayed and timer setting will be cancelled.
- 6 To adjust the day, press the ◀◀◀◀ or ▶▶▶▶ button and then press the ENTER button.
- 7 Press the ENTER button to adjust the hour. Press the ◀◀◀◀ or ▶▶▶▶ button and then press the ENTER button.
- 8 To adjust the minutes, press the ◀◀◀◀ or ▶▶▶▶ button and then press the ENTER button.
- 9 Set the time to finish as in steps 7 and 8 above.
- 10 Adjust the volume using the VOLUME control, and then press the ENTER button. Do not turn the volume up too high.
- 11 Press the ON/STAND-BY button to enter the power stand-by mode. The "TIMER" indicator lights up and the unit is ready for timer playback.

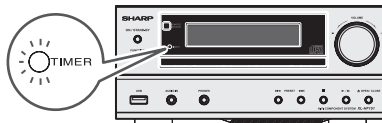

- 12 When the preset time is reached, playback will start. The volume will increase gradually until it reaches the preset volume. The timer indicator will blink during timer playback.

## Timer and sleep operation (Remote control only) (continued)

**13** When the timer end time is reached, the system will enter the power stand-by mode automatically.

### Once timer:

The timer will be cancelled.

### Daily timer:

The timer operates at the same time for every day. It will continue until the daily timer setting is cancelled. Cancel the daily timer when it is not in use.

### Notes:

- When performing timer playback using another unit connected to the USB terminal or AUDIO IN jack, select "USB" or "AUDIO IN" or "LINE IN" in step 5.
- This unit will turn on or enter the power stand-by mode automatically. However, the connected unit will not turn on or off. To stop the timer playback, follow step "Cancelling the timer setting" of this page.

### Checking the timer setting:

- 1 Turn the power on and press and hold down the CLOCK/TIMER button.
- 2 Within 10 seconds, press the ◀◀◀◀ or ▶▶▶▶ button to select "Once" or "Daily", and press the ENTER button.
- 3 Within 10 seconds, press the ◀◀◀◀ or ▶▶▶▶ button to select "Timer Call", and press the ENTER button.

### Cancelling the timer setting:

- 1 Turn the power on and press and hold down the CLOCK/TIMER button.
- 2 Within 10 seconds, press the ◀◀◀◀ or ▶▶▶▶ button to select "Once" or "Daily", and press the ENTER button.
- 3 Within 10 seconds, press the ◀◀◀◀ or ▶▶▶▶ button to select "Timer Off", and press the ENTER button. Timer will be cancelled (the setting will not be cancelled).

### Reusing the memorised timer setting:

The timer setting will be memorised once it is entered. To reuse the same setting, perform the following operations.

- 1 Turn the power on and press and hold down the CLOCK/TIMER button.
- 2 Within 10 seconds, press the ◀◀◀◀ or ▶▶▶▶ button to select "Once" or "Daily", and press the ENTER button.
- 3 Within 10 seconds, press the ◀◀◀◀ or ▶▶▶▶ button to select "Timer On", and press the ENTER button.
- 4 Press the ON/STAND-BY button to enter the power stand-by mode.

## ■ Sleep operation

The radio, compact disc, iPod, USB, Audio In and Line In can all be turned off automatically.

- 1 Play back the desired sound source.
- 2 Press the SLEEP button.
- 3 Within 5 seconds, press the Numeric button to set the time. (1 minute ~ 99 minutes)
- 4 "SLEEP" will appear.
- 5 The unit will enter the power stand-by mode automatically after the preset time has elapsed. The volume will be turned down 1 minute before the sleep operation finishes.

### To confirm the remaining sleep time:

- 1 Whilst "SLEEP" is indicated, press the SLEEP button.

### To cancel the sleep operation:

Press the ON/STAND-BY button whilst "SLEEP" is indicated. To cancel the sleep operation without setting the unit to the stand-by mode, proceed as follows.

- 1 Whilst "SLEEP" is indicated, press the SLEEP button.
- 2 Within 5 seconds, press the "0" button twice until "SLEEP 00" appears.

## ■ To use timer and sleep operation together

### Sleep and timer playback:

For example, you can fall asleep listening to the radio and wake up to CD in the next morning.

- 1 Set the sleep time (see above, steps 1 - 5).
- 2 Whilst the sleep timer is set, set the timer playback (steps 2 - 9, page 18).

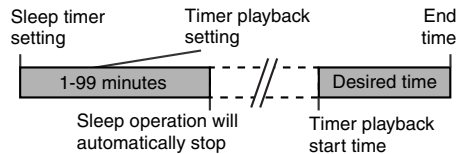

## Enhancing your system

The connection lead is not included. Purchase a commercially available lead as shown below.

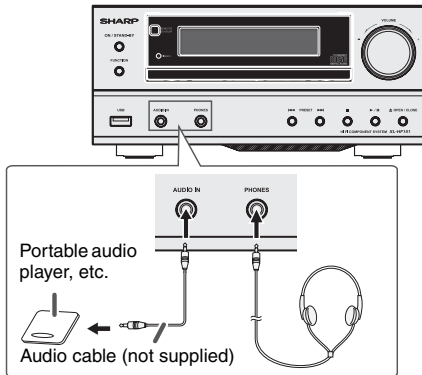

### ■ Listening to the playback sounds of portable audio player, etc.

- 1 Use a connection lead to connect the portable audio player etc. to the AUDIO IN socket. When using video equipment, connect the audio output to this unit and the video output to a television.
- 2 Press the ON/STAND-BY button to turn the power on.
- 3 Press the AUDIO/LINE (INPUT) button on the remote control or FUNCTION button repeatedly on main unit to select AUDIO IN function.
- 4 Play the connected equipment. If volume level of the connected device is too high, sound distortion may occur. Should this happen, lower the volume of the connected device. If volume level is too low, increase the volume of the connected device.

#### Note:

To prevent noise interference, place the unit away from the television.

### ■ Headphones

- Do not turn the volume on to full at switch on and listen to music at moderate levels. Excessive sound pressure from earphones and headphones can cause hearing loss.
- Before plugging in or unplugging the headphone, reduce the volume.
- Be sure your headphone has a 3.5 mm (1/8") diameter plug and impedance between 16 and 50 ohms. The recommended impedance is 32 ohms.
- Plugging in the headphone disconnects the speakers automatically. Adjust the volume using the VOLUME control.

## Troubleshooting chart

Many potential problems can be resolved by the owner without calling a service technician.

If something is wrong with this product, check the following before calling your authorised SHARP dealer or service centre.

### ■ General

Symptom	Possible cause
● The clock is not set to the correct time.	● Did a power failure occur? Reset the clock. (Refer page 6)
● When a button is pressed, the unit does not respond.	● Set the unit to the power stand-by mode and then turn it back on. ● If the unit still malfunctions, reset it. (Refer page 21)
● No sound is heard.	● Is the volume level set to "Min"? ● Are the headphones connected? ● Are the speaker wires disconnected?

### ■ CD player

Symptom	Possible cause
● Playback does not start.	● Is the disc loaded upside down?
● Playback stops in the middle or is not performed properly.	● Does the disc satisfy the standards? ● Is the disc distorted or scratched?
● Playback sounds are skipped, or stopped in the middle of a track.	● Is the unit located near excessive vibrations? ● Is the disc very dirty? ● Has condensation formed inside the unit?

### ■ Remote control

Symptom	Possible cause
● The remote control does not operate.	● Is the AC power lead of the unit plugged in? ● Is the battery polarity correct? ● Are the batteries dead? ● Is the distance or angle incorrect? ● Does the remote control sensor receive strong light?

### ■ Tuner

Symptom	Possible cause
● The radio makes unusual noises continuously.	● Is the unit placed near the TV or computer? ● Is the FM aerial placed properly? Move the aerial away from the AC power lead if it is located nearby.

## Troubleshooting chart (continued)

### ■ USB

Symptom	Possible cause
● Device cannot be detected.	<ul style="list-style-type: none"> <li>● Is there any MP3/WMA file available?</li> <li>● Is the device properly connected?</li> <li>● Is it an MTP device?</li> <li>● Does the device contain AAC file only?</li> </ul>
● Playback does not start.	<ul style="list-style-type: none"> <li>● Is it a copyright protected WMA file?</li> <li>● Is it a false MP3 file?</li> </ul>
<ul style="list-style-type: none"> <li>● Wrong time display.</li> <li>● Wrong file name display.</li> </ul>	<ul style="list-style-type: none"> <li>● Is Variable Bitrate file being played back?</li> <li>● Is the File Name written in Chinese or Japanese characters?</li> </ul>

### ■ iPod, iPhone or iPad

Symptom	Possible cause
<ul style="list-style-type: none"> <li>● No sound is produced. No image appears on the TV/monitor.</li> </ul>	<ul style="list-style-type: none"> <li>● The iPod, iPhone or iPad is not playing.</li> <li>● The iPod, iPhone or iPad is not properly connected to the unit.</li> <li>● Is the AC power lead of the unit plugged in?</li> <li>● The video cable is not properly connected.</li> <li>● The TV/monitor's input selection is not properly set.</li> <li>● The iPod TV out feature has not been set to output video.</li> <li>● USB terminal do not support video.</li> </ul>
● iPod, iPhone or iPad will not charge.	<ul style="list-style-type: none"> <li>● The iPod, iPhone or iPad is not making full contact with the connector.</li> <li>● Using iPod (3<sup>rd</sup> generation).</li> <li>● The iPod or iPhone is not supported. Refer to page 7 for compatible models.</li> </ul>
● "This accessory is not made to work with iPhone" or "This accessory is not supported by iPhone" appears on iPhone screen.	<ul style="list-style-type: none"> <li>● The iPhone battery is low. Please charge the iPhone.</li> <li>● iPhone is not properly docked.</li> </ul>

### ■ Condensation

Sudden temperature changes, storage or operation in an extremely humid environment may cause condensation inside the cabinet (CD pickup, etc.) or on the transmitter on the remote control. Condensation can cause the unit to malfunction. If this happens, leave the power on with no disc in the unit until normal playback is possible (about 1 hour). Wipe off any condensation on the transmitter with a soft cloth before operating the unit.

### ■ If problem occurs

When this product is subjected to strong external interference (mechanical shock, excessive static electricity, abnormal supply voltage due to lightning, etc.) or if it is operated incorrectly, it may malfunction.

### If such a problem occurs, do the following:

- 1 Set the unit to the stand-by mode and turn the power on again.
- 2 If the unit is not restored in the previous operation, unplug and plug in the unit again, and then turn the power on.

#### Note:

If neither operation above restores the unit, clear all the memory by resetting it.

### ■ Factory reset, clearing all memory

- 1 Press the ON/STAND-BY button to turn the power on.
- 2 Press the AUDIO/LINE (INPUT) button on the remote control or FUNCTION button repeatedly on the main unit to select LINE IN function.
- 3 In LINE IN function, press the ◀◀ button on the main unit then press and hold the ■ button until "RESET" appears.



#### Caution:

This operation will erase all data stored in memory including clock, timer settings, tuner preset, and CD programme.

### ■ Before transporting the unit

Remove the iPod, USB memory device and disc from the unit. Then, set the unit to the power stand-by mode. Carrying the unit with iPod or USB memory device left docked or discs left inside might damage the unit.

### ■ Care of compact discs

Compact discs are fairly resistant to damage, however mistracking can occur due to an accumulation of dirt on the disc surface. Follow the guidelines below for maximum enjoyment from your CD collection and player.

- Do not write on either side of the disc, particularly the non-label side from which signals are read. Do not mark this surface.
- Keep your discs away from direct sunlight, heat, and excessive moisture.
- Always hold the CDs by the edges. Fingerprints, dirt, or water on the CDs can cause noise or mistracking. If a CD is dirty or does not play properly, clean it with a soft, dry cloth, wiping straight out from the centre, along the radius.

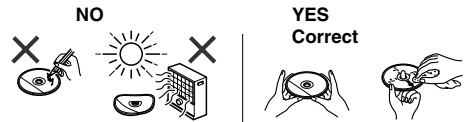

## Maintenance

### ■ Cleaning the cabinet

Periodically wipe the cabinet with a soft cloth and a diluted soap solution, then with a dry cloth.

#### Caution:

- Do not use chemicals for cleaning (petrol, paint thinner, etc.). It may damage the cabinet.
- Do not apply oil to the inside of the unit. It may cause malfunctions.



## Specifications

As part of our policy of continuous improvement, SHARP reserves the right to make design and specification changes for product improvement without prior notice. The performance specification figures indicated are nominal values of production units. There may be some deviations from these values in individual units.

### General

<b>Power source</b>	AC 220 - 240 V ~ 50/60 Hz
<b>Power consumption</b>	Power on: 45 W Power stand-by: 0.4 W (*)
<b>Dimensions</b>	Width: 215 mm (8 - 1/2") Height: 96 mm (3 - 4/5") Depth: 335 mm (13 - 1/5")
<b>Weight</b>	3.4 kg (7.5 lbs.)

(\*) This power consumption value is obtained when the demonstration mode is cancelled in the power stand-by mode. Refer to page 4 to cancel the demonstration mode.

### Amplifier

<b>Output power</b>	PMPO: 120 W MPO: 60 W (30 W + 30 W) (10% T.H.D.) RMS: 30 W (15 W + 15 W) (10% T.H.D.) RMS: 24 W (12 W + 12 W) (1% T.H.D.)
<b>Output terminals</b>	Speakers: 4 ohms 20Hz - 20kHz Subwoofer Pre-out (audio signal): 200 mV/10 k ohms at 70 Hz Video output: 1 Vp-p Headphones: 16 ohms (recommended: 32 ohms)
<b>Input terminals</b>	Audio In (audio signal): 500 mV/47 k ohms Line in (Analogue input): 500 mV/47 k ohms

### CD player

<b>Type</b>	Single disc multi-play compact disc player
<b>Signal readout</b>	Non-contact, 3-beam semiconductor laser pickup
<b>D/A converter</b>	Multi bit D/A converter
<b>Frequency response</b>	20 - 20,000 Hz
<b>Dynamic range</b>	90 dB (1 kHz)

### USB

<b>USB host interface</b>	<ul style="list-style-type: none"> <li>Complies with USB 1.1 (Full Speed)/2.0 Mass Storage Class.</li> <li>Support Bulk only and CBI protocol.</li> </ul>
<b>Support file</b>	<ul style="list-style-type: none"> <li>MPEG 1 Layer 3</li> <li>WMA (Non DRM)</li> </ul>
<b>Bitrate support</b>	<ul style="list-style-type: none"> <li>MP3 (32 ~ 320 kbps)</li> <li>WMA (64 ~ 160 kbps)</li> </ul>
<b>Other</b>	<ul style="list-style-type: none"> <li>Maximum total number of MP3/WMA files is 999.</li> <li>Maximum total number of folders is 99 INCLUSIVE of root directory.</li> <li>The ID3TAG information supported are TITLE, ARTIST and ALBUM only.</li> <li>Supports ID3TAG version 1 and version 2.</li> </ul>
<b>File system support</b>	<ul style="list-style-type: none"> <li>Support USB devices with Microsoft Windows/DOS/FAT 12/FAT 16/ FAT 32.</li> <li>2 kbyte block length for sector.</li> </ul>

### Tuner

<b>Frequency range</b>	FM: 87.5 - 108 MHz
<b>Preset</b>	40 (FM station)

### Speaker

<b>Type</b>	2-way type speaker system 5 cm (2") Tweeter 10 cm (4") woofer
<b>Maximum input power</b>	30 W
<b>Rated input power</b>	15 W
<b>Impedance</b>	4 ohms
<b>Dimensions</b>	Width: 132 mm (5-1/4") Height: 262 mm (10-5/16") Depth: 175 mm (6-7/8")
<b>Weight</b>	1.8 kg (4.0 lbs.)/each

# SHARP®

**SHARP ELECTRONICS (Europe) GmbH**

SonninstraÙe 3, D-20097 Hamburg

SHARP CORPORATION

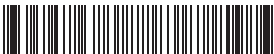

92L87501510101

11E R AS ②

UP

**XL-HF151PH(S) / XL-HF151PH(BK)**



**HI FI COMPONENT SYSTEM**



DOWN

**SHARP**

## Free Manuals Download Website

<http://myh66.com>

<http://usermanuals.us>

<http://www.somanuals.com>

<http://www.4manuals.cc>

<http://www.manual-lib.com>

<http://www.404manual.com>

<http://www.luxmanual.com>

<http://aubethermostatmanual.com>

Golf course search by state

<http://golfingnear.com>

Email search by domain

<http://emailbydomain.com>

Auto manuals search

<http://auto.somanuals.com>

TV manuals search

<http://tv.somanuals.com>