



SHARP

PORTABLE MINIDISC RECORDER

MODEL

MD-MT90



OPERATION MANUAL



Thank you for purchasing this SHARP product.
For the best performance, read this manual carefully.
It will guide you in operating your SHARP product.

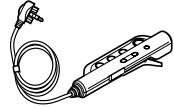

Accessories

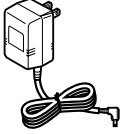
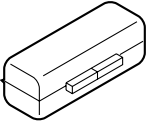
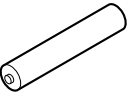
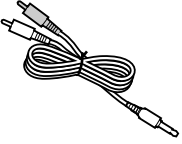
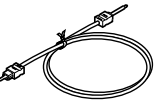
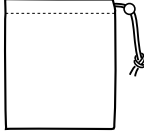
 <p>Remote Control x 1 (RRMCW0002AWSA)</p>	 <p>Headphones x 1 (RPHOH0005AWZZ)</p>	 <p>AC Adaptor (RADPA3048AWZZ) x 1</p>	 <p>Battery Carrying Case x 1 (UBAGC0003AWZZ)</p>
 <p>Rechargeable Nickel-Metal Hydride Battery (AD-N70BT) x 1 (UBATM0003AWSA)</p>	 <p>Connection Cable (for analog recording) x 1 (QCNWG0029AWZZ)</p>	 <p>Connection Cable (for digital recording) x 1 (QCNWG0422AFZZ)</p>	 <p>Carrying Bag x 1 (UBAGC0006AWSA)</p>

Notes:

- Parts and equipment mentioned in this operation manual other than those detailed above are not included.
- The AC adaptor may be different from the one in the drawing.

Optional accessories

- Rechargeable Nickel-Metal Hydride Battery (AD-N70BT)
- Car adaptor (AD-CA20X)
- Cassette adaptor (AD-CT14)

For optional accessories, contact your local dealer, call the **Sharp Accessories and Supply Center** at **1-800-642-2122**, or visit SHARP's web site (<http://www.sharp-usa.com>).

Contents

■ Important Introduction	
Special Notes	4-5
Names of Controls and Indicators	6-7
Precautions	8
■ Preparation	
Inserting a MiniDisc	9
Connections	10-11
■ Basic Operation	
Recording	12-13
Playback	14-15
■ Useful Features	
Advanced Playback	16-17
Advanced Recording	18-22
Recording from a Microphone	23-25
Checking Displays	26-27
Battery Power	28-29
Hold Function	30
■ Advanced Features	
Changing Default Settings	31
Titling a MiniDisc	32-35
Editing a Recorded MiniDisc	36-38
Listening through Another System	39
■ References	
Other Features and Caution	40
MiniDisc System Limitations	41
Error Messages	42-43
Troubleshooting	44-45
Maintenance	45
Specifications	46-47
CONSUMER LIMITED WARRANTY Back cover	

Important Introduction
-Contents-

Special Notes

- It is the intent of Sharp that this product be used in full compliance with the copyright laws of the United States and that prior permission be obtained from copyright owners whenever necessary.

Caution - use of controls or adjustments or performance of procedures other than those specified herein may result in hazardous radiation exposure.

- "BATTERY DISPOSAL"
CONTAINS NICKEL-METAL HYDRIDE BATTERY. MUST BE DISPOSED OF PROPERLY. CONTACT LOCAL AGENCIES FOR INFORMATION ON RECYCLING AND DISPOSAL PLANS IN YOUR AREA.
- US and foreign patents licensed from Dolby Laboratories.
- The letters in brackets contained in the model number indicate the color of the product only. Operation and specifications are unaffected.

FOR YOUR RECORDS

For your assistance in reporting this unit in case of loss or theft, please record below the model number and serial number which are located on the bottom of the unit.

Please retain this information.

Model number _____

Serial number _____

Date of purchase _____

Place of purchase _____

Note:

This equipment has been tested and found to comply with the limits for a Class B digital device, pursuant to Part 15 of the FCC Rules.

These limits are designed to provide reasonable protection against harmful interference in a residential installation.

This equipment generates, uses, and can radiate radio frequency energy and, if not installed and used in accordance with the instructions, may cause harmful interference to radio communications.

However, there is no guarantee that interference will not occur in a particular installation.

If this equipment does cause harmful interference to radio or television reception, which can be determined by turning the equipment off and on, the user is encouraged to try to correct the interference by one or more of the following measures:

- Reorient or relocate the receiving antenna.
- Increase the separation between the equipment and receiver.
- Connect the equipment into an outlet on a circuit different from that to which the receiver is connected.
- Consult the dealer or an experienced radio/TV technician for help.

WARNING:

FCC Regulations state that any unauthorized changes or modifications to this equipment not expressly approved by the manufacturer could void the user's authority to operate this equipment.

Names of Controls and Indicators

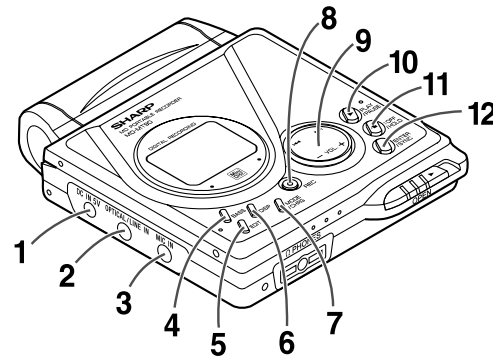

■ Main unit

1. 5V DC Input Jack (10)
2. Optical/Line Input Jack (10, 11)
3. Microphone Input Jack (23)
4. Bass/Delete Button (15, 33)
5. Edit/Auto Mark/Time Mark Button (21, 25, 32)
6. Display/Character Select Button (26, 32)
7. Mode/Charge Button (17, 28)
8. Record/Track Mark Button (12, 21)
9. Volume/Cursor/Fast Forward/Fast Reverse/Recording Level/Name Select Button (12, 15, 16, 32, 33)
10. Play/Pause Button (12, 15)
11. Stop/Power Off/Hold Button (13, 15, 30)
12. Enter/Fast Play/Synchro Button (17, 18, 20)
13. Remote Control/Headphones/Line Output Jack (14, 39)
14. Open Lever (9)
15. Battery Cover (28)

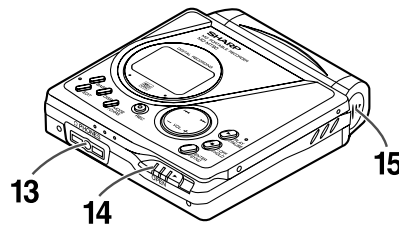

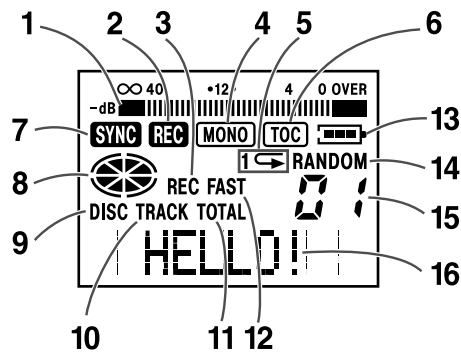

■ Display panel

1. Level Meter (12)
2. Record Indicator (12)
3. Remaining Recording Time Indicator (26)
4. Monaural Long-Play Mode Indicator (19)
5. Repeat Indicator (17)
6. TOC Indicator (13)
7. Synchro Recording Indicator (18)
8. Disc Mode Indicator
9. Disc Name Indicator (26)
10. Track Name Indicator (26)
11. Total Track Number Indicator (26)
12. Fast Play Indicator (17)
13. Battery Indicator (27)
14. Random Indicator (17)
15. Track Number Indicator (26)
16. Character/Time Information Indicator

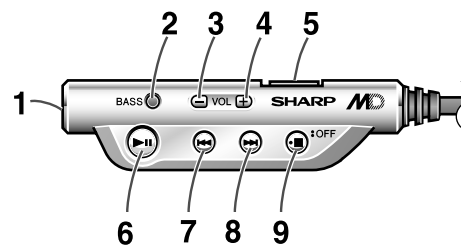

■ Remote control unit

1. Headphones Jack (14)
2. Bass/Delete/Track Mark Button (15, 21, 33)
3. Volume Down/Cursor Button (15, 33)
4. Volume Up/Cursor Button (15, 33)
5. Hold Switch (30)
6. Play/Pause Button (12, 15)
7. Fast Reverse/Recording Level Down/Name Select Button (12, 16, 32)
8. Fast Forward/Recording Level Up/Name Select Button (12, 16, 32)
9. Stop/Power Off Button (13, 15)

Precautions

■ Important

- Do not wear your headphones when you are crossing streets or near traffic.
- Do not use your headphones while driving a motor vehicle, it may create a traffic hazard and may be illegal. Remember to obey all of the safety rules in your area.



- Do not play the unit at a high volume. Hearing experts advise against extended listening at high volume levels.
- If you experience ringing in your ears, reduce the volume or discontinue use.
- This portable MD should only be used within the range of 32°F - 104°F (0°C - 40°C).

To avoid accidental electric shock or other possible problems, observe the precautions listed below.

- Do not disassemble or modify the unit.
- Do not drop or subject the unit to shock.
- Do not use the unit near open flames.
- Do not spill liquid on the unit.
- Do not use an external power supply, other than the 5V DC supplied with this unit, as it may damage it.
- SHARP is not responsible for damage due to improper use. Refer all servicing to a SHARP authorized service center.

■ Storing the unit

Avoid using or leaving the unit in the following places.

- Places exposed to direct sunlight for many hours (especially in cars with the doors and windows closed) or near heaters. (The cabinet may deform, change color or the unit may malfunction.)
- Places exposed to excessive dust.
- Places exposed to water.



- Places where temperatures are excessively high or low.

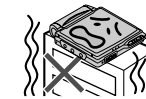

- Places (bathrooms) where the humidity is extremely high.
- Places with strong magnetic fields such as TVs or loudspeakers.
- Places exposed to vibration.
- Places where sand can easily enter the inside of the unit (beaches etc.).

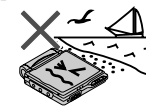

- If the unit is used near radio tuners or TVs, noise and/or picture interference may result. If you experience these problems, move the unit away from such devices.
- It is not recommendable to put the MiniDisc into a rear pocket, as this may damage the product when sitting.

Inserting a MiniDisc

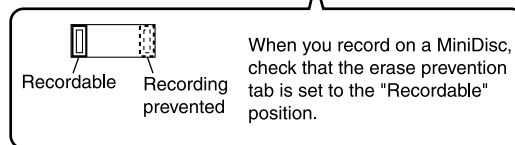
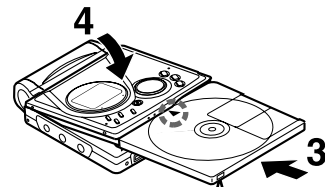
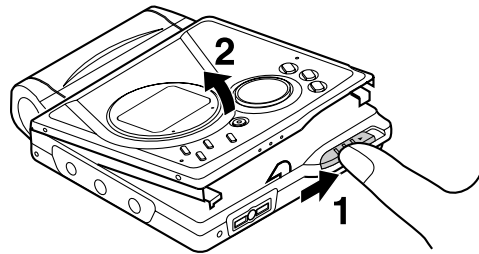

- | |
|---|
| 1 Slide the OPEN lever to release the compartment door. |
| 2 Lift it up. |
| 3 Insert a MiniDisc as shown. |
| 4 Close the compartment door. |

Notes:

- Do not place the MiniDisc under the holder.

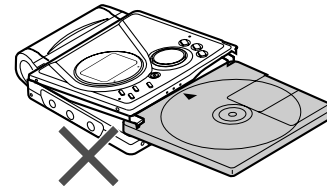

- If any resistance is felt, do not force the MiniDisc into the unit, as it may cause damage to the unit. If resistance is felt, remove the MiniDisc and reload it.
- The lid cannot be opened if "TOC" is displayed. Refer to the instruction on page 13.

Connections

You can record your favorite CDs or tapes to MD.

■ To connect to a stereo system with "LINE OUT" or "AUDIO OUT" jacks

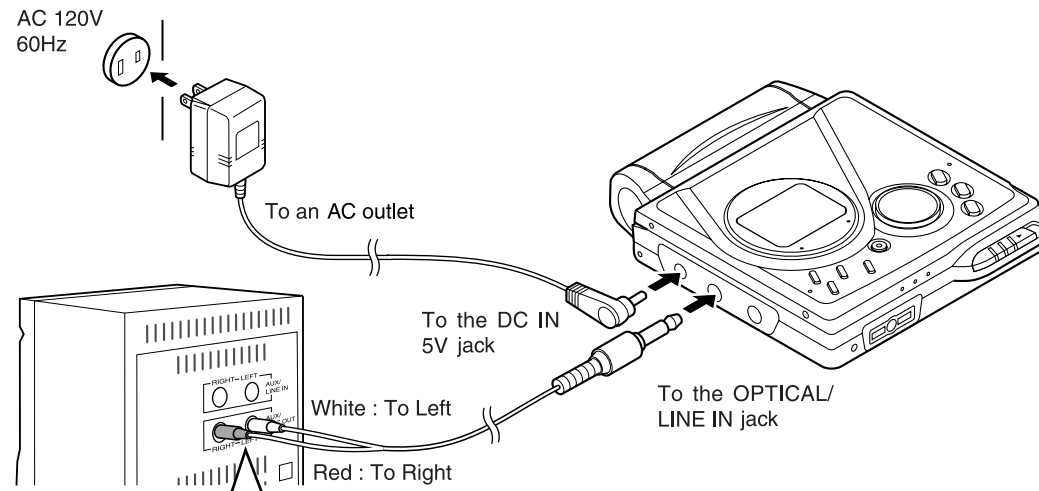

LINE OUT	To a stereo system with "LINE OUT" or "AUDIO OUT" jacks
RIGHT LEFT	Note: If the audio system has only one pair of jacks, they are usually for input only and recording via this connection is not possible.

■ To connect to a stereo system with a "DIGITAL OUT" or "OPTICAL OUT" jack

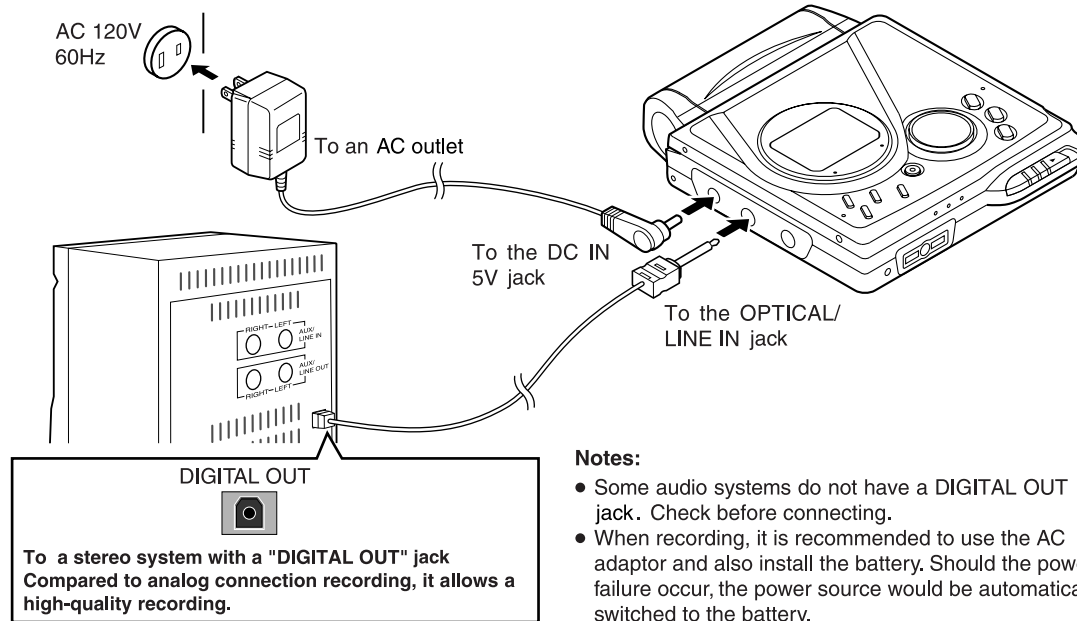

Recording

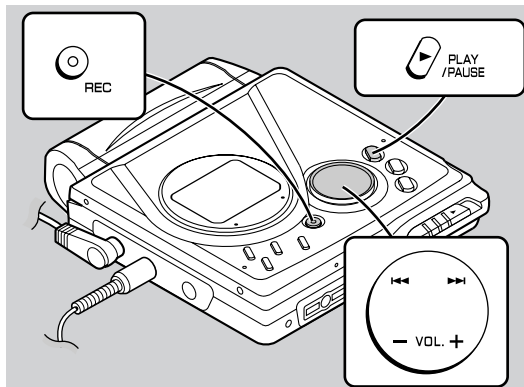

Before Recording



: OFF
/ HOLD

Cancel the hold mode.
The portable MD does not work
while in the hold mode.
As for the details, see page 30.

- 1** Press the REC button.
- 2** Begin playback on the stereo system connected to this portable MD.

- 3** Press the ◀◀ or ▶▶ button to adjust the recording level.

<Analog recording>

Adjust the recording level so that the maximum sound volume from the source makes the reading swing somewhere between - 4 dB and 0 dB.

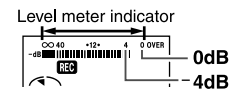

<Digital recording>

You can adjust the level in 1dB increments within the range of +12 - -12dB.



Once you adjust the digital recording level, the setting remains even after the recording stops. (For cancellation instructions, see page 31.)

- 4** Press the PAUSE button on the stereo system to enter the playback pause mode.

Here you can search for the track to record.

5 Press the PLAY/PAUSE button to start the MiniDisc unit recording.

6 Begin playback on the stereo system, and the output will be recorded.

To interrupt recording

Press the PLAY/PAUSE button.

- To resume recording, press the PLAY/PAUSE button again.
- The track number will be increased by one each time the recording is interrupted.

To stop recording

Press the ■:OFF button.

- When recording stops, "TOC" appears. While "TOC" appears, the MiniDisc recorded contents have not yet been updated.
- To prevent the new recording from being lost, it is not possible to remove the MiniDisc while "TOC" is displayed.

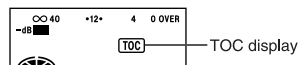

To update the recorded contents of the MiniDisc

Press the ■:OFF button while in the stop mode.

The power turns off after recorded contents have been updated on the MiniDisc.

About the TOC

After any recording or editing function, "TOC" (Table Of Contents) is displayed. To finalise the recording or editing function, press the ■:OFF button. During this process, "TOC" will flash and "TOC EDIT!" will be displayed. During any recording or editing function, the MiniDisc unit lid is locked, and the MiniDisc cannot be removed until the process is finalised.

Warning:

If the power is removed (Battery/AC adaptor) while "TOC" is displayed, the MiniDisc unit lid will remain locked until the battery/main power is restored and the unit is turned on. Your new recordings or edited changes will be lost and your MiniDisc may become unusable.

Caution:

While "TOC" or "TOC EDIT!" is displayed, follow the instructions below.

- Do not jerk or bump the unit.
- Do not unplug the AC adaptor.
- Do not remove the rechargeable battery or an alkaline battery.
- Do not subject the unit to shock.

Otherwise, tracks may not be recorded properly.

Notes:

- Changing the volume level while recording does not affect the recording.
- You cannot adjust the bass level while recording.

Playback

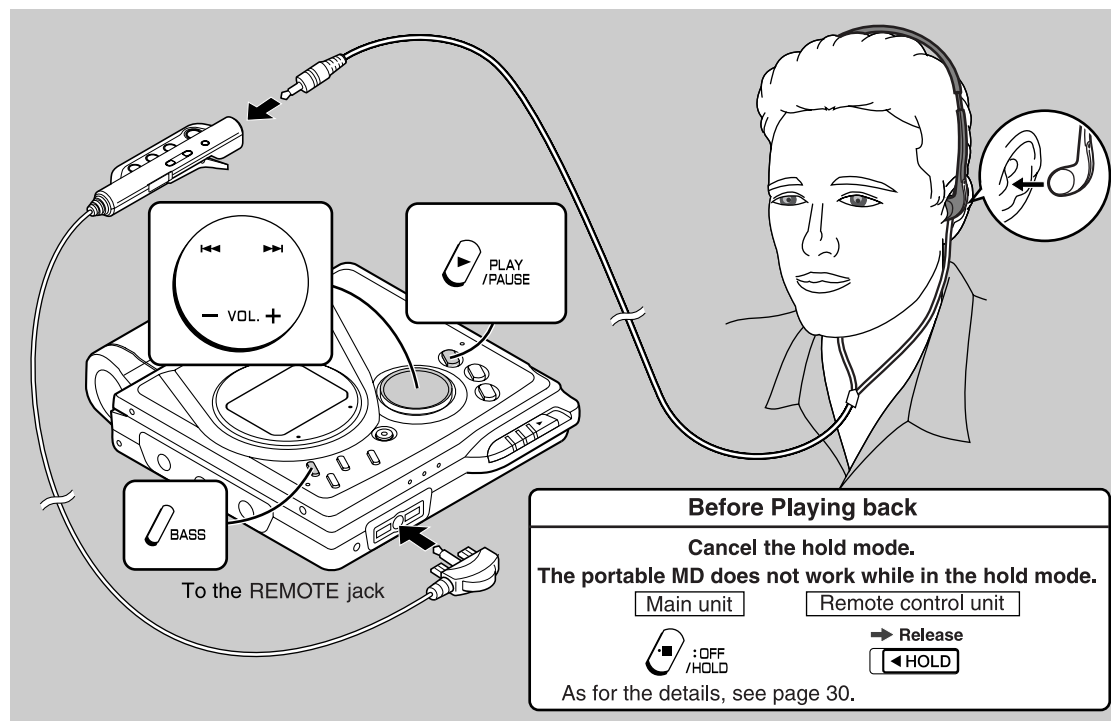

1 Insert the headphones plug firmly into the headphones jack on the remote control unit.

2 Plug the remote control into the REMOTE jack on the unit.

3 Insert a MiniDisc (page 9).

4 Press the PLAY/PAUSE button.

Playback starts automatically with a playback only MiniDisc or a MiniDisc which is protected against accidental erasure (Auto-play function).

To interrupt playback

Press the PLAY/PAUSE button.

To resume playback, press the PLAY/PAUSE button again.

To stop playback

Press the ■:OFF button.

If the unit is not operated for at least 2 minutes while in the stop mode, the power will shut off automatically.

To turn off the power

Press the ■:OFF button while in the stop mode.

■ Volume control

Press the VOL+ button to increase the volume and the VOL- button to decrease the volume.

Volume (0 - 30) — Vol 15 ■

■ Bass control

Each time the BASS button is pressed, the tone will be switched as follows.

BASS 1	Emphasized slightly
BASS 2	Emphasized more
BASS 3	Emphasized fully
BASS OFF	Canceled

Notes:

- If power failure occurs while playing a disc using the AC adaptor, disconnect it from the AC outlet. Otherwise, playback may start automatically when electricity resumes.
- If you connect the AC adaptor without installing the rechargeable battery, playback may start automatically. Be sure to turn off the power.
- Reduce the volume before starting to play. MiniDiscs, compared to ordinary cassette tapes, have very little noise. If the volume is adjusted according to your usual expectations of noise, high volume may damage your hearing.
- The sound escaping from your headphones may annoy people around you. In particularly crowded places (such as on trains or buses), reduce the volume.

Advanced Playback

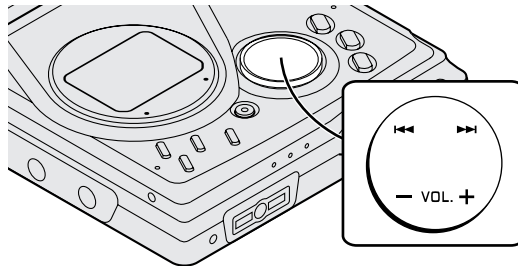

■ To locate the desired portion

For audible fast forward:

Press and hold down the ►► button during playback.

For audible fast reverse:

Press and hold down the ◀◀ button during playback.

- Normal playback will resume when the ◀◀ or ►► button is released.
- When the end of the last track is reached during fast forward, the unit will enter the pause mode. When the beginning of the first track is reached during fast reverse, the unit will enter the playback mode.

■ To locate the beginning of a track

To move to the beginning of the next track:

Press the ►► button during playback.

To restart the track being played:

Press the ◀◀ button during playback.

To locate the next track:

Press the ►► button while the unit is stopped.

To locate the previous track:

Press the ◀◀ button while the unit is stopped.

- To skip a number of tracks at one time, press the ◀◀ or ►► button repeatedly until the desired track number is shown.
- When you press the PLAY/PAUSE button, playback starts from the beginning of the track.

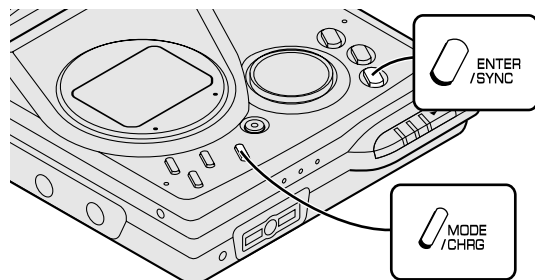

■ To play at double speed

Press the ENTER/SYNC button while a MiniDisc recorded in the monaural long-play mode is being played.

FAST PLAY

- If a track recorded in the stereo mode is reached during fast playback, the fast playback mode will be canceled.
- Depending on the contents recorded on a MiniDisc, it may be difficult to hear them.

To interrupt fast playback

Press the PLAY/PAUSE button during playback. When the PLAY/PAUSE button is pressed again, the unit will resume fast playback.

To return to normal playback

Press the ENTER/SYNC button.

■ Random play or repeat play

During playback, press the MODE/CHRG button repeatedly to select the playback mode.

RANDOM	Random play
◁RANDOM	Repeat play of tracks in random order
◁	Repeat play of all of the tracks
1◁	Repeat play of a single track
No display	Normal playback

Notes:

- If the playback mode is selected while stopped, press the PLAY/PAUSE button to start playback.
- When "TOC" is displayed, random play or repeat play is impossible.
- In random play the unit will select and play tracks automatically. (You cannot select the order of the tracks.) After all of the tracks have been played once each in random order, the unit will stop automatically.
- During random, random repeat, or single track repeat play, you can forward or reverse the MiniDisc only within the track being played.
- During random play, the unit cannot find the beginning of any track which has been played.
- Repeat play lasts until you stop the unit.

Advanced Recording

■ Playback sound-actuated recording

Recording automatically starts or pauses by detecting sound from the stereo system (Synchronized recording).

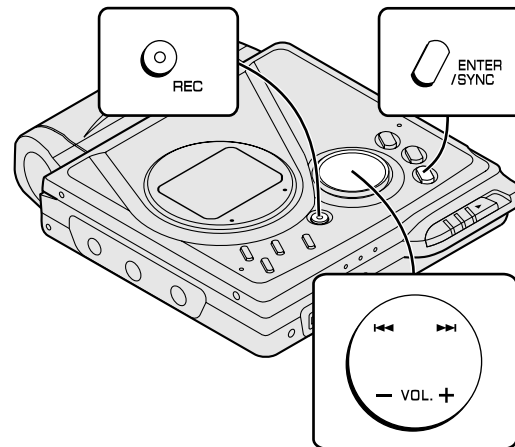

- 1 Press the REC button.**
- 2 Begin playback on the stereo system connected to this portable MD.**

- 3 Press the ◀◀ or ▶▶ button to adjust the recording level. (See page 12.)**
- 4 Press the PAUSE button on the stereo system to enter the playback pause mode.**

Select the starting point for your recording and press the PAUSE button.
- 5 Press the ENTER/SYNC button.**
 - "SYNC" will be displayed.
 - To cancel the operation, press the ■/OFF button.
- 6 Begin playback on the stereo system. Recording will begin automatically.**

To interrupt recording

- When the stereo system is stopped, the unit will enter the synchro recording pause mode. When playback is resumed, the recording will be resumed.
- If a silence lasts for 3 seconds or more, the recording will be paused (the pause function does not work for approximately 10 seconds after a recording starts). When the unit receives sound again, recording automatically starts.
- A new track number is created when the recording resumes.

■ Long-play recording

When recording in the monaural long-play mode, the available recording time will be doubled. Monaural long-play recordings can be replayed at double speed, see page 17.

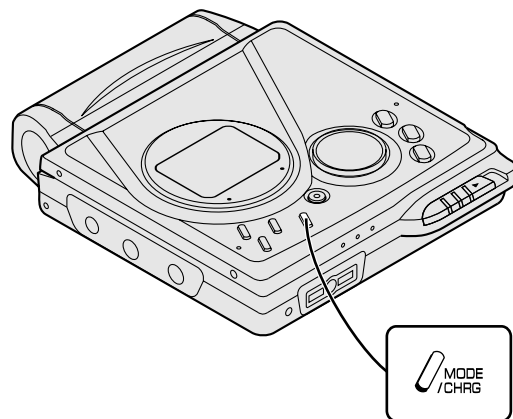

1 Press the MODE/CHRG button while the recording is paused.

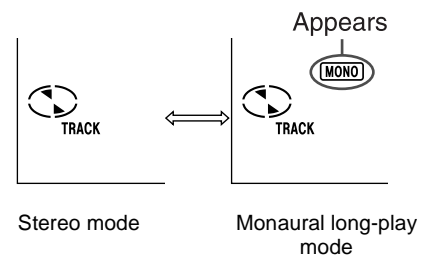

2 Start recording.

Notes:

- When the unit is stopped after a recording has been made in this mode, the recording mode will return to the stereo mode automatically.
- If input is from a stereo source, the sounds from the left and right channels will be combined.
- Although the monitor sound you hear in the headphones while recording is in stereo, recording will be monaural.
- MiniDiscs recorded in the monaural long-play mode may not play on other MiniDisc players.

Advanced Recording (continued)

■ To start recording from the middle of a track

You can erase a portion of a track and make a new recording. All of the tracks that follow the newly recorded track will be erased.

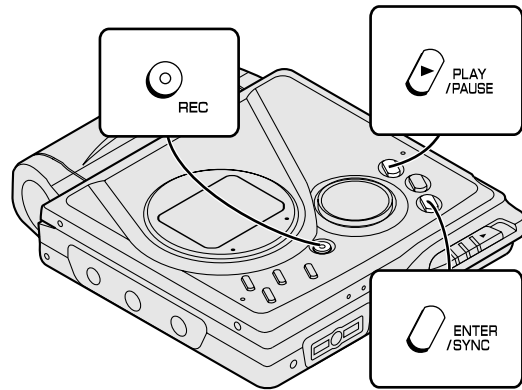

1 During playback, press the **PLAY/PAUSE** button at the point where you want to begin recording.

2 Press the **REC** button.

ERASE OK?

To cancel the operation, press the **■/OFF** button.

3 Press the **ENTER/SYNC** button.

All of the tracks and track names will be erased, following the point where the playback is paused.

4 Press the **PLAY/PAUSE** button.

Recording will start.

Note:

To keep a track after the point you want to make a new recording, move the track and then make recording after that point. (See "Editing a Recorded MiniDisc", page 38.)

■ To create your own track numbers

You can create your own track numbers at any point.

While recording, press the REC button at the point where you want to create track numbers.

The track number will be increased by one.

- One track number will be added every time the REC button is pressed.
- The BASS button on the remote control can also be used to add track numbers.

■ Recording tracks as a single track

You can record several pieces of music as a single track by disabling the auto marker function.

When a recording is paused or while recording...

Press the EDIT button.



Note:

When making digital recordings using a CD player or an MiniDisc player, track numbers will be created automatically regardless of the setting of the auto marker function.

■ To prevent recorded MiniDiscs from being erased accidentally

Slide the accidental erase prevention tab, located on the side of the MiniDisc, in the direction indicated by the arrow.

The MiniDisc will then be protected against accidental erasure.

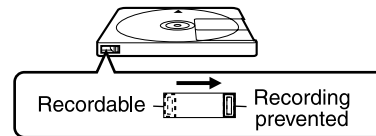

To add a recording to such a MiniDisc, slide the accidental erase prevention tab back to its original position.

■ Helpful tip when attaching a label

When attaching a label to a MiniDisc cartridge, be sure to note the following. If the label is not attached properly, the MiniDisc may jam inside the unit and it may not be possible to remove it.

- If the label peels off or partially lifts away, replace it with a new one.
- Do not put a new label on top of an existing one.
- Attach the label only in the specified location.

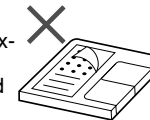

Advanced Recording (continued)

■ About track numbers

- Track numbers are created automatically during recording via the analog connection when a silence of 1 second or more is detected (Auto marker function). A series of tracks can be recorded as one by disabling the auto marker function, see page 21.

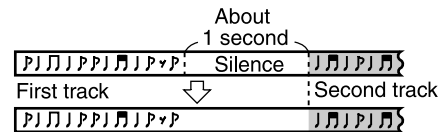

- When recording from a CD or a MiniDisc using the digital connection, track numbers will be created at the same points as on the CD or MiniDisc (Synchro marker function).

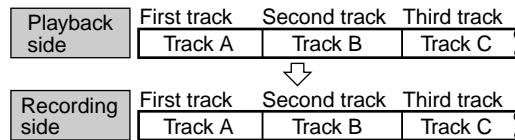

- Track numbers may not be created in proper places, depending on the source to be recorded from, such as signals with noise.
- The track numbers on the playback side may not match the track numbers recorded on the MiniDisc.

- When recording, if a programmed playback is performed by the source or playback is performed by selecting tracks manually, the MiniDisc track numbers may not be the same as on the source.
- Track numbers may not be created properly, depending on the connected stereo system.

■ About sampling rate converter

This portable MD incorporates a sampling rate converter, which means it can record from digital radios or DAT tape recorders.

■ Note for digital recording

You cannot copy a MiniDisc that you recorded from digital inputs to another MiniDisc or DAT. It is prevented by the SCMS (Serial Copy Management System). Recording from analog inputs is not affected.

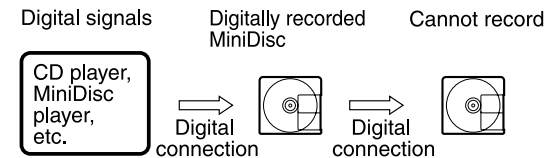

Recording from a Microphone

■ To record from a microphone

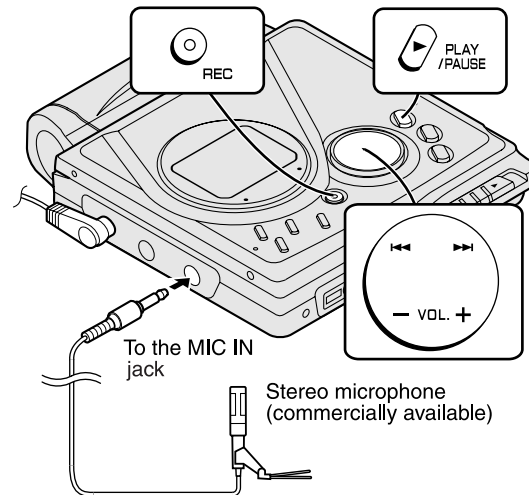

1 Connect a stereo microphone to the MIC IN jack.

2 Insert a recordable MiniDisc (page 9).

3 Press the REC button.

4 Press the ◀◀ or ▶▶ button to adjust the recording level.

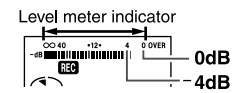

Adjust the recording level so that the maximum sound volume from the source makes the reading swing between -4 dB and 0 dB.

5 Press the PLAY/PAUSE button.

Recording will start.

To interrupt a recording

Press the PLAY/PAUSE button while recording. To resume recording, press the PLAY/PAUSE button again. The track number will be increased by one each time you interrupt a recording.

To stop recording

Press the ■/OFF button.

To write recorded contents on the MiniDisc

Press the ■/OFF button while in the stop mode.

Recording from a Microphone (continued)

■ Sound-actuated recording (Mic Synchronized recording)

1 Press the REC button.

2 Press the ◀◀ or ▶▶ button to adjust the recording level.

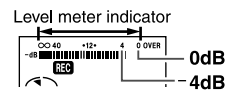

3 Press the ENTER/SYNC button to select the recording sensitivity.

MIC SYNC H : Recording starts when the unit detects -24 dB or more (The unit can start recording from quiet sounds).

MIC SYNC L : Recording starts when the unit detects -12 dB or more.

4 When a sound, such as person speaking, is picked up by the microphone, recording will begin automatically.

About the pause function

The unit automatically pauses when the microphone does not pick up any sound for 3 seconds or more. (The pause function does not work for approximately 10 seconds after a recording starts.) When the microphone picks up sound again, recording starts automatically.

Notes:

- While making a mic recording, do not connect anything to the OPTICAL/LINE IN jack on the portable MD.
- To use a microphone, be sure it is a plug-in-power type microphone.
 - When a plug-in-power type microphone is plugged in, the portable MD will provide power for the microphone's operation.
 - If a different type of microphone is plugged in, it may not operate properly or it may cause the unit to malfunction.
- Insert the plug firmly. If you don't, the recording will not be made properly.
- Use a microphone with a 1/8" (3.5 mm) diameter stereo mini plug.
- If the unit starts recording too often from low unwanted noises, set the microphone input to "MIC SYNC L".
- Recording sensitivity can be changed while recording.

■ **Track intervals**

When recording from the microphone, track numbers will be created automatically at regular intervals (default setting: approximately every 5 minutes). During a mic synchro recording, the unit pauses when a silence lasts for 3 seconds or more, and creates a track number.

Changing intervals between tracks

1 When a recording is paused or while recording, press the EDIT button repeatedly.

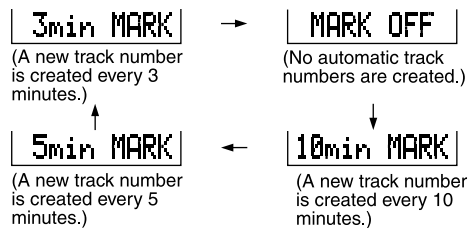

The interval between marks may vary slightly compared with the actual recording time.

2 Track numbers will be created automatically at regular intervals.

Example: Set to "5 minutes".

During a mic manual recording

Timed auto marks will be created every 5 minutes.

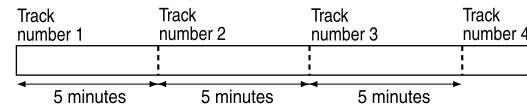

During a mic synchro recording

If a silence lasts for 3 seconds or more, a timed auto mark will be created 5 minutes after the previous mark is created.

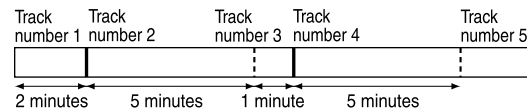
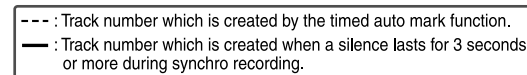

Creating track numbers manually

Press the REC button while recording.

Checking Displays

- To check the elapsed time and remaining time of the track

During playback, press the DISP button.

Each time the button is pressed, the display will change as follows.

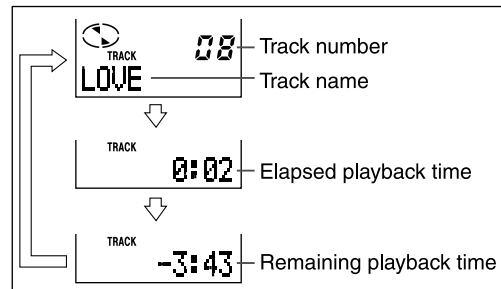

Notes:

- If the disc name or the track name was not originally recorded on the MiniDisc, "NO NAME" will be displayed.
- Remaining recording time will not be displayed with a playback-only MiniDisc.
- Elapsed playback time and remaining playback time may be different from the actual time.

- To check the remaining recording time and the total playing time

While in the stop mode, press the DISP button.

Each time the button is pressed, the display will change as follows.

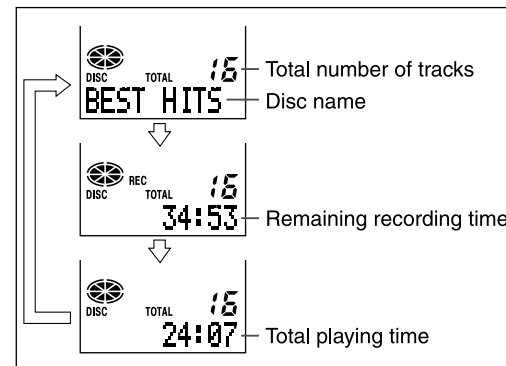

■ To display the playing time of an individual track

1 While in the stop mode, press the **◀◀** or **▶▶** button to display the track number and track name.

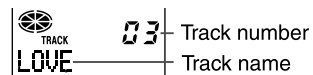

2 Press the **DISP** button to display the playing time for that track.



Each time the **◀◀** or **▶▶** button is pressed, the playing time of the previous or next track will be displayed.

■ Checking the remaining amount of battery level

The remaining amount of battery level is shown by the battery indicator () during operation.

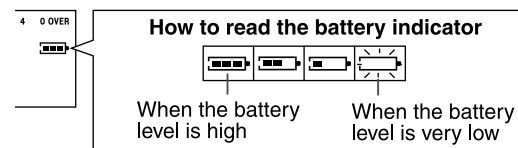

- When the battery is completely discharged, the battery indicator will flash. Recharge the battery or replace the alkaline battery with a new one.
- When the battery has run completely out, "BATT EMPTY" will appear. Then, the power will be disconnected automatically.

Notes:

- If you use the battery which you stopped charging halfway, "" may appear. It does not mean that the battery is completely charged.
- The battery indicator will not correctly display the remaining capacity for approximately 10 seconds after the power has been turned on.
- When the AC adaptor or a separately available car adaptor is used, the battery indicator will not be shown.
- The number of bars shown in the battery indicator may increase or decrease, depending on the operation being performed. This is normal.

Battery Power

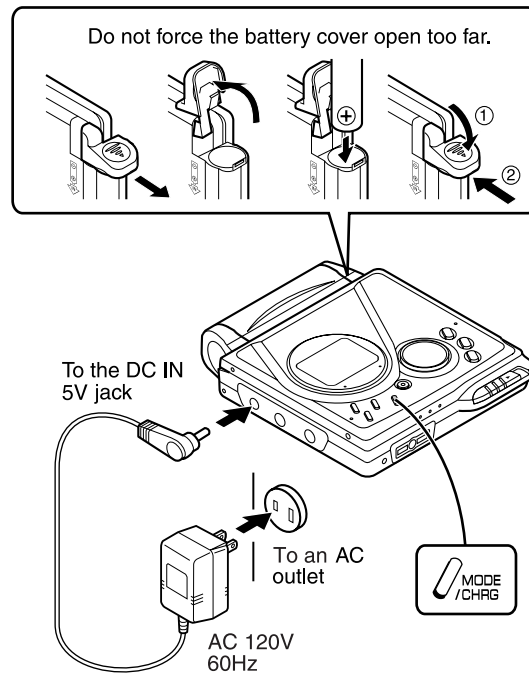

■ Charging the rechargeable battery

When the rechargeable battery is used for the first time or when you want to use it after a long period of disuse, be sure to charge it fully.

1 Insert the rechargeable battery.

A rechargeable battery other than the one supplied or the optional one (AD-N70BT) cannot be charged.

2 Plug the AC adaptor into the AC outlet, and then insert the plug on the other end into the DC IN 5V jack.

3 Press the MODE/CHRG button.

"" will flash, and battery will begin charging.

- After the rechargeable battery is charged or used, it will get slightly warm. This is normal.
- When the portable MD is turned on or operating, the battery will not be charged.

■ About charging time

After about 3.5 hours have passed, "🔋" will go out. The battery charging is about 90% complete.

To charge the battery fully, continue charging for about 2 more hours. In this case, you do not need to press the MODE/CHRG button. Even if the MODE/CHRG button is pressed, "🔋" will not appear.

Notes:

- Charge the battery within the range of 41°F - 95°F (5°C - 35°C).
- Charging is completed when "🔋" does not blink when you plug in the AC adaptor and press the MODE/CHRG button.
- The unit can be left in the charging state after it is completed.

Caution:

- Use the specified battery AD-N70BT only. Do not charge a battery (nickel-cadmium, alkaline, etc.) other than that specified.
- Do not remove the outer cover of the rechargeable battery. It may cause heat generation, fire, or explosion.
- Do not dip the battery in water, do not dispose of it in a fire, and do not take it apart.
- If the rechargeable battery terminal is dirty, charging may not start. In such a case, wipe off the dirt with a dry cloth.
- Do not disassemble the battery.



■ Using with the rechargeable or alkaline battery

1 Disconnect the AC adaptor.

2 Insert the rechargeable battery or alkaline battery from the (+) marked side.

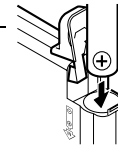

Use a commercially available LR6, "AA" size alkaline battery.

Notes:

- Setting the volume level to "0" while recording with the rechargeable or an alkaline battery reduces the battery drain.
- When you do not use the unit for hours, remove the battery. (The battery drains gradually even when the power is turned off.)
- Carry the battery in the supplied case.
- This unit can be used with the AC adaptor when the rechargeable or an alkaline battery is in the unit.

Caution:

Do not use a nickel-cadmium battery.

Hold Function

The present operation condition can be kept even if other buttons are accidentally pressed in a place such as a crowded train.

Main unit

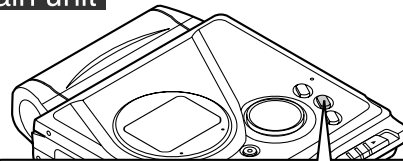

Press the HOLD button for 2 seconds or more.

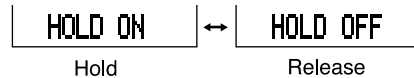

If the battery is inserted or the AC adaptor is connected, you can set this function even when the power is turned off.

To cancel the hold mode

Press and hold down the HOLD button for 2 seconds or more while the unit is in the hold mode. "HOLD OFF" will be shown.

Remote control unit

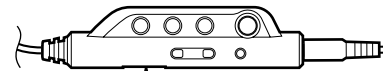

Move the HOLD switch to the safety position (direction indicated by the arrow).

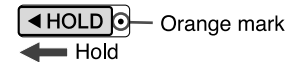

To cancel the hold mode

Move the HOLD switch away from the safety position (the opposite direction of the arrow).

If the hold function is active while the power is turned off, the power cannot be turned on by mistake and the battery will not be drained.

Changing Default Settings

While in the stop mode ...

1 With a MiniDisc inserted, press the MODE/CHRG button for 2 seconds or more. "SET UP" will appear.

When you release the button, "BEEP ON" or "BEEP OFF" will appear.

2 Press the ◀◀ or ▶▶ button to display the menu.

3 Press the MODE/CHRG button to switch items.

4 Press the ■:OFF button.

MENU	SETTING ITEM	
BEEP ON (Confirmation sound)	BEEP ON*	Beep
	BEEP OFF	Silent
A-PLAY ON (Auto play)	A-PLAY ON*	Setting
	A-PLAY OFF	Canceled
AUTO Psave (Auto power save)	AUTO Psave*	Setting
	Psave OFF	Canceled
D.L MODE 1 (Digital recording level)	D.L MODE 1*	Setting keep
	D.L MODE 2	Canceled

(*) indicates default setting.

■ Beep sound

You can eliminate the confirmation sound that beeps when you press a button.

■ Auto play

You can make the unit not play automatically when you insert a playback-only MiniDisc or an accidental erasure protected MiniDisc.

■ Auto power save

When the unit is used in a place exposed to much vibration, sound skipping can be decreased by canceling the auto power save function. (Battery will drain faster.)

What is auto power save function?

Auto power save function automatically adjusts the sound skip memory storage to be from 5 to 10 seconds depending on playback conditions, which saves battery power. If the MiniDisc unit is used in areas of much vibration, it may be necessary to fix the sound skip memory to 10 seconds "Psave OFF". This will improve performance under difficult conditions but uses more power. (When the AC/car adaptor is used, the 10 second mode is always used.)

■ Digital recording level

"D.L MODE 1"

The digital recording level you set will be kept even after canceling recording.



"D.L MODE 2"

Every time you cancel recording, the level will return to [D.L 0dB].

Titling a MiniDisc

■ Creating disc and track names

Load a MiniDisc to be named. A playback-only or recording prevented MiniDisc cannot be edited.

1	<Disc name>	<Track name>
	While in the stop mode, press the EDIT button to select "DISC NAME".	While in the pause mode, press the EDIT button to select "TRACK NAME".
	DISC NAME	TRACK NAME
2	Press the ENTER/SYNC button.	
	  AB 	
	Cursor	
	<ul style="list-style-type: none"> • The unit will enter the character input mode. • To cancel the operation, press the ■/OFF button. 	

3 Press the DISP button repeatedly to select the type of characters.

| select ABC |

ABC (Capital letters)	abc (Lower-case letters)	123 (Numbers and symbols)
--------------------------	-----------------------------	------------------------------

The first 3 characters in the group of the selected characters will be displayed for about 1 second.

4 Press the ◀◀ or ▶▶ button repeatedly to select the letter.

◀◀ | AB | — ◀◀ | ABC |

5 Press the ENTER/SYNC button to enter it.

| B ◀◀ | ◀◀ | ABC |

Position where the next letter will be entered

6 To enter more letters, repeat steps 3 - 5.

7 When the name has been completely entered, press the EDIT button.

8 "TOC" will be displayed. To write the updated contents to the MiniDisc, press the **■/:OFF button.**

You cannot remove the MiniDisc while "TOC" is displayed. "TOC" will not disappear until the recorded contents have been updated.

Note:

One disc name and up to 255 track names can be created per disc (a maximum of 100 characters for the disc and each track name and a total of 1,700 characters can be entered).

■ To erase a character

Press the VOL+ or VOL- button to move the cursor to the character you want to erase, and then press the BASS button.

■ To enter a space

Press the VOL+ button to move the cursor to the right.

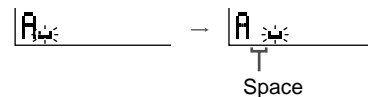

■ Characters (symbols)

Capital letters																											
<input type="checkbox"/>	<input type="checkbox"/>	<input type="checkbox"/>	<input type="checkbox"/>	<input type="checkbox"/>	<input type="checkbox"/>	<input type="checkbox"/>	<input type="checkbox"/>	<input type="checkbox"/>	<input type="checkbox"/>	<input type="checkbox"/>	<input type="checkbox"/>	<input type="checkbox"/>	<input type="checkbox"/>	<input type="checkbox"/>	<input type="checkbox"/>	<input type="checkbox"/>	<input type="checkbox"/>	<input type="checkbox"/>	<input type="checkbox"/>	<input type="checkbox"/>	<input type="checkbox"/>	<input type="checkbox"/>	<input type="checkbox"/>	<input type="checkbox"/>	<input type="checkbox"/>	<input type="checkbox"/>	
<input type="checkbox"/>	<input type="checkbox"/>	<input type="checkbox"/>	<input type="checkbox"/>	<input type="checkbox"/>	<input type="checkbox"/>	<input type="checkbox"/>	<input type="checkbox"/>	<input type="checkbox"/>	<input type="checkbox"/>	<input type="checkbox"/>	<input type="checkbox"/>	<input type="checkbox"/>	<input type="checkbox"/>	<input type="checkbox"/>	<input type="checkbox"/>	<input type="checkbox"/>	<input type="checkbox"/>	<input type="checkbox"/>	<input type="checkbox"/>	<input type="checkbox"/>	<input type="checkbox"/>	<input type="checkbox"/>	<input type="checkbox"/>	<input type="checkbox"/>	<input type="checkbox"/>	<input type="checkbox"/>	<input type="checkbox"/>
Lower-case letters																											
<input type="checkbox"/>	<input type="checkbox"/>	<input type="checkbox"/>	<input type="checkbox"/>	<input type="checkbox"/>	<input type="checkbox"/>	<input type="checkbox"/>	<input type="checkbox"/>	<input type="checkbox"/>	<input type="checkbox"/>	<input type="checkbox"/>	<input type="checkbox"/>	<input type="checkbox"/>	<input type="checkbox"/>	<input type="checkbox"/>	<input type="checkbox"/>	<input type="checkbox"/>	<input type="checkbox"/>	<input type="checkbox"/>	<input type="checkbox"/>	<input type="checkbox"/>	<input type="checkbox"/>	<input type="checkbox"/>	<input type="checkbox"/>	<input type="checkbox"/>	<input type="checkbox"/>	<input type="checkbox"/>	<input type="checkbox"/>
<input type="checkbox"/>	<input type="checkbox"/>	<input type="checkbox"/>	<input type="checkbox"/>	<input type="checkbox"/>	<input type="checkbox"/>	<input type="checkbox"/>	<input type="checkbox"/>	<input type="checkbox"/>	<input type="checkbox"/>	<input type="checkbox"/>	<input type="checkbox"/>	<input type="checkbox"/>	<input type="checkbox"/>	<input type="checkbox"/>	<input type="checkbox"/>	<input type="checkbox"/>	<input type="checkbox"/>	<input type="checkbox"/>	<input type="checkbox"/>	<input type="checkbox"/>	<input type="checkbox"/>	<input type="checkbox"/>	<input type="checkbox"/>	<input type="checkbox"/>	<input type="checkbox"/>	<input type="checkbox"/>	<input type="checkbox"/>
Numbers and symbols																											
<input type="checkbox"/>	<input type="checkbox"/>	<input type="checkbox"/>	<input type="checkbox"/>	<input type="checkbox"/>	<input type="checkbox"/>	<input type="checkbox"/>	<input type="checkbox"/>	<input type="checkbox"/>	<input type="checkbox"/>	<input type="checkbox"/>	<input type="checkbox"/>	<input type="checkbox"/>	<input type="checkbox"/>	<input type="checkbox"/>	<input type="checkbox"/>	<input type="checkbox"/>	<input type="checkbox"/>	<input type="checkbox"/>	<input type="checkbox"/>	<input type="checkbox"/>	<input type="checkbox"/>	<input type="checkbox"/>	<input type="checkbox"/>	<input type="checkbox"/>	<input type="checkbox"/>	<input type="checkbox"/>	<input type="checkbox"/>
<input type="checkbox"/>	<input type="checkbox"/>	<input type="checkbox"/>	<input type="checkbox"/>	<input type="checkbox"/>	<input type="checkbox"/>	<input type="checkbox"/>	<input type="checkbox"/>	<input type="checkbox"/>	<input type="checkbox"/>	<input type="checkbox"/>	<input type="checkbox"/>	<input type="checkbox"/>	<input type="checkbox"/>	<input type="checkbox"/>	<input type="checkbox"/>	<input type="checkbox"/>	<input type="checkbox"/>	<input type="checkbox"/>	<input type="checkbox"/>	<input type="checkbox"/>	<input type="checkbox"/>	<input type="checkbox"/>	<input type="checkbox"/>	<input type="checkbox"/>	<input type="checkbox"/>	<input type="checkbox"/>	<input type="checkbox"/>

: indicates a space.

Titling a MiniDisc (continued)

■ To add characters

1 Put the unit in the character input mode.

(Perform steps 1 - 2 on page 32.)

2 Press the VOL+ or VOL- button to move the cursor to the right of the character, where you want to add a new character.

BST « AB

3 Select the character to add.

(Perform steps 3 - 4 on page 32.)

4 Press the ENTER/SYNC button.

5 Press the EDIT button.

6 "TOC" will be displayed. To write the updated contents to the MiniDisc, press the ■:OFF button.

You cannot remove the MiniDisc while "TOC" is displayed. "TOC" will not disappear until the recorded contents have been updated.

■ Stamping titles from another MiniDisc

Before stamping

When there are 2 MiniDiscs on which the same tracks are recorded, you can transfer the character information (disc and track names) of the master MiniDisc to another MiniDisc (for stamping).

1. What is a master MiniDisc?

A recordable MiniDisc that contains tracks and character information. (You cannot transfer the information from a playback-only MiniDisc.)

2. What is a MiniDisc for stamping?

A MiniDisc that contains the same tracks in the same order as the master MiniDisc. (Make sure that the total number of tracks of the master MiniDisc and the one for stamping are the same.)

Master MiniDisc operation

1 Insert a master MiniDisc.

Do not mistake the master MiniDisc for the target one.

2 While in the stop mode, press the EDIT button to select "NAME STAMP".

NAME STAMP

3 Press the ENTER/SYNC button.

READ OK?

To cancel the operation, press the ■:OFF button.

4 Press the ENTER/SYNC button.

Reading! | CHANGE MD

5 When the unit displays "CHANGE MD", remove the master MiniDisc.

Remove it without turning off the power. Or, the operation will be canceled.

Operation of the MiniDisc for stamping

6 Load a MiniDisc for stamping.

INSERT MD | TOC READ
WRITE OK?

7 Press the ENTER/SYNC button.

Writing! | COMPLETE

The unit will finish recording the character information and enter the stop mode.

Note:

If the total number of tracks on the master MiniDisc does not match that on the MiniDisc for stamping, the unit will display "Can'tSTAMP" and turn off the power.

Can'tSTAMP

If this happens, adjust the total number of tracks on the newly recorded MiniDisc using the edit operation.

Editing a Recorded MiniDisc

■ To erase tracks one at a time

1 Start playing the track to be erased, and press the PLAY/PAUSE button.

2 Press the EDIT button repeatedly to select "ERASE".

ERASE 03

3 Press the ENTER/SYNC button.

ERASE 03?

To cancel the operation, press the ■/OFF button.

4 Press the ENTER/SYNC button again.

The track will be erased.

5 To erase other tracks, repeat steps 1 - 4.

■ To erase all of the tracks at once

1 While in the stop mode, press the EDIT button repeatedly to select "ALL ERASE".

ALL ERASE

2 Press the ENTER/SYNC button.

ERASE OK?

To cancel the operation, press the ■/OFF button.

3 Press the ENTER/SYNC button again.

BLANK MD

All of the tracks will be erased.

Caution:
Once a track has been erased, it cannot be recovered. Check the track number before erasing it.

■ To divide a track

1 Start playing the track to be divided into two. Press the PLAY/PAUSE button at the point where you want to divide the track.

2 Press the EDIT button repeatedly to select "DIVIDE".

DIVIDE

3 Press the ENTER/SYNC button.

DIVIDE OK?

To cancel the operation, press the ■:OFF button.

4 Press the ENTER/SYNC button again.

The track will be divided into two tracks, and the unit will pause at the beginning of the second of the two new tracks.

■ To combine tracks

1 Start playing the last of the two tracks to be combined, and press the PLAY/PAUSE button.

2 Press the EDIT button repeatedly to select "COMBINE".

COMBINE

3 Press the ENTER/SYNC button.

05+ 06 ?

To cancel the operation, press the ■:OFF button.

4 Press the ENTER/SYNC button.

The two tracks will be combined, and the unit will be paused at the beginning of the combined track.

Editing a Recorded MiniDisc (continued)

■ To move a track

1 Play the track to be moved, and press the PLAY/PAUSE button.

2 Press the EDIT button repeatedly to select "MOVE".

MOVE

3 Press the ENTER/SYNC button.

05→ 01 ?

To cancel the operation, press the ■/OFF button.

4 Press the ◀◀ or ▶▶ button to select the direction.

05→ 03 ?

5 Press the ENTER/SYNC button again.

The track will be moved, and the unit will be paused at the beginning of the track.

When a track has a name before dividing:

The two new tracks will have the same name. However, in the TOC FULL condition, the second track may not be named.

Total number of tracks that can be divided:

Each disc can hold up to 255 tracks. However, even if the number of assigned tracks has not reached 254, it might not be possible to make any further divisions of tracks.

To combine two non-adjacent tracks:

First, put the two tracks next to each other in the order you want using the MOVE function. Then combine them using the COMBINE function.

When one or both tracks to be combined have a name:

The first track name will be used. However, when the first track does not have a name, the second track name will be used.

In the following cases, tracks may not be combined.

- Digital recorded track and analog recorded track.
- Long play recorded track and stereo recorded track.
- Tracks whose recording time is less than 12 seconds.

Listening through Another System

■ Listening through a stereo system

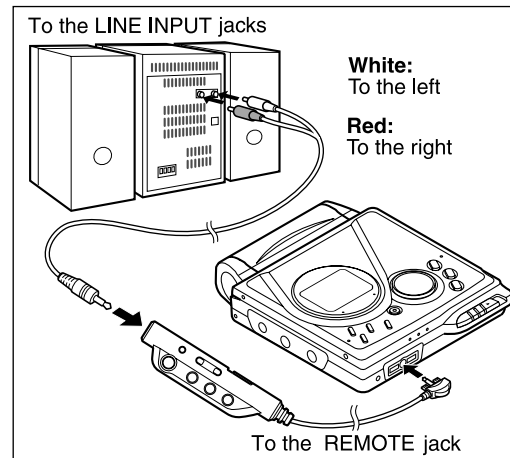

Notes:

- It is recommended that the volume level of the MiniDisc unit be set to maximum when listening through a stereo system.
- When recording with stereo system, eliminate the confirmation sound (page 31). Otherwise, it will also be recorded.
- The recording will be made in the analog mode.
- Character information will not be recorded.

■ Listening through a car stereo

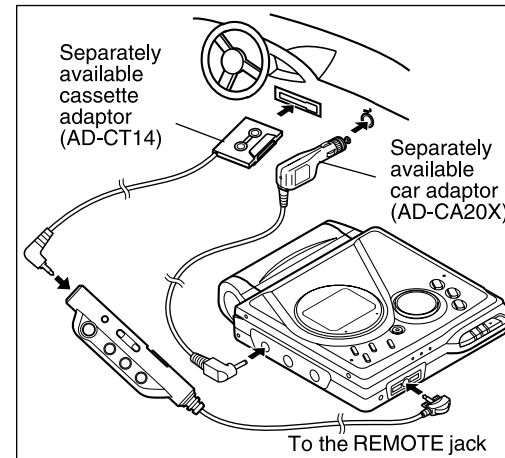

Notes:

- Adjust the volume of both this portable MD and a car stereo.
- Do not operate this portable MD while you drive a car. It may distract your attention and cause a traffic accident.
- Do not use any car adaptor except for the separately available AD-CA20X.
- Remove the battery when you power the unit from the car battery.

Other Features and Caution

■ Resuming auto play

When you stop playback and replay the MiniDisc without removing it, playback starts from the point you stopped it.

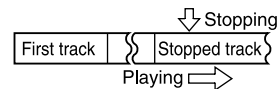

Once you remove the MiniDisc, playback starts from the first track.

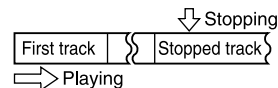

The unit provides the following functions when you use it with the separately available car adaptor (AD-CA20X) (when the rechargeable or alkaline battery is removed):

1. When you turn off the engine, the power of this portable MD also turns off. (It may not work with some types of cars.)
2. When you restart the engine, playback starts from the beginning of the stopped track.

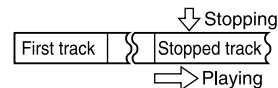

■ Rechargeable battery

- A rechargeable nickel-metal hydride battery is the only kind that can be used. Even if the battery is not used, you should charge it at least once every three months because of the special quality of this battery.
- The rechargeable battery can be charged approximately 300 times.
- When the operating time is reduced to about half the normal amount of time, even after a full charge is performed, replace the battery with a new one (AD-N70BT).
- When the battery is charged for the first time or is charged after not being used for a long period, the operating time may be shorter than normal. The battery life will recover with normal use i.e. charging and discharging.
- To avoid shortening the service life of the battery, only recharge the battery after it has been completely discharged.
- If the rechargeable battery is used in a cold environment, the operating time will be reduced.
- Do not carry the battery in your pocket or a bag together with metal objects (keys, coins, jewelry, etc.). The battery may short out and generate significant amounts of heat.
- Do not short-circuit the terminals as they will become very hot and will damage the battery.
- Do not drop or subject the battery to shock.
- Do not insert objects (metal etc.) into the battery compartment of this product or into the rechargeable battery.

MiniDisc System Limitations

The unit may have the following symptoms while recording or editing. The unit is not out of order.

SYMPTOM	LIMITATIONS
"DISC FULL" or "TOC FULL" appears even though the MiniDisc still has recording time left.	More than 255 tracks (maximum) cannot be recorded regardless of the recording time. If the MiniDisc is recorded or edited repeatedly or if it has scratches (recording skips scratched parts), you may not be able to record the maximum tracks above.
The remaining recording time does not increase even though you erased tracks.	The unit does not count non-recorded portions that last 12 or fewer seconds to display the remaining recording time. The time may not increase even if you erase short tracks.
The total of the recorded time and the remaining time does not match the maximum recordable time.	One cluster (approximately 2 seconds) is the minimum unit for recording. For example, a 3-second track uses 2 clusters (approximately 4 seconds). Therefore, the actual recordable time may be shorter than the displayed time.
Combine function does not work.	A MiniDisc on which recording and editing are repeated may not allow the combine function.
Sound skips in fast reverse/forward.	One track is divided and recorded in separate places on a repeatedly recorded or edited MiniDisc. Sound may skip.
A track number is created in the middle of a track.	A track number may be created if there are scratches or dust on the MiniDisc.

Error Messages

ERROR MESSAGES	MEANING	REMEDY
BATT EMPTY	<ul style="list-style-type: none"> The battery is run down. 	<ul style="list-style-type: none"> Charge the rechargeable battery or replace the alkaline battery (or use the AC adaptor for power).
BLANK MD	<ul style="list-style-type: none"> Nothing is recorded. 	<ul style="list-style-type: none"> Replace the disc with a recorded disc.
Can't COPY	<ul style="list-style-type: none"> You tried to record from a copy prohibited MiniDisc. 	<ul style="list-style-type: none"> Record using the analog cable.
Can't EDIT	<ul style="list-style-type: none"> A track cannot be edited. 	<ul style="list-style-type: none"> Change the stop position of the track and then edit it.
Can't READ (*)	<ul style="list-style-type: none"> The disc data cannot be read because the disc or unit is damaged. 	<ul style="list-style-type: none"> Reload the disc. Replace it with another recorded disc.
Can't REC	<ul style="list-style-type: none"> Recording cannot be performed correctly due to vibration or shock. 	<ul style="list-style-type: none"> Re-record or replace it with another recordable disc.
Can't STAMP	<ul style="list-style-type: none"> Stamp function does not work. 	<ul style="list-style-type: none"> Check the number of tracks.
Can't WRITE	<ul style="list-style-type: none"> Cannot save the TOC information correctly to a MiniDisc. (A large portion of the disc has been damaged.) 	<ul style="list-style-type: none"> Replace the disc with another recordable disc.
DEFECT	<ul style="list-style-type: none"> The disc is scratched. 	<ul style="list-style-type: none"> If the sound you hear is not right, record again. Replace the disc with another recordable disc.
DISC FULL	<ul style="list-style-type: none"> The disc is out of recording space. 	<ul style="list-style-type: none"> Replace it with another recordable disc.
Er-MD (**)	<ul style="list-style-type: none"> The microprocessor has reported a system fault and the unit is out of order. 	<ul style="list-style-type: none"> To have it repaired, go to the distributor where you purchased the unit.
HOLD	<ul style="list-style-type: none"> The unit is in the hold mode. 	<ul style="list-style-type: none"> Cancel the hold mode.
LOCKED	<ul style="list-style-type: none"> You removed a MiniDisc while recording or editing. 	<ul style="list-style-type: none"> Turn off the power and remove the MiniDisc.
NO DISC	<ul style="list-style-type: none"> A disc has not been loaded. 	<ul style="list-style-type: none"> Load a disc.

Number or symbol appears in (*) position.

NO SIGNAL	<ul style="list-style-type: none"> Poor connection of the digital cable. No output signal comes out from the connected unit to playback. The input signal has improper sampling frequency. 	<ul style="list-style-type: none"> Connect the digital cable securely. If the portable CD player has a function to prevent sound skips, deactivate it. Play back with the connected unit.
NOT PLAY	<ul style="list-style-type: none"> You tried to play back a track that cannot be played with this equipment. 	<ul style="list-style-type: none"> Play back another track.
PLAY MD	<ul style="list-style-type: none"> You recorded on a playback-only disc. 	<ul style="list-style-type: none"> Replace it with a recordable disc.
POWER ?	<ul style="list-style-type: none"> Improper power is being supplied. 	<ul style="list-style-type: none"> Use one of the specified power sources.
PROTECTED	<ul style="list-style-type: none"> The write protection tab of a MiniDisc is set to the protected position. You tried to record on a playback-only disc. 	<ul style="list-style-type: none"> Move the write protection tab back to its original position. Replace it with a recordable MiniDisc.
SORRY	<ul style="list-style-type: none"> Since a track number is currently being located or updated, the unit cannot accept your command. 	<ul style="list-style-type: none"> Wait for a while and try the operation again.
TEMP OVER	<ul style="list-style-type: none"> The temperature is too high. 	<ul style="list-style-type: none"> Turn off the power, and wait for a while.
TOC FORM (**)	<ul style="list-style-type: none"> There is an error in the recording signal. 	<ul style="list-style-type: none"> Erase all of the tracks, and then record again.
TOC FULL	<ul style="list-style-type: none"> There is no space left for recording character information (track names, disc names, etc.). 	<ul style="list-style-type: none"> Replace it with another recordable disc.
Tr. Protect	<ul style="list-style-type: none"> The track has been protected from being erased. 	<ul style="list-style-type: none"> Edit the track with the device on which it was recorded.
? DISC	<ul style="list-style-type: none"> A disc which contains data other than music was played. There is an error in the signal recorded on the disc. 	<ul style="list-style-type: none"> A disc which contains non-music data cannot be played. Replace it with another recorded disc.
Number or symbol appears in (*) position.		

Troubleshooting

Many potential "problems" can be resolved by the owner without calling a service technician. If something seems to be wrong with this product, check the following before calling your authorized SHARP dealer or service center.

PROBLEM	CAUSE
The unit does not turn on.	<ul style="list-style-type: none"> ● Is the AC adaptor disconnected? ● Is the battery exhausted? ● Is the unit in the hold mode? ● Has condensation formed inside the unit? ● Is the unit being influenced by mechanical shock or by static electricity?
No sound is heard from the headphones.	<ul style="list-style-type: none"> ● Is the volume set too low? ● Is the remote control unit or the headphones plugged in? ● Are you trying to play a MiniDisc with data on it instead of a MiniDisc containing music?
When the operation buttons are pressed, the unit does not respond.	<ul style="list-style-type: none"> ● Is the unit in the hold mode? ● Is the battery exhausted? ● Is the remote control unit plug or the headphones plug inserted firmly?
Some sounds are skipped.	<ul style="list-style-type: none"> ● Is the battery exhausted? ● Is the unit being subjected to excessive vibration?
The MiniDisc cannot be ejected.	<ul style="list-style-type: none"> ● Has the track number or character information been written on the disc yet? ● Is the unit in the recording or editing mode?
Recording and editing are impossible.	<ul style="list-style-type: none"> ● Is the MiniDisc protected against accidental erasure? ● Is the unit connected properly to the other equipment? ● Is the AC adaptor unplugged or did a power failure occur while recording or editing? ● Is the unit in the hold mode? ● Is an optical signal being output from the stereo system? Read the operation manual for the stereo system.

■ If trouble occurs

When this product is subjected to strong external interference (mechanical shock, excessive static electricity, abnormal supply voltage due to lightning, etc.) or if it is operated incorrectly, it may malfunction.

If such a problem occurs, do the following:

1. Unplug the AC adaptor from the AC outlet.
2. Remove the battery.
3. Leave the unit completely unpowered for approximately 30 seconds.
4. Plug the AC adaptor back into the AC outlet and re-operate the unit.

■ Moisture condensation

When the unit has condensation inside, the disc signals cannot be read, and the unit may not function properly.

In the following cases, condensation may form inside the unit.

- Shortly after turning on a heater.
- When the unit is placed in a room where there is excessive steam or moisture.
- When the unit is moved from a cool place to a warm place.

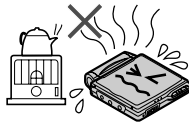

To remove condensation:

Remove the MiniDisc and leave the unit for approximately 1 hour. The condensation should evaporate and the unit will work properly.

Maintenance

■ Cleaning

When the unit becomes dirty

Clean it with a soft cloth. When the unit is excessively dirty, use a soft cloth dampened in water (external surfaces only).



Clean the plugs and the connecting jack.

If the plugs or jacks are dirty, noise may be heard. Cleaning will prevent noise.

Caution:

- Do not use chemicals for cleaning (gasoline, paint thinner, etc.). It may damage the cabinet finish.
- Do not apply oil to the inside of the unit. It may cause malfunctions.

Specifications

As a part of our policy of continuous improvement, SHARP reserves the right to make design and specification changes for product improvement without prior notice. The performance specification figures indicated are nominal values of production units. There may be some deviations from these values in individual units.

■ General

Power source:

DC 1.2V:	Rechargeable Nickel-Metal Hydride battery (AD-N70BT) x 1
DC 5V:	AC adaptor (AC 120V, 60 Hz)
DC 1.5V:	Commercially available, "AA" size (LR6), alkaline battery x 1
DC 4.5V:	Optional car adaptor, AD-CA20X(for cars with a 12 - 24V DC negative ground electrical system)

Power consumption: 7 W (AC adaptor)

Output power: RMS; 20 mW (10 mW + 10 mW) (0.2% T.H.D.)

Charging time: Approx. 3.5 hours (90 %)
Approx. 5.5 hours (fully charged)
(When using the AC adaptor included with the unit)

Battery life:

When using the rechargeable battery (fully charged) included with the unit	When using a commercially available, high capacity, "AA" size (LR6), alkaline battery
Continuous recording: Approx. 7 hours	Continuous recording: Approx. 3 hours
Continuous play: Approx. 12 hours	Continuous play: Approx. 12 hours

- The continuous recording time is for analog inputs when the volume level is set to "VOL 0".
- The continuous play time shows the value when the volume level is set to "VOL 15".
- The above values are the standard values when the unit is charged and used at an ambient temperature of 77°F (25°C).
- The operating time when using an alkaline battery may be different, depending on the type and manufacturer of the battery, and on the operating temperature.

Input sensitivity:

Recording level	Reference input level	Input impedance
MIC H	0.25 mV	10 k ohms
MIC L	2.5 mV	10 k ohms
LINE	100 mV	20 k ohms

Output level:

	Specified output	Maximum output level	Load impedance
Headphones	-	10 mW + 10 mW	16 ohms
LINE	250 mV (-12 dB)	-	10 k ohms

Dimensions: Width: 3-7/32" (81.1 mm)

Height: 13/16" (19.9 mm)

Depth: 3-21/32" (92.4 mm)

Weight: 0.38 lbs. (172 g) with rechargeable battery**Input jack:** Line/optical digital, microphone (powered by the main unit)**Output jack:** Headphones (impedance: 16 ohms)/remote control unit**■ MiniDisc Recorder****Type:** Portable MiniDisc recorder**Signal read-out:** Non-contact, 3-beam semiconductor laser pickup**Audio channels:** Stereo 2 channels/monaural (long-play mode) 1 channel**Frequency response:** 20 - 20,000 Hz (± 3 dB)**Rotation speed:** Approx. 400 - 900 rpm**Error correction:** ACIRC (Advanced Cross Interleave Reed-Solomon Code)**Coding:** ATRAC (Adaptive TRansform Acoustic Coding), 24-bit computed type**Recording method:** Magnetic modulation overwrite method**Sampling frequency:** 44.1 kHz (32 kHz and 48 kHz signals are converted to 44.1 kHz, and then recorded.)**Wow and flutter:** Unmeasurable (less than $\pm 0.001\%$ W. peak)



CONSUMER LIMITED WARRANTY

SHARP ELECTRONICS CORPORATION warrants to the first consumer purchaser that this Sharp brand product (the "Product"), when shipped in its original container, will be free from defective workmanship and materials, and agrees that it will, at its option, either repair the defect or replace the defective Product or part thereof with a new or remanufactured equivalent at no charge to the purchaser for parts or labor for the period(s) set forth below.

This warranty does not apply to any appearance items of the Product nor to the additional excluded item(s) set forth below nor to any Product the exterior of which has been damaged or defaced, which has been subjected to improper voltage or other misuse, abnormal service or handling, or which has been altered or modified in design or construction.

In order to enforce the rights under this limited warranty, the purchaser should follow the steps set forth below and provide proof of purchase to the servicer.

The limited warranty described herein is in addition to whatever implied warranties may be granted to purchasers by law. ALL IMPLIED WARRANTIES INCLUDING THE WARRANTIES OF MERCHANTABILITY AND FITNESS FOR USE ARE LIMITED TO THE PERIOD(S) FROM THE DATE OF PURCHASE SET FORTH BELOW. Some states do not allow limitations on how long an implied warranty lasts, so the above limitation may not apply to you.

Neither the sales personnel of the seller nor any other person is authorized to make any warranties other than those described herein, or to extend the duration of any warranties beyond the time period described herein on behalf of Sharp.

The warranties described herein shall be the sole and exclusive warranties granted by Sharp and shall be the sole and exclusive remedy available to the purchaser. Correction of defects, in the manner and for the period of time described herein, shall constitute complete fulfillment of all liabilities and responsibilities of Sharp to the purchaser with respect to the Product, and shall constitute full satisfaction of all claims, whether based on contract, negligence, strict liability or otherwise. In no event shall Sharp be liable, or in any way responsible, for any damages or defects in the Product which were caused by repairs or attempted repairs performed by anyone other than an authorized servicer. Nor shall Sharp be liable or in any way responsible for any incidental or consequential economic or property damage. Some states do not allow the exclusion of incidental or consequential damages, so the above exclusion may not apply to you.

THIS WARRANTY GIVES YOU SPECIFIC LEGAL RIGHTS. YOU MAY ALSO HAVE OTHER RIGHTS WHICH VARY FROM STATE TO STATE.

Model Specific Section

Your Product Model Number & Description:

MD-MT90 Portable MiniDisc Recorder

(Be sure to have this information available when you need service for your Product.)

Warranty Period for this Product:

One (1) year parts and ninety (90) days labor.

Additional Item(s) Excluded from Warranty Coverage (if any):

Non-functional accessories, supplies, and consumable items.

Where to Obtain Service:

At a Sharp Authorized Servicer located in the United States.

What to do to Obtain Service:

To find a location of the nearest Sharp Authorized Servicer, call Sharp toll free at 1-800-BE-SHARP.

Ship prepaid or carry in your Product to a Sharp Authorized Servicer.

Be sure to have **Proof of Purchase** available. If you ship the Product, be sure it is insured and packaged securely.

TO OBTAIN SUPPLY, ACCESSORY OR PRODUCT INFORMATION, CALL **1-800-BE-SHARP**.

SHARP

SHARP ELECTRONICS CORPORATION

Sharp Plaza, Mahwah, New Jersey 07430-2135

SHARP CORPORATION

Printed in Malaysia

A0101.TO

TINSE0355AWZZ

Free Manuals Download Website

<http://myh66.com>

<http://usermanuals.us>

<http://www.somanuals.com>

<http://www.4manuals.cc>

<http://www.manual-lib.com>

<http://www.404manual.com>

<http://www.luxmanual.com>

<http://aubethermostatmanual.com>

Golf course search by state

<http://golfingnear.com>

Email search by domain

<http://emailbydomain.com>

Auto manuals search

<http://auto.somanuals.com>

TV manuals search

<http://tv.somanuals.com>