



SHARP

OPERATION MANUAL with COOKBOOK



R-86STM MICROWAVE OVEN with TOP & BOTTOM GRILLS and CONVECTION

900W (IEC 60705)





OPERATION MANUAL

This operation manual contains important information which you should read carefully before using your microwave oven.

IMPORTANT:

There may be a serious risk to health if this operation manual is not followed or if the oven is modified so that it operates with the door open.

If you require any advice or assistance regarding your Sharp product, please visit our website:

www.sharp.co.uk/customersupport

Customers without Internet access may telephone:

08705 274277 (9am - 5pm)

(01) 676 0648 (from Ireland)



Attention: Your product is marked with this symbol. It means that used electrical and electronic products should not be mixed with general household waste. There is a separate collection system for these products.

A. Information on Disposal for Users (private households)

1. In the European Union

Attention: If you want to dispose of this equipment, please do not use the ordinary dust bin! Used electrical and electronic equipment must be treated separately and in accordance with legislation that requires proper treatment, recovery and recycling of used electrical and electronic equipment.

Following the implementation by member states private households within the EU states may return their used electrical and electronic equipment to designated collection facilities free of charge*.

In some countries* your local retailer may also take back your old product free of charge if you purchase a similar new one.

*) Please contact your local authority for further details.

If your used electrical or electronic equipment has batteries or accumulators, please dispose of these separately beforehand according to local requirements.

By disposing of this product correctly you will help ensure that the waste undergoes the necessary treatment, recovery and recycling and thus prevent potential negative effects on the environment and human health which could otherwise arise due to inappropriate waste handling.

2. In other Countries outside the EU

If you wish to discard this product, please contact your local authorities and ask for the correct method of disposal.

For Switzerland: Used electrical or electronic equipment can be returned free of charge to the dealer, even if you don't purchase a new product. Further collection facilities are listed on the homepage of www.swico.ch or www.sens.ch.

B. Information on Disposal for Business Users.

1. In the European Union

If the product is used for business purposes and you want to discard it:

Please contact your SHARP dealer who will inform you about the take-back of the product. You might be charged for the costs arising from take-back and recycling. Small products (and small amounts) might be taken back by your local collection facilities.

For Spain: Please contact the established collection system or your local authority for take-back of your used products.

2. In other Countries outside the EU

If you wish to discard of this product, please contact your local authorities and ask for the correct method of disposal.



CONTENTS

YOUR OVEN AND ACCESSORIES	2
CONTROL PANEL	3
SAFETY:	
Important Safety Instructions	4
Installation	4 - 5
OPERATION:	
Heating Category	6
How Your Oven Works	6
Before Operation	7
Microwave Power Levels	7
Setting the Clock	8
Energy Save Mode	9
How to Operate Your Oven	10 - 11
-Note for Reheating Ready Meals	10
-Note for Manual Cooking and Defrosting	11
Grill Cooking	12
Preheating the Oven	13
Convection Cooking	14
Combi Cooking	15 - 16
Express Cook / Express Defrost	17 - 19
Quick & Easy	20 - 21
Short Cuts	22 - 23
Auto Cook	24 - 26
Notes for Express Cook / Express Defrost / Quick & Easy / Short Cuts / Auto Cook	27
Weight Range for Express Cook / Express Defrost / Quick & Easy / Short Cuts / Auto Cook	27
Important Notes for Ready Meals	27
CONVENIENT FUNCTIONS:	
Sequence Cooking	28
Less and More	29
Kitchen Timer	30
Auto Minute	30
Information Guide	31
COOKING ADVICE:	
Microwave Cooking Advice	32 - 33
Suitable Cookware	34
Defrosting Advice	35
Reheating Advice	36
AFTERCARE:	
Cleaning and Maintenance	37
Troubleshooting	38 - 39
To Replace the Mains Plug	40
Calling for Service	40
COOKBOOK	41 - 67
GUARANTEE	68
SPECIFICATIONS	69

Quick guide for commonly cooked food.

MENU	WEIGHT	CONTAINER INSTRUCTION	COOKING INSTRUCTION	COOKING TIME/POWER LEVEL	STANDING TIME
Frozen Ready Meals (non-stirrable e.g. Lasagne)	400g	Flan dish on low rack	Place the ready meal in a heat-resistant flan dish on the low rack.	Stage1:1 minute on 100% Stage2:13 minutes on 50%	2 Minutes
Chilled Ready Meals (non-stirrable e.g. Lasagne)	400g	Flan dish on low rack	Place the ready meal in a heat-resistant flan dish on the low rack.	Stage1:2 minutes on 100% Stage2:4 minutes on 50%	2 Minutes
Jacket Potatoes (250g/9oz - each) (fresh)	2 Potatoes	Directly on turntable	Pierce in several places. Place on the edge of the turntable. Turn over halfway through cooking.	Stage1:5 minutes on 100% Stage2:5 minutes on 100%	5 Minutes
Defrost Minced Beef	500g	Flan dish on turntable	Place in a flan dish on the turntable. Turn over half way through cooking.	Stage1:2 minutes 45 secs on 30% Stage2:2 minutes 45 secs on 30%	15 - 30 Minutes





YOUR OVEN AND ACCESSORIES

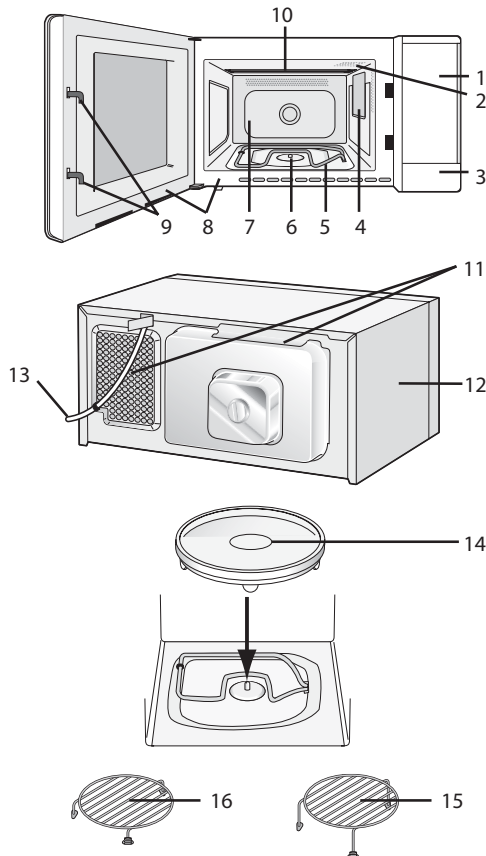

OVEN:

1. Control panel
2. Oven lamp
3. Door opening button
4. Waveguide cover (DO NOT REMOVE)
5. Bottom grill heating element
6. Turntable motor shaft
7. Oven cavity
8. Door seals and sealing surfaces
9. Door latches
10. Top grill heating element
11. Ventilation openings
12. Outer cabinet
13. Power cord

ACCESSORIES:

Check to make sure the following accessories are provided:

14. Turntable
15. High rack
16. Low rack

- Place the turntable on to the turntable motor shaft, ensuring it is located firmly.
- To avoid turntable damage, ensure dishes or containers are lifted clear of the turntable rim when removing them from the oven.
- For use of the racks, refer to the grill, convection and dual cooking sections on pages 12 to 16.

Never touch the grills when they are hot.

NOTES:

- The waveguide cover is fragile. Care should be taken when cleaning inside the oven to ensure that it is not damaged.
- After cooking fatty foods without a cover, always clean the cavity and especially the grill heating elements thoroughly, these must be dry and free from grease. Built-up grease may overheat and begin to smoke or catch fire.
- Always operate the oven with the turntable fitted correctly. This promotes thorough, even cooking. A badly fitted turntable may rattle, may not rotate properly and could cause damage to the oven.
- The turntable rotates clockwise or anti-clockwise. The rotary direction may change each time you start the oven. This does not affect cooking performance.
- When you order accessories, please quote both the **PART NAME** and **MODEL NUMBER** to your dealer or SHARP approved service facility. The model number is located at the bottom of the control panel.

⚠ Warning:

The door, outer cabinet, oven cavity, accessories, dishes and especially the grills will become very hot during operation. To prevent burns, always use thick oven gloves.





CONTROL PANEL

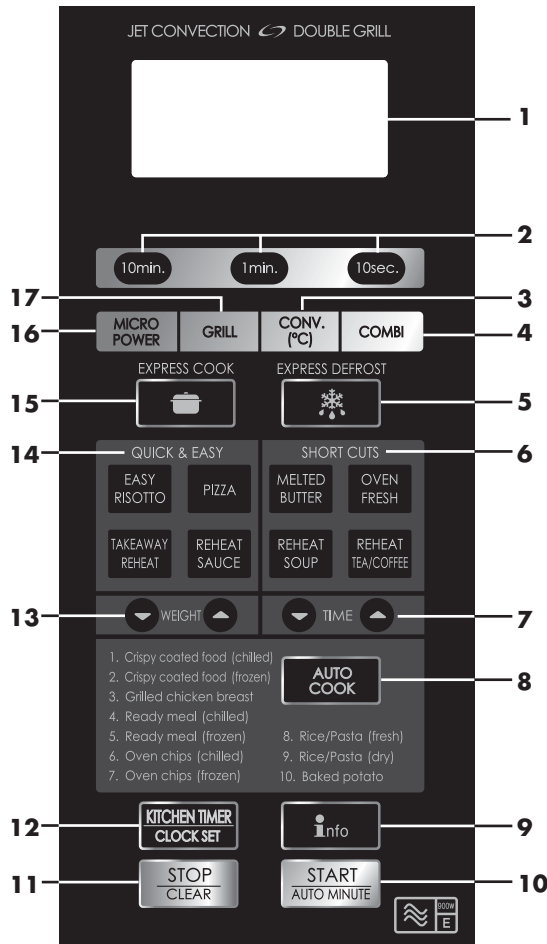

1. DIGITAL DISPLAY

KEYS:

- 2. TIME
- 3. CONV. (°C)
- 4. COMBI
- 5. EXPRESS DEFROST
- 6. SHORT CUTS (AUTO MENU)
- 7. TIME LESS/MORE
- 8. AUTO COOK
- 9. INFO
- 10. START/AUTO MINUTE
- 11. STOP/CLEAR
- 12. KITCHEN TIMER/CLOCK SET
- 13. WEIGHT UP/DOWN
- 14. QUICK & EASY (AUTO MENU)
- 15. EXPRESS COOK
- 16. MICRO POWER
- 17. GRILL

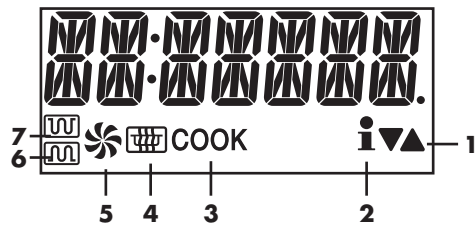

DIGITAL DISPLAY INDICATORS:

- 1. LESS/MORE
- 2. INFO
- 3. COOK
- 4. MICROWAVE
- 5. CONVECTION
- 6. BOTTOM GRILL
- 7. TOP GRILL

3





IMPORTANT SAFETY INSTRUCTIONS

PLEASE READ CAREFULLY AND KEEP FOR FUTURE REFERENCE

Oven Use:

- The oven is for domestic food use only.
- Never operate when empty, except as directed in the "Grill cooking" section on page 12.
- Do not leave or store anything inside the oven when not in use.
- Never attempt to use the oven with the door open. It is important not to force or tamper with the door safety latches.
- Never operate the oven with any object caught in the door.
- Do not insert fingers or objects in the holes of the door latches or air-vent openings as this may damage the oven and cause an electric shock.
- If water or food drops inside the air vent openings switch the oven off immediately, unplug it and call a SHARP approved service facility. (See page 40).
- Never move the oven while it is operating.
- The door, outer cabinet, oven cavity, turntable, dishes, accessories and especially the grill will become very hot during operation. Care should be taken to avoid touching these areas. To prevent burns, always use thick oven gloves. Before cleaning make sure they are not hot.

Pacemaker: If you have a heart pacemaker, consult your doctor or the pacemaker manufacturer prior to oven use.

WARNING: Only allow children to use the oven without supervision when adequate instructions have been given so that the child is able to use the oven in a safe way and understands the hazards of improper use.

When the appliance is operated in the **GRILL, CONVECTION, COMBI, EXPRESS COOK and PIZZA modes**, children should only use the oven under adult supervision due to the temperature generated.

Accessible parts may become hot during use. Young children should be kept away.

WARNING: Liquids and other foods must not be heated in sealed containers since they are liable to explode. Microwave heating of beverages can result in delayed eruptive boiling, therefore care has to be taken when handling the container. Stir the liquid prior to and during heating/ reheating, let liquid stand for at least 20 seconds in the oven after cooking.

FIRE: If smoke is observed, switch off and unplug the appliance and keep the door closed in order to stifle any flames.

INSTALLATION

WARNING

Inspect the Oven:

- Check the oven carefully for damage before and regularly after installation.
- Make sure the door closes properly, that it is not misaligned or warped.
- Check the hinges and door safety latches are not broken or loose.
- Ensure the door seal and sealing surfaces are not damaged. If the door or door seals are damaged, the oven must not be operated until it has been repaired by a competent person.
- Inspect the oven interior and door for dents.

IMPORTANT:

If any damage is apparent, do not operate the oven in any way, until it has been repaired by a SHARP trained engineer.

1. Remove all packing materials including the feature sticker (if applicable). The waveguide cover prevents food and grease from entering the waveguide area where it could cause damage. DO NOT REMOVE THE WAVEGUIDE COVER.
2. The oven door will become hot during cooking. Place or mount the oven so that the bottom of the oven is 85cm or more above the floor. Ensure the surface or mounting position is strong enough to take the oven weight, plus the heaviest item likely to be cooked in the oven.



INSTALLATION

- The minimum height of free space necessary above the top surface of the oven is 19cm.
- Do not place the oven where heat, moisture or high humidity are generated, (for example, near or above a conventional oven) or near combustible materials (for example, curtains). Do not block or obstruct air vent openings. Do not place objects on top of the oven.
- Make sure the power supply cord is undamaged (See "ELECTRICAL CONNECTION" below).
Do not allow the power supply cord to run over any hot or sharp surfaces, such as the hot air vent area at the top rear of the oven.
- The socket must be readily accessible so that it can be easily unplugged in an emergency.
- Do not use the oven outdoors.

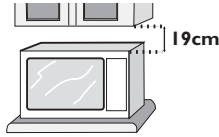

- If the plug fitted to your oven is a rewirable type and in the event of the socket outlet in your home not being compatible with the plug supplied, remove the plug properly (do not cut off).
- If the plug fitted to your oven is a non-rewirable type and in the event of the socket outlet in your home not being compatible with the plug supplied, cut-off the mains plug.
- Refit with a suitable type, observing the wiring code given in 'To replace the mains plug' on page 40.

WARNING: THIS APPLIANCE MUST BE EARTHED

To wire an appropriate plug, follow the wiring code given in 'To replace the mains plug' on page 40.

BUILDING-IN-KIT.

This oven is designed for counter top or built-in use. Do not place the oven in a cabinet. An installation frame is available which enables the microwave oven to be integrated within a kitchen unit. The microwave oven is not designed to be built above or near a conventional oven. SHARP recommend the use of the build in kit **EBR-47ST**, available from your SHARP dealer. Only the use of this frame will guarantee the quality and safety of the oven.

ELECTRICAL CONNECTION.

- Do not allow water to come into contact with the power supply cord or plug.
- Insert the plug properly into the socket.
- Do not connect other appliances to the same socket using an adaptor plug.
- If the power supply cord is damaged, it must be replaced by a SHARP approved service facility or a similarly qualified person to avoid a hazard.
- When removing the plug from the socket always grip the plug, never the cord as this may damage the power supply cord and the connections inside the plug.

IMPORTANT!

- The fuse from the cut-off plug should be removed and the plug disposed of in a safe manner.
- Under no circumstances should the cut-off plug be inserted into a socket outlet as a serious electric shock may occur.
- The plug must not be used without the fuse cover fitted.
- If you have any doubt about your microwave oven obtain the help of a qualified electrician.
- When replacing the plug please ensure that you use a BSI or ASTA approved plug to BS1363, this should be fitted with a brown coloured 13 amp fuse approved by BSI or ASTA to BS1362. If you have any doubt about electrical connection seek the help of a qualified electrician.



HEATING CATEGORY



Microwave Symbol.

Microwave output power in Watts (based on international (IEC 60705) standard).
Letter representing the oven heating category.

The heating category (a letter A to E) developed by MAFF (Ministry of Agriculture, Fisheries and Food) with microwave oven and food manufacturers indicates the ability of the oven to heat small quantities of food (up to 500g [1lb 2oz]). It does not represent the general performance of the oven.

OVEN OUTPUT POWER	Less heating time required 600 700 800 900 1000 Watts More heating time required
	OVEN OUTPUT CATEGORY
	Less heating time required A B C D E More heating time required

Food packs carry cooking instructions for heating categories A to E. Follow instructions for the letter corresponding to the oven's heating category. The higher the output power and heating category of the oven the less heating time is required as shown opposite.

HOW YOUR OVEN WORKS



Microwaves are energy waves, similar to those used for TV and radio signals. Electrical energy is converted into microwave energy, which is directed into the oven cavity via a waveguide. To prevent food and grease entering the wave guide it is protected by the waveguide cover. Microwaves cannot pass through metal, because of this the oven cavity is made of metal and there is a fine metal mesh on the door. During cooking the microwaves bounce off the sides of the oven cavity at random.

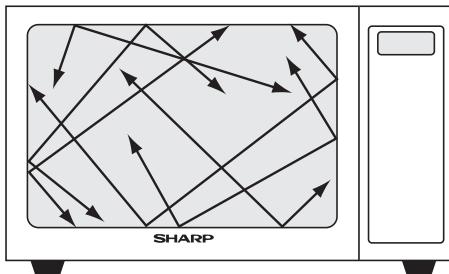

Microwaves will pass through certain materials, such as glass and plastic, to heat the food. (See 'Suitable Cookware' on page 34). Water, sugar and fat in food absorb microwaves which cause them to vibrate. This creates heat by friction, in the same way your hands get warm when you rub them together. The outer areas of the food are heated by the microwave energy, then the heat moves to the centre by conduction, as it does in conventional cooking. It is important to turn, rearrange or stir food to ensure even heating. Once cooking is complete, the oven automatically stops producing microwaves. Standing time is necessary after cooking, as it enables the heat to disperse equally throughout the food.





BEFORE OPERATION

Your oven comes pre-set in Energy Save Mode (see page 9 for details).

To operate the oven in Energy Save Mode:

1. Plug in the oven. Nothing will appear on the display at this time.
2. Open the door.
The display will flash:



3. Close the door.
The display will show:



NOTES: In Energy Save Mode, if you do not operate the oven for 3 minutes or more (i.e. after closing the door, pressing the **STOP/CLEAR** key, or at the end of cooking), you will not be able to operate the oven until you open and close the oven door.
When new, the very first time the grills are used, smoke and odour will be given off.
To avoid this happening when food is being cooked, heat the grills without food for approx. 20 minutes. (Please refer to note on page 12.)

MICROWAVE POWER LEVELS

Power Level	Press the MICRO POWER key	Percentage (Display)
HIGH	x 1	100% (100P)
MEDIUM HIGH	x 2	70% (70P)
MEDIUM	x 3	50% (50P)
MEDIUM LOW (Defrost)	x 4	30% (30P)
LOW (Defrost)	x 5	10% (10P)

- Your oven has 5 power levels, as shown opposite.
- To change the power level for cooking, enter the cooking time and then press the **MICRO POWER** key.

Power level:

The microwave power level is varied by the microwave energy switching on and off. When using power levels other than 100% you will be able to hear the microwave energy pulsing on and off as the food cooks or defrosts.

IMPORTANT: The microwave power level will cook at 100% unless you press the **MICRO POWER** key to the desired setting.

Check the power level:

To check the microwave power level during cooking, press the **MICRO POWER** key. As long as your finger is pressing the **MICRO POWER** key the power level will be displayed. The oven continues to count down although the display will show the power level.

MICRO
POWER

**MICRO POWER
KEY**



SETTING THE CLOCK

Your oven has a 12 hour clock.

- To select the 12 hour clock, press the **KITCHEN TIMER/CLOCK SET** key twice.



To set the time of day follow the instructions opposite.

NOTES:

- Press the **STOP/CLEAR** key if you make a mistake during programming.
- If you press any of the **TIME** keys too many times, continue to press the key until the desired time re-appears.
- To check the time of day during a cooking process, press the **KITCHEN TIMER/CLOCK SET** key and the time of day will remain on the display as long as you keep your finger on the key. This does not affect the cooking process.
- If the clock is set, when cooking is complete, the display will show the correct time of day. If the clock has not been set, the display will only show ".0" when cooking is complete.
- If the electrical power supply to your microwave oven is interrupted, the oven will be save energy mode automatically after the power is reinstated, and the display will show nothing until the door is opened. If this occurs during cooking, the programme will be erased. The time of day will also be erased.
- When you want to reset the time of day, follow the opposite example again.

- Select the clock.



- Enter the hours by pressing the **TIME** keys.



- Press the **KITCHEN TIMER/CLOCK SET** key once.



- Enter the minutes by pressing the **TIME** keys.



- To start the clock, press the **KITCHEN TIMER/ CLOCK SET** key once.





ENERGY SAVE MODE

Your oven has an Energy Save Mode. This facility saves electricity when the oven is not in use.

- If the oven is not used, it will default to Energy Save Mode after 3 minutes. The display is blank and the oven cannot be operated.
- To operate the oven, open and then close the door. ".0" will be displayed and the oven is ready to use.

To cancel Energy Save Mode, set the clock. (Please refer to page 8.)

To cancel the clock, follow the procedure opposite. (This will restart Energy Save Mode.)

NOTES:

- If you unplug your oven at any stage you will have to reset the clock to cancel Energy Save Mode.
- If the clock has been set, cancelling Energy Save Mode, then your oven has a safety feature which prevents **START/AUTO MINUTE** key from working if the oven has not been in use for more than 3 minutes. Press the **STOP/CLEAR** key or open and close the door to re-use the oven.

1. Time of day appears on the display.



2. Press the **KITCHEN TIMER/CLOCK SET** key 3 times.



3. Press the **START/AUTO MINUTE** key. The power will be off and the display will show nothing.





HOW TO OPERATE YOUR OVEN

Opening and closing the door:

To open the oven door, push the door opening button.

Starting the oven:

Close the door and press the **START/AUTO MINUTE** key.



Stopping the oven:

If you want to stop the oven during cooking, press the **STOP/CLEAR** key once or open the oven door.

If you want to cancel the cooking programme, press the **STOP/CLEAR** key twice.



Your oven enables you to cook and defrost food using the automatic programmes, or to cook and defrost food manually.

Automatic cooking and defrosting allows you to cook and defrost using preset programmes where the timings have been calculated for you, e.g **Express Cook** and **Express Defrost**.

Manual cooking and defrosting allows you to cook/defrost foods and weights which are not included in the automatic programmes. The following are examples of manual cooking and defrosting.

For automatic cooking and defrosting refer to pages 17 - 27.

MANUAL COOKING

- Enter the cooking time and use microwave power levels 10% to 100% to cook (refer to page 7).
- Stir or turn the food, where possible, 2 - 3 times during cooking, if required.
- After cooking, cover the food and leave to stand, if required.
- Refer to the cooking charts in the cookbook section, pages 43 - 48.

NOTE FOR REHEATING READY MEALS:

Place the ready meal in a heat-resistant flan dish on the low rack.

Example:

To cook for 2 minutes 30 seconds on 70% microwave power.

1. Enter the cooking time by pressing the **1 min.** key twice, then the **10 sec.** key three times.



2. Input the power level by pressing the **MICRO POWER** key twice.



3. Press the **START/AUTO MINUTE** key once to start cooking.



The display will count down through the cooking time.





HOW TO OPERATE YOUR OVEN

MANUAL DEFROSTING

- Enter the defrosting time and use microwave power levels 10% or 30% to defrost (refer to page 7).
- Stir or turn the food, where possible, 2 - 3 times during defrosting.
- After defrosting, cover the food in foil and leave to stand until thoroughly defrosted.
- Refer to the defrosting charts in the cookbook section, page 42.

NOTES FOR MANUAL COOKING AND DEFROSTING:

- When the oven starts, the oven lamp will light and the turntable will rotate clockwise or anti-clockwise.
- Your oven can be programmed up to 99 minutes, 90 seconds (99.90).
- If the door is opened during cooking/defrosting to stir or turn over food, the cooking time on the display stops automatically. The cooking/defrosting time starts to count down again when the door is closed and the **START/AUTO MINUTE** key is pressed.
- When cooking/defrosting is complete, the time of day will reappear on the display, if the clock has been set.
- If you want to know the power level during cooking, press the **MICRO POWER** key. As long as your finger is touching the key, the power level will be displayed.

Example:

To defrost for 10 minutes on 30% microwave power.

1. Enter the defrosting time by pressing the **10 min.** key once.



2. Input the power level by pressing the **MICRO POWER** key 4 times.



3. Press the **START/AUTO MINUTE** key once to start defrosting.



The display will count down through the defrosting time.



GRILL COOKING

The oven has top and bottom grills which can be used separately or combined. These have one power setting only. The grill is assisted by the turntable which rotates simultaneously to ensure even browning.

Use the racks for grilling small items of food such as bacon, gammon and teacakes, turn over halfway through grilling.

Food can be placed either directly onto the racks, or into a flan dish/heat-resistant plate on the high rack.

The grills required can be selected as follows:

Cooking Mode	Press GRILL key
GRILL-1 (Top Grill)	Once
GRILL-2 (Bottom Grill)	Twice
GRILL-3 (Top and Bottom Grill)	3 Times

NOTE: When new, the very first time the grills are used, smoke and odour will be given off.
To avoid this happening when food is being cooked, heat the grills without food for approx. 20 minutes.
When the oven has finished heating, open the door to cool the oven cavity.

NOTES:

- It is not necessary to preheat the grill before cooking.
- Follow the recommended grilling times and procedures in the charts on page 45 of the cookbook section.
- When browning foods in a deep container, place on the turntable or low rack.
- After cooking is complete the cooling fan will continue working for a short time to lower the temperature of the electrical and mechanical parts. The display may show "NOW COOLING".

⚠ WARNING:

The door, outer cabinet, oven cavity, accessories, dishes and especially the grills will become very hot during operation. To prevent burns, always use thick oven gloves.

Example:

To grill for 20 minutes, using GRILL-3.

1. Enter the cooking time by pressing the **10 min.** key twice.

10min. x2



2. Select GRILL-3 by pressing the **GRILL** key 3 times.

GRILL x3



3. Press the **START/AUTO MINUTE** key once to start grilling.

START
AUTO MINUTE x1



The display will count down through the grilling time.





PREHEATING THE OVEN

**CONV.
(°C)**

Your oven can be preheated to a desired temperature prior to convection cooking.

NOTES:

- When the oven reaches the desired temperature, the audible signal will sound and the temperature will be displayed in °C. **Do not press the STOP/CLEAR key after opening and closing the door, as this will cancel the Convection mode.**
- The preheated temperature will be maintained for approximately 30 minutes. After this time, preheat will be cancelled.
- During preheating and convection cooking, you will hear the cooling fan cycling on and off. This is completely normal and will not affect the cooking.
- You can check the actual temperature during preheating by pressing the **CONV. (°C)** key. The temperature will appear on the display. This will not affect the oven operation.
- If you prefer not to preheat the oven where recommended in the cookbook section, allow extra cooking time.

Example:

To preheat the oven to 180°C.

1. Enter the temperature by pressing the **CONV. (°C)** key 5 times.



2. Press the **START/AUTO MINUTE** key once to start preheating.



3. When the oven reaches 180°C, the audible signal will sound and the oven will display 180°C. Place food in the oven, enter the desired cooking time and press the **START/AUTO MINUTE** key.



WARNING:

The door, outer cabinet, oven cavity, accessories, dishes and especially the grills will become very hot during operation. To prevent burns, always use thick oven gloves.



CONVECTION COOKING

**CONV.
(°C)**

Your oven can be programmed to cook with ten different temperatures by combining the top and bottom grills with the convection fan. (Please refer to the notes below.)

The temperatures available in °C are:
**250°C, 230°C, 220°C, 200°C, 180°C,
160°C, 130°C, 100°C, 70°C, 40°C.**

- Convection cooking is ideal for roasting and baking.
- When using the **CONVECTION** key, all metal cookware can be used. (See 'Suitable Cookware' on page 34.)

NOTES:

- Follow convection times and procedures in the charts and recipes in the cookbook section.
- Food manufacturers instructions are only a guideline, so cooking times may need to be adjusted.
- Pressing the **CONV. (°C)** key during cooking will display the programmed temperature. This will not affect the programme or cooking time.
- Temperature measurements taken whilst the oven is in convection mode will differ from the displayed level. This is due to the grill elements turning on and off in order to regulate the oven temperature. This will not affect the cooking results as long as the operation manual and cookbook are followed correctly.
- After cooking is complete the cooling fan will continue working for a short time to lower the temperature of the electrical and mechanical parts. The display may show "NOW COOLING".
- Heat generated by the oven during convection cooking may cause the backplate of the oven to discolour. This is completely normal and will not affect the performance of the oven.
- This oven is not suitable for baking Yorkshire Puddings.

Example:

To cook for 20 minutes at 200°C convection.

1. Enter the cooking time by pressing the **10 min.** key twice.

10min. x2

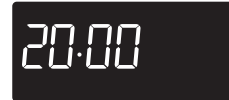

2. Input the temperature by pressing the **CONV. (°C)** key 4 times.

CONV.
(°C) x4



3. Press the **START/AUTO MINUTE** key once to start cooking.

START
AUTO MINUTE x1



The display will count down through the cooking time.

⚠ WARNING:

The door, outer cabinet, oven cavity, accessories, dishes and especially the grills will become very hot during operation. To prevent burns, always use thick oven gloves.





COMBI COOKING

COMBI

Combi combines microwave power with convection or grill.

The combination of microwave power with convection or grill reduces cooking time and provides a crisp, brown finish.

There are three Combi modes:

1. Combi-1 - Convection with microwave.
2. Combi-2 - Top grill with microwave.
3. Combi-3 - Bottom grill with microwave.

To select the combi cook mode required, enter the cooking time and follow the table below.

Cooking Mode	Press COMBI key
COMBI-1 (Convection and Microwave*)	Once
COMBI-2 (Top Grill and Microwave*)	Twice
COMBI-3 (Bottom Grill and Microwave*)	3 Times

NOTES:

- COMBI-1 is preset with 250°C convection. To adjust the convection temperature, press the **CONV. °C** key.
- Combi is preset with 30% microwave power. If you wish to change the microwave power level, press the **MICRO POWER** key until the desired power level is shown on the display. Combi 1: You can select 10%, 30% and 50%. Combi 2 & Combi 3: You can select 10%, 30%, 50%, 70% and 100%.

⚠ WARNING:

The door, outer cabinet, oven cavity, accessories, dishes and especially the grills will become very hot during operation. To prevent burns, always use thick oven gloves.

Example for Microwave and Convection:
To cook for 20 minutes using Combi-1, 230°C, 10% microwave power.

1. Enter the cooking time by pressing the **10min.** key twice



2. Select Combi-1 by pressing the **COMBI** key once.

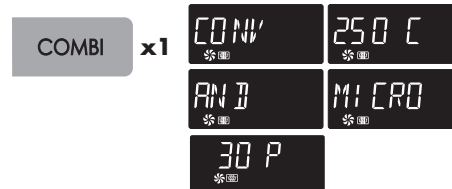

3. Change the temperature by pressing the **CONV. °C** key once.



4. Change the power level by pressing the **MICRO POWER** key once.



5. Press the **START/AUTO MINUTE** key once to start cooking.



The display will count down through the cooking time.





COMBI COOKING

Example for Microwave and Grill:

To cook for 15 minutes using Combi-2, 50% microwave power.

1. Enter the cooking time by pressing the **10 min.** key once and the **1 min.** key 5 times.



2. Select Combi-2 by pressing the **COMBI** key twice.



3. Change the power level by pressing the **MICRO POWER** key 4 times.



4. Press the **START/AUTO MINUTE** key once to start cooking.



The display will count down through the cooking time.

NOTES:

- For Combi-2 and Combi-3 it is not necessary to preheat the grill.
- Follow the recommended combi cooking times and procedures in the charts on pages 46 - 47.
- When browning foods in a deep container, place on the turntable or low rack.
- Temperature measurements taken whilst the oven is in convection mode will differ from the displayed level. This is due to the grill elements turning on and off in order to regulate the oven temperature. This will not affect the cooking results as long as the operation manual and cook book are followed correctly.
- After cooking is complete the cooling fan will continue working for a short time to lower the temperature of the electrical and mechanical parts. The display may show "NOW COOLING".

WARNING:

The door, outer cabinet, oven cavity, accessories, dishes and especially the grills will become very hot during operation. To prevent burns, always use thick oven gloves.



EXPRESS COOK / EXPRESS DEFROST

EXPRESS COOK enables you to cook 6 popular menus from frozen or chilled. Please refer to the chart on pages 18.
EXPRESS DEFROST enables you to defrost 4 popular menus. Please refer to the chart on page 19.

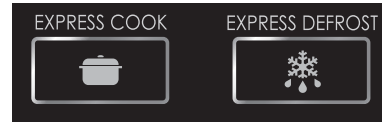

EXPRESS COOK Example:

To cook 0.6kg of Roast Beef from frozen.

1. Press the **EXPRESS COOK** key twice to select cooking from frozen.



2. Enter the weight by pressing the **WEIGHT UP** key once.



3. Press the **START/AUTO MINUTE** key once to start cooking.



The display will count down through the cooking time.

EXPRESS DEFROST Example:

To defrost a 1.2kg Whole Chicken.

1. Press the **EXPRESS DEFROST** key 3 times.



2. Enter the weight by pressing the **WEIGHT UP** key once.



3. Press the **START/AUTO MINUTE** key once to start defrosting.



The display will count down through the cooking time.

NOTES:



- You can enter the weight by holding down or pressing the **WEIGHT** key until the desired weight is displayed.
- If the **WEIGHT DOWN** key is pressed the display will count down from the highest weight range, each time the key is pressed.
- If the **WEIGHT UP** key is pressed the display will count up from the lowest weight range, each time the key is pressed.





EXPRESS COOK / EXPRESS DEFROST

EXPRESS COOK CHART

MENU	WEIGHT RANGE	COOKING PROCEDURE
Roast Beef/Lamb  x1: Chilled x2: Frozen	0.6kg - 1.8kg	<ul style="list-style-type: none"> Place meat in a flan dish on the low rack. After cooking, leave meat to stand wrapped in aluminium foil for 10 minutes. NOTES: <ul style="list-style-type: none"> Select MORE for well done. It is not possible to use the LESS key. For frozen beef: Turn over when the audible signal sounds.
Roast Pork  x3: Chilled x4: Frozen	0.6kg - 1.8kg	<ul style="list-style-type: none"> Place meat in a flan dish on the low rack. After cooking, leave meat to stand wrapped in aluminium foil for 10 minutes. NOTES: <ul style="list-style-type: none"> It is not possible to use the LESS key. For frozen pork: Turn over when the audible signal sounds.
Roast Chicken  x5: Chilled x6: Frozen	1.2kg - 1.8kg	<ul style="list-style-type: none"> Pierce skin (chilled only) a few times and place chicken, breast side up, in a flan dish on the low rack. After cooking, leave chicken to stand wrapped in aluminium foil for 10 minutes. NOTES: <ul style="list-style-type: none"> It is not possible to use the LESS key. This menu is only suitable for cooking whole chicken. For frozen chicken: Turn over when the audible signal sounds. When cooking frozen chicken with giblets, remove the giblets at first or second turn over.

See the notes on page 27.





⚠ WARNING:

The door, outer cabinet, oven cavity, accessories, dishes and especially the grills will become very hot during operation. To prevent burns, always use thick oven gloves.



EXPRESS COOK / EXPRESS DEFROST

EXPRESS DEFROST CHART

MENU	WEIGHT RANGE	COOKING PROCEDURE
Meat Joint: Beef/Lamb/Pork  x1	0.6kg - 1.8kg	<ul style="list-style-type: none">Place meat in a flan dish on the turntable.Turn meat over when the audible signal sounds.Stand, wrapped in foil, for 60 - 90 minutes until thoroughly defrosted.
Chicken Breast  x2	0.15kg - 0.80kg (1 piece= 150-200g)	<ul style="list-style-type: none">Place chicken breast, best side-up, in a flan dish on the turntable.Turn over and rearrange when the audible signal sounds.Stand, wrapped in foil, for 30 minutes until thoroughly defrosted.Rinse after standing
Whole Chicken  x3	1.2kg - 1.8kg	<ul style="list-style-type: none">Place chicken, breast side-up, in a flan dish on the turntable.Turn over when the audible signal sounds.Stand, wrapped in foil, for 60 - 90 minutes until thoroughly defrosted.
Minced Meat  x4	0.20kg - 1.00kg	<ul style="list-style-type: none">Place meat in a flan dish on the turntable.Turn meat over when the audible signal sounds.Stand, wrapped in foil, for 15-30 minutes until thoroughly defrosted.

See the notes on page 27.



QUICK & EASY

QUICK & EASY enables you to cook 4 popular menus.



For cooking instructions please refer to the chart on page 21.

Follow the example opposite for details on how to operate this function.

Example:

To cook 0.4 kg Frozen PIZZA

1. Select the menu required by pressing the **PIZZA** key twice.



2. Enter the weight by pressing the **WEIGHT UP** key 7 times.



3. Press the **START/AUTO MINUTE** key once to start cooking.







NOTES:

- You can enter the weight by holding down or pressing the **WEIGHT** key until the desired weight is displayed.
- If the **WEIGHT DOWN** key is pressed the display will count down from the highest weight range, each time the key is pressed.
- If the **WEIGHT UP** key is pressed the display will count up from the lowest weight range, each time the key is pressed.



QUICK & EASY

QUICK & EASY CHART

MENU	WEIGHT RANGE	COOKING INSTRUCTIONS
Easy Risotto 	1 serve (1 serve = approx 1.1kg.)	<ul style="list-style-type: none"> See the recipes on page 49. NOTE: <ul style="list-style-type: none"> It is not possible to use the LESS with this menu.
Pizza  x1: Chilled x2: Frozen	0.10kg - 0.90kg	<ul style="list-style-type: none"> Lightly grease the turntable with oil. Remove all packaging and place the food on the turntable. After cooking, remove from the turntable. NOTE: <ul style="list-style-type: none"> It is not recommended to cook bake and rise and stuffed crust pizza using this key.
Takeaway Reheat  x1: Chinese x2: Indian	0.30kg - 0.80kg	<ul style="list-style-type: none"> Remove any bread/pastry/crackers etc before cooking. Spread the take away evenly on a microwaveable plate. Cover with microwave cling film and pierce in 5 places. Place on the turntable. Stir when the audible signal sounds. After cooking, leave to stand for 2 minutes. NOTES: <ul style="list-style-type: none"> It is not possible to use the LESS with this menu. Ensure the left over take away is refrigerated as quickly as possible (ideally within one hour), and keep in the fridge for no more than 24 hours until reheating. Do not reheat the left over take away more than once. Ensure food is piping hot.
Reheat Sauce  x1: Room x2: Chilled x3: Frozen	0.15kg - 0.75kg	<ul style="list-style-type: none"> Place the food in a Pyrex ® bowl. Cover with microwave cling film and pierce in 5 places. Place on the turntable. Stir when the audible signal sounds. After cooking, stir. E.g. Pasta Cooking Sauce, Indian Cooking Sauce.

See the notes on page 27.

⚠ WARNING:
The door, outer cabinet, oven cavity, accessories, dishes and especially the grills will become very hot during operation. To prevent burns, always use thick oven gloves.





SHORT CUTS

SHORT CUTS enables you to easily cook 4 menus.



For cooking instructions please refer to the chart on page 23.

Example:

To reheat 0.5 kg Soup from Chilled

1. Select the menu required by pressing the **REHEAT SOUP** key twice.



2. Enter the weight by pressing the **WEIGHT UP** key 7 times.



3. Press the **START/AUTO MINUTE** key once to start cooking.







NOTES:

- You can enter the weight by holding down or pressing the **WEIGHT** key until the desired weight is displayed.
- If the **WEIGHT DOWN** key is pressed the display will count down from the highest weight range, each time the key is pressed.
- If the **WEIGHT UP** key is pressed the display will count up from the lowest weight range, each time the key is pressed.



SHORT CUTS

SHORT CUTS CHART

MENU	WEIGHT RANGE	COOKING INSTRUCTIONS
Melted Butter 	25 g - 100 g (25g = 1 portion)	<ul style="list-style-type: none"> Place the food in a Pyrex ® bowl. Cover with microwave cling film and pierce in 5 places. Place on the turntable. After cooking, stir.
Oven Fresh 	300ml boiling water 100ml lemon juice	<ul style="list-style-type: none"> Place boiling water into a 2 litre Pyrex ® bowl and add lemon juice. Do not cover. Place on the turntable. After heating, carefully remove the bowl from the oven and also remove the turntable. Wipe the cavity and door using a soft damp cloth. <p>NOTES:</p> <ul style="list-style-type: none"> It is not possible to use LESS or MORE with this menu. Do not use steam cleaners. Only use this function when the oven is completely at room temp (in case grills have been on and they are hot). Strong smells might not always be removed.
Reheat Soup  x1: Room x2: Chilled	0.20kg - 0.80kg	<ul style="list-style-type: none"> Place the food in a Pyrex ® bowl. Cover with microwave cling film and pierce in 5 places. Place on the turntable. Stir when the audible signal sounds. After cooking, stir. <p>NOTE:</p> <ul style="list-style-type: none"> Do not heat soup containing potatoes as they may explode.
Reheat Tea/Coffee 	1- 4 Cups (1 cup=200ml)	<ul style="list-style-type: none"> Do not cover. Place the cups towards the edge of the turntable. After cooking, stir.

See the notes on page 27.

⚠ WARNING:
The door, outer cabinet, oven cavity, accessories, dishes and especially the grills will become very hot during operation. To prevent burns, always use thick oven gloves.



AUTO COOK

AUTO COOK enables you to cook 10 popular menus.

1. Crispy coated food (chilled)	AUTO COOK
2. Crispy coated food (frozen)	
3. Grilled chicken breast	
4. Ready meal (chilled)	
5. Ready meal (frozen)	8. Rice/Pasta (fresh)
6. Oven chips (chilled)	9. Rice/Pasta (dry)
7. Oven chips (frozen)	10. Baked potato

For cooking instructions please refer to the chart on page 25 - 26.

Example:

To cook 0.3 kg Frozen Crispy coated Food

1. Select the menu required by pressing the **AUTO COOK** key twice.



2. Enter the weight by pressing the **WEIGHT UP** key 5 times.



3. Press the **START/AUTO MINUTE** key once to start cooking.











NOTES:

- You can enter the weight by holding down or pressing the **WEIGHT** key until the desired weight is displayed.
- If the **WEIGHT DOWN** key is pressed the display will count down from the highest weight range, each time the key is pressed.
- If the **WEIGHT UP** key is pressed the display will count up from the lowest weight range, each time the key is pressed.

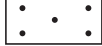

AUTO COOK

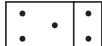
AUTO COOK CHART





MENU	WEIGHT RANGE	COOKING INSTRUCTIONS
Crispy Coated Food (chilled)  x1	0.10kg - 0.50kg	<ul style="list-style-type: none"> Place the food on the turntable. After cooking remove from the turntable and serve. E.g. fish cakes, fish goujons, chicken nuggets
Crispy Coated Food (frozen)  x2	0.10kg - 0.50kg	
Grilled Chicken Breast  x3	0.15kg - 0.80kg (1 piece=150-200g)	<ul style="list-style-type: none"> Pierce chicken skin several times with a skewer. Season with black pepper and place best side down in a flan dish on the low rack. Turn over when the audible signal sounds. After cooking leave to stand 5 minutes. <p>NOTE:</p> <ul style="list-style-type: none"> It is not possible to use the LESS key with this menu.
Ready Meal (chilled)  x4	0.30kg - 0.80kg	<ul style="list-style-type: none"> Read and follow the IMPORTANT NOTE FOR READY MEALS on page 27. For one section containers use a skewer to pierce film in 5 places.   For two section containers, pierce using a skewer.   <p>Pierce meat/main section 3 times and rice/pasta section twice.</p> <ul style="list-style-type: none"> For food contained in bag(s), pierce 5 times on one side. Cook pierced side-up. Where bags come already perforated, do not pierce. Place in a flan dish on the low rack. Stir, if possible, when the audible signal sounds. After cooking, leave to stand for 2 minutes before serving. <p>NOTES:</p> <ul style="list-style-type: none"> For stirrable foods, including food in bags, stir or manipulate contents when the audible signal sounds. For non-stirrable foods, use the MORE key. (It is not necessary to stir.) It is not possible to use the LESS key with these menus <p>Stirrable: E.g. Spaghetti bolognese, Beef stew</p> <p>Non-stirrable: E.g. Lasagne, Cottage pie</p>
Ready Meal (frozen)  x5	0.30kg - 0.80kg	

See the notes on page 27.



AUTO COOK

AUTO COOK CHART

MENU	WEIGHT RANGE	COOKING INSTRUCTIONS
Oven Chips (chilled)  x6	0.10kg - 0.40kg	<ul style="list-style-type: none"> Place the food on the turntable. After cooking remove from the turntable and serve.
Oven Chips (frozen)  x7	0.10kg - 0.40kg	
Rice/Pasta (fresh)  x8	0.2kg - 0.5kg	<ul style="list-style-type: none"> Place rice/pasta in an appropriate sized Pyrex[®] bowl. Add 300 ml (1/2 pint) of boiling water per 100 g rice/pasta. Do not cover. Place in the center of the turntable. Stir when the audible signal sounds. After cooking stir and leave to stand for 2 minutes, then drain and rinse in boiling water. E.g. filled pasta, spaghetti, fusilli
Rice/Pasta (dry)  x9	0.1kg - 0.3kg	
Baked Potato  x10	1 - 4 pieces (1 potato=approx. 250g)	<ul style="list-style-type: none"> Turntable should be in place during preheating and cooking. Pierce 3 times each side with skewer. Place in a flan dish on the low rack. Put in the oven when the audible signal sounds. Turn over when the audible signal sounds again. After cooking, leave to stand for 5 minutes.

See the notes on page 27.

⚠ WARNING:

The door, outer cabinet, oven cavity, accessories, dishes and especially the grills will become very hot during operation. To prevent burns, always use thick oven gloves.





NOTES FOR EXPRESS COOK / EXPRESS DEFROST / QUICK & EASY / SHORT CUTS / AUTO COOK:

- Chilled foods are cooked from 5°C.
- Frozen foods are cooked from -18°C.
- If using **MORE / LESS** press the key before pressing the **START/AUTO MINUTE** key.
- When action is required (e.g. turn food over), the oven stops, the audible signals sound and instructions will appear on the display. To continue cooking, press the **START/AUTO MINUTE** key.
- The final food temperature will vary according to the initial food temperature. Check food is thoroughly heated after cooking. If necessary, you can extend the cooking time manually.
- **EXPRESS COOK, QUICK & EASY** and **AUTO COOK** menus, except Easy Risotto, Takeaway Reheat, Reheat Sauce, Ready Meal, and Rice/Pasta, use a combination of microwave power and grill or convection.
- Before freezing foods, ensure food is fresh and of good quality.
- If necessary, shield small areas of meat or chicken with flat pieces of aluminium foil. This will prevent the areas from becoming warm during defrosting. Ensure the foil does not touch the oven walls.
- Do not cook meat or chicken unless it is thoroughly defrosted.
- Do not use the racks for defrosting.

WEIGHT RANGE FOR EXPRESS COOK / EXPRESS DEFROST / QUICK & EASY / SHORT CUTS / AUTO COOK:

- Weigh all meat and chicken prior to cooking/defrosting as the labelled weight is only approximate.
- Food weight should be rounded up to the nearest 0.1kg, for example, 0.65kg to 0.7kg.
Defrost Chicken Breast, Defrost Minced Meat, Pizza, Takeaway Reheat, Reheat Sauce, Reheat Soup, Crispy Coated Food, Grilled Chicken Breast, Ready Meal and Oven chips should be rounded up to the nearest 0.05kg, for example, 0.34kg to 0.35kg.
Melted Butter should be rounded up to the nearest 25g, for example, 70g to 75g.
- **You are restricted to cook/defrost the weight given in the charts.**
- To cook/defrost weights or foods not included in these charts, cook manually.
- For converting to lb/oz see the conversion chart on page 41.

IMPORTANT NOTES FOR READY MEALS:

- These menus are suitable for savoury microwave ready meals only.
- You must only cook one microwave ready meal at a time.
- These menus are not suitable for non-stirrable ready meals e.g. lasagne, cottage pie etc.
- Always check food is thoroughly heated before serving, if necessary increase cooking time, using 70P microwave power level and check the food every minute.
- Remove outer cardboard packaging as instructed by the manufacturer.
- If the food container is made of aluminium foil, remove the food and place in suitable container, cover with microwave cling film and pierce in 5 places before heating. (See 'Suitable Cookware' on page 34.)
- If the container is covered with aluminium foil, remove foil, re-cover with microwave cling film and pierce 5 times.

⚠ WARNING:
The door, outer cabinet, oven cavity, accessories, dishes and especially the grills will become very hot during operation. To prevent burns, always use thick oven gloves.





CONVENIENT FUNCTIONS

1. SEQUENCE COOKING

This function allows you to cook using up to 4 manual cooking programmes. For grill, convection and combi cooking modes, you can programme up to 2 stages in one sequence setting.

Once programmed the oven will automatically move onto the next stage.

Example:

To cook for:

5 minutes on 70% microwave power (Stage 1)

6 minutes on Grill-1 (Stage 2)

3 minutes on Combi-1, 200°C,
30% microwave power (Stage 3)

STAGE 1

1. Enter the cooking time by pressing the **1 min.** key 5 times.



2. Input the power level by pressing the **MICRO POWER** key twice.



STAGE 2

3. Enter the cooking time by pressing the **1 min.** key 6 times.



4. Select Grill-1 by pressing the **GRILL** key once.



STAGE 3

5. Enter the cooking time by pressing the **1 min.** key 3 times.



6. Select Combi-1 by pressing the **COMBI** key once, then change the convection temperature by pressing the **CONV. °C** key 3 times.

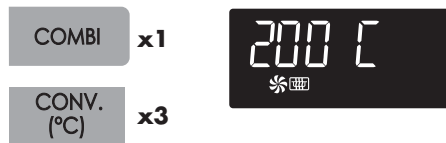

7. Press the **START/AUTO MINUTE** key once to start cooking.



NOTE: If 100% is required on the final stage, it is not necessary to input the power level.

⚠ WARNING:

The door, outer cabinet, oven cavity, accessories, dishes and especially the grills will become very hot during operation. To prevent burns, always use thick oven gloves.





CONVENIENT FUNCTIONS

2. LESS and MORE

The **LESS (▼)** and **MORE (▲)** keys enable you to:

- Cook/defrost food for less or more time than the automatic programmes.
- Decrease or increase cooking/defrosting time whilst the oven is in use during manual cooking.

TO USE WITH MANUAL COOKING:

Example:

To cook for 10 minutes on 50% microwave power and then decrease the cooking time by 2 minutes.

1. Enter the cooking time by pressing the **10 min.** key once.



2. Input the power level by pressing the **MICRO POWER** key 3 times.



3. Press the **START/AUTO MINUTE** key once to start cooking.



4. Reduce the cooking time by pressing the **LESS** key twice.



The cooking time is reduced by 2 minutes and continues to count down.

NOTES:

- The cooking/defrosting time will increase/decrease in multiples of 1 minute.
- The overall time can be extended to a maximum of 99 minutes.

TO USE WITH AUTOMATIC PROGRAMMES:

Press the **LESS (▼)** / **MORE (▲)** key before pressing the **START/AUTO MINUTE** key.

Example:

If you prefer Roast Chicken well cooked, use the **MORE (▲)** key.

NOTES:

- If you select MORE the display will show, (▲).
- If you select LESS, the display will show, (▼).
- Some menus do not have the LESS function and if you select LESS and then press **START/AUTO MINUTE** key:



will be displayed.

- To cancel LESS / MORE, press the same key again.
- To change MORE to LESS, press the **LESS (▼)** key.
- To change LESS to MORE, press the **MORE (▲)** key.



CONVENIENT FUNCTIONS

3. KITCHEN TIMER

Use the KITCHEN TIMER as a minute timer or to monitor the standing time for cooked/defrosted food.

NOTES:

- You can enter any time up to 99 minutes, 90 seconds.
- This function does not interrupt even if the door is opened.
- The KITCHEN TIMER function cannot be used whilst the oven is in use.
- To cancel the KITCHEN TIMER simply press the **STOP/CLEAR** key and the display will return to the time of day, if set.

Example:

To set the timer for 5 minutes.

1. Press the **KITCHEN TIMER** key once.



2. Enter the desired time by pressing the **1 min.** key 5 times.



3. Press the **START/AUTO MINUTE** key once to start the timer.



4. AUTO MINUTE

AUTO MINUTE enables you:

- To cook on 100% microwave power in multiples of 1 minute.
You can use this function only within 3 minutes after cooking completion, closing the door or pressing the **STOP/CLEAR** key.
- To extend cooking time during manual cooking in multiples of 1 minute.

NOTE:

- The overall time can be extended to a maximum of 99 minutes.

Example:

To cook for 2 minutes on 100% microwave power, press the **START/AUTO MINUTE** key twice.





CONVENIENT FUNCTIONS

5. INFORMATION GUIDE

The **INFO** key provides step-by-step information on the oven, and also cooking help.



A. GUIDE OF KEYS: displays information about the key pressed.

Example:

To display the information for EXPRESS COOK "Frozen Roast Pork".

1. Press the **INFO** key once.

Info will appear on the display.



2. Press the **EXPRESS COOK** key 4 times key once to select Frozen Roast Pork.



NOTES:

- The display will flash a series of messages, including the weight range and any action required during cooking.
- The message will be repeated twice, then the display will return to the time of day, if set.
- If you want to cancel the guide, press the **STOP/CLEAR** key.

B. COOKING HELP: displays a cooking hint when using EXPRESS COOK, EXPRESS DEFROST, QUICK & EASY, SHORT CUTS and AUTO COOK.

Whenever INFO is lit in the display, you can press the INFO key to see the cooking hint.



MICROWAVE COOKING ADVICE

Microwaves cook food faster than conventional cooking. It is therefore essential that certain techniques are followed to ensure good results. Many of the following techniques are similar to those used in conventional cooking.

COOKING ADVICE NOTES:

- **Always attend the oven when in use.**
- **Ensure that the utensils are suitable for use in a microwave oven. (See 'Suitable Cookware' on page 34.)**
- Refer to the charts in the cookbook section for recommended cooking times and power levels.
- Do not place hot foods/utensils on a cold turntable or cold foods/utensils on a hot turntable.

WARNING:

Liquids and foods must not be heated in sealed containers or jars/containers with lids on, as pressure will build up inside and may cause the jar/container to explode.



- Only use microwave popcorn within the recommended packaging (follow the manufacturers instructions). Never use oil unless specified by the manufacturer and never cook for longer than instructed.



WARNING:

Follow instructions in the SHARP operation manual at all times. If you exceed recommended cooking times and use power levels that are too high, food may overheat, burn and, in extreme circumstances, catch fire and damage the oven.

Cooking Techniques

Arrange	Place the thickest parts of food towards the outside of the dish, e.g. Chicken drumsticks. Foods that are placed towards the outside of the dish will receive more energy, so cook quicker, than those in the centre.	
Cover	Certain foods benefit from being covered during microwave cooking, follow recommendations where given. Use vented microwave cling film or a suitable lid.	
Pierce	Foods with a shell, skin or membrane must be pierced in several places before cooking or reheating as steam will build up and may cause food to explode, e.g. Potatoes, Fish, Chicken, Sausages.	
	NOTE: Eggs in their shells and hard / soft boiled eggs should not be heated in the microwave oven as they may explode, even after cooking has ended.	
Stir, turn and rearrange	For even cooking it is essential to stir, turn and rearrange food during cooking. Always stir and rearrange from the outside towards the centre.	
Stand	Standing time is necessary after cooking so it enables the heat to disperse equally throughout the food.	





MICROWAVE COOKING ADVICE

Food Characteristics	
Composition	Foods high in fat or sugar (e.g. Christmas pudding, mince pies) require less heating time. Care should be taken as overheating can lead to fire. Bones in food conduct heat, making the food cook more quickly. Care must be taken so that the food is cooked evenly.
Density	Food density will affect the amount of cooking time needed. Light porous foods, such as cakes or bread, cook more quickly than heavy, dense foods, such as roasts and casseroles.
Quantity	The number of microwaves in your oven remains the same regardless of how much food is being cooked. The cooking time must be increased as the amount of food placed in the oven increases, e.g. four potatoes will take longer to cook than two.
Size	Small foods and small pieces cook faster than large ones, as microwaves can penetrate from all sides to the centre. For even cooking make all the pieces the same size.
Shape	Foods which are irregular in shape, such as chicken breasts or drumsticks, take longer to cook in the thicker parts. For even cooking, place the thickest parts to the outside of the dish where they will receive more energy. Round shapes cook more evenly than square shapes when microwave cooking.
Temperature of food	The initial temperature of food affects the amount of cooking time needed. Chilled foods will take longer to cook than food at room temperature, e.g. a cake made with chilled ingredients, will take longer to cook than cake made with ingredients at room temperature. The temperature of the container is not a true indication of the temperature of the food or drink. Cut into foods with fillings, for example jam doughnuts, to release heat or steam.



Face & Hands: Always use oven gloves to remove food or cookware from the oven. Stand back when opening the oven door to allow heat or steam to disperse. When removing covers (such as cling film), opening roasting bags or popcorn packaging, direct steam away from face and hands.



Check the temperature of food and drink and stir before serving. Take special care when serving to babies, children or the elderly. The contents of feeding bottles and baby food jars are to be stirred or shaken and the temperature is to be checked before consumption to avoid burns.





SUITABLE COOKWARE

To cook/defrost food in a microwave oven, the microwave energy must be able to pass through the container to penetrate the food. Therefore it is important to choose suitable cookware. Round/oval dishes are preferable to square/oblong ones, as the food in the corners tends to overcook. A variety of cookware can be used as listed below.

Cookware	Microwave Safe	Grill	Combi Cook	Convection	Comments
Aluminium foil Foil Containers	✓ / ✗	✓	✓ / ✗	✓	Small pieces of aluminium foil can be used to shield food from overheating. Keep foil at least 2cm from the oven walls, as arcing may occur. Foil containers are not recommended unless specified by the manufacturer, e.g. Microfoil ®, follow instructions carefully.
Browning dishes	✓	✗	✗	✗	Always follow the manufacturers instructions. Do not exceed heating times given. Be very careful as these dishes become very hot.
China and ceramics	✓ / ✗	✗	✓ Combi-1 only	✓	Porcelain, pottery, glazed earthenware and bone china are usually suitable, except for those with metallic decoration.
Glassware e.g. Pyrex ®	✓	✓	✓	✓	Care should be taken if using fine glassware as it can break or crack if heated suddenly.
Metal	✗	✓	✗	✓	It is not recommended to use metal cookware when using microwave power as it will arc, which can lead to fire.
Plastic/ Polystyrene E.g. fast food containers	✓	✗	✗	✓ / ✗	Care must be taken as some containers warp, melt or discolour at high temperatures.
Cling film	✓	✗	✗	✗	Should not touch the food and must be pierced to let the steam escape.
Freezer/Roasting bags	✓	✗	✗	✓ / ✗	Must be pierced to let steam escape. Ensure bags are suitable for microwave or convection use. Do not use plastic or metal ties, as they may melt or catch fire due to the metal arcing.
Paper plates/ cups and kitchen paper	✓	✗	✗	✗	Only use for warming or to absorb moisture. Care must be taken as overheating may cause fire.
Straw and wooden containers	✓	✗	✗	✗	Always attend the oven when using these materials as overheating may cause fire.
Recycled paper and newspaper	✗	✗	✗	✗	May contain extracts of metal which will cause 'arcing' and may lead to fire.
Racks	✓	✓	✓	✓	The metal racks supplied have been specially designed for all cooking modes and will not damage the oven.



WARNING: When heating food in plastic or paper containers, monitor the oven due to the possibility of ignition.





DEFROSTING ADVICE

Using your microwave is a very efficient method of defrosting. It is a simple process but the following instructions are essential to ensure the food is thoroughly defrosted.

Rearrange	Foods that are placed towards the outside of the dish will defrost quicker than foods in the centre. It is therefore essential that the food is rearranged up to 4 times during defrosting. Move closely packed pieces from the outside to the centre and rearrange over-lapping areas. This will ensure that all parts of the food defrosts evenly.
Separate	Foods may be stuck together when removed from the freezer. It is important to separate foods as soon as it is possible during defrosting, e.g. bacon rashers, chicken fillets.
Shield	Some areas of food being defrosted may become warm. To prevent them becoming warmer and starting to cook, these areas can be shielded with small pieces of foil, which reflect microwaves, e.g. legs and wings on a chicken.
Stand	Standing time is necessary to ensure food is thoroughly defrosted. Defrosting is not complete once the food is removed from the microwave oven. Food must stand, covered, for a length of time to ensure the centre has completely defrosted.
Turn over	It is essential that all foods are turned over at least 3 - 4 times during defrosting. This is important to ensure thorough defrosting.

NOTES:

- Remove all packaging and wrapping before defrosting.
- To defrost food, use microwave power levels 30% or 10%.
- Please refer to the defrosting chart on page 42 for further information.



REHEATING ADVICE

Follow the advice and guidelines below to ensure food is thoroughly reheated before serving:

Plated meals	<p>Remove poultry or meat portions, reheat these separately, see below.</p> <p>Place smaller items of food to the centre of the plate, larger and thicker foods to the edge. Cover with vented microwave cling film and reheat on 50%, stir/rearrange halfway through reheating.</p> <p>NOTE: Ensure the food is thoroughly reheated before serving.</p>	
Sliced meat	<p>Cover with vented microwave cling film and reheat on 50%. Rearrange at least once to ensure even reheating.</p> <p>NOTE: Ensure the meat is thoroughly reheated before serving.</p>	
Poultry portions	<p>Place thickest parts of the portions to the outside of the dish, cover with vented microwave cling film and reheat on 70%.</p> <p>Turn over halfway through reheating.</p> <p>NOTE: Ensure the poultry is thoroughly reheated before serving.</p>	
Casseroles	<p>Cover with vented microwave cling film or a suitable lid and reheat on 50%.</p> <p>Stir frequently to ensure even reheating.</p> <p>NOTE: Ensure the food is thoroughly reheated before serving.</p>	

To achieve the best results when reheating, select a suitable microwave power level appropriate to the type of food.

NOTES:

- Remove food from foil or metal containers before reheating.
- Reheating times will be affected by the shape, depth, quantity and temperature of food together with the size, shape and material of the container.



Never heat liquids in narrow-necked containers, as this could result in the contents erupting from the container and may cause burns.

- To avoid overheating and fire, special care must be taken when reheating foods with a high sugar or fat content, e.g. mince pies or Christmas pudding.
- Never heat oil or fat for deep frying as this may lead to overheating and fire.
- Canned potatoes should not be heated in the microwave oven, follow the manufacturer's instructions on the can.



The contents of feeding bottles and baby food jars are to be stirred or shaken and the temperature is to be checked before consumption to avoid burns.





CLEANING & MAINTENANCE

OVEN INTERIOR

- It is important to clean the interior of your microwave oven after each use.
- To clean the oven interior, use a mild detergent solution, such as washing-up liquid, with warm water on a soft cloth.
- Heat up your oven regularly by using the grill, refer to NOTE on page 12. Remaining food or fat splashed can cause smoke or bad smell.
- Food and liquid splashes will build-up on the oven walls and ceiling. If grease, fat and food debris is allowed to build-up in the oven interior it may overheat, smoke or even catch fire when next using the oven.
- Keep the **waveguide cover** clean at all times. The waveguide cover is constructed from a fragile material and should be cleaned with care (follow the cleaning instructions above).

NOTE: Excessive soaking may cause disintegration of the waveguide cover. The waveguide cover is a consumable part and without regular cleaning, will need to be replaced.

- Food will release steam during cooking and cause condensation inside the oven and door. It is important to wipe the oven dry. A build-up of condensation will eventually lead to rust forming on the oven interior.
- **Do not allow grease or dirt to build-up on the door seals or areas around the door. This may prevent the door from closing correctly and may cause a leakage of microwaves (follow the cleaning instructions opposite).**

NOTES:

- Never use spray cleaners, oven pads or abrasive scourers as these damage the surface of the oven.
- A steam cleaner should not be used.
- Take care not to let soapy water drip through the small holes in the oven walls and the cavity floor. Excess water spillage through these holes will cause damage to the oven interior.
- Slight tarnishing of the oven cavity, around the area of the grills, is likely to occur. This is normal and will not affect the ovens performance.

WARNING:

Before cleaning, make sure the oven cavity, door, oven cabinet, accessories and especially the grills are completely cool.

- Ensure the accessories are cleaned after every use with a mild washing-up liquid solution and dried. This will prevent the build-up of grease and food debris.

The accessories are dishwasher safe.

- **Clean the oven at regular intervals and remove any food deposits. Failure to maintain the oven in a clean condition could lead to a deterioration of the surface that could adversely affect the life of the appliance and possibly result in a hazardous situation.**

OUTER CABINET

- Wipe the outside of the microwave oven with a mild detergent solution, such as washing-up liquid, with warm water on a soft cloth.
- The control panel must be wiped clean and dried with the door open, therefore inactivating the oven.

DOOR

- To remove all trace of dirt, regularly clean both sides of the door, the door seals and adjacent parts with a soft, damp cloth.
- Do not use harsh abrasive cleaners or sharp metal scrapers to clean the oven door glass since they can scratch the surface, which may result in shattering of the glass.



TROUBLESHOOTING

If you think the oven is not working properly there are some simple checks you can carry out yourself before calling an engineer. This will help prevent unnecessary service calls if the fault is something simple.

Follow this simple check below:

Place half a cup of water on the turntable and close the door. Programme the oven to cook for 1 minute using 100% microwave power.

1. Does the oven lamp come on when it is cooking?
2. Does the turntable rotate?
3. Does the cooling fan work? (Check by placing your hand above the air vent openings.)
4. After 1 minute does the audible signal sound?
5. Is the water in the cup hot?

Take the cup of water out of the oven and close the door. Programme the oven to cook for 3 minutes using the top and bottom grills.

6. After 3 minutes, do both the grill heating elements become red?

Programme the oven to cook for 3 minutes using the convection on 250°C.

7. After 3 minutes, is the oven cavity hot?
If you answer "NO" to any question first check that the oven is plugged in properly and the fuse has not blown. If there is no fault with either, check against the troubleshooting chart on the following page.

NOTES:

- Safety powerdowns:
If you cook food for more than the standard time (see chart opposite) using the same cooking mode, the oven's safety mechanisms automatically activate. The microwave power level will be reduced or the grill heating elements will turn on and off.
- After manual or automatic cooking using the Grill, Combi or Convection modes, the cooling fan will switch on to cool the oven cavity. When the cooling fan works, the display may show "NOW COOLING". To clear it, press the **STOP/CLEAR** key and the display will return to the time of day, if set. During these modes, the cooling fan will carry on working after you have pressed the **STOP/CLEAR** key. You may feel hot air blowing out of the air-vent openings.

⚠ WARNING:

Never adjust, repair or modify the oven yourself. It is hazardous for anyone other than a SHARP trained engineer to carry out servicing or repairs.

This is important as it may involve the removal of covers that provide protection against microwave energy.

- The door seal stops microwave leakage during oven operation, but does not form an airtight seal. It is normal to see drops of water, light or feel warm air around the oven door. Food with a high moisture content will release steam and cause condensation inside the door which may drip from the oven.
- Repairs and Modifications: Do not attempt to operate the oven if it is not working properly.
- Outer Cabinet & Lamp Access: Never remove the outer cabinet. This is very dangerous due to high voltage parts inside which must never be touched, as this could be fatal. Your oven is not fitted with a lamp access cover. If the lamp fails, do not attempt to replace the lamp yourself, call a SHARP approved service facility.

IMPORTANT:

If the display is blank and has gone dark, even if the power plug is properly connected, the oven may be in Energy Save Mode. To cancel it, open and then close the oven door, see page 8.

SAFETY POWERDOWNS

Cooking Mode	Standard Time
Microwave 100% cooking	20 Minutes
Grill-1	15 Minutes
Grill-2	15 Minutes
Grill-3	Top Grill 6 Minutes Btm Grill 6 Minutes
Combi-2	
Microwave 100%	Microwave 20 Minutes Top Grill 15 Minutes
Microwave 10 - 70%	Top Grill 15 Minutes
Combi-3	
Microwave 100%	Microwave 20 Minutes Btm Grill 15 Minutes
Microwave 10 - 70%	Btm Grill 15 Minutes



TROUBLESHOOTING

QUERY	ANSWER
Draught circulates around the door.	When the oven is working, air circulates within the cavity. The door does not form an airtight seal so air may escape from the door.
Condensation forms in the oven, and may drip from the door.	The oven cavity will normally be colder than the food being cooked, and so steam produced when cooking will condense on the colder surface. The amount of steam produced depends on the water content of the food being cooked. Some foods, such as potatoes have a high moisture content. Condensation trapped in the door glass should clear after a few hours.
Flashing or arcing from within the cavity when cooking.	Arcing will occur when a metallic object comes into close proximity to the oven cavity during cooking. This may possibly roughen the surface of the cavity, but would not otherwise damage the oven.
Arcing potatoes.	Ensure all "eyes" are removed from the potatoes and that they have been pierced, place directly onto the turntable or in a heat resistant flan dish or similar.
The display is lit but the control panel will not work when pressed.	Check the door is closed properly.
Oven cooks too slowly.	Ensure correct power level has been selected.
Oven makes a noise.	The microwave energy pulses ON and OFF during cooking/defrosting.
Outer cabinet is hot.	The cabinet may become warm to the touch - keep children away.
The display shows message for "DEMO MODE", or the time in the display is counting down very rapidly.	Your oven may be set in Demo Mode. To cancel Demo Mode, unplug the oven from the socket and replug.



TO REPLACE THE MAINS PLUG

The wires in the mains cable are colour coded as shown:

Green and yellow stripes = **EARTH**
Blue = **NEUTRAL**
Brown = **LIVE**

As the colours in the mains lead of your oven may not correspond with the coloured marking identifying the terminals in your plug, connect the wires as described:

- The green and yellow wire to the plug terminal marked E **or**  **or** coloured green **or** coloured green and yellow.
- The blue wire to the plug terminal marked N **or** coloured black **or** coloured blue.
- The brown wire to the plug terminal marked L **or** coloured red **or** coloured brown.

Make sure the terminal screws are tight and the cable is held securely by the cable grip where it enters the plug.

Like most appliances in your home, your oven must be connected to a single phase 230-240V, 50Hz alternating current supply.

If you do not make the proper electrical connections you might damage the oven or injure yourself. Neither SHARP nor the supplier will be liable if this happens.



WARNING: THIS APPLIANCE MUST BE EARTHED

If you have any doubts about your electrical supply ask a qualified electrician.

CALLING FOR SERVICE

- If you are unable to resolve a problem using the checks covered on the last few pages, **do not attempt to service this microwave oven yourself.**
- Contact the dealer or supplier from whom the oven was purchased in order to obtain service. Where this is not possible, please contact the SHARP Customer Information Centre.
Telephone: 08705 274277 (office hours).

- For general information and assistance with oven queries, please contact our **Customer Information Centre:**
U.K.: 08705 274277 (office hours)
Ireland: 01 676 0648 (office hours)
Website: www.sharp.co.uk/customersupport
- Replacement accessories may be obtained from our main parts distributor:
Willow Vale Electronics Ltd.
Telephone: 0121 766 5414



COOKBOOK

CONTENTS

INTRODUCTION & CONVERSION CHARTS	41
DEFROSTING CHART:	
Meat, Poultry, Fish and Fruit	42
COOKING CHART	
Fish, Fresh & Frozen Vegetables and Fruit	43
Brown Rice and Eggs	44
GRILLING CHART	45
COMBI - 1 COOKING CHART	46
COMBI - 2 COOKING CHART	47
REHEATING CHART	48
RECIPES	49 - 67

INTRODUCTION

This Cookbook contains a wide variety of recipes developed specifically for this product. These will give you successful results and will save time and electricity. The recipes demonstrate the capabilities of your oven and prove that microwave technology is the efficient and effective alternative to conventional cooking.

COOKERY NOTES

- Weigh all meat and poultry prior to defrosting and cooking, as labelled weights are only approximate.
- Where dishes are covered use vented microwave cling film unless otherwise stated. Where dishes are lined, use greaseproof paper unless otherwise stated.
- Note that all preparation times and serving quantities are approximate.
- All ingredients are given in both metric and imperial measures. Use either set but not a combination of both measures.
- Cooking results will vary according to the condition of foods, utensils and the oven. Please check the cooking result and, if necessary, adjust cooking times accordingly.
- Serve all dishes immediately unless otherwise stated.
- Butter and margarine can be interchanged as preferred.
- Half-fat, skimmed or full-fat milk may be used as preferred.
- Where it is necessary to blend foods, use a food processor, liquidiser or press through a sieve.
- Chilled foods are to be cooked from 5°C.
- Ambient/fresh/dried/canned foods are to be cooked from 20°C.
- Frozen foods are to be cooked from -18°C.

CONVERSION CHARTS

WEIGHT MEASURES		VOLUME MEASURES		SPOON MEASURES	
15g	1/2oz	30ml	1floz	1.25ml	1/4 teaspoon
25g	1oz	100ml	3floz	2.5ml	1/2 teaspoon
50g	2oz	150ml	5floz (1/4 pint)	5ml	1 teaspoon
100g	4oz	300ml	10floz (1/2 pint)	15ml	1 tablespoon
175g	6oz	600ml	20floz (1 pint)		
225g	8oz				
450g	1lb				



DEFROSTING CHART

FOOD	DEFROST TIME	COOKING MODE	METHOD	STANDING TIME
Minced Meat	5 Min. 30 Secs/ 500g	30%	Place in a flan dish on the turntable. Turn over 3 times and remove any defrosted meat.	15 - 30 Minutes
Liver	10 Min. 40 Secs/ 500g	30%	Place in a flan dish on the turntable. Turn over 3 times and remove any defrosted meat.	15 - 30 Minutes
Steak and Chops	12 Minutes/ 450g	10%	Place in a flan dish. Turn twice, separate during defrosting. Shield.	15 - 30 Minutes
Sausages	7 Min. 30 Secs/ 450g	10%	Place in a flan dish. Turn twice, separate during defrosting. Shield.	15 - 30 Minutes
Bacon	7 Min. 30 Secs/ 250g	10%	As sausage above.	15 - 30 Minutes
Chicken Legs	8 Minutes/ 450g	Stage1:30% Stage2:10%	Calculate the cooking time and divide into 4. Cook on 30% for first stage then 10% for remaining time. Turn 3 times, separate during defrosting. Shield.	25 - 30 Minutes
Chicken (Breasts)	10 Minutes/ 450g	10%	Place in a flan dish. Turn 3 times, separate during defrosting. Shield.	25 - 30 Minutes
Whole Fish, fillets and steaks	7 Minutes/ 450g	10%	Place in a flan dish. Separate and re-arrange twice during defrosting. Shield.	15 - 30 Minutes
Apple/ Blackcurrants/ Redcurrants/ Raspberries/ Blackberries/ Gooseberries/ Rhubarb/ Strawberries	7 Min. 30 Secs/ 500g	10%	Place in a dish. Stir twice during defrosting. Shield.	15 - 20 Minutes
Bread (sliced)	6 Minutes/ 400g	10%	Place on the turntable. Separate and rearrange during defrosting.	5 - 10 Minutes
Pastry (Puff or Shortcrust)	8 Minutes/ 500g	10%	Place on a plate. Turn over half way through defrosting.	10 - 15 Minutes
Meat & Fruit Pies (cooked)	4 Min. 30 Secs/ 450g	30%	Remove from foil container. Place in a flan dish.	15 - 20 Minutes

NOTES:

- Do not use the racks for defrosting.
- If shielding is necessary, use small pieces of foil.
- During recommended standing time, wrap or cover food in foil.





MICROWAVE COOKING CHART

FOOD	COOKING TIME	COOKING MODE	METHOD	STANDING TIME
Fish Fillets/Steaks	3 Minutes/150g 4 Min. 30 Secs. /450g	100%	Place in a single layer in a flan dish. Cover and cook.	2 Minutes
Whole Fish	6 Minutes/ 450g	100%	Place in a single layer in a flan dish. Cover and cook.	2 Minutes
Aubergine, Broccoli, Cauliflower, Courgettes, Leeks, Cabbage, Celery, Spinach, Parsnips, Green Beans, Peas (fresh)	5 Minutes/ 225g	100%	Slice. Add 30ml (2 tbsp) water. Cover dish. Stir halfway through cooking.	2 Minutes
Corn on the cob, Carrots, Sprouts (fresh)	6 Minutes/ 225g	100%	Add 45ml (3 tbsp) water. Cover. Stir halfway through cooking.	2 Minutes
Turnip & Swede (fresh)	8 Minutes/ 225g	100%	Dice. Add 45ml (3 tbsp) water. Cover dish. Stir halfway through cooking.	2 Minutes
Jacket Potatoes (250g/9oz - each) (fresh)	10 Minutes/ 2 potatoes	100%	Pierce in several places. Place on the edge of the turntable. Turn over halfway through cooking.	5 Minutes
Boiled Potatoes (old & new - fresh)	10 Minutes/ 450g	100%	Cut into quarters. Add 60ml (4 tbsp) water. Cover. Stir halfway through cooking.	5 Minutes
Mixed vegetables, Carrots, Cauliflower, Broccoli, Beans, Cabbage (frozen)	8 Minutes/ 225g	100%	Place in dish. Add 15ml (1 tbsp) water. Cover dish. Stir halfway through cooking.	2 Minutes
Corn on the Cob (frozen)	6 Minutes/ 225g	100%	Place in dish. Cover dish. Turnover halfway through cooking.	2 Minutes
Apples & Rhubarb (fresh)	7 Minutes/ 450g	100%	Peel & slice. Place in a dish and cover. Stir halfway through cooking.	2 Minutes
Blackberries/Raspberries/Redcurrants (fresh)	5 Minutes/ 450g	100%	Place in a dish and cover. Stir halfway through cooking.	2 Minutes

NOTES:

- Fresh vegetables and fresh fruit are cooked from 20°C.
- Frozen vegetables are cooked from -18°C.



MICROWAVE COOKING CHART

FOOD	COOKING TIME	COOKING MODE	METHOD	STANDING TIME
Brown Rice	22 Minutes	70%	Add 400ml (14fl.oz) boiling water/100g rice. Do not cover. Stir twice during cooking. Rinse, and serve.	2 Minutes
Scrambled Eggs	15g butter 2 eggs (medium) 30ml (2 tbsp) milk salt & pepper	70%	1 Melt the butter in a bowl on 70% for 30 seconds. 2 Add the eggs, milk and seasoning and mix well. 3 Cook on 70% for 2 minutes. Stir halfway through cooking.	30 Seconds
Omlette	15g butter 4 eggs (medium) 90ml (6 tbsp) milk salt & pepper	100%	1 Whisk together eggs and milk. Season. 2 Place butter in a 25cm flan dish. Heat on 100% for 1 minute, until melted. Coat the dish with the melted butter. 3 Pour omelette mixture into flan dish. Cook on 100% for 1 minute. Whisk mixture and cook again on 100% for 4 minutes.	30 Seconds

NOTE:

- Eggs are cooked from 5°C.



GRILL - 3 COOKING CHART (TOP & BOTTOM GRILLS)

FOOD	COOKING TIME	COOKING MODE	METHOD
Tea Cakes	5 Minutes/ 2 teacakes	GRILL - 3	Slice in half. Place directly onto the turntable. Turn over after 3 Minutes.
Muffins	6 Minutes/ 2 muffins	GRILL - 3	Slice in half. Place directly onto the turntable. Turn over halfway through cooking.
Crumpets	6 Minutes/ 4 crumpets	GRILL - 3	Place bottom side up onto the turntable.
Cheese on Toast	6 Minutes/ 2 slices	GRILL - 3	Cover each slice with 50g of grated cheese. Place bread directly onto the turntable.
Oven Chips (thick cut)	9 Minutes/200g 18 Minutes/400g	GRILL - 3	Place directly onto the turntable. 200 g: Turn over after 5 Minutes 400 g: Turn over after 9 Minutes
Bacon	12 Minutes/ 8 slices	GRILL - 3	Place directly onto the turntable. Turn over halfway through cooking.
Gammon Steak	12 Minutes/225g	GRILL - 3	Place directly onto the turntable. Turn over halfway through cooking.
Sausages	10 Minutes/ 8 thin or 4 thick 12 Minutes/ 12 thin or 8 thick	GRILL - 3	Pierce skin, place directly onto the turntable. Turn over four times during cooking.
Beefburgers (chilled)	12 Minutes/ 4 quarter pounders	GRILL - 3	Place directly onto the turntable. Turn over halfway through cooking.
Beefburgers (frozen)	14 Minutes/ 4 quarter pounders	GRILL - 3	Place directly onto the turntable. Turn over halfway through cooking.
Fish Fingers (frozen)	10 Minutes/ 12 pieces	GRILL - 3	Place directly onto the turntable. Turn over after 6 Minutes.
Toasted Sandwich	5 Minutes/ 2 sandwiches	Stage 1: GRILL - 3 Stage 2: COMBI - 3, 30%	Prepare sandwich: Place two slices of ham and 50g grated cheese between 4 slices of bread and butter. Place sandwiches directly onto the turntable. Use Sequence cooking. (Page 28.) Stage 1: Cook on GRILL - 3, for 4 Minutes. Turn over. Stage 2: Cook on COMBI - 3, 30% for 1 Minute.

NOTES:

- Chilled foods are cooked from 5°C.
- Frozen foods are cooked from -18°C.
- No standing time is required for the foods in this chart.



COMBI -1 COOKING CHART (CONVECTION & MICROWAVE)

FOOD	COOKING TIME	COOKING MODE	METHOD
Beef (rare) (chilled)	13 Minutes/ 450g	COMBI - 1 160°C, 50%	Place on the low rack. Calculate cooking time.
Fish (Fillets, Steaks, whole) (chilled)	15 Minutes/ 450g	COMBI - 1 220°C, 30%	Place in a flan dish on the low rack. Stand for 2 minutes after cooking.
Sausage Rolls (uncooked, frozen)	20 Minutes/ 6 sausage rolls (approx. 50g each)	Preheat 200°C COMBI - 1 200°C, 10%	Preheat oven to 200°C. Glaze and place in a flan dish on the low rack. Stand for 2 minutes after cooking.
Garlic Bread (chilled)	5 Minutes/ 1 baguette	Preheat 250°C COMBI - 1 250°C, 10%	Preheat oven to 250°C. Remove any packaging. Place in a flan dish on the low rack. No standing time is required.
Garlic Bread (frozen)	8 Minutes/ 1 baguette	Preheat 250°C COMBI - 1 250°C, 10%	Preheat oven to 250°C. Remove any packaging. Place in a flan dish on the low rack. No standing time is required.
Baked Potatoes	20 Minutes/ 2 potatoes (250g each)	Preheat 250°C COMBI - 1 250°C, 10%	Preheat oven to 250°C. Pierce each potato in several places. Place in a flan dish on the low rack. No standing time is required.
Roast Potatoes	35 Minutes/ 600g potatoes	Preheat 250°C COMBI - 1 220°C, 30%	Preheat oven to 250°C. Cut into even sized pieces. Brush with oil. Place in a flan dish on the low rack. Turn over four times during cooking. No standing time is required.

NOTES:

- Chilled foods are cooked from 5°C.
- Frozen foods are cooked from -18°C.



COMBI - 2 COOKING CHART (TOP GRILL & MICROWAVE)

FOOD	COOKING TIME	COOKING MODE	METHOD
Chicken Fillets (with skin) (chilled)	10 Minutes/ 450g	Stage 1: 70% Stage 2: COMBI - 2, 70%	Place skin side down in a flan dish on the low rack. Calculate the cooking time. Use Sequence cooking. (Page 28.) Stage 1: Cook on 70% for 5 Minutes. Turn over, remove juices. Stage 2: Cook on COMBI - 2, 70% for 5 Minutes. Stand for 2 minutes after cooking.
Chicken Legs (chilled)	13 Minutes/ 450g	As above	Place skin side down in a flan dish on the low rack. Calculate the cooking time. Use Sequence cooking. (Page 28.) Stage 1: Cook on 70% for 5 Minutes. Turn over, remove juices. Stage 2: Cook on COMBI - 2, 70% for 8 Minutes. Stand for 2 minutes after cooking.
Chicken Breasts (chilled)	14 Minutes/ 450g	As above	Place skin side down in a flan dish on the low rack. Calculate the cooking time. Use Sequence cooking. (Page 28.) Stage 1: Cook on 70% for 6 Minutes. Turn over. Stage 2: Cook on COMBI - 2, 70% for 8 Minutes. Stand for 2 minutes after cooking.
Lamb Chops (chilled)	9 Minutes/ 450g	Stage 1: COMBI - 2, 70% Stage 2: GRILL - 1	Place in a flan dish on the low rack. Calculate the cooking time. Use Sequence cooking. (Page 28.) Stage 1: Cook on COMBI - 2, 70%. Turn over, remove juices. Stage 2: Cook on GRILL - 1 for 4 Minutes.
Pork Chops (chilled)	14 Minutes/ 450g	Stage 1: COMBI - 2, 70% Stage 2: GRILL - 1	Place in a flan dish on the low rack. Calculate the cooking time. Use Sequence cooking. (Page 28.) Stage 1: Cook on COMBI - 2, 70%. Turn over, remove juices. Stage 2: Cook on GRILL - 1 for 6 Minutes.

NOTES:

- Chilled foods are cooked from 5°C.
- Frozen foods are cooked from -18°C.





REHEATING CHART

FOOD	COOKING TIME	COOKING MODE	METHOD
Canned foods	5 Minutes/ 425g	70%	Remove from the can. Place bowl on turntable. Stir halfway through cooking. Stand for 2 minutes after cooking.
Christmas pudding	1 Min 30 Secs/ 125g	100%	Place in a flan dish on turntable. Do not exceed cooking time advised by food manufacturer. Stand for 30 seconds after cooking.
	2 Minutes/175g	100%	As above
	4 Minutes/450g	70%	Place in a flan dish on turntable. Do not exceed cooking time advised by food manufacturer. Stand for 1 minute after cooking.
Sausage rolls (cooked, chilled approx. 50g (2oz) each)	8 Minutes/ 6 sausage rolls	COMBI - 1 230°C, 10%	Place in a flan dish on the low rack. Stand for 2 minutes after cooking.
Quiche, (cooked, chilled)	8 Minutes/ 175g 14 Minutes/ 400g	COMBI - 1 230°C, 10%	Remove foil container. Place in a flan dish on the low rack. Stand for 2 minutes after cooking.
Meat Pie (cooked, chilled)	8 Minutes/150g 11 Minutes/250g 18 Minutes/600g	COMBI - 1 230°C, 10%	Remove foil container. Place in a flan dish on the low rack. Stand for 2 minutes after cooking.
Fruit Pie (cooked, chilled)	40 Seconds/70g	50%	Remove foil container. Place in a flan dish on the turntable. Stand for 1 minute after cooking.
	10 Minutes/450g 15 Minutes/700g	COMBI - 1 230°C, 10%	Remove foil container. Place in a flan dish on the low rack. Stand for 2 minutes after cooking.
Bread rolls/ Croissants	30 Seconds/2	70%	Place on the turntable.
Garlic bread (cooked, chilled)	3 Minutes/ 1 baguette	100%	Place on the turntable, uncovered.
Pizza (cooked, chilled)	45 Seconds/ 125g 3 Minutes/ 400g 4 Minutes/ 500g	100%	Place on a plate, uncovered. Stand for 2 minutes after cooking.

NOTES:

- Take care when heating foods with high sugar or fat content, for example, Christmas pudding and mince pies.
- DO NOT EXCEED THE REHEATING TIMES GIVEN IN THE CHART ABOVE.





RECIPES

Serves 4

50g onion, sliced
50g celery, chopped
50g green pepper, sliced
50g red pepper, sliced
50g sun-dried tomatoes, chopped
50g sweetcorn
250g beef fillet, sliced into thin strips
200g Arborio Risotto Rice
1 tsp lemon juice
3 tbsps sweet chilli sauce
(600ml) 1 pint hot beef stock
salt and pepper

BEEF RISOTTO

- 1 Mix together all of the ingredients into a 2.5 litre (approx. 4 pint) casserole dish.
- 2 **Do not cover.**
- 3 Place on the turntable.
- 4 Stir when the audible signal sounds.
- 5 After cooking, stir and leave to stand for 5 minutes.

Serves 4

50g onion, sliced
50g mushroom, chopped
50g green pepper, sliced
50g red pepper, sliced
50g sweetcorn
250g turkey breast, sliced into thin strips
200g Arborio Risotto Rice
1 tsp lemon juice
1 tsp cayenne pepper
1/2 tsp cumin
2/3 pint hot chicken stock
pinch of saffron
salt and pepper
50g pecorino cheese, grated

SPICY TURKEY RISOTTO

- 1 Mix together all of the ingredients (except the pecorino) into a 2.5 litre (approx. 4 pint) casserole dish and mix well.
- 2 **Do not cover.**
- 3 Place on the turntable.
- 4 Stir when the audible signal sounds.
- 5 After cooking, stir in the pecorino and leave to stand for 5 minutes.

Serves 4

200g Arborio Risotto Rice
400ml Hot Vegetable Stock
30g Butter
40g Spring Onion, sliced
80g Button Mushrooms, halved
75g Yellow Pepper, sliced,
75g Red Pepper, sliced
100g Frozen Peas,
100g Babycorn, chopped
175g Sweet Potatoes, diced
Handful of Flat Leaf Parsley, chopped
40g Parmesan Cheese, grated
Black Pepper to season
2 garlic cloves, crushed

VEGETABLE RISOTTO

- 1 Mix together all of the ingredients (except the Parmesan) into a 2.5 litres (approx. 4 pint) casserole dish and mix well.
- 2 **Do not cover.**
- 3 Place on the turntable.
- 4 Stir when the audible signal sounds.
- 5 After cooking, stir in the Parmesan and leave to stand for 5 minutes.



RECIPES

Serves 4 - 6

75g Celery, sliced
125g carrots, chopped
2 cloves of garlic, crushed
125g canned chick peas
125g canned black eyed beans
125g canned kidney beans
100g canned sweetcorn
400g canned chopped tomatoes
600ml (1 pint) hot vegetable stock
15ml (1tbsp) cornflour mixed with 1 tbs water

VEGETABLE & BEAN SOUP

- 1 Place the celery, carrots, garlic and leeks in a 2.5 litre casserole dish. Cook on 100% for 5 minutes.
- 2 Place the remaining ingredients into the bowl and mix well.
- 3 Cook on 50% for 40 minutes, stir 3 times during cooking.

Serves 4

5ml (1tsp) sunflower oil
200g onion, chopped
400g broccoli
25g plain flour
600ml (1 pint) hot vegetable stock
300ml (1/2 pint) milk
200g stilton
salt and pepper to taste

BROCCOLI & STILTON SOUP

- 1 Place oil, onion and broccoli in a large bowl, mix well. Cover and cook on 100% for 5 minutes.
- 2 Stir in the flour to form a paste, add the stock, milk and cheese, mix well. Cover and cook on 70% for 10 minutes.
- 3 Blend in a food processor. Return to bowl and season. Cook on 70% for 10 minutes.

Serves 4

4 Large open cap mushrooms
50g butter
75g cheddar cheese, grated

CRISPY STUFFED MUSHROOMS

- 1 Remove stalks and chop mushroom stalks.
- 2 Heat the butter and garlic on 100% for 1 minute.
- 3 Stir in the chopped mushroom stalks, and breadcrumbs. Fill the mushrooms with the mixture, and sprinkle with cheese.
- 4 Place in the flan dish on the turntable and cook on GRILL - 3 (TOP & BOTTOM GRILL) for 10 minutes.



RECIPES

Serves 4

200g white long grain rice
600ml (1 pint) chicken stock
200g red pepper, seeded, sliced
150g onion, chopped
200g chicken breast, cubed
100g Chorizo, diced
2 cloves garlic, peeled, crushed
10ml (2 tsp) of paprika
5ml (1 tsp) turmeric
250g tomatoes, skinned and chopped
250g raw tiger prawns
100g peas

PAELLA

- 1 Place the rice in the bowl, add stock, paprika, turmeric.
- 2 Stir in the chicken, prawns, peas, onion, peppers, tomatoes, garlic, cayenne pepper. Cook on 70% for 40 minutes, stir 3 times during cooking.

Serves 4

4 salmon steaks (approx. 200g each)
45ml (3 tbsp) dry white wine
300ml (1/2 pint) mustard sauce (see page 66)
sprig of fresh rosemary to garnish

POACHED SALMON WITH MUSTARD SAUCE

- 1 Place the salmon steaks in a flan dish, pierce in several places and add the wine. Cover and cook on 70% for 12 minutes. Allow to stand whilst preparing the sauce.
- 2 Place salmon steaks in a serving dish, reheat on 70% for 2 minutes. Serve the sauce separately.

Serves 4

200g canned asparagus, chopped
350g salmon fillet, cooked, flaked
200g cream cheese and chives
salt and pepper to taste
15ml (1 tbsp) fresh dill, chopped
450g puff pastry
1 egg, to glaze

SALMON & CHEESE PARCELS

- 1 Drain asparagus, place in a bowl with the salmon, cream cheese, seasoning and dill, mix well.
- 2 Preheat the oven to Convection 200°C.
- 3 Divide pastry into four and roll out to 17cm squares.
- 4 Place equal amounts of mixture into the centre of each square. Brush edges with egg. Form parcels by folding the corners over the filling. Pinch edges to form a raised edge. Brush with egg. Place in two large, greased flan dishes.
- 5 Place one dish on the low rack, the other on the high rack. Cook on Convection 200°C for 21 minutes. Swap the trays over and cook for a further 21 minutes until golden.

Serves 4

300g king prawns
50g butter
3 gloves garlic, crushed
5ml (1 tsp) fresh parsley

GARLIC PRAWNS

- 1 Place the butter and garlic into a bowl and cook on 100% for 1 minute.
- 2 Stir in the prawns and cook on 50% for 5 minutes, stirring every minute. Sprinkle with parsley to serve.

Serve in ramekin dishes with French bread.





RECIPES

Serves 4

900g potatoes, peeled and chopped
135ml (9 tbsp) water
25g margarine
30 - 60ml (2 - 4 tbsp) milk
salt and pepper to taste
600g fish fillets (e.g. fresh cod)
300ml (1/2 pint) white sauce (see page 66)
10ml (2 tsp) fresh dill

FISH PIE

- 1 Place the potatoes in a bowl and add the water. Cover and cook on 100% for 15 minutes. Mash with margarine, milk and seasoning.
- 2 Place fish in a flan dish in a single layer, cover and cook on 70% for 7 minutes. Flake the fish and mix into the sauce. Add the dill and mix well.
- 3 Pour into a 2.5l casserole dish, spread the potato on top.
- 4 Cook using sequence programming on 50% for 15 minutes then on COMBI - 2 (MICROWAVE & TOP GRILL), 50% for 10 minutes, until golden brown.

Serves 4

10ml (2 tsp) fresh green peppercorns, crushed
15ml (1 tbsp) fresh tarragon
2.5ml (1/2 tsp) salt
4 tuna steaks (150g/1 piece)
juice and grated rind of 2 oranges
30ml (2 tbsp) olive oil
15ml (1 tbsp) cornflour mixed with 2 tbsp water

GRILLED TUNA STEAK WITH ORANGE

- 1 Mix together peppercorns, tarragon and salt. Rub evenly onto the steaks and arrange in a flan dish, add orange juice and rind. Sprinkle generously with oil. Marinade in fridge for 2 - 3 hours.
- 2 Remove fish from the marinade and place in a flan dish.
- 3 Place on the turntable on COMBI - 2 (MICROWAVE & TOP GRILL), 50% for 7 minutes.
- 4 After cooking, stir in the cornflour and cook on 100% for a further 2 minutes.

Serve with new potatoes and fresh vegetables.



RECIPES

Serves 6

225g carrots, diced
150g celery, sliced
175g onion, finely chopped
600g pork, cubed
400g chopped tomatoes, canned
400g canned apricot halves, drained
2 cloves garlic, crushed (see tip below) juice and rind of half a lemon
15ml (1 tbsp) cornflour mixed with 30ml (2 tbsp) water
30ml (2 tbsp) dried mixed herbs

CITRUS PORK CASSEROLE

- 1 Place all ingredients into a 2.5 litre casserole dish and cook on COMBI - 1 (CONVECTION & MICROWAVE), 180°C, 50 % for 30 minutes, stir twice during cooking.
- 2 Stir the cornflour mixture into the casserole and cook on COMBI - 1, 180°C, 50% for 5 minutes.

Microwave Tip: Peeling garlic easily

Place 3 - 4 cloves of garlic on the turntable. Heat on 100% for 30 seconds, squeeze at one end until the clove pops out.

Serves 4

30ml (2 tbsp) vegetable oil
150g onion, finely chopped
100g celery, finely chopped
2 cloves garlic, crushed
75g smoked streaky bacon, chopped
2 bay leaves
400g canned, chopped tomatoes
30ml (2 tbsp) tomato purée
500g lean minced beef
150ml (1/4 pint) red wine
150ml (1/4 pint) hot beef stock
30ml (2 tbsp) cornflour blended with 30ml (2 tbsp) water
salt and pepper to taste

BOLOGNESE SAUCE

- 1 Place oil, onion, celery, garlic and bacon into a 2.5 litre (approx. 4 pint) dish, mix well.
- 2 Cook on 100% for 5 minutes.
- 3 Add all the remaining ingredients, mix thoroughly.
- 4 Cook on 70% for 25 minutes, stir twice during cooking.

Serve hot with spaghetti.

chilli con carne: Make as above.
At Stage 3 add 450g canned red kidney beans and 5 - 15ml (1 - 3 tsp) chilli powder, to taste.

Serves 4

225g lean minced beef
2 cloves garlic, crushed (see tip above)
75g onion, chopped
2 fresh green chills, chopped
225g canned, chopped tomatoes
100g canned, red kidney beans
2.5ml (1/2 tsp) cumin powder
30ml (2 tbsp) tomato puree
8 taco shells, pre-cooked
175g Cheddar cheese, grated

MEXICAN TACOS

- 1 Place the mince, garlic, onion, chillies, tomato puree, tomatoes, kidney beans and cumin into a 2.5l casserole dish, mix well. Cook on 100% for 16 minutes, stir twice during cooking.
- 2 Fill the tacos with the chilli, and sprinkle with cheese.
- 3 Place dish on the turntable and cook on COMBI - 2 (MICROWAVE & TOP GRILL), 30% for 6 minutes.





RECIPES

Serves 4

450g braising steak
175g mushrooms
15ml (1 tbsp) mixed herbs
300ml (1/2 pint) beef stock
15ml (1 tbsp) tomato puree
15ml (1 tbsp) cornflour
15ml (1 tbsp) water

STEAK & MUSHROOM PUDDING

- 1 Place steak, onion, mixed herbs and stock in a casserole dish. Cover and cook on 70% for 30 minutes. Stir three times during cooking and add the cornflour to thicken.
- 2 To make the pastry, place the flour, salt, baking powder and suet in a bowl, mix well.
- 3 Add enough cold water to form a soft dough. Roll out $\frac{2}{3}$ of the pastry and use it to line the base and sides of a greased 1.2 litre (2 pint) pudding basin.
- 4 Fill pastry lined basin with meat leaving room for the lid. Roll out remaining pastry, cut out a circle to cover pudding. Brush with milk. Make a slit in the centre. Cover with cling film, pierce and cook on 70% for 8 minutes.

Serves 4

30g plain flour
salt & pepper to taste
500g braising steak, diced
25g margarine
100g smoked streaky bacon, chopped
200g carrot, sliced
75g peas
150g mushrooms, halved
100g onion, chopped
300g potatoes, cubed
15ml (1 tbsp) Worcester sauce
300ml (1/2 pint) hot beef stock
150ml (1/4 pint) red wine
15ml (1 tbsp) cornflour blended with water

BEEF CASSEROLE

- 1 Mix together the flour, salt and pepper in a dish.
- 2 Toss the steak in the seasoned flour until well coated.
- 3 Put all of the remaining ingredients (except cornflour) into a 2.5l casserole dish, add the steak and stir well.
- 4 Cover with a lid and cook on COMBI-1, 50% for 30 minutes, stir twice, then stir in the cornflour and cook on 50% for a further 10 minutes.



RECIPES

Serves 4

MARINADE:

15ml (1 tbsp) groundnut oil
15ml (1 tbsp) lemon juice
75ml (5 tbsp) crunchy peanut butter
1 clove crushed garlic
1 red chilli, finely chopped and de-seeded
15ml (1 tbsp) tabasco sauce
600g chicken breast, flattened & cut into strips
200ml coconut milk
4 wooden skewers (see tip, page 58)

CHICKEN SATAY

- 1 Place all the marinade ingredients in a large bowl, mix well. Stir in the chicken, refrigerate for 2 hours to marinate.
- 2 Thread the chicken onto skewers leaving no wood exposed. Place in a large flan dish on the high rack. Cook on COMBI - 2 (MICROWAVE & TOP GRILL), 70% for 15 minutes. Turn over skewers every 3 minutes.

Serves 4

4 large chicken breast fillets, skinned (approx. 150g each)
100g Feta, finely chopped
3 spring onions, finely chopped
2.5ml (1/2 tsp) dried parsley
salt and pepper to taste
cocktail sticks to secure
75g Cheddar cheese, grated

CHICKEN FETA ROLLS

- 1 Open out chicken breasts, flatten with a rolling pin.
- 2 Place Feta, onions, parsley and seasoning in a bowl, mix well. Place a quarter of the mixture at one end of each breast. Roll up tight and secure with cocktail sticks. Ensure no filling is visible.
- 3 Place the breasts seam side upwards in a flan dish.
- 4 Place on the low rack and cook on COMBI - 2 (MICROWAVE & TOP GRILL), 70% for 15 minutes, turn over and add cheese after 10 minutes.

Sprinkle with toasted almonds to serve.

Microwave Tip: Toasting Almonds

Place 25g (1 oz) almonds in a shallow flan dish with a knob of butter, heat on 100% for 3 minutes, stir every minute until golden.

Serves 6

10 freeze dried kaffir leaves, crushed
400ml coconut milk
3 tbsp green curry paste
600g cubed chicken
2cm chopped ginger
75g green beans
1 tbsp fish sauce
1 tbsp brown sugar
150g sliced courgette
150g mushrooms, halved
1 sliced red pepper
150g chopped onion
200ml cream

THAI GREEN CURRY

- 1 Place all of the ingredients except the cream into a 2.5l casserole dish, mix well and cover.
- 2 Place the dish on the low rack and cook on COMBI - 1 (CONVECTION & MICROWAVE), 180°C, 30% for 40 minutes. Stir 3 times during cooking.
- 3 After cooking, stir in the cream and serve.



RECIPES

Serves 4

4 chicken fillets (approx. 200g each)
75ml (6 tbsp) clear honey
30ml (2 tbsp) wholegrain mustard
2.5ml (1/2 tsp) dried tarragon
30ml (2 tbsp) tomato puree
150ml (1/4 pint) chicken stock
15ml (1 tbsp) cornflour blended with water
salt and pepper to taste

HONEYED CHICKEN

- 1 Mix all the ingredients, except the chicken, together in a 2.5 litre (approx. 4 pint) casserole dish.
- 2 Add the chicken and turn over to coat with the sauce.
- 3 Cook on 70% for 20 minutes, stir halfway through cooking.

Microwave Tip: Softening crystallised honey

Place 100g honey in a bowl. Heat on 100% for 1 minute until runny.

Microwave Tip: Softening cream cheese

Place 225g cream cheese on a plate. Heat on 30% for 1 minute until soft.

Serves 4

400g canned, chopped tomatoes
150g broccoli florets
50g onion, chopped
350g chicken fillet, diced
10ml (2 tsp) dried basil
15ml (1 tbsp) garlic purée
200g cooked pasta
300ml (1/2 pint) white sauce (see page 66)
100g mature cheddar cheese, grated

CHICKEN AND PASTA BAKE

- 1 Place the tomatoes, broccoli, onion, chicken fillet, basil and garlic puree into a 2.5l casserole dish and mix well. Cook on 70% for 15 minutes, stir once during cooking.
- 2 Spread the pasta over the mixture.
- 3 Pour the cheese sauce over the pasta and sprinkle with the grated cheese.
- 4 Place on the turntable and cook on COMBI - 2 (MICROWAVE & TOP GRILL), 70% for 15 minutes, stir once during cooking.



RECIPES

Serves 4 - 6

15ml (1tbsp) olive oil
175g onions
2 cloves garlic, crushed
75g tomato puree
200g carrots, chopped
1 red pepper, sliced
1 green pepper, sliced
50g sweetcorn
200g courgettes, sliced
5ml (1tsp) ground cumin
5ml (1tsp) chilli powder
400g canned tomatoes
400g canned kidney beans
300ml (1/2 pint) vegetable stock
15ml (1tbsp) cornflour mixed with water

VEGETABLE CHILLI

- 1 Place the oil, onion, garlic and tomato puree in a large bowl. Heat on 100% for 2 minutes.
- 2 Add the carrots, red and green pepper and sweetcorn, mix well. Cover and cook on 100% for 3 minutes.
- 3 Stir in the remaining ingredients (apart from the cornflour). Mix well and cook on 70% for 20 minutes, stir twice during cooking.
- 4 Add the blended cornflour, mix well and cook on 70% for 10 minutes.

Serve hot with rice or as a filling for tacos.

Microwave Tip: Heating taco shells

Place 8 - 10 pre-cooked crisp taco shells on kitchen paper on the turntable. Heat on 100% for 1 1/2 - 2 minutes until warm. Spoon in filling as preferred.

Serves 4 - 6

15ml (1 tsp) olive oil
150g onion, chopped
2 cloves garlic, crushed
175g leeks, sliced
100g mushrooms, thickly sliced
10ml (2 tsp) chopped fresh basil
10ml (2 tsp) chopped fresh oregano
225g red split lentils
45ml (3 tbsps) tomato puree
400g canned chopped tomatoes
300ml (1/2 pint) hot vegetable stock
1 bay leaf
salt and pepper to taste
12 sheets lasagne (spinach)
600ml (1 pint) cheese sauce (see page 66)
50g Cheddar cheese, grated

RED LENTIL LASAGNE

- 1 Place oil, onion and garlic in a bowl, cook on 100% for 2 minutes.
- 2 Add the leeks, mushrooms, basil, oregano, lentils and cook on 100% for 5 minutes.
- 3 Stir in the tomato puree, tomatoes, stock and the bay leaf.
- 4 Cover and cook on 70% for 20 minutes.
- 5 Season with salt and pepper then remove the bay leaf.
- 6 Make the cheese sauce.
- 7 Put a layer of the lentil mixture into the base of a deep, 25cm square dish. Cover with some lasagne and then some of the cheese sauce. Repeat, making the last layer cheese sauce, add the grated cheese.
- 8 Place on low rack and cook on COMBI - 1 (CONVECTION & MICROWAVE), 220°C, 30% for 30 minutes.



RECIPES

Serves 2

2 baking potatoes, (approx. 250g each)
100g double Gloucester cheese, finely chopped
100g cooked ham, chopped
75g mushrooms, finely chopped
salt and pepper to taste
45ml (3 tbs) double cream

CHEESY JACKET POTATOES

- 1 Prick each potato in several places. Place on turntable and cook on COMBI - 1 (MICRO & CONVECTION), 250°C, 50% for 20 minutes.
- 2 Halve each potato and scoop out the flesh into a bowl, add the cheese, ham, mushrooms and cream. Season and mix well.
- 3 Pile mixture back into the potato skins and place in a flan dish, on the low rack.
- 4 Cook on COMBI - 2 (MICRO & TOP GRILL), 50% for 10 minutes.

Cheese & sweetcorn jackets: Omit the Double Gloucester cheese, chives and mushrooms.
Add 100g of grated Cheddar cheese and 50g sweetcorn at stage 2.

Cook's Tip: Wooden Skewers

To remove food easily from wooden skewers, soak the skewers in water for 30 minutes prior to using them.

Serves 4

600g canned, chopped tomatoes
150g red pesto
300g sun-dried tomatoes, drained and chopped
salt and pepper to taste
600g fresh ravioli (meat or vegetarian)
600ml (1 pint) cheese sauce (see page 66)
100g grated cheddar cheese

TOMATO AND PASTA LAYER

- 1 Empty the tomatoes into a large bowl and cook on 100% for 8 minutes to reduce the juice.
- 2 Combine the chopped tomatoes, pesto and sun-dried tomatoes and season well.
- 3 Spread a 1/2 of this sauce over the base of a greased 25cm square dish, then place a single layer of ravioli over the tomatoes. Repeat and finish with a layer of cheese sauce.
- 4 Sprinkle the grated cheese over the top and place the dish on the low rack. Cook on COMBI - 1 (CONVECTION & MICROWAVE), 220°C, 30% for 20 minutes.

Serves 4 - 6

300g short crust pastry
6 rashers of bacon, chopped
125g onion, finely chopped
4 eggs (medium)
300ml (1/2 pint) milk
salt and pepper to taste
5ml (1 tsp) dried mixed herbs (see tip, page 60)
225g Cheddar cheese, grated

QUICHE LORRAINE

- 1 Preheat the oven to 200°C.
- 2 Line a 25cm flan dish with pastry, place on the low rack and cook on 200°C for 10 minutes.
- 3 Place bacon and onion in a bowl, cook on 100% for 3 minutes.
- 4 Place eggs, milk, seasoning in a bowl, mix well.
- 5 Spread bacon and onion evenly over the pastry. Pour egg mixture over, top with grated cheese.
- 6 Place on the low rack, and cook on COMBI - 1 (CONVECTION & MICROWAVE), 220°C, 30% for 25 minutes until set and brown.



RECIPES

Serves 4

1 aubergine, thickly sliced
cooking salt
3 x 30ml (2 tbsp) vegetable oil
1 red pepper, large chunks
1 yellow pepper, large chunks
3 courgettes, thickly sliced
125g onion, sliced
100g mushrooms, thickly sliced
200g canned tomatoes, drained
2 cloves garlic, crushed
350g pasta (bows, shells, or tubes), cooked
100g feta cheese, crumbled

ROASTED VEGETABLE PASTA

- 1 Grease the turntable with the oil, place aubergine & peppers on the turntable and season. Cook using GRILL - 3 for 15 minutes, turn over twice during cooking.
- 2 Place the onion, mushrooms, tomatoes and garlic into a 2.5 litre (approx. 4 pint) casserole dish, mix well and cook on 100% for 5 minutes, stirring once.
- 3 Add the peppers, courgettes, aubergine pasta and feta to the tomato mixture and cook on 100% for 5 minutes.

Serves 4

125g onion, chopped
2 cloves garlic, crushed
25g butter
450g lean minced beef
100g mushrooms, chopped
30ml (2 tbsp) tomato puree
400g canned chopped tomatoes
salt and pepper to taste
approx 16 tubes of cannelloni
600ml (1 pint) cheese sauce (see page 66)
extra grated cheese to sprinkle
5ml (1 tsp) dried mixed herbs

CANNELLONI

- 1 Place onion, garlic and butter in a bowl, heat on 100% for 2 minutes. Add the mince, cook on 100% for 7 minutes.
- 2 Add mushrooms, tomato puree to the tomatoes and season well. Cook on 70% for 15 minutes until thickened, stir every 5 minutes.
- 3 Fill the tubes with the meat mixture.
- 4 Pour the cheese sauce on top of the filled cannelloni. Sprinkle with the cheese and mixed herbs.
- 5 Place on low rack, cook on COMBI - 1 (CONVECTION & MICROWAVE), 220°C, 30% for 25 minutes until brown and crispy.

Serves 4

4 large beef tomatoes
100g brown rice
50g peas
50g feta, crumbled
15ml (1 tbsp) fresh basil, chopped
salt and pepper
10g pine nuts

STUFFED TOMATOES

- 1 Slice the top off each tomato and scoop out the flesh. Place the flesh into a bowl, stir in the rice, peas, feta, basil, salt and pepper.
- 2 Fill each tomato with the mixture and place in a flan dish.
- 3 Place the flan dish on the low rack and cook on COMBI - 2 (MICROWAVE & TOP GRILL), 70% for 3 minutes, then cook on COMBI - 2, 50% for 9 minutes until the tomatoes are tender and the cheese is brown and crispy.



RECIPES

Serves 4 - 6

300g carrots, diced
300g swede, diced
250g onion, sliced
250g celery, sliced
200g onion, sliced
900ml (1.5 pints) hot vegetable stock
300g cous cous

VEGETABLE COUS COUS

- 1 Place the carrots, swede, celery, onion and stock into a 3 litres (5 pints) casserole dish, mix well and cook on 70% for 20 minutes, stirring once.
- 2 Add the cous cous, mix well and cook on 70% for 10 minutes.

Serve hot as an accompaniment or cold as a salad.

Microwave Tip: Drying breadcrumbs

Spread 100g fresh breadcrumbs evenly over a large plate. Heat on 100% for 2 - 3 minutes, stir every minute until crispy.

Serves 4

75ml (5 tbsp) vegetable oil
5ml (1 tsp) paprika
20ml (4 tsp) Tabasco sauce
5ml (1 tsp) ground cumin
10ml (2 tsp) fennel seeds
2 garlic cloves, finely chopped
15ml (1 tbsp) ginger puree
1 tsp sugar
salt and pepper to taste
500g potato in skins, washed and cut into 3cm cubes

SPICY POTATOES

- 1 Place the oil, paprika, Tabasco sauce, cumin, fennel seeds, garlic, ginger and sugar into a bowl, season well and mix.
- 2 Add the potatoes and coat with the spices.
- 3 Arrange in a single layer in a 25cm (10") flan dish.
- 4 Place on the turntable and cook on COMBI - 2 (MICRO & TOP GRILL), 50% for 20 minutes, turn over twice during cooking.

Microwave Tip: Drying herbs

Place a handful of fresh herbs between two sheets of kitchen paper on the turntable. Heat on 70% for 3 minutes until dry. Ensure the herbs do not become too dry. Woody herbs will take a little longer.

Serves 4

15ml (1 tbsp) sunflower oil
1 clove garlic, crushed
2 medium carrots, cut into strips
150g fresh baby sweetcorn
100g button mushrooms, halved
50g beansprouts
100g mange-tout
1 red pepper, seeded and chopped
1 yellow pepper, seeded and chopped
1 green pepper, seeded, chopped
1 medium onion roughly chopped
100g canned water chestnuts, sliced
225g canned pineapple chunks
1 quantity of sweet and sour sauce (see page 66)

SWEET & SOUR VEGETABLES

- 1 Place the oil, garlic, carrots and sweetcorn in a large bowl and mix well. Cover and cook on 100% for 4 - 5 minutes.
- 2 Stir in the mushrooms, beansprouts, mange-tout, peppers, onion, chestnuts and pineapple.
- 3 Cover and cook on 100% for 12 minutes, halfway through cooking stir the vegetables and add the sweet and sour sauce.





RECIPES

Serves 6

PASTRY:

150g butter
350g plain flour
50g caster sugar
2 egg yolks (medium)
cold water to mix

FILLING:

1 kg cooking apples, peeled and sliced
100g demerara sugar
10ml (2 tsp) ground cinnamon (optional)
grated rind of 1 orange (optional)
1 egg (medium) mixed with a little milk to glaze demerara sugar

APPLE PIE

- 1 For pastry, rub butter into flour until mixture resembles breadcrumbs. Stir in sugar and bind with egg yolk. Add enough cold water to make a soft, but not sticky, dough. Chill whilst making the filling.
- 2 For filling, combine apple, sugar, cinnamon (optional) and orange rind (optional) in a large bowl. Cook on 100% for 9 minutes, stirring 3 times.
- 3 Line the base of a greased 20cm x 2.5cm pie dish with half the pastry. Cook the pastry base on 50% for 5 minutes. Spoon in apple mixture, roll out remaining pastry and cover.
- 4 Pinch pastry edges to seal and make a slit in the centre with a sharp knife. Brush with egg mixture to glaze and sprinkle generously with sugar.
- 5 Place on the low rack, cook on COMBI - 1 (CONVECTION & MICROWAVE), 220°C, 10% for 20 minutes, until golden brown.

Makes 675g

150g milk chocolate, broken into pieces
100g butter, melted
450g icing sugar, sieved
45ml (3 tbsp) milk

CHOCOLATE FUDGE

- 1 Place the chocolate in a bowl and heat on 100% for 2 minutes, stir every 30 seconds until melted.
- 2 Stir in butter, icing sugar and milk. Heat on 100% for 4 minutes, stir vigorously every minute until the mixture is thick and glossy.
- 3 Pour into a greased, rectangular 20 x 20cm dish, chill to set before cutting.



RECIPES

Serves 6 - 8

150ml (1/4 pint) vegetable oil
225g soft brown sugar
3 eggs (medium), beaten
175g self raising flour
5ml (1 tsp) bicarbonate of soda
1.25 ml (1/4 tsp) salt
10ml (2 tsp) cinnamon
1 tbsp mixed spice
300g carrots, grated
100g walnut halves, roughly chopped

ICING:
200g cream cheese (see tip, page 56)
grated rind of 1 lemon
5ml (1 tsp) lemon juice
30ml (2 tbsp) icing sugar
25g walnuts, finely chopped to sprinkle

MOIST CARROT CAKE

- 1 Combine the oil, sugar and eggs. Fold in the flour, bicarbonate of soda, salt, cinnamon and mixed spice. Add the carrots and walnuts, mix well.
- 2 Grease and line a 20cm soufflé dish with greaseproof paper, pour in the cake mixture.
- 3 Place on turntable, cook on COMBI - 1 (CONVECTION & MICROWAVE), 180°C, 30% for 25 minutes. Allow to cool before decorating.
- 4 To prepare icing, combine cream cheese, lemon rind, lemon juice and icing sugar until smooth. Spread on top of the cake, sprinkle with walnuts.

If iced with cream cheese, keep cake refrigerated.
Eat within 2 days.

Serves 6 - 8

225g margarine
225g caster sugar
7.5ml (1 1/2 tsp) vanilla essence
4 eggs (medium), beaten
100g plain flour
50g cocoa powder
2.5ml (1/2 tsp) baking powder
75g walnuts, roughly chopped

CHOCOLATE BROWNIES

- 1 Grease a 20cm square dish.
- 2 Combine margarine, sugar, vanilla essence and eggs, until smooth.
- 3 Stir in remaining ingredients.
- 4 Cook on COMBI - 1 (CONVECTION & MICROWAVE), 180°C, 10% for 30 minutes until firm to the touch.

Serves 8

250g self raising flour
Large pinch of salt
175g butter, cut into small pieces
100g ground almonds
100g caster sugar
2 eggs (medium), beaten
60ml (4 tbsp) milk
10ml (2 tsp) almond essence
150g white chocolate, chopped
300g fresh raspberries
Icing sugar, for dusting

RASPBERRY & CHOCOLATE CAKE

- 1 Grease a 20cm round cake tin and line the base with greaseproof paper.
- 2 Sift the flour and salt into a large bowl. Rub the butter into the flour until the mixture resembles breadcrumbs. Stir in the ground almonds and sugar.
- 3 Beat the eggs, milk and almond essence together and mix into the flour mixture. Add the chocolate and raspberries and mix in gently.
- 4 Spread the mixture into the cake tin, place on the low rack and cook on COMBI - 1 (CONVECTION & MICROWAVE), 180°C, 30% for 35 minutes. Allow the cake to cool. Dust with icing sugar.



RECIPES

Serves 4 - 6

100g margarine
100g caster sugar
2 eggs (medium), beaten
100g self raising flour
30 - 45ml (2 - 3 tbsps) water

PLAIN MICROWAVE CAKE

- 1 Cream margarine and sugar, beat in the eggs. Fold in the flour and water. Grease and line the base of a 18cm cake dish with kitchen paper. Spoon mixture into purex dish and smooth.
- 2 Cook on 100% for 5 minutes. Allow to cool slightly before turning out.

Serves 6

175g butter
175g caster sugar
3 eggs (medium)
175g plain flour
5ml (1 tsp) baking powder
100g glacé cherries, quartered
75g ground almonds
5ml (1 tsp) almond essence
15ml (1 tbsps) milk

CHERRY & ALMOND CAKE

- 1 Cream the butter and sugar together until light and fluffy, beat in the eggs.
- 2 Fold in flour and baking powder, stir in the cherries, ground almonds, almond essence and milk.
- 3 Grease and line the base of a 18cm cake dish with greaseproof paper. Spoon in the cake mixture and smooth the surface.
- 4 Place on the turntable, cook on COMBI - 1 (CONVECTION & MICROWAVE), 200°C, 30%, for 20 minutes.

Serves 6 - 8

175g margarine
100g caster sugar
225g self raising flour
50g milk chocolate chips
25g walnuts, finely chopped

The biscuits will be soft when hot but will harden as they cool.

CHOCOLATE CHIP COOKIES

- 1 Cream margarine and sugar until light and fluffy. Stir in the flour, chocolate and walnuts to make a soft but firm dough.
- 2 Divide mixture into 8 even sized balls, place apart in two large flan dishes and flatten slightly.
- 3 Place one dish on low rack and the other on the high rack. Bake on CONVECTION 180°C for 40 minutes until golden brown around the edges. Swap the dishes round after 20 minutes.
- 4 Allow to cool before removing from the dish.

Serves 4 - 6

100g butter
75g golden syrup
175g black treacle
225g plain flour
10ml (2 tsp) ground ginger
5ml (1 tsp) bicarbonate of soda
25g caster sugar
150ml (1/4 pint) milk
2 eggs (medium), beaten

GINGERBREAD

- 1 Place the butter, syrup and treacle into a bowl, heat on 100% for 2 minutes and stir well.
- 2 In a separate bowl, place the flour, ginger, bicarbonate and sugar.
- 3 Add the milk into the melted syrup mixture then add the eggs and mix well.
- 4 Stir into the dry ingredients and beat thoroughly.
- 5 Pour into a greased and lined 20cm square dish.
- 6 Place on the low rack and cook on COMBI - 1 (CONVECTION & MICROWAVE), 180°C, 30%, for 18 minutes.



RECIPES

Serves 4

325g potato, cooked and mashed
325g parsnips, cooked and mashed
225g self raising flour
2 cloves garlic, crushed (see tip, page 53)
10ml (2 tsp) whole grain mustard
2 eggs (medium), beaten
75ml (5 tbsp) milk
5ml (1 tsp) fresh parsley, chopped to sprinkle

POTATO BREAD

- 1 Place the potato, parsnips, flour, garlic and mustard in a large bowl, mix well.
- 2 Add the egg and milk, mix to form a soft dough. Knead the dough into a round shape approx. 20cm in diameter. Place in a 25cm flan dish, sprinkle with parsley.
- 3 Place on the low rack and cook on COMBI - 1 (CONVECTION & MICROWAVE), 230°C, 30% for 25 minutes until golden.

Serve with soup, cheese or salad.

Serves 6 - 8

175g figs, chopped
150ml (1/4 pint) boiling water
225g plain flour
125g wholemeal flour
125g caster sugar
2.5ml (1/2 tsp) salt
2.5ml (1/2 tsp) bicarbonate of soda
100g butter
125g walnuts, roughly chopped
150ml (1/4 pint) milk
1 egg (medium), beaten

FIG & WALNUT BREAD

- 1 Place figs in a large bowl, add the boiling water, leave aside to cool.
- 2 Preheat the oven to Convection 180°C.
- 3 Place flours, sugar, salt and bicarbonate of soda in a bowl, mix well. Rub in butter until mixture resembles fine breadcrumbs, stir in walnuts.
- 4 Add the fig mixture, milk and egg, mix well.
- 5 Grease and line the base of a 1.5 litre (2 1/2 pint), straight-sided loaf dish with greaseproof paper. Spoon in loaf mixture and smooth the surface.
- 6 Place on the low rack, cook in a preheated oven on COMBI - 1 (CONVECTION & MICROWAVE), 180°C, 50% for 25 minutes, until a skewer comes out cleanly.

Serve sliced, spread generously with butter.

Microwave Tip: Toasting coconut

Spread 100g desiccated coconut on a plate. Heat on 100% for 2 - 3 minutes, stir every minute.

Serves 4

225g wholemeal self raising flour
150g medium oatmeal
2.5ml (1/2 tsp) salt
2.5ml (1/2 tsp) bicarbonate of soda
50g butter
120ml (4fl.oz) natural yoghurt
90ml (6 tbsp) milk
1 egg (medium), beaten to glaze
sesame seeds to sprinkle

SODA BREAD

- 1 Combine flour, oatmeal, salt, bicarbonate of soda in a large bowl. Rub in the butter.
- 2 Add the yoghurt and milk, mix to form a soft but not sticky dough.
- 3 Knead lightly into a round shape approx. 20cm in diameter. Place in a greased 25cm flan dish.
- 4 Use a knife to mark into 8 wedges, cut only halfway through the dough. Glaze surface with egg, sprinkle with sesame seeds.
- 5 Place on low rack, bake in a preheated oven on COMBI - 1 (CONVECTION & MICROWAVE), 200°C, 10% for 20 minutes until golden.

Serve with cheese and a salad.





RECIPES

Serves 4

1.5 litres (2 pint) milk
200g pudding rice
75g caster sugar
50g butter
5ml (1 tsp) ground nutmeg (optional)

RICE PUDDING

- 1 Place all of the ingredients into a bowl. Place in the low rack and cook on COMBI - 1 (CONVECTION & MICROWAVE), 180°C, 30% for 60 minutes. Stir twice during cooking and again at the end of cooking.
- 2 Sprinkle with ground nutmeg to serve.

Makes 14 scones

450g self raising flour
100g butter
100g caster sugar
100g sultanas
2 eggs (medium), beaten with milk to make 300ml (1/2 pint)
1 egg (medium), beaten to glaze
15ml (1 tbsp) mixed herb

FRUIT SCONES

- 1 Preheat the oven to 220°C.
- 2 Place the flour in the bowl and rub in the butter.
- 3 Add the sugar and the fruit.
- 4 Mix together the milk and egg.
- 5 Make a well in the flour, add almost all of the liquid and mix with a round bladed knife.
- 6 On a floured surface, knead the dough very lightly until it is just smooth.
- 7 Divide the mixture in two, flatten until approx. 2cm thick, then cut each peice of dough into seven rounds (approx. 6.2cm each).
- 8 Grease two flan dishes, place seven scones in each dish. Place one dish on the high rack and the other dish on the low rack.
- 9 Cook on CONVECTION 220°C for 2 minutes. Swap dishes after 12 minutes, until well-risen and brown.

- Wholemeal scones:** Substitute white self raising flour with wholemeal self raising flour, omit raisins.
- Cheese & herb scones:** Omit sugar and sultanas. Add 175g grated Cheddar cheese, 15ml (1 tbsp) mixed herbs.



RECIPES

Makes 300ml (1/2 pint)

25g butter
25g plain flour
300ml (1/2 pint) milk
salt and pepper to taste

WHITE SAUCE

- 1 Place the butter in a bowl and heat on 100% for 1 minute, until melted.
- 2 Stir in the flour and whisk in the milk. Cook on 100% for 8 minutes, stir every 2 minutes until thick and smooth. Season with salt and pepper to taste.

Cheese sauce:

Stir in 75g grated cheese and 5ml (1 tsp) mustard powder at Stage 2. Serve with vegetables, fish or meat.

Parsley sauce:

Stir 15 - 30ml (1 - 2 tbsp) chopped parsley into the finished sauce. Serve with fish.

Onion sauce:

Stir 225g cooked onion, finely chopped, into the finished sauce. Heat on 100% for 1 minute before serving. Serve with meat or vegetables.

Sweet white sauce:

Omit salt and pepper from basic recipe. Add 15 - 30ml (1 - 2 tbsp) caster sugar at Stage 2. Serve with puddings as an alternative to custard.

Makes 600ml (1 pint)

125g onion, finely chopped
1 green pepper, finely chopped
2 cloves garlic, crushed
30g butter
30g plain flour
45ml (3 tbsp) white wine vinegar
30ml (2 tbsp) soy sauce
300ml (1/2 pint) hot chicken stock
50g soft dark brown sugar

SWEET & SOUR SAUCE

- 1 Place the onion, green pepper, garlic and butter in a bowl, mix well. Cook on 100% for 2 minutes.
- 2 Stir in the flour, gradually add the vinegar, soy sauce, stock and sugar. Cook on 100% for 4 minutes, stir every minute until the mixture has thickened. Blend in a food processor for a smoother sauce.

Makes 600ml (1 pint)

100g smoked streaky bacon
200g onion
100g carrot
3 tbsp tabasco sauce
2 cloves garlic, crushed
800g canned, chopped tomatoes
150ml (1/4 pint) red wine
30ml (2 tbsp) tomato puree

SPICY TOMATO SAUCE

- 1 Place bacon, carrot, onion and garlic in a large bowl, do not cover and cook on 100% for 3 minutes.
- 2 Add all other ingredients to bacon mixture and mix well. Cook 70% for 30 minutes, stir twice during cooking.
- 3 Blend in a food processor until smooth, return to bowl and cook on 70% for 3 minutes.

Makes 300ml (1/2 pint)

25g butter
45ml (3 tbsp) whole grain mustard
200ml (7fl.oz) soured cream
salt and pepper to taste

MUSTARD SAUCE

- 1 Place butter in a bowl, heat on 100% for 30 seconds. Add the mustard, soured cream, salt, and pepper, mix well.
- 2 Cook on 100% for 4 minutes, stir every minute, until smooth and thick.

Serve with meat or fish.





RECIPES

Makes 450ml (3/4 pint)

75g Blue Stilton cheese, finely chopped
300ml (1/2 pint) soured cream
150ml (1/4 pint) white wine
15ml (1 tbsp) cornflour blended with water
30ml (2 tbsp) fresh parsley, chopped
salt and pepper to taste

BLUE CHEESE SAUCE

- 1 Place the cheese, cream wine, cornflour and parsley in a bowl, mix well. Season.
- 2 Heat on 100% for 8 minutes, stir three times during cooking and again before serving.

Ideal served with pasta.

Makes 600ml (1 pint)

50g butter
50g plain flour
75g brown sugar
15ml (1 tbsp) golden syrup
150ml (1/4 pint) double cream
300ml (1/2 pint) milk
60ml (4 tbsp) brandy to taste

BRANDY SAUCE

- 1 Place butter in a bowl, heat on 100% for 1 minute until melted. Stir in flour, heat on 100% for 1 minute.
- 2 Combine sugar, syrup, cream and milk, heat on 100% for 2 minutes.
- 3 Gradually add cream mixture to the butter and flour mixture. Heat on 100% for 5 minutes, stir every minute until smooth and thick. Stir in brandy.





GUARANTEE

Sharp Electronics (UK) Ltd. ("Sharp") guarantees that for a period of 12 months from the date of purchase the enclosed product will be free from defects in materials and workmanship. Sharp agrees to provide for the repair or, at its option, the replacement of a defective product. Sharp reserves the right to replace defective parts, or the product, with new or refurbished items. Items that are replaced become the property of Sharp.

To benefit from this guarantee, any fault that occurs must be notified to Sharp, or its appointed Service Facility, within one year from the date the product was purchased. Proof of purchase, such as a receipt or invoice, must be provided.

If the product is exchanged, the replacement shall be covered by the unexpired portion of the original guarantee.

In the unlikely event of the product requiring repair, please contact the supplier from whom it was purchased. Where this is not possible, please contact an appointed Service Facility. Details of Service Facilities appointed by Sharp can be obtained from www.sharp.co.uk/customersupport/service or by contacting the **Sharp Customer Information Centre** whose details are given below.

This guarantee shall only apply to faults that are due to inferior workmanship or materials. It does not cover faults or damage caused by accident, misuse, fair wear and tear, neglect, tampering with the product, or repair other than by a Service Facility appointed by Sharp.

The product is intended for private domestic use only. The guarantee will not apply if the product is used in the course of a business, trade or profession.

The guarantee does not cover:

- Glass/ceramic turntables, as they can be damaged by handling/cleaning methods.
- Faults resulting from inadequate cleaning. Regular cleaning is required to prevent a build up of food residue that can also affect the performance of the product.
- Carriage costs to or from the repair centre.

No person has any authority to vary the terms or conditions of this guarantee.

This guarantee is offered as an additional benefit to your statutory rights, and does not affect these rights in any way.

You may not transfer your rights or obligations under this warranty to anyone else.

If you have any difficulty operating the product, or would like information on other Sharp products, please telephone the Sharp Customer Information Centre on the number given below.

Sharp Customer Information Centre

Website: www.sharp.co.uk/customersupport

Telephone: 08705 274277 (01 676 0648 in Southern Ireland)

Sharp Electronics (UK) Ltd. is a company registered in England under number 965877 whose registered office is at
4 Furzeground Way, Stockley Park, Uxbridge, Middlesex, UB11 1EZ.



SPECIFICATIONS

AC Line Voltage Single phase 230-240V, 50Hz

Power Consumption:

Microwave	1.50kW
Top Grill	1.25kW
Bottom Grill.	0.70kW
Convection	1.91kW
Top and Bottom Grill	1.90kW
Microwave/Top Grill	2.70kW
Microwave/Bottom Grill	2.15kW
Microwave/Convection	2.16kW

Input Current:

Microwave 6.5A

Output Power:

Microwave	900W (IEC 60705)
Top Grill	1200W
Bottom Grill.	650W
Convection	1850W

MAFF Heating Category E

Microwave Frequency 2450MHz * (Group 2/Class B)

Outside Dimensions 520(W) x 309(H) x 486(D)mm **

Cavity Dimensions 343(W) x 209(H) x 357(D)mm ***

Oven Capacity 26 litres ***

Cooking uniformity. Turntable diameter 325mm

Weight Approx. 19kg

- * This Product fulfils the requirement of the European standard EN55011. In conformity with this standard, this product is classified as group 2 class B equipment. Group 2 means that the equipment intentionally generates radio-frequency energy in the form of electromagnetic radiation for heating treatment of food. Class B equipment means that the equipment is suitable to be used in domestic establishments.
- ** The depth does not include the door opening handle.
- *** Internal capacity is calculated by measuring maximum width, depth and height. Actual capacity for holding food is less.

As part of a policy of continuous improvement, we reserve the right to alter design and specifications without notice. No part of this publication may be reproduced, stored in a retrieval system or transmitted in any form, electronic, mechanical, photocopying, recording, translating or other means without prior permission from SHARP Electronics (U.K.) Ltd.

The illustrations, technical information and data contained in this publication are, to our best knowledge, correct at the time of going to print. The right to change specifications, at any time, without notice, is reserved a part of our policy of continuous development and improvement.





SHARP

Sharp Electronics (UK) Ltd.
London, UK

UK: 08705 274277 (office hours)
Ireland: 01 676 0648 (office hours)
Website: <http://www.sharp.co.uk/support>

PRINTED IN THAILAND
TINS-A755WRRZ-K81

Free Manuals Download Website

<http://myh66.com>

<http://usermanuals.us>

<http://www.somanuals.com>

<http://www.4manuals.cc>

<http://www.manual-lib.com>

<http://www.404manual.com>

<http://www.luxmanual.com>

<http://aubethermostatmanual.com>

Golf course search by state

<http://golfingnear.com>

Email search by domain

<http://emailbydomain.com>

Auto manuals search

<http://auto.somanuals.com>

TV manuals search

<http://tv.somanuals.com>