

SHURE®

LEGENDARY
PERFORMANCE™

Wired Microphones
VP82

VP82

Compact Shotgun Microphone
Microphone canon compact
Kompaktes Richtrohrmikrofon
Micrófono de cañón compacto
Microfono a canna di fucile compatto
Компактный линейный микрофон
コンパクトショットガンマイクロホン
컴팩트 샷건 마이크
紧凑型枪式话筒



www.shure.com
© 2013 Shure Incorporated
Printed in U.S.A.
27A15531 (Rev. 2)



N108



CE

General Description

The VP82 is a professional shotgun microphone for use in sound capture and reinforcement. Compact and lightweight, with wide aperture and excellent off-axis rejection, the VP82 is the affordable and reliable choice for camera-mounted A/V media production applications.

Features

- Premier production microphone crafted with Shure quality, ruggedness, and reliability
- Highly directional, uniform polar pattern optimized for distant pickup
- Low self-noise and high output level
- Lightweight, compact design accommodates prolonged operation, minimizing operator fatigue attributed to many shotgun microphones
- Class A, discrete, transformerless preamplifier provides transparent, extremely fast transient response with no crossover distortion and minimal harmonic and intermodulation distortion
- Aircraft-grade aluminum alloy construction resists wear and abuse
- Operates over a wide range of temperatures and humidity

Rycote Custom Accessories

Shure offers custom Rycote® suspension mounting and wind-protection solutions designed for Shure VP shotgun microphones.

Wind-Protection

Use the supplied foam windscreen to reduce wind-noise. For increased protection, Shure offers two premium Rycote® windshield accessories:

- **Softie Windshield:** Attenuates up to 25 dB of wind-noise.
- **Suspension Windshield Kit:** Attenuates up to 38 dB of wind-noise while preserving critical high frequencies. Included Lyre suspension mounts provide up to 25 dB of isolation.

Suspension Mounts

Shure offers four Rycote® Softie Lyre Mounts to reduce handling noise and low-frequency vibrations by up to 15 dB:

- **InVision Video:** Secures directly onto standard camera shoe.
- **Camera Clamp Adapter (CCA):** Fits into a standard camera clamp.
- **Pistol Grip:** Adjustable handheld mount.

Note: All Softie Lyre Mounts (except InVision Video) are equipped with 3/8" and 5/8" female threaded adapters for additional mounting options.

XLR Connector Gasket

This microphone is supplied with a small corrugated rubber ring in the XLR connector to absorb the mechanical slack between the microphone and cable. Many high-end cables are made with a rubber shoulder on the XLR-F for the same purpose. When connecting this microphone to a cable with a rubber shoulder XLR-F connector, remove the corrugated rubber ring from the microphone to ensure a proper fit.

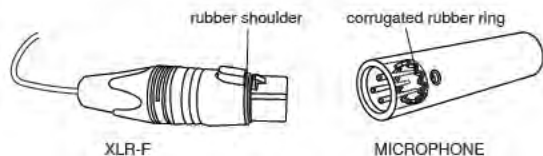

Load Impedance

Maximum SPL capability, output clipping level, and dynamic range vary with the input load impedance of the preamplifier to which the microphone is connected. Shure recommends a minimum input load impedance of 1000 Ohms. Most modern microphone preamplifiers meet this requirement. Higher impedance results in better performance for these specifications.

Power Requirements

This microphone requires phantom power and performs best with a 48 V DC supply (IEC-61938), but it can operate with supplies as low as 11 V DC. Most modern mixers provide phantom power and require the use of a **balanced** microphone cable: XLR-to-XLR or XLR-to-TRS.

Specifications

Cartridge Type	Electret Condenser	
Polar Pattern	Supercardoid/lobar	
Frequency Response	90 to 20,000 Hz	
Output Impedance	144 Ω	
Sensitivity open circuit voltage, @ 1 kHz, typical	-36.0 dBV/Pa ⁽¹⁾ (15.8 mV)	
Maximum SPL 1 kHz at 1% THD ⁽²⁾	2500 Ω load:	137.5 dB SPL
	1000 Ω load:	131.5 dB SPL
Signal-to-Noise Ratio⁽³⁾	79 dB	
Dynamic Range @ 1 kHz	2500 Ω load:	122.5 dB
	1000 Ω load:	116.5 dB
Clipping Level @ 1 kHz, 1% THD	2500 Ω load:	7.0 dBV
	1000 Ω load:	0.0 dBV
Self Noise equivalent SPL, A-weighted, typical	15.0 dB SPL-A	
Common Mode Rejection 20 to 20,000 Hz	≥55 dB	
Operating Temperature Range	-18°C (0°F) to 57°C (135°F)	
Storage Temperature Range	-29°C (-20°F) to 74°C (165°F)	
Operating Relative Humidity	0 to 95%	
Polarity	Positive pressure on diaphragm produces positive voltage on pin 2 with respect to pin 3	
Housing	Satin-black vinyl painted aluminum alloy with stainless steel screen	
Power Requirements	11–52 V DC ⁽⁴⁾ phantom power (IEC-61938), <2.0 mA	
Net Weight	76 g (2.7 oz.)	

⁽¹⁾ 1 Pa=94 dB SPL

⁽²⁾THD of microphone preamplifier when applied input signal level is equivalent to cartridge output at specified SPL

⁽³⁾S/N ratio is the difference between 94 dB SPL and equivalent SPL of self noise, A-weighted

⁽⁴⁾All specifications measured with a 48 Vdc phantom power supply. The microphone operates at lower voltages, but with slightly decreased headroom and sensitivity.

Zippered Carrying Bag

Fourre-tout pour le transport à fermeture éclair

Tragetasche mit Reißverschluss

Bolsa para transporte con cremallera

Custodia con cerniera, adatta per il trasporto

Футляр на застёжке-молнии

ジッパー付きキャリングバッグ

지퍼가 부착된 휴대용 백

拉链便携包



95A2313

Foam Windscreen

Bonneste anti-vent en mousse

Schaumstoff-Windschutz

Paravientos de espuma

Antivento in schiuma poliuretanic

Пенопластовый ветрозащитный экран

フォームウィンドスクリーン

폼 윈드스크린

海绵防尘罩

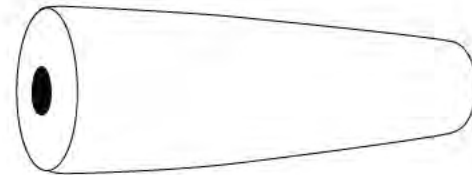

A89SW

Optional AccessoriesAccessoires fournis
Mitgeliefertes ZubehörAccesorios suministrados
Accessori in dotazioneОтдельно заказываемые
аксессуары付属アクセサリ
기본 제공 액세서리

可选配附件

Rycote® Windshield Kit

Kit de bonnette de protection

Windschutzsatz

Juego de paravientos

Kit antivento

Комплект ветрозащитного подвеса

ウィンドシールドキット

윈드실드 키트

防风套件

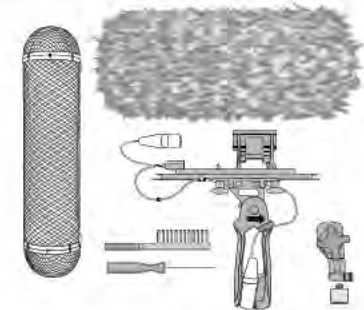
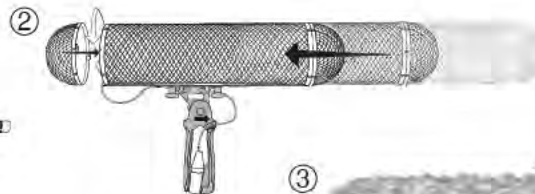
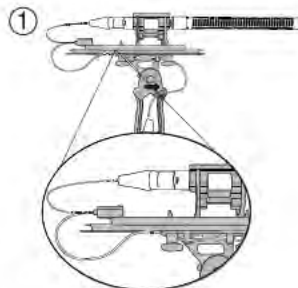

A89SW-KIT

Rycote® Softie Windshield

Bonnets de protection Softie

Softie-Windschutz

Paravientos Softie

Antivento Softie

Ветрозащитный экран Softie

ソフティウィンドシールド

Softie Windshield:

柔性防风罩

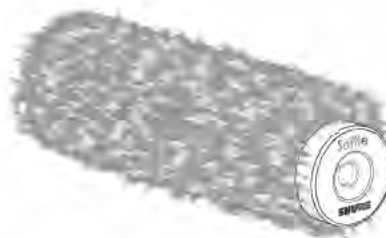
**A89SW-SFT****Rycote® Softie Lyre Mount with InVision Video (Shoe)**

Monture Softie Lyre avec InVision Video (griffe)

Softie Lyre-Erschütterungsabsorbier mit InVision Video (Schuh)

Montaje Softie Lyre con InVision Video (zapata)

Supporto a lira Softie con InVision Video (slitta)

Onopa Softie Lyre Mount c InVision Video (башмак)

用InVisionビデオ (シュー) 使用ソフティリラマウント

InVision Video (Shoe)를 사용하는 Softie Lyre Mount

的帶 InVision Video 熱靴 Softie Lyre 固定件

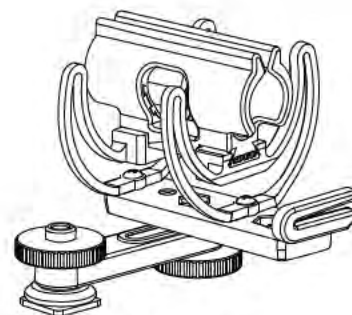
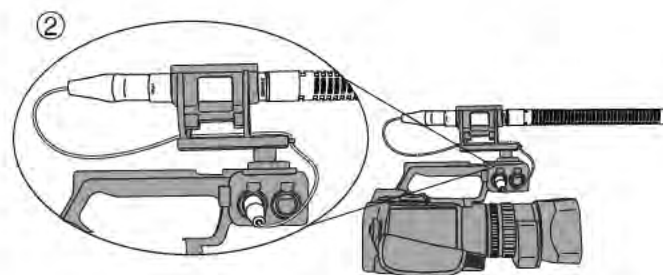
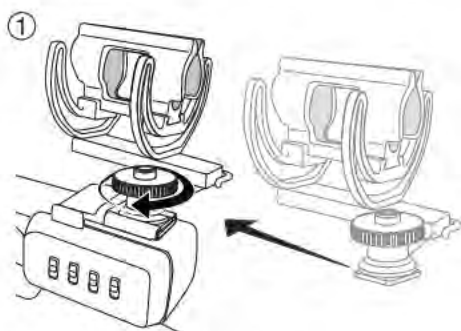
**A89M-SH**

Rycote® Softie Lyre Mount with Pistol Grip

Monture Softie Lyre avec poignée-pistolet

Softie Lyre-Erschütterungsabsorber mit Pistolengriff

Montaje Softie Lyre con empuñadura tipo pistola

Supporto a lira Softie con impugnatura a pistola

Опора Softie Lyre Mount с пистолетной рукояткой

ピストルグリップ使用ソフティリラマウント

용 피스틀 그립을 사용하는 Softie Lyre Mount

的手枪式握把的 Softie Lyre 固定件

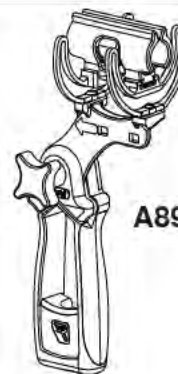
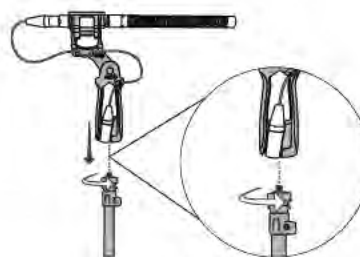
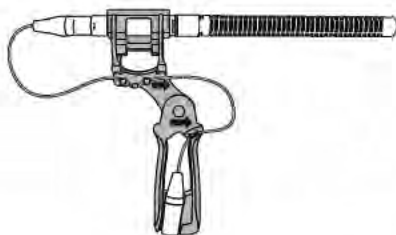
**A89M-PG****Rycote® Softie Lyre Mount with Camera Clamp Adapter**

Monture Softie Lyre avec adaptateur de pince pour caméra

Softie Lyre-Erschütterungsabsorber mit Kameraklemmadapter

Montaje Softie Lyre con adaptador para pinza de cámara

Supporto a lira Softie con adattatore del morsetto per videocamera

Опора Softie Lyre Mount с адаптером CCA

用カメラクランプアダプタ使用ソフティリラマウント

용 카메라 클램프 어댑터를 사용하는 Softie Lyre Mount

的相机夹具转接器 Softie Lyre 固定件

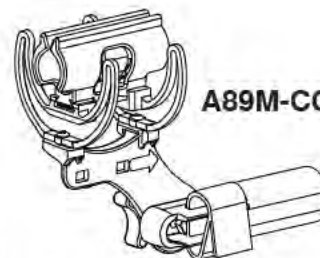
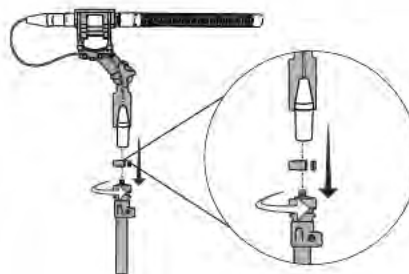
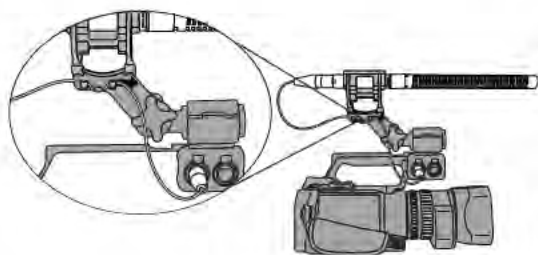
**A89M-CC**

VP82

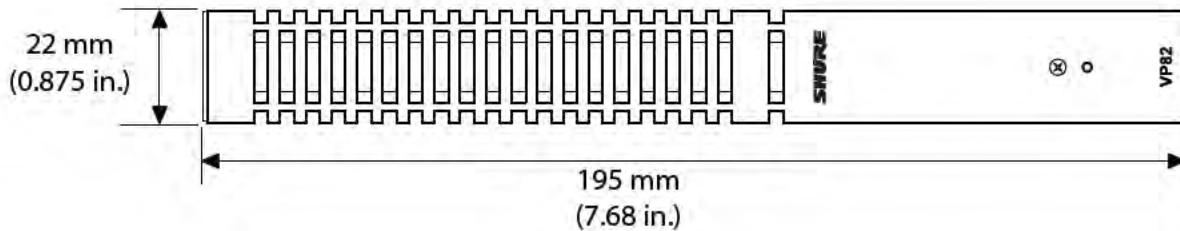
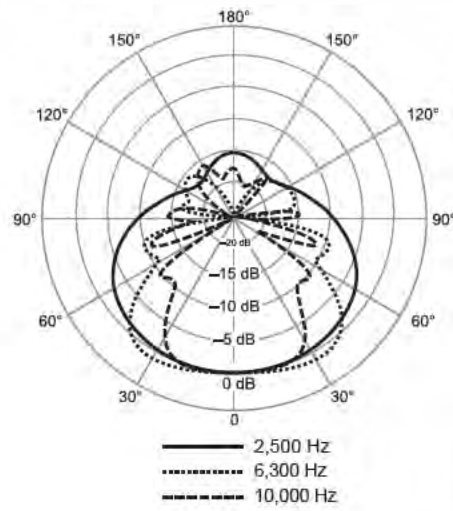
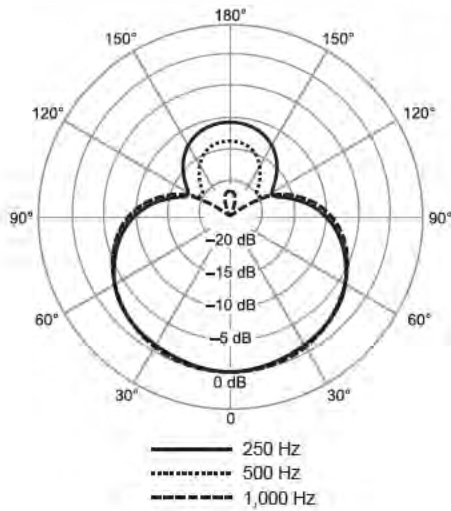
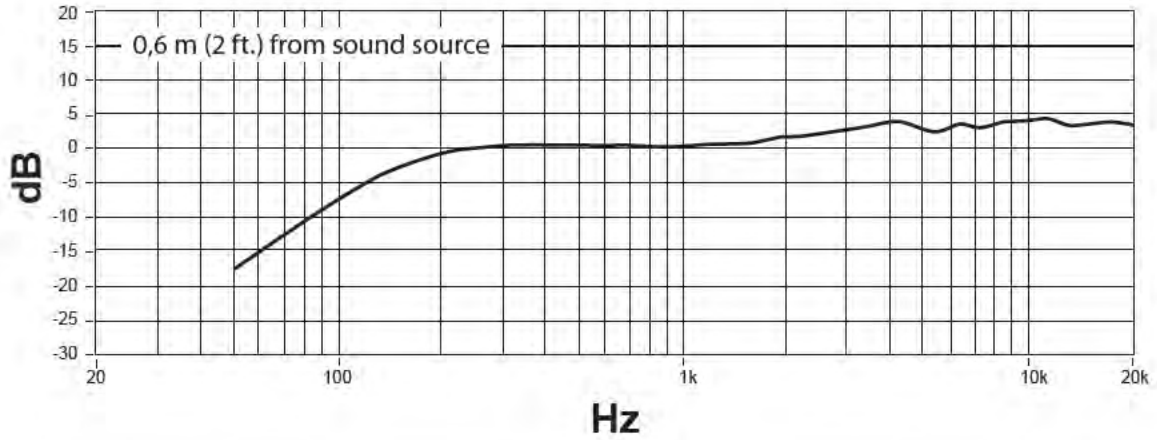

Certifications

Eligible to bear CE Marking. Conforms to European EMC Directive 2004/108/EC. Meets Harmonized Standards EN55103-1:1996 and EN55103-2:1996, for residential (E1) and light industrial (E2) environments.

The CE Declaration of Conformity can be obtained from: www.shure.com/europe/compliance

Authorized European representative:
Shure Europe GmbH
Headquarters Europe, Middle East & Africa
Department: EMEA Approval
Jakob-Dieffenbacher-Str. 12
75031 Eppingen, Germany
Phone: 49-7262-92 49 0
Fax: 49-7262-92 49 11 4
Email: info@shure.de

Note: Information in this guide is subject to change without notice. For additional information about this product, please visit www.shure.com.

Homologations

Autorisé à porter la marque CE. Conforme à la directive européenne CEM 2004/108/CE. Conforme aux normes harmonisées EN55103-1:1996 et EN55103-2:1996 pour les environnements résidentiels (E1) et d'industrie légère (E2).

La déclaration de conformité CE peut être obtenue auprès de : www.shure.com/europe/compliance

Représentant agréé européen :
Shure Europe GmbH
Siège Europe, Moyen-Orient et Afrique
Service : Homologation EMA
Jakob-Dieffenbacher-Str. 12
75031 Eppingen, Allemagne
Téléphone : 49-7262-92 49 0
Télécopie : 49-7262-92 49 11 4
Courriel : info@shure.de

Remarque : Les informations dans ce guide sont sujettes à modification sans préavis. Pour plus de détails sur ce produit, visiter www.shure.com.

Zulassungen

Zur CE-Kennzeichnung berechtigt. Entspricht der europäischen Richtlinie zur elektromagnetischen Verträglichkeit 2004/108/EG. Entspricht den Anforderungen der harmonisierten Normen EN55103-1:1996 und EN55103-2:1996 für Wohngebiete (E1) und Leichtindustriegebiete (E2).

Die CE-Übereinstimmungserklärung ist erhältlich bei: www.shure.com/europe/compliance

Bevollmächtigter Vertreter in Europa:
Shure Europe GmbH
Zentrale für Europa, Nahost und Afrika
Abteilung: EMEA-Approval
Jakob-Dieffenbacher-Str. 12
75031 Eppingen, Deutschland
Telefon: +49 (0) 7262 9249 0
Telefax: +49 (0) 7262 9249 114
E-Mail: info@shure.de

Hinweis: Änderungen der Informationen in diesem Handbuch vorbehalten. Weitere Informationen über dieses Produkt finden Sie im Internet: www.shure.de.

Certificaciones

Califica para llevar la marca CE. Cumple con la directiva europea de EMC 2004/108/EC. Satisface las normas armonizadas EN55103-1:1996 y EN55103-2:1996 para entornos de uso residencial (E1) e industrial ligero (E2).

La declaración de homologación de CE se puede obtener en: www.shure.com/europe/compliance

Representante europeo autorizado:
Shure Europe GmbH
Casa matriz en Europa, Medio Oriente y Africa
Departamento: Aprobación para región de EMEA
Jakob-Dieffenbacher-Str. 12
75031 Eppingen, Alemania
Teléfono: 49-7262-92 49 0
Fax: 49-7262-92 49 11 4
Correo electrónico: info@shure.de

Nota: La información contenida en esta guía está sujeta a cambios sin previo aviso. Para información adicional sobre este producto, visite www.shure.com.



**United States, Canada, Latin
America, Caribbean:**

Shure Incorporated
5800 West Touhy Avenue
Niles, IL 60714-4608 USA

Phone: 847-600-2000
Fax: 847-600-1212 (USA)
Fax: 847-600-6446
Email: info@shure.com

Europe, Middle East, Africa:

Shure Europe GmbH
Jakob-Dieffenbacher-Str. 12,
75031 Eppingen, Germany

Phone: 49-7262-92490
Fax: 49-7262-9249114
Email: info@shure.de

Asia, Pacific:

Shure Asia Limited
22/F, 625 King's Road
North Point, Island East
Hong Kong

Phone: 852-2893-4290
Fax: 852-2893-4055
Email: info@shure.com.hk

Free Manuals Download Website

<http://myh66.com>

<http://usermanuals.us>

<http://www.somanuals.com>

<http://www.4manuals.cc>

<http://www.manual-lib.com>

<http://www.404manual.com>

<http://www.luxmanual.com>

<http://aubethermostatmanual.com>

Golf course search by state

<http://golfingnear.com>

Email search by domain

<http://emailbydomain.com>

Auto manuals search

<http://auto.somanuals.com>

TV manuals search

<http://tv.somanuals.com>