

User Guide

Overdrive™ 3G/4G Mobile Hotspot

by Sierra Wireless

www.sprint.com



©2010 Sprint. SPRINT and the logo are trademarks of Sprint.
Other marks are the property of their respective owners.

1/6/10



Table of Contents

Section 1: Getting Started	1
1A. Device Basics	2
Your Device	3
Components of Your Device	3
3G and 4G Networks	4
Package Contents	4
Care and Maintenance	5
About This Guide	5
1B. Getting Started	6
System Requirements	6
Section 2: Your Device	7
2A. Your Device	8
Battery	9
Connecting Through USB	10
Charging the Device	11
Power Button	13
LCD	16
Mute Switch	17
microSD Card Slot	17
Section 3: Setting up the Device	19
3A. Setting Up Your Device	20
Setting Up Your Device on Your Account	20
Setting Up the Device	20
Section 4: Using Your Device	25
4A. Connecting Through USB	26
TRU-Install	26
Requirements for a USB Tethered Connection	26
Making a Tethered Connection	27
4B. Browser Interface Home Page	29
Displaying the Home Page of the Device	31
Logging On as an Administrator	31
Virtual Device	32
Mini Window	32
Turning Your Device Off	33
4C. Alerts	34
3G Activation Required	34
3G Network Update Available	35
GPS Privacy Agreement	35
SD Card Error	36
Software Update Available	36

4D. Your Network Connection	38
Launching Your Network Connection	38
Sharing Your Connection	38
Ending Your Network Connection	39
4E. Vertical Row (of Icons and Text)	40
Signal Information	41
Mobile Broadband Information and Settings	42
3G Roaming Information and Settings	43
Alert Information	43
GPS Information and Settings	44
Wi-Fi Users Information and Settings	45
Battery Information and Settings	46
Internet Connection Information	47
microSD Card Information and Settings	47
Sounds Information and Settings	48
4F. Home Page Buttons	49
Buttons Along the Top of the Home Page	49
Buttons Below the Virtual Device	51
4G. Using the microSD Card	52
Before Using the microSD Card Slot	52
Inserting a microSD Card	53
Removing a microSD Card	54
Accessing the microSD Card	54
4H. Sprint Location Services	56
Requirements for GPS Service	56
Enabling GPS	56
Displaying Your Location Information	56
Viewing Your Current Location in a Web Browser	57
Performing a Location Search	57
4I. Updates	58
Automatically Checking for Updates	58
Manually Checking for Updates	59
Upgrading Firmware From a File	60
4J. Viewing Device Information	62
4K. Reset Button	64
Restarting the Device	65
Section 5: Settings	67
5A. Power Settings	68
Battery and USB Power Settings	68
AC Power Settings	68
5B. Configuring the LCD	69
Turning the LCD On or Off	69
Setting the LCD Timeout	69
Setting the LCD Brightness	69

5C. Enabling and Disabling the LED	70
5D. Sounds	71
Enabling and Disabling Sounds for Specific Events	71
Low Battery Alert	72
Critical Battery Level Alert	72
5E. Login Settings	73
Changing the Administrator Password	73
Automatic Login ("Remember Me")	73
5F. Advanced Settings	74
Accessing the Advanced Settings Window	74
Device Tab	74
WAN Tab	78
Wi-Fi Tab	81
5G. Configuring the Wi-Fi Network	83
SSID (Wi-Fi Network Name)	83
Wi-Fi Security	85
Host Name (Device Name)	89
Setting the Maximum Number of Wi-Fi Users	89
Wi-Fi Channel	90
Disabling Wi-Fi When Connected Through USB	90
5H. Configuring 3G/4G	91
Viewing 3G Activation Information	91
3G Panel	91
Resetting the 3G/4G Configuration to Default Settings	92
5I. GPS Settings	93
Setting the GPS Mode	93
Setting the GPS Fix Rate	94
Using Metric Units	94
Changing Your Mapping Service	94
Performance Setting (GPS)	94
Accuracy	95
5J. Configuring the Router Tab	96
Basic Panel	96
LAN Panel	97
Port Forward Panel	101
Port Trigger Panel	103
DMZ Panel	104
Resetting the Software to Default Settings	105
5K. Exporting and Importing Settings	108
Exporting Settings	108
Importing Settings	108
5L. Logs	109
Logs Available	109
Connection History	109
System Events	110

Setting the Method Used for Time Acquisition.	111
5M. Setup Pages	112
Welcome to Your Device Window - Select an Option	112
Section 6: Resources	113
6A. More Information	114
Visiting the Sprint Website.	114
Contacting Customer Service.	114
Online Help	114
6B. Frequently Asked Questions	116
How Can I Tell I'm Connected to 3G/4G?	116
How Do I Connect to Wi-Fi?	116
Is Roaming on 4G Supported?	117
What Do I Do if I Forgot the Wi-Fi Password?	117
What Do I Do if I Forgot the Administrator Password?	117
If the Connection is "Always On," Am I Always Being Billed?	117
Questions About GPS and Sprint Location Services	117
How Do I Access My Corporate Network Through a VPN?	118
Are Terminal Sessions Supported?	118
6C. Tips	119
Extending Battery Life.	119
Device Location.	120
Improving Signal Strength.	120
Improving 3G Network Service.	120
Improving Wi-Fi Performance.	121
Security Tips	122
Finding the MAC Address.	122
Finding the IP Address.	123
6D. Troubleshooting Tips	124
General Tips	124
LCD Is Dark	124
Insufficient Signal Strength	125
Messages Displayed on the Device LCD	125
Cannot Connect to Wi-Fi.	127
Cannot Display the Home Page.	127
Cannot Connect to the 3G/4G Network	129
Sprint Location Services Aren't Working or Don't Seem to Be Available.	129
GPS Fix Not Available	129
Cannot Check for Updates	129
Sounds Are Enabled, but the Device Doesn't Generate Any Sounds	129
Section 7: Technical Specifications, Safety Information, and Regulatory Information.	131
7A. Technical Specifications	132
LED Operation.	132
Radio Frequency and Electrical Specifications	133

Software Specifications	134
Environmental Specifications	135
Mechanical Specifications.....	135
7B. Safety Information	136
Important Notice	136
Safety and Hazards	136
7C. Regulatory Notices	138
7D. Legal	139
Patents	139
Trademarks	139
Copyright	140
Limitation of Liability	140
Additional Information and Updates	140
<i>Index.....</i>	<i>141</i>

Section 1

Getting Started



Section 1A

Device Basics

- ◆ Your Device (page 3)
- ◆ Components of Your Device (page 3)
- ◆ 3G and 4G Networks (page 4)
- ◆ Package Contents (page 4)
- ◆ Care and Maintenance (page 5)
- ◆ About This Guide (page 5)

Your device allows you to easily connect to the Internet and to share your 3G/4G connection with others.

This user guide describes how to set up your device and use the browser interface to:

- View the status of your device.
- View and change the settings of your device and the browser interface.

It also describes your device (its various connectors and buttons).

Your Device

The device provides a simple way to use your 3G/4G Internet connection with any Wi-Fi-enabled device, and to share your Internet connection with friends and family.



Components of Your Device

Your device consists of these main components:

- Wi-Fi access point

The Wi-Fi access point connects your computers and other Wi-Fi-enabled devices to your device.

- 3G modem

The 3G modem connects your device to the Internet via the 3G (CDMA 1X/EVDO) network (more widely available, compared to 4G).

- 4G modem

The 4G modem connects your device to the Internet via the 4G (WiMAX) network (newer technology and faster speeds, compared to 3G).

- Routing hardware

The routing hardware handles traffic between the 3G/4G modems, the Wi-Fi access point, and the Wi-Fi network.

3G and 4G Networks

These wireless networks connect you to the Internet. Depending on your coverage area, you may have:

- Both 3G and 4G coverage
- Only 3G coverage
- Only 4G coverage.

Your device automatically connects to the fastest network that is available to you. If you have both 3G and 4G coverage and your connection happens to get disrupted, your device can automatically switch to the other network. For more information, see “Configuring the 3G/4G Connection Preferences” on page 42.

Download speeds

Actual speeds depend on several factors, including network conditions.

Wireless mode	Maximum downlink speeds	Typical downlink speeds
3G (EV-DO Rev. 0)	2.4 Mbps	400–700 kbps
3G (EV-DO Rev. A)	3 Mbps	0.6–1.4 Mbps
4G	10 Mbps	3–6 Mbps

Package Contents

Your package includes:

- Overdrive™ 3G/4G Mobile Hotspot by Sierra Wireless
- Battery compartment cover
- Rechargeable battery
- AC charger with USB port
- USB to Micro B cable
- Get Started guide

Care and Maintenance

As with any electronic device, you should handle this device with care to ensure reliable operation. Follow these guidelines in using and storing the device:

- Protect the device from liquids, dust, and excessive heat.
- Do not handle or operate the device while driving or operating a vehicle. Doing so may distract you from properly operating the vehicle. In some jurisdictions, operating communication devices while in control of a vehicle is a criminal offense.
- Do not apply adhesive labels to the device. They may cause the device to overheat and may alter the antenna's performance.

About This Guide

This user guide is designed to provide you with all the information you need to install and use your Overdrive 3G/4G Mobile Hotspot by Sierra Wireless.

Note: The printed Get Started guide that comes with the device should be sufficient for most installations.

- Chapter 1 (which you are reading) gives you an overview of the device.
- Chapter 2 describes the buttons, connectors, and other components of the device. (See “Your Device” on page 7.)
- Chapter 3 provides step-by-step instructions for setting up the device. (See “Setting up the Device” on page 19.)
- Chapter 4 describes common tasks for your device. (See “Using Your Device” on page 25.)
- Chapter 5 describes advanced configuration of the device and the browser interface. (See “Settings” on page 67.)
- Chapter 6 contains frequently asked questions, troubleshooting tips, and resources for getting help. (See “Resources” on page 113.)
- Chapter 7 lists the electrical, radio frequency, and other parameters of the device for those who require technical information, as well as safety information, regulatory information, and legal information. (See “Technical Specifications, Safety Information, and Regulatory Information” on page 131.)

◆ System Requirements (page 6)

System Requirements

- One or more computers that support Wi-Fi (802.11b/g)
- Web browser (required if you'll be using the browser interface to view status and to configure settings). The following browsers are supported:
 - Internet Explorer (version 6.0 or higher)
 - Mozilla Firefox (version 2.0 or higher)
 - Google Chrome (version 2.0.172.28 or higher)
 - Apple Safari (version 2.0 or higher)
 - Opera version 9.64
- If you'll be connecting the device through USB:
 - Computer running Windows 7, Windows Vista, Windows XP, or Mac (OS X 10.4.x or higher)
 - USB 2.0 slot

Section 2

Your Device



Section 2A

Your Device

- ◆ Battery (page 9)
- ◆ Connecting Through USB (page 10)
- ◆ Charging the Device (page 11)
- ◆ Power Button (page 13)
- ◆ LCD (page 16)
- ◆ Mute Switch (page 17)
- ◆ microSD Card Slot (page 17)

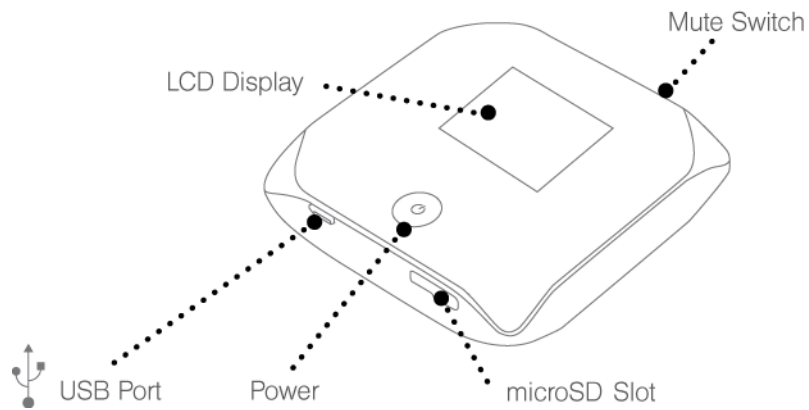

Battery

The battery compartment is on the back of the device. The battery is replaceable. (If you need a new battery, visit the Sierra Wireless online store at <https://www.sierrawireless.com/eStore>.)

Installing the Battery

1. Remove the battery compartment cover.

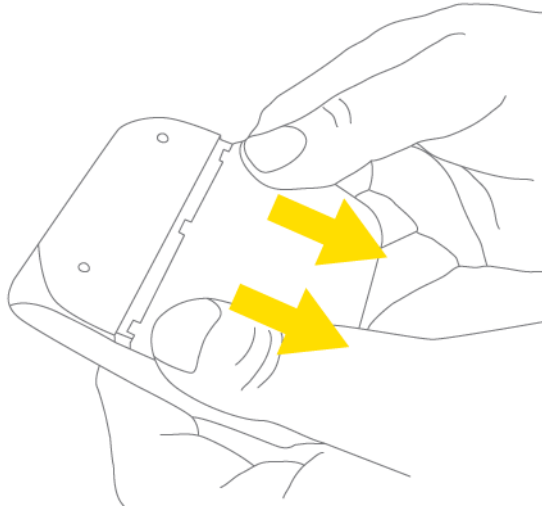

2. Insert the battery into the device. Make sure the battery contact points are aligned with those inside the battery compartment.

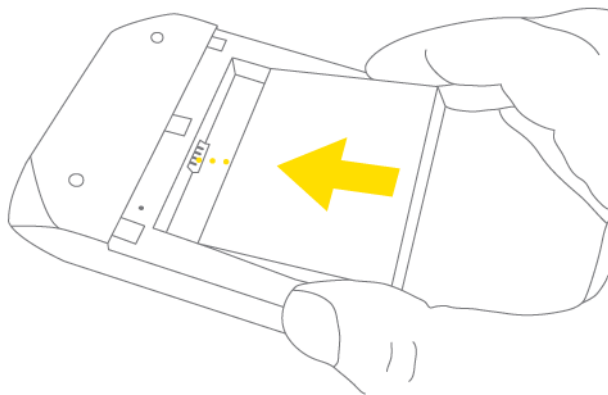

3. Replace the battery compartment cover.

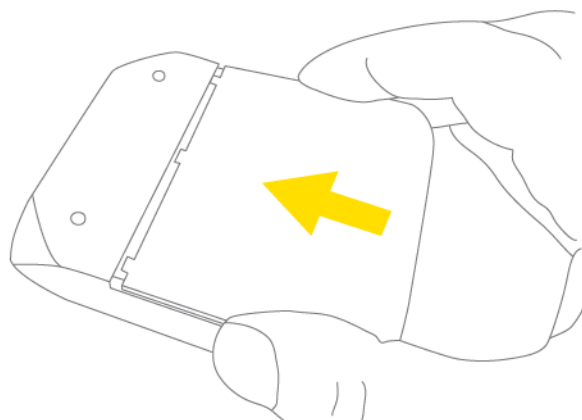

Connecting Through USB

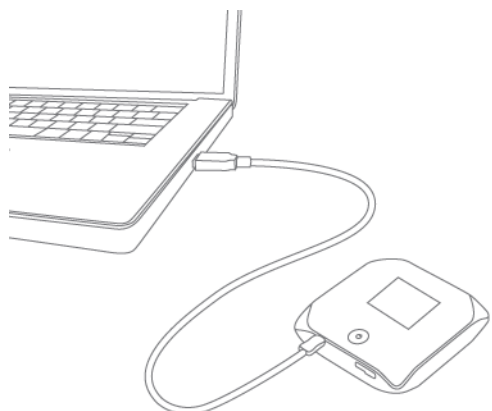

Note: If you'll be using USB for data transfer (and not just for charging the device), you must install the device driver. See "Making a Tethered Connection" on page 27.

Use the USB to Micro B cable to connect the device to your computer when:

- You want to charge the device, but you don't want to use the AC charger, or the AC charger is not available.
- Your computer does not have Wi-Fi.
- You want to block others from using the device. (See "Disabling Wi-Fi When Connected Through USB" on page 90.)

To connect the device to your computer:

1. Insert the larger (USB) end of the USB to Micro B cable into the computer.
2. Insert the other (Micro B) end of the USB to Micro B cable into the USB connector on the side of the device.

Charging the Device

You need to recharge your device's battery periodically. You can continue using your device while it is charging.

To charge the battery, you have two options, as shown in the drawing below. You can connect the device to an AC charger (faster way to charge). (See "Using the AC Charger with USB Port" on page 12.) Alternatively, you can connect the device to a computer (slower way to charge). (See "Charging Through a Computer" on page 13.)

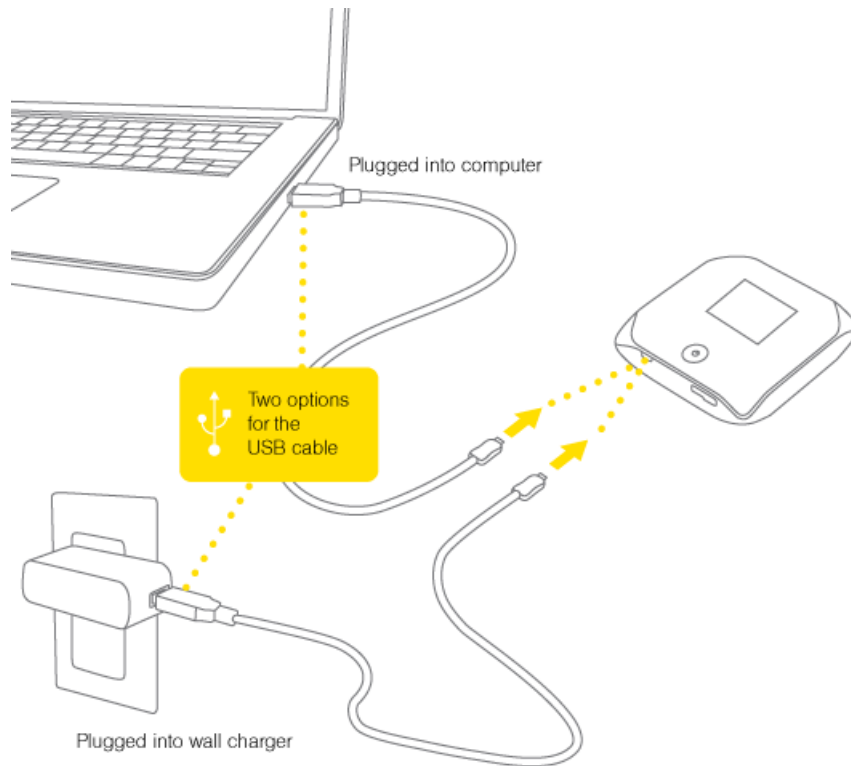

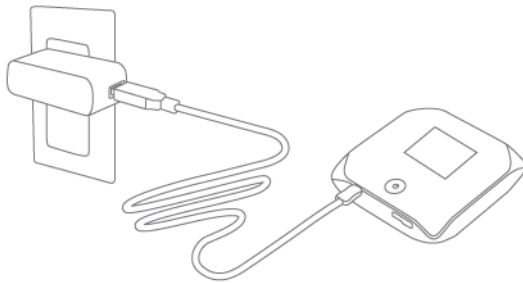

Using the AC Charger with USB Port



1. Insert the smaller (Micro B) end of the USB to Micro B cable into the USB connector on the side of the device.
2. Insert the other end of the USB to Micro B cable into the AC charger.
3. Insert the AC charger into an electrical outlet.

When charging, the LCD shows  and, if the device is off, displays a message “Charging... xx% complete.”

When the device is charged, the LCD shows:

-  (if the device is on)
-  and the message “Fully charged” (if the device is off).

Charging Through a Computer

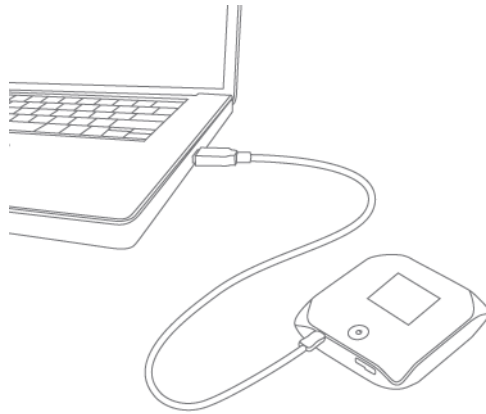

Note: Charging through a computer usually takes longer than charging through the AC charger.

Note: If you'll be using USB for data transfer (and not just for charging the device), you must install the device driver. See "Making a Tethered Connection" on page 27.

Note: If you're using Mac OS X 10.4.x, after you connect the device you may see a warning message that your computer is running on UPS backup battery and that you should perform a computer shutdown. You can continue with your work. To prevent this message from being displayed, install the device driver. See "Making a Tethered Connection" on page 27.

1. Ensure the computer is turned on.
2. Insert the larger (USB) end of the USB to Micro B cable into the computer.
3. Insert the other (Micro B) end of the USB to Micro B cable into the USB connector on the side of the device.

When charging, the LCD shows the animated icon .

When the device is charged, the LCD shows .

Power Button

Turning Your Device On and Off

Turning Your Device On

1. Ensure that:
 - The device has a charged battery inserted.
 - or —
 - The device is connected to the AC charger or a computer (through the USB to Micro B cable), as shown in the drawing on page 11.

2. If the device LCD is blank, press and hold the power button  for two seconds.

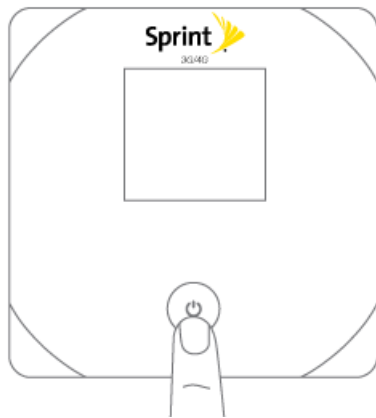



Turning Your Device Off

- Press and hold the power button  for 2 seconds.

Using the Power Button to Determine the Device State

The power button  on the device also indicates the device's status, as shown in the following table.

Power button 	Description	Your action
Not lit	The device is turned off, and may or may not be charging.	To turn the device on, press and hold the power button  for two seconds.
	The device is turned on, but you have turned off the LED.	[OPTIONAL]: Turn on the LED. See "Enabling and Disabling the LED" on page 70.
Lit, flashing (approximately every 4 seconds)	The device is turned on, and the LED is enabled.	No action required.
Lit, flashing (approximately every 30 seconds)	The device is in standby (low power) mode. The following are off: LCD, Wi-Fi radio, 3G/4G radios. For more information, see "Standby (Low Power) Mode" on page 46.	To exit standby mode: Connect the device to the AC charger or computer, through the USB to Micro B cable. — or — Press the power button  .

Controlling the Device Using the Power Button

Type of press	Result
Quick press	<ul style="list-style-type: none">● Removes device from standby (low power) mode.● Wakes up (turns on) the LCD if the LCD was enabled but dormant. (The LCD turns dark, after a configurable time of inactivity.)● Confirms or acknowledges a displayed message.● Turns off display of the Wi-Fi network name and password.
Quick double-press	<ul style="list-style-type: none">● Wakes up (turns on) the LCD if the LCD was enabled but dormant. (The LCD turns dark, after a configurable time of inactivity.)● Briefly displays the Wi-Fi network name and password. (See “Wi-Fi Password Reminder” on page 86.)
Long press (press and hold for two seconds)	Turns the device on or off.

LCD

If the LCD is not lit, see “Turning Your Device On” on page 13.

Interpreting the LCD

The LCD shows icons and text that reflect the status of the device and your connection.

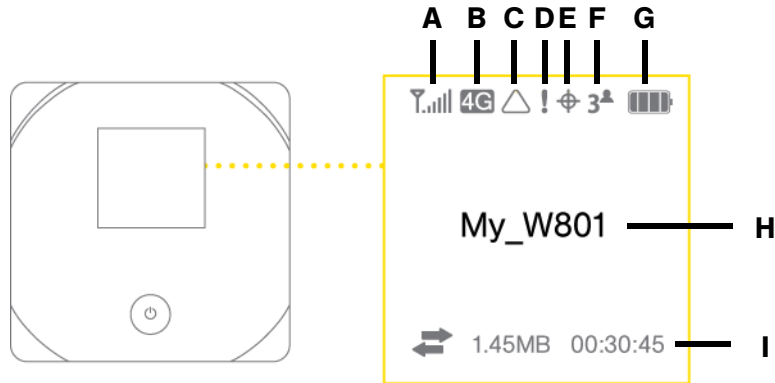

A	Signal strength
B	3G/4G status
C	Roaming indicator
D	Alerts
E	GPS
F	Number of Wi-Fi users
G	Battery status
H	Device name. Message area.
I	Amount of data transferred; connection duration. Message area.

Tip: Most of the LCD icons and messages are also shown on the Virtual Device and Mini Window. (See “Virtual Device” on page 32 and “Mini Window” on page 32, and “Messages Displayed on the Device LCD” on page 125.)

Mute Switch

The mute switch is used to turn on or off sounds from the device. The mute switch is located on the side of the device:



Tip: You can also disable sounds through the home page. See “Sounds Information and Settings” on page 48.

microSD Card Slot

Your device supports a microSD™ card (sold separately) for file sharing and transfer or storage. The microSD slot is located on the same side of the device as the USB connector. Your computer recognizes the microSD card as a removable storage device. The device supports microSD cards up to 16 GB.

Note: Using microSD cards larger than 16 GB can cause data loss and damage your device.

Section 3

Setting up the Device



Section 3A

Setting Up Your Device

- ◆ **Setting Up Your Device on Your Account (page 20)**
- ◆ **Setting Up the Device (page 20)**

Setting Up Your Device on Your Account

Normally your device will be set up on your Sprint account at the time of purchase.

To verify that your device is set up on your Sprint account:

1. Log in to your account at www.sprint.com by entering your username and password.
2. Confirm that the Overdrive 3G/4G Mobile Hotspot is on your account with a Mobile Broadband connection plan.

If you don't see your device listed, you will need to contact Sprint Customer Service to complete setting up the device on your account. (See "Contacting Customer Service" on page 114.) Have the following available before calling:

- Your Sprint account information.
- The ESN number of your device (displayed on the packaging, on the device [under the battery], and at **Advanced settings > Device > About**).

Setting Up the Device

1. Install the battery, as described in "Installing the Battery" on page 9.
2. Connect the device to the AC charger, as described in "Using the AC Charger with USB Port" on page 12.
3. Plug the AC charger into an electrical outlet.
4. **Important:** Charge the device until the battery icon is full (.

Connecting to the Network

1. Ensure you are in the Sprint 3G or 4G coverage area (not roaming).
2. If you have a LAN connection, disconnect it.
3. Ensure your computer's Wi-Fi is turned on.

4. If the device LCD displays “Charging”, “Charged”, or “Powered off,” press and hold the power button  for two seconds.

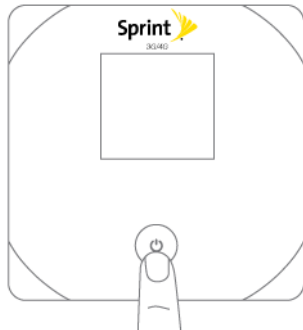

5. Wait until the device LCD displays “Connect your computer to Wi-Fi network,” followed by the network name (SSID) and password. This may take several seconds.
6. On your computer, connect to the Wi-Fi network listed on the device LCD. If you don’t know how to do this, see “How Do I Connect to Wi-Fi?” on page 116. After you’ve connected to the Wi-Fi network, the device LCD displays “Open any web page to continue setup.”
7. Open your Web browser. The “Welcome to your Overdrive” window opens.

Note: This window displays the administrator password and the address of the device home page. Please remember this information or write it down in a safe place.

This window provides several options.

- To keep the default settings of the device, click one of the following:
 - **The Internet** (to start surfing)
 - **My Overdrive’s home page** (to view the device status, customize settings). Proceed to “Activating and Using Your Network Service” on page 24.
- To change security settings, click **Set up my Overdrive**.

Changing the Password and Settings

During the device setup, you can select **Set up my Overdrive** to change the settings for the:

- **Administrator password** – This password is used to log in to the home page, where you can view and customize your device settings. The default password is “password.” Choose something easy-to-remember (yet not easily guessed by others). If you forget this password, you’ll need to reset the device to its default settings and go through the device setup (as described in “Setting Up the Device” on page 20).

Your administrator password must be 1–20 characters long.

- **Wi-Fi network name (SSID)** – This name is visible to other Wi-Fi-enabled devices, and is used to identify your Wi-Fi network. The length of the Wi-Fi network name (SSID) depends on other settings of the browser interface. (See the Help bubble that’s displayed when you move the cursor to the SSID input field.)

- **Wi-Fi security** – The default setting is WPA. To select another option, click **More options**. See “Wi-Fi Security Options” on page 22.
- **Wi-Fi password** – The maximum length of this field is determined by the Wi-Fi security option (the previous item). (See the Help bubble that’s displayed when you move the cursor to the Wi-Fi password field.)

If you’ll be sharing your Internet connection with others, you’ll have to give the Wi-Fi password to others; don’t use your banking or other important passwords. Also, don’t use a password that’s easily guessed by others.

From this window you can also enable the Password Reminder feature, which is useful if you forget the Wi-Fi password. See “Wi-Fi Password Reminder” on page 86.

Tip: Help information on each field appears (in a bubble) when you move the cursor into the field. You can display this window any time, by clicking **Admin Setup** () in the browser interface.

After you change the settings and click **Submit**, the device restarts and displays updated information on its LCD. Follow the instructions on the LCD, and proceed to “Your Device is Now Restarting” on page 24.

Wi-Fi Security Options

If you click **More options** (after having clicked **Set up my Overdrive**, during the device setup), a window with four Wi-Fi security options opens.

Note: All the devices used with the Overdrive 3G/4G Mobile Hotspot must support the selected security type.

Going from no security to stronger security, the options are:

- **None** – No security (no password is required to access the Wi-Fi network); not recommended. Anyone may access your device and use your Internet connection (you are responsible for payment for data usage).
- **WEP-64 Bit** – Lower security. Works with older and newer Wi-Fi devices. Recommended only if any of your devices don’t support WPA or WPA2.
- **WPA-Personal** – A strong security standard, supported by most Wi-Fi devices.
- **WPA2-Personal** – A stronger, newer security standard. Limited to newer Wi-Fi devices.

If the above options don’t meet your requirements, click **I don’t see what I want....**

Expanded Wi-Fi Security Options

If you display the **Security** panel of the **Wi-Fi** tab of the **Advanced Settings** window or if you click **I don't see what I want...** (from the Wi-Fi Security Options window during the device setup), a window with an expanded list of Wi-Fi security options opens.

Note: All the devices used with the Overdrive 3G/4G Mobile Hotspot must support the selected security type.

The options are:

- **None** – No security (no password is required to access the Wi-Fi network); not recommended. Anyone may access your device and use your Internet connection (you are responsible for payment for data usage).
- **WEP 64 Bit - Shared** – Lower security. Works with older and newer Wi-Fi devices. Recommended only if any of your devices don't support WPA or WPA2.
Shared WEP uses the same key for encryption and authentication; some consider shared WEP to be less secure than open WEP.
- **WEP 128 Bit - Shared** – Lower security. Works with older and newer Wi-Fi devices. Recommended only if any of your devices don't support WPA or WPA2.
Shared WEP uses the same key for encryption and authentication; some consider shared WEP to be less secure than open WEP.
- **WEP 64 Bit - Open** – Lower security. Works with older and newer Wi-Fi devices. Recommended only if any of your devices don't support WPA or WPA2.
Open WEP uses the key for encryption, but not for authentication.
- **WEP 128 Bit - Open** – Lower security. Works with older and newer Wi-Fi devices. Recommended only if any of your devices don't support WPA or WPA2.
Open WEP uses the key for encryption, but not for authentication.
- **WPA Personal - TKIP** – A strong security standard, supported by most Wi-Fi devices.
- **WPA Personal - TKIP/AES** – A strong security standard, supported by most Wi-Fi devices.
- **WPA2 Personal - AES** – A stronger, newer security standard. Limited to newer Wi-Fi devices.
- **WPA2 Personal - TKIP/AES** – A stronger, newer security standard. Limited to newer Wi-Fi devices.
- **WPA/WPA2 Personal** (recommended setting) – Wi-Fi devices that use either WPA or WPA2 can connect to the Overdrive 3G/4G Mobile Hotspot. Supported by most Wi-Fi devices.

Your Device is Now Restarting

The “Your device is now restarting” window opens if you’ve clicked **Set up my Overdrive** and then clicked **Submit**.

The changes take effect after the device restarts automatically.

It’s recommended you write down the following information that’s displayed in the window:

- Wi-Fi network name
- Wi-Fi password

As described in the window,

1. Wait until the device LCD displays “Connect your computer to Wi-Fi Network.”
2. Connect your computer to the Wi-Fi network, using the information you’ve written down. (If you don’t know how to do this, see “How Do I Connect to Wi-Fi?” on page 116.)
3. After the Wi-Fi connection was successfully established, click the **Click here** text in the window.

Activating and Using Your Network Service

Note: If you’re able to connect to 3G, you are already set up to use Sprint service on the 3G network; no further action is needed. Proceed to “Using Your Device” on page 25.

Before using your device, you must have a Sprint wireless network account set up. The process of setting up an account is called **activation**. When the device starts up, it will detect whether the device has been configured with an account (“preactivated”). If it has not, the activation process starts automatically.

In most cases, the activation process will be seamless, not requiring any action from your part; in some cases, you won’t even see any activation-related messages displayed on the device LCD.



Initiating Activation of Your Device for 3G

In rare cases, the device LCD and the home page may indicate that activation is required:

- The LCD displays “3G Activation failed.”
- The home page displays the alert “3G Activation Required.”

Note: You will still be able to connect to the Internet, when you have 4G coverage.

To activate your device for 3G:

1. In the **Admin Login** section (in the upper left area of the home page), enter the administrator password (1–20 characters/numbers). (The default password is "password".)
2. Click **OK**.
3. Click the alerts icon  to display the alert window.
4. If more than one alert is available, use the  and  buttons (at the top of the alert window) to browse to the “3G Activation Required” alert.
5. In the alert, click **Activate now**.

If the activation fails, contact Sprint. See “Contacting Customer Service” on page 114.

Section 4

Using Your Device



Section 4A

Connecting Through USB

- TRU-Install (page 26)
- Requirements for a USB Tethered Connection (page 26)
- Making a Tethered Connection (page 27)

TRU-Install

TRU-Install™ is a Sierra Wireless feature that installs the necessary drivers the first time you connect the device to your Windows or Mac computer through the USB to Micro B cable. (For details, see “Making a Tethered Connection” on page 27.) An installation CD is not required.

By default, TRU-Install is enabled.

To change the setting:

1. Ensure you're logged in to the home page.
2. Click **Advanced settings > Device > Basic**.
3. Select a value for **TRU-Install**.

Requirements for a USB Tethered Connection

Your device supports a direct connection through a USB cable to a Windows or Mac computer. (This is commonly referred to as a “tethered” connection.)

Making a Tethered Connection

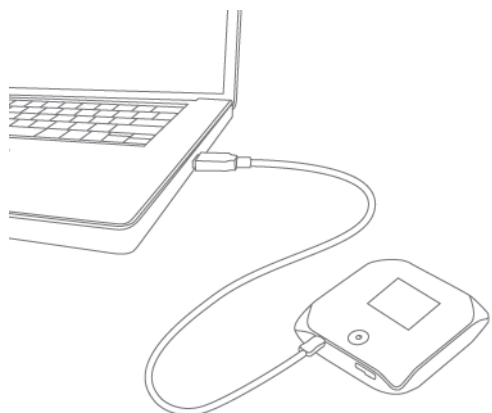

Note: If you'll be using USB for data transfer (and not just for charging the device), you must install the device driver (see below). No installation CD is required – the device supports the Sierra Wireless TRU-Install feature.

Note: If you're using Mac OS X 10.4.x, after you connect the device you may see a warning message that your computer is running on UPS backup battery and that you should perform a computer shutdown. You can continue with your work. To prevent this message from being displayed, install the device driver (see "Mac" on page 28).

Windows

To install the device driver on Windows:

1. Ensure the device is turned on.
2. Connect the device to your computer through the USB to Micro B cable.
3. If the TRU-Install window is not displayed, in Windows Explorer browse to the  TRU-Install entry (under My Computer), then browse to the Win folder and run **Setup.exe**.

– or –

If you're running Windows Vista and the AutoPlay window opens, click **Run setup.exe**.

4. In the TRU-Install window, click **OK**.
5. Go through the installation of the Sierra Wireless USB driver. (Follow the instructions on the screen.)

– or –

1. Using Wi-Fi, connect to the device. See "How Do I Connect to Wi-Fi?" on page 116.
2. Ensure you're logged in to the home page.
3. Click **Advanced settings > Device > Basic**.
4. In the TRU-Install section, click **Windows**, to download the .exe file to your computer.

5. Run the **.exe** file, and go through the installation of the Sierra Wireless USB driver. (Follow the instructions on the screen.)

Mac

To install the device driver on Mac:

1. Ensure the device is turned on.
2. Connect the device to your computer through the USB to Micro B cable.
3. In the window that appears, double-click the **.pkg** file.
4. Go through the installation of the Sierra Wireless USB driver. (Follow the instructions on the screen.)
5. When prompted for your password, enter your Mac password.

– or –

1. Using Wi-Fi, connect to the device. See “How Do I Connect to Wi-Fi?” on page 116.
2. Ensure you’re logged in to the home page.
3. Click **Advanced settings > Device > Basic**.
4. In the TRU-Install section, click **Mac OS X**, to download the file to your computer.
5. If the “Welcome to the Sierra Wireless Driver Installer” window isn’t automatically displayed, double-click the file that you’ve downloaded.
6. In the “Welcome to the Sierra Wireless Driver Installer” window, click **Continue**.
7. Follow the instructions on the screen.

Connecting the Device to Your Computer

1. Insert the larger (USB) end of the USB to Micro B cable into your computer.
2. Insert the other (Micro B) end of the USB to Micro B cable into the USB connector on the side of the device.

Section 4B

Browser Interface Home Page

- ◆ **Displaying the Home Page of the Device (page 31)**
- ◆ **Logging On as an Administrator (page 31)**
- ◆ **Virtual Device (page 32)**
- ◆ **Mini Window (page 32)**
- ◆ **Turning Your Device Off (page 33)**

The home page is the entry page of the browser interface that lets you:

- Display status information for your device and your data connection.
- Launch and end a network connection.
- Change the settings for your device and your data connections (if you're logged in).
- Access additional resources (the user guide and the Important Information document).

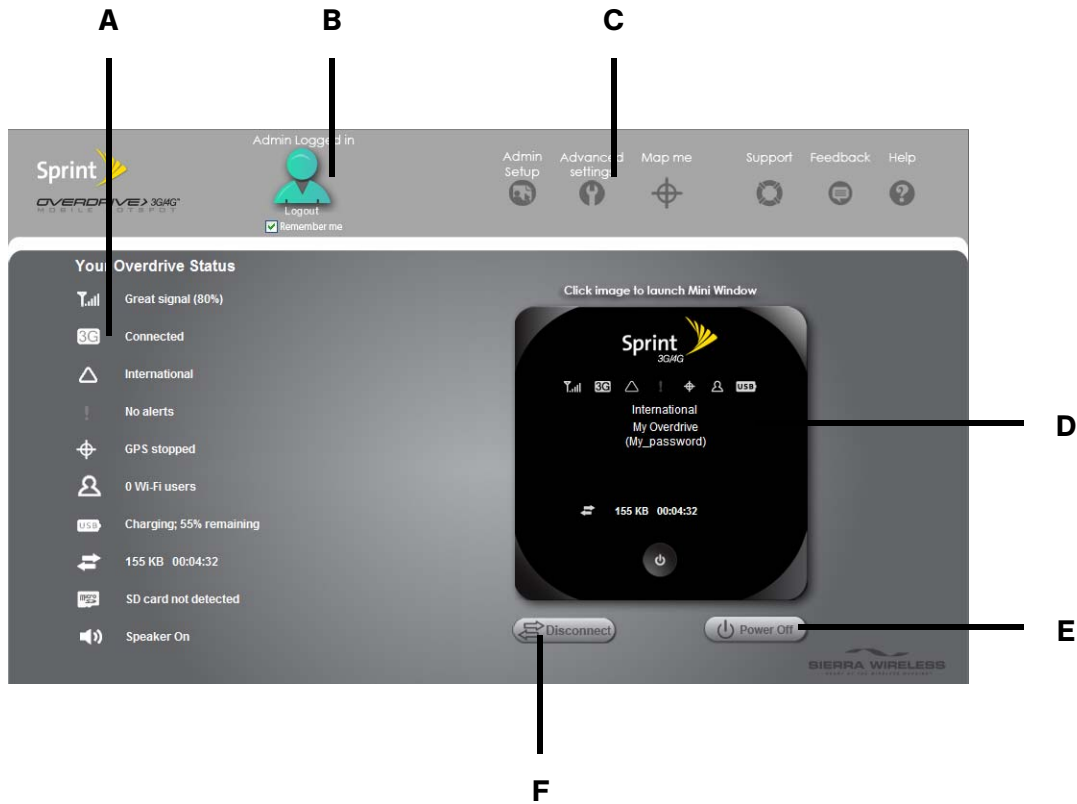

A	<p>When you click an icon or the text next to it, a window opens to the right (see the screenshot on page 41). The window contains additional status information and, if you're logged in, commonly-used configurable settings. See "Vertical Row (of Icons and Text)" on page 40.</p>
B	<p>Use this area to enter the administrator password and log in. When you're logged in, you can change settings. See "Logging On as an Administrator" on page 31.</p>
C	<p>Clicking one of these buttons displays a window or a menu. See "Home Page Buttons" on page 49.</p>
D	<p>This is the Virtual Device; it reflects the status of your device. If you click the image, a movable Mini Window is opened. See "Virtual Device" on page 32 and "Mini Window" on page 32.</p>
E	<p>A handy way to turn the device off, especially if, for example, you're in an airplane before takeoff, and the device is in your overhead bag. Available only if you're logged in.</p>
F	<p>Disconnects a connection, or connects (if currently there's no connection). Available only if you're logged in.</p>

Displaying the Home Page of the Device

Note: You can display the home page only when your device is turned on and you have established a connection to it (through Wi-Fi or through the USB to Micro B cable).

To display the home page, type one of the following in the address bar of your Web browser:

- **http://Overdrive**
- **SSID** value (field in **Advanced settings > Wi-Fi > Network** and also in **Advanced settings > Router > LAN**)

Note: If you're using the Google Chrome Web browser, after typing in the address bar, press the Down Arrow key and then the Enter key. (If you press only the Enter key, a Google search is started, using the information you typed in.)

If your Web browser displays an error message, see “Cannot Display the Home Page” on page 127.

Logging On as an Administrator

You don't need to log in to access and use the home page. However, when you're logged in:

- Additional information appears in the window that opens when you click an item on the left side of the home page. See “Vertical Row (of Icons and Text)” on page 40.
- You can access the **Advanced Settings** window, where you can modify additional settings.
- You can rerun the device setup, if required (**Admin Setup** ).
- You can install updates.

To log in:

1. Ensure that nobody else is already logged in – other people can use the home page at the same time, but only one user can be logged in.
2. In the **Admin Login** section (in the upper left area of the home page), enter the administrator password (1–20 characters/numbers). (The default password is “password”. It's recommended you change the password, if you haven't already.)
3. Click **OK**.

After a certain time, you will be automatically logged off (timeout security feature), unless you select **Remember me** (below the password field). For more information, see “Automatic Login (“Remember Me”)” on page 73.

Virtual Device

The right half of the home page contains an image of your device.

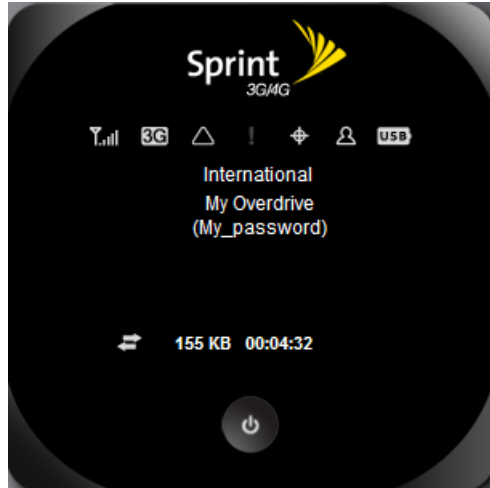

This is a “virtual device” – it reflects most of the icons and text displayed on the real device.

Mini Window

If you click the virtual device in the home page, the Mini Window opens – an image of the device in a separate Web browser window.

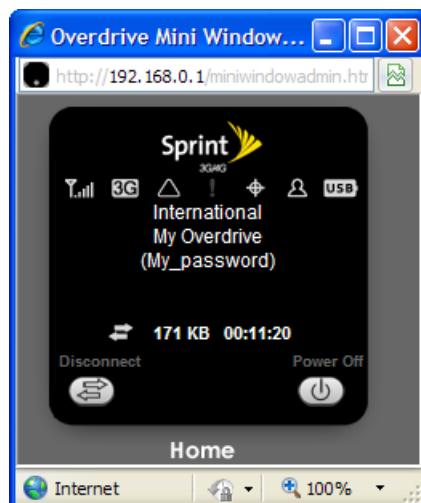

Similar to the virtual device, the Mini Window reflects most of the icons and text displayed on the real device.

To save space on your monitor, you can close the home page and move the Mini Window to the side of your monitor. Then you can use the window to keep an eye on the status of your device and connection. (To reopen the home page, click the **Home** link.)

If you're logged in, the window has a **Connect** or **Disconnect** button, and a **Power Off** button.

Turning Your Device Off

- From the home page:
 1. Ensure you're logged in to the home page.
 2. Click **Power Off** (below the Virtual Device).
- From the Mini Window:
 1. Ensure you're logged in to the home page.
 2. Click **Power Off**.

Tip: You can also turn the device off by pressing and holding the power button  for 2 seconds.

Section 4C



Alerts

- ◆ 3G Activation Required (page 34)
- ◆ 3G Network Update Available (page 35)
- ◆ GPS Privacy Agreement (page 35)
- ◆ SD Card Error (page 36)
- ◆ Software Update Available (page 36)

The alerts icon  indicates whether there are any alerts (messages that require your attention).

The icon is on the left side of the home page.

Click the icon to display the Alert window. If more than one alert is available:



- The higher priority alert opens.
- When you close an alert, the next alert opens.
- You can use the  and  buttons (at the top of the alert window) to view other alerts.

The options and instructions shown in the alert window depend on the alert event. Please read the instructions carefully. They may state, for example, that you have to reconnect to Wi-Fi after an update is installed.

3G Activation Required

If only 3G coverage is available, you won't be able to connect to the Internet until 3G activation has been completed.

To activate 3G on your device:

1. Ensure you have 3G coverage.
 2. Ensure you're logged in to the home page.
 3. Click the alerts icon  to display the alert window.
 4. If more than one alert is available, use the  and  buttons (at the top of the alert window) to browse to the alert.
 5. In the 3G Activation Required alert window, click **Activate now**. (Activation is then performed over the network; no user interaction is required.)
- If activation is successful, "Activation complete!" is displayed. You can now connect to the 3G network. If the connection is not established automatically, click **Connect** on the home page or Mini Window.

- If activation was not successful, “Activation failed” is displayed. Retry the activation. If it is not successful, prepare the following, and contact Sprint:
 - Your billing information.
 - ESN of the device (displayed on the packaging, on the device [under the battery], and at **Advanced settings > Device > About**).



3G Network Update Available

The 3G Network Update Available alert appears if a PRL update or 3G profile update is available for your device. The update may improve your 3G network service.

Note: During installation of the update:

- DO NOT turn off or unplug the device.
- Your 3G connection won't be available. (Your 4G connection won't be affected.)

To install the update:

1. Ensure you have 3G coverage.
2. Ensure you're logged in to the home page.
3. Click the alerts icon  to display the alert window.
4. If more than one alert is available, use the  and  buttons (at the top of the alert window) to browse to the alert.
5. In the 3G Network Update Available alert window, click **Update now**.

GPS Privacy Agreement

The GPS Privacy Agreement alert appears if you haven't accepted the GPS privacy agreement. (You cannot use GPS until you accept the GPS privacy agreement and then enable GPS.)

To accept the GPS privacy agreement:

1. Ensure you're logged in to the home page.
2. In the vertical row of icons (down the left side of the home page), click the GPS icon () and, in the window that's displayed, click **View privacy agreement**.

– or –

Display the GPS Privacy Agreement alert window. See “Alert Information” on page 43.

3. Read the agreement, and select **I accept**.

SD Card Error

If you're having problems reading from the microSD card, or if the SD Card Error alert window opens or the device LCD displays "SD Card error," try the following:

1. Remove and reinsert the microSD card.
2. If the card is still not working, try it in the microSD slot of another computer.
If it works in the other device, the card slot on your device may have a problem.

If the card doesn't work in the other computer, try one of the following:

- Use a different microSD card.
– or –
- Reformat your card.

Note: The formatting procedure erases all the data on the microSD card, after which the files CANNOT be retrieved. To prevent the loss of important data, please check the contents before you format the microSD card.

Software Update Available



The update may improve performance and add or modify features.

Note: During installation of the update, your Internet and Wi-Fi connections won't be available. When the installation is complete, you will need to reconnect to Wi-Fi.

To install the update:

1. Ensure your device is connected to the AC charger or computer, through the USB to Micro B cable.

Note: If you'll be using USB for data transfer (and not just for charging the device), you must install the device driver. See "Making a Tethered Connection" on page 27.

2. Ensure you're logged in to the home page.
3. Click the alerts icon  to display the alert window.
4. If more than one alert is available, use the  and  buttons (at the top of the alert window) to browse to the alert.
5. In the Software Update Available alert window, click **Update Options**.
6. Read the information in the Software Installation Options window.

7. To install the update, click **Download and install now**.

– or –

If you are not in a strong signal area, make a note of the URL displayed in the window and click **I'll get the update later**. At a later time, access the URL to download the update to your computer, and then follow the steps in “Upgrading Firmware From a File” on page 60.

When the installation is complete, reconnect to Wi-Fi. See “How Do I Connect to Wi-Fi?” on page 116.

Section 4D

Your Network Connection

- ◆ [Launching Your Network Connection \(page 38\)](#)
- ◆ [Sharing Your Connection \(page 38\)](#)
- ◆ [Ending Your Network Connection \(page 39\)](#)

Launching Your Network Connection

After the device powers on and boots up, a connection to the 3G/4G network is launched automatically, unless you've disabled **Connect Automatically**.

You will need to manually launch a connection if:

- The connection was not successful.
- You've disabled auto-connect.
- You've manually ended a connection (by clicking **Disconnect**).

To launch a connection:

▶ Click **Connect** on the Virtual Device on the home page. (You must be logged in.)

– or –

Click **Connect** in the Mini Window. (You must be logged in.)

– or –

If the device LCD displays "Disconnected from 3G/4G network. Connect now?", press the power button  on the device.

See also:

- "Internet Connection Information" on page 47.
- "Mobile Broadband Information and Settings" on page 42.
- "3G Roaming Information and Settings" on page 43.
- "Signal Information" on page 41.

Sharing Your Connection

For others to share your network connection:

1. Provide the Wi-Fi network name and password to them.
2. On their computer, users must connect to the Wi-Fi network of the Overdrive 3G/4G Mobile Hotspot. See "How Do I Connect to Wi-Fi?" on page 116.

Ending Your Network Connection

1. Ensure you're logged in to the home page.
2. Click **Disconnect** on the Virtual Device or in the Mini Window. See "Virtual Device" on page 32 and "Mini Window" on page 32.

Note: The Wi-Fi connection is still available, so users can, for example, share files by using a microSD card.

Section 4E

Vertical Row (of Icons and Text)

- ◆ Signal Information (page 41)
- ◆ Mobile Broadband Information and Settings (page 42)
- ◆ 3G Roaming Information and Settings (page 43)
- ◆ Alert Information (page 43)
- ◆ GPS Information and Settings (page 44)
- ◆ Wi-Fi Users Information and Settings (page 45)
- ◆ Battery Information and Settings (page 46)
- ◆ Internet Connection Information (page 47)
- ◆ microSD Card Information and Settings (page 47)
- ◆ Sounds Information and Settings (page 48)

The left part of the home page has a vertical row of icons and text, starting with the signal strength indicator .

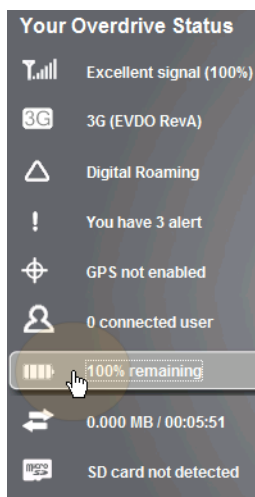

Most of these icons are also shown on the physical device and Virtual Device (page 32). Hover the mouse over an icon; the corresponding icon on the Virtual Device is highlighted.

If you click an icon or the text, a window opens with additional information, as shown in the following screenshot.

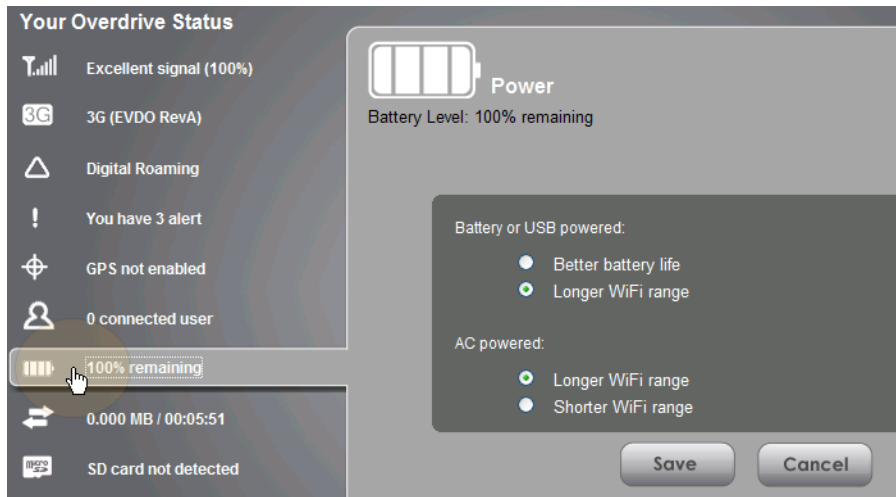

If you're logged in, the window may also display configurable settings.

Note: A more complete set of configurable settings is available in the **Advanced Settings** window. See "Advanced Settings" on page 49.

Signal Information



No signal



Very weak signal

...

The number of bars reflects the signal strength: the more bars, the stronger the signal.



Excellent signal

Click the signal strength icon to display the Signal Quality window. The window displays:

- The active network: the network that is currently being used for your data connection. For example: "3G (EVDO Rev A)."
- 3G or 4G status:
 - Connection status. For example: "Connected."
 - Brief description of the signal strength. For example: "Good signal (60%)."
 - Tables that show the coverage type, RSSI, and Ec/Io (for 3G) or CINR (for 4G).

RSSI reflects the signal strength of the network.

Ec/Io is a dimensionless ratio of the average power of a channel, typically the pilot channel, to the total signal power.

CINR stands for Carrier to Interference-plus-Noise Ratio, and is a measurement of signal effectiveness.

The first table also shows the type(s) of 3G service you have: 1X, 1xEV-DO, or both. (To determine whether you have EV-DO Rev. 0 or Rev. A service, use the text near the 3G icon; see “Mobile Broadband Information and Settings” on page 42.)

See also “Improving Signal Strength” on page 120.

Mobile Broadband Information and Settings

The 3G or 4G icon indicates the service and connection state. Note that only one icon is shown (the active network).

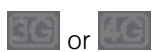

You have no service. Try the suggestions in “Cannot Connect to the 3G/4G Network” on page 129.

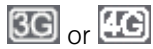

You have service but are not connected.



You have service and are connected.

The text next to the icon displays the connection status, for example: “No service”, or “3G (EVDO Rev A).”

Click the icon to display the Mobile Broadband Information window. The window displays:

- The active network: the network that is currently being used for your data connection. For example: “4G” or “3G (EVDO Rev A).”
- 3G and 4G status:
 - Connection status. For example: “Connected.”
 - Brief description of the signal strength. For example: “Good signal (60%).”
- Connection Preferences (if you’re logged in).

Configuring the 3G/4G Connection Preferences

The value determines which network(s) to connect to, and in what order:



- **4G Preferred** – Connection can be established to either 3G or 4G; if both are available, 4G is used. This setting is recommended if your service provider has no data limit for 4G, but does for 3G, or you want to take advantage of the faster data transfer speeds of 4G.
- **3G Preferred** – Connection can be established to either 3G or 4G; if both are available, 3G is used.
- **4G Only** – Connection can be established only to 4G.
- **3G Only** – Connection can be established only to 3G.

If you don’t have 4G coverage, you can save power by selecting “3G Only.”

To automatically connect to the network upon loss of connection or when the device powers on, select **Connect Automatically**.

3G Roaming Information and Settings

The roaming indicator shows whether you are roaming. The text near the icon may indicate additional details.

-  Not roaming
-  Roaming
-  [flashing] Enhanced roaming indicator

Note: Roaming on 4G is not supported.

Click the roaming indicator to display the 3G Roaming Information window. The window displays:



- Roaming status.
- **Allow 3G roaming** field (if you're logged in).
 - If you select this field, you can roam and connect when outside of Sprint coverage, but additional charges may occur. (To roam outside of North America, you must also select **Allow international access**.)
 - If you do not select this field, you can connect only when you're inside the Sprint coverage area.
- **Allow international access** field (if you're logged in, and subject to feature availability) – allows roaming outside of North America.

If this field is displayed but not available, select **Allow 3G roaming**.

Alert Information

The alerts icon indicates whether there are any alerts (situations that require your attention).

Note: To view alert information, you must be logged in. New alerts are checked upon device power-up. That is, if an event occurs, you won't be notified until the device is restarted.

-  No alerts are available.
-  One or more alert is available.

The text next to the icon indicates the number of alerts.

Click the icon to display the Alert window.

For more information, see "Alerts" on page 34.

GPS Information and Settings



GPS is off (not enabled).

Before you can use GPS, you must accept the GPS privacy agreement and enable GPS. See “GPS Privacy Agreement” on page 35 and “Enabling GPS” on page 56.



GPS is on and available. (The GPS privacy agreement has been accepted, and GPS is enabled.)



(flashing)

GPS is active (acquiring a location fix).

The text next to the icon displays the GPS status, for example: “GPS not enabled” or “GPS searching for satellites.”

Click the icon to display the GPS Information and Settings window. The window shows the GPS status and, if available, location information, including:

- **Timestamp** – indicates the time of the last fix.
- **HEPE** – Horizontal Estimated Position Error; it reflects accuracy (horizontal/vertical precision).

Note: For best results, minimize the number of obstructions between your device and the GPS satellites.

Configuring the Settings

When you're logged in, the following settings are available.

View privacy agreement (link displayed if you haven't yet accepted the GPS privacy agreement). You cannot enable and use GPS until you accept this agreement. Click the link to view and then accept the agreement.

Enable GPS – To use GPS and to configure other GPS settings, this check box must be selected.

GPS Mode – How often the device should obtain a fix.

- **One-time** – Use a single fix. Use this option if you'll be using your device at the same location.
- **Continuous** – Obtain fixes on a regular basis. Also known as auto-tracking. Useful for navigation or turn-by-turn (TBT) applications (for example, driving directions).

Get fix now – This button starts a one-time fix (not displayed if **GPS Mode** [above] is **Continuous** or a GPS session is already in progress). If you change the value from **Continuous** to **One-time**, you must click **Save** before your changes take effect and the fix becomes possible.

Mapping service – The mapping service (for example, Google Maps or MapQuest) that displays the GPS results (in a separate browser window).

Metric units – Specifies whether to use metric when displaying the GPS results (for example, the altitude, speed, HEPE).

Note: Additional settings are available at **Advanced settings > WAN > GPS**. See “GPS Settings” on page 93.

Wi-Fi Users Information and Settings

The Wi-Fi users icon shows how many Wi-Fi users are connected to the device.



No Wi-Fi users are connected. (One user is connected via USB).



One user is connected via Wi-Fi.





The number indicates how many Wi-Fi users are connected.

Click the icon to display the Connected Users window.

Connected Users Information

When you're logged in, the Connected Users window shows a table with information on computers currently connected to the device.

A row may optionally show one or both of these icons:

-  – The user of this computer is logged in as administrator.
-  – This computer is connected to the device through the USB to Micro B cable.

MAC Address – Each wireless device has a unique MAC address (assigned by its manufacturer). On Windows PCs, the MAC address is called the “physical address”; on a Mac computer, it is called the “Ethernet ID.” See “Finding the MAC Address” on page 122.

Block – Used to block the computer's access to the device. You might want to do this if:

- You don't recognize a listed computer.
- You have lots of data to transfer (you want to be the sole user of the bandwidth).
- You're approaching the data limit on your account.

Note: You cannot block the administrator. (The row for the administrator has the  icon.)

Max Wi-Fi users – Limits the number of Wi-Fi users that can connect to the device. A smaller number improves performance and security.







Disable Wi-Fi when connected via USB – Turns off the Wi-Fi of the device when it is connected to a computer through the USB to Micro B cable. Only this computer will be able to use the device.

Battery Information and Settings

The battery icon indicates the state of the battery of the device.

The text next to the icon displays additional information, for example, the charging status (% remaining or % complete).

Tip: You can also check the battery icon from the Home page, Mini Window, and device LCD.

	Battery level is critical. Charge the device immediately. See “Charging the Device” on page 11.
	No battery; connected to an electrical outlet (through the AC charger).
	Connected to USB. Battery is either charging, or is not inserted.
	Charging through the AC charger.
	Battery is low. Charge the device. See “Charging the Device” on page 11.
...	The more bars are shown, the more the battery is charged.
	Battery is charged.

Click the icon to display the Battery Information and Settings window.

When you're logged in, you can set the behavior for when the device is:

- **Battery or USB powered.** Choose one of the following:
 - **Better battery life** – At the cost of shorter Wi-Fi range.
 - **Longer Wi-Fi range** – At the cost of shorter battery life.
- **AC powered.** Choose one of the following:
 - **Longer Wi-Fi range**
 - **Shorter Wi-Fi range** – You have a designated wireless area and you need to minimize the effect of your network on other networks in the vicinity.

Standby (Low Power) Mode

When the device is in standby (low power) mode, the 3G/4G modem radios, the Wi-Fi radio, and the LCD are off, and the power button  is flashing.

When you're logged in, you can set how soon the device goes into standby mode when no Wi-Fi users are connected to it (**Standby Timer**).

You can specify different settings for battery power and AC power.

Note: This setting has no effect when the device is connected to a computer through the USB to Micro B cable.

To exit standby mode:

- ▶ Connect the device to the AC charger or computer, through the USB to Micro B cable.
 - or –
- Press the power button .

Internet Connection Information

Note: Data usage amounts are approximate and should not be used for billing purposes. For accurate data usage amounts, check with Sprint.

Click the data icon  to display the Internet Connection Information window. The window displays:

- Data statistics for the current connection session:
 - Data sent
 - Data received
 - Total transferred
 - Session duration
- The WWAN IP address of the device – the external IP address of the modem [3G or 4G] (that is, the IP address of the modem as seen from the Internet).

Viewing and Configuring Detailed Internet Connection Information

When you're logged in, the Internet Connection Information window displays a table showing data use:

- In the currently billing cycle. These numbers get automatically reset to 0 on the day selected in the **Starts on day** list.
- Over the lifetime of the device.
- By network [3G/4G], and by sent/received/total.

From this window you can:

- Reset the data usage figures for the current billing cycle. (Click **Reset**.)
- Change the start day of the billing cycle (in the **Starts on day** list).

microSD Card Information and Settings

The text next to the microSD icon () indicates whether the card is:

- Enabled
- Detected
- Accessible by all (“shared”) or only the administrator
- Accessible with or without a password (security)

Click the icon to display the SD Card Information and Settings window. The window displays:

- The card status (see the list on the previous page)
- Storage capacity of the card, and space available

When you're logged in, you can:

- Enable or disable the microSD card slot. See "Enabling the microSD Card Slot" on page 52.
- Set up access to the card. See "Setting Up Access to the microSD Card" on page 52.

Sounds Information and Settings

The sounds icon () shows whether the device speaker is on.



The device speaker is on.



The device speaker is off.

Click the sounds icon to display the Sounds window. The window displays:

- Status of the device speaker (on or off).
- If you're logged in: check boxes to enable or disable sounds for the following events:
 - **Internet connected**
 - **Internet disconnected**
 - **Low battery** – Useful as a reminder to charge the device.
 - **System alerts** – When you hear the device beep, you can then use the device LCD or the Alerts window to get information about the alert. See "Alert Information" on page 43.

Note: System alerts include several types of events, for example:

- Critical battery
- Critical temperature
- Software update available
- Network update available
- Routing hardware settings reset
- Device startup failure

- **Wi-Fi user has joined** – Useful, for example, to detect an unwelcome Wi-Fi user if you're the only one using the device.
- **Wi-Fi user has left**
- **Last user has left** – When you hear the device beep, you can turn off the device, if nobody will be using it for awhile.

Tip: You can also disable all sounds through the mute switch on the device. See "Mute Switch" on page 17. If you've enabled the sounds through the home page, but there are no sounds when an event occurs, check the position of the Mute switch.

Home Page Buttons

- ◆ **Buttons Along the Top of the Home Page (page 49)**
- ◆ **Buttons Below the Virtual Device (page 51)**

Buttons Along the Top of the Home Page

The top horizontal part of the home page has the following areas/buttons:

- **Admin Login.** See “Logging On as an Administrator” on page 31.
- **Admin Setup** – Rerun the device setup, for example, after you’ve reset the software to default settings. See “Welcome to Your Device Window - Select an Option” on page 112.
- **Advanced settings.** See “Advanced Settings” on page 49.
- **Map me** – GPS/Location Based Services.
 - Open a Web browser window that shows your current location. See “Viewing Your Current Location in a Web Browser” on page 57.
 - Search for the closest gas station, restaurant, and so on, or do a custom search. See “Performing a Location Search” on page 57.
- **Support.** See “Support Button” on page 50.
- **Feedback** – Send your comments on the device. See “Feedback” on page 50.
- **Help** – Open the online Help, display the important information booklet, or download the user guide.

Admin Setup Button

This button displays a window where you can change the administrator password, Wi-Fi network name (SSID), Wi-Fi security type, and Wi-Fi password.

For more information, see “Welcome to Your Device Window - Select an Option” on page 112.

Advanced Settings

From the Advanced Settings window you can configure all the settings of the device and the browser interface.

The Advanced Settings window has the following tabs; each tab has several panels.

- **Device tab.** See “Device Tab” on page 74.
- **WAN tab.** See “WAN Tab” on page 78.
- **Wi-Fi tab.** See “Wi-Fi Tab” on page 81.
- **Router tab.** See “Configuring the Router Tab” on page 96.

For most fields and buttons, contextual Help appears to the right of the window, when you move the cursor over an item. For more information, see “Contextual Help in the Advanced Settings Window” on page 115.

Accessing the Advanced Settings Window

To access the Advanced Settings window:

1. Ensure you’re logged in to the home page.
2. Click **Advanced settings** ()

Map me Button

The **Map me** button is used for GPS/Location Based Services: you can, for example, search for the closest gas station, restaurant, and so on, or do a custom search.

See “Sprint Location Services” on page 56.

Support Button

The **Support** button opens, in a new Web browser window (or tab), the online support site for your device.

Note: This button is available only when you’re connected to the Internet.

Feedback

The **Feedback** button opens, in a new Web browser window (or tab), the online feedback site for your device.

Note: This button is available only when you’re connected to the Internet.

Help Button

This button displays a menu with options to:

- Display the online Help.
- Download the user guide.
- View the important information booklet. This booklet contains regulatory notices, warranty, and other information.

Buttons Below the Virtual Device

Note: The buttons appear only when you're logged in.

Connect/Disconnect Button

This button disconnects a connection, or connects (if currently there's no connection).

Power Off Button

This button turns the device off.

Note: You can turn the device on by using the device power button.

Section 4G

Using the microSD Card

- ◆ Before Using the microSD Card Slot (page 52)
- ◆ Inserting a microSD Card (page 53)
- ◆ Removing a microSD Card (page 54)
- ◆ Accessing the microSD Card (page 54)

Before Using the microSD Card Slot

1. Enable the slot. See “Enabling the microSD Card Slot” below.
2. Set up access to the slot. See “Setting Up Access to the microSD Card” on page 52.
3. [OPTIONAL]: Rename the **microSD Shared Folder Name**. See “microSD Shared Folder Name” on page 53.
4. Inform others how they can access the card. See “Accessing the microSD Card” on page 54.

Enabling the microSD Card Slot

Before computers can recognize the microSD card, you must enable the microSD slot on the device.

1. Ensure you’re logged in to the home page.
2. In the SD Card Information and Settings window or from **Advanced settings > Device > microSD Card**, select **Enable SD Card**. (See “microSD Card Information and Settings” on page 47.)

Setting Up Access to the microSD Card

If you’ve enabled access to the microSD card, you must also specify whether a username and password are required to access the card.

1. Ensure you’re logged in to the home page.
2. In the SD Card Information and Settings window or from **Advanced settings > Device > microSD Card**, under **Username and Password Security**, select one of the values:
 - To have no security, select **None**.
Anyone can use the card; no username or password is required.
 - To allow only the administrator to use the card, select **Administrator Only**.
When prompted for the username (when you try to use the card), enter “admin”. For the password, enter the home page login password.
 - To allow non-administrators to use the card, select **Administrator + Guest**.

3. If you've selected **Administrator + Guest**:
 - [OPTIONAL]: Change the **Set Guest Username** and **Set Guest Password** fields (up to 20 characters each; spaces are allowed).
 - Give the guest username and password to people whom you want to allow access to the card.

microSD Shared Folder Name

You can optionally change the name of the folder that the microSD card shows up as (in the file browser program); the default folder name is "shared."

1. Ensure you're logged in to the home page.
2. Click **Advanced settings > Device > MicroSD Card**.
3. In the **microSD Shared Folder Name** field, type the new name. (You can use up to 32 letters, numbers, and spaces in any combination.)

For information on how this folder name is used, see "Accessing the microSD Card" on page 54.

Inserting a microSD Card

1. Gently flip open the tab labelled "microSD" on the side of the device.

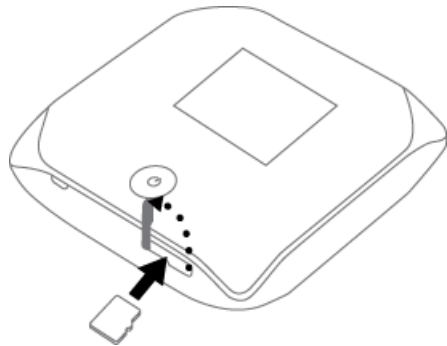

2. Gently insert the microSD card (label facing up) into the slot on the side of the device, until the microSD card clicks into place.

Note: If your microSD card has not been formatted, or is in a format that your computer does not recognize, you may be prompted to format the microSD card. The formatting procedure erases all the data on the microSD card, after which the files CANNOT be retrieved. To prevent the loss of important data, please check the contents before you format the microSD card.

3. Check the status of the microSD card. See "microSD Card Information and Settings" on page 47.

Removing a microSD Card

1. Ensure you and other users have completed any file transfers.
2. Gently flip open the tab labelled “microSD” on the side of the device.

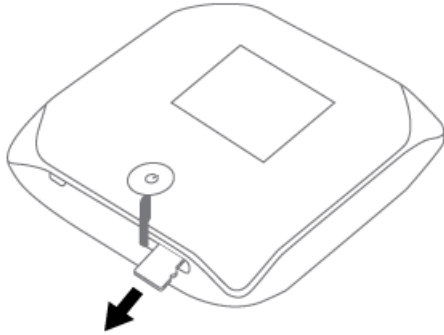

3. Using your fingernail or a thin blunt object, gently press the microSD card in and then release; it should partially pop out of its slot, as shown in the drawing above.
4. Remove the microSD card and store it in a safe place.
5. Close the tab over the microSD slot of the device.

Accessing the microSD Card

If the microSD slot is enabled, an inserted card appears in your file browser as a shared network drive.

The way to access the card varies, depending on your operating system.

Note: In the information that follows, **<Hostname>** is the value of the Hostname field (in **Advanced settings > Wi-Fi > Network** and also in **Advanced settings > Router > LAN**).

Windows

1. In Windows Explorer or Internet Explorer, type one of the following:

- **\\Overdrive**

- **\\<Router IP Address>** (field in **Advanced settings > Router > LAN**)

For example: \\192.168.0.1\

- **\\<Hostname>** (For example: \\MyDeviceName\)

– or –

From the Windows **start** menu, click **start > Run**, and then type one of the following:

- **\\Overdrive**

- **\\<Hostname>**

2. Double-click the shared folder.

Mac

1. In Finder, select **Go > Connect to Server**.
2. Type one of the following:
 - **smb://Overdrive/**
 - **smb://<Router IP Address>/**
 - **smb://<Hostname>**
3. When prompted, select the shared drive as the folder to mount.

Linux

1. Open the run menu (Alt+F2) or a file browser, and type one of the following:
 - **smb://Overdrive/**
 - **smb://<Router IP Address>/**
 - **smb://<Hostname>/**
2. Double-click the shared folder.

Other operating systems

Please see the user documentation for your operating system or computer.

If security has been enabled for the microSD card, you will be prompted to enter the username and password for the microSD card. (See “Setting Up Access to the microSD Card” on page 52.)

Section 4H

Sprint Location Services

- ◆ Requirements for GPS Service (page 56)
- ◆ Enabling GPS (page 56)
- ◆ Displaying Your Location Information (page 56)
- ◆ Viewing Your Current Location in a Web Browser (page 57)
- ◆ Performing a Location Search (page 57)

Requirements for GPS Service

To access GPS services:

- You must accept the GPS privacy agreement.
- GPS must be enabled.

GPS services are not available if you are indoors. GPS receivers must be able to lock onto the global positioning satellites to accurately determine position. The number of obstructions present indoors often makes accurate position determination impossible.

Enabling GPS

1. Ensure you're logged in to the home page.
2. Click the GPS icon  (on the left side of the home page) and select **Enable GPS**.

– or –

Click **Advanced settings > WAN > GPS** and select **Enable GPS**.

Note: If **Enable GPS** is not available, you must accept the GPS privacy agreement. See “GPS Privacy Agreement” on page 35.

3. If the GPS privacy agreement opens, you must read and accept it.

Displaying Your Location Information

1. Ensure you're logged in to the home page.
2. Ensure GPS is enabled.
3. For best results, minimize the number of obstructions between your device and the GPS satellites.
4. Click the GPS icon  (on the left side of the home page).

5. In the GPS Information and Settings window, set **GPS Mode** to **One-time**, and click **Get fix now**. (The top part of the window shows your location information.)

Tip: You can also display location information from **Advanced settings > WAN > GPS** – click **Get fix now**.
Alternatively, you can view your current location in a Web browser. See “Viewing Your Current Location in a Web Browser” on page 57.

Viewing Your Current Location in a Web Browser

1. Ensure GPS is enabled.
2. For best results, minimize the number of obstructions between your device and the GPS satellites.
3. In the horizontal row of buttons (across the top of the home page), click **Map me** ()







Performing a Location Search

To perform a search for establishments near your current location:

1. Ensure GPS is enabled.
2. In the horizontal row of buttons (across the top of the home page), move the mouse over **Map me** () to display a row of icons:



3. Click one of these icons to search for:

	Text (search string) that you enter.
	Sprint stores
	Restaurants
	Local hotels
	Local banks (ATM machines)
	Local gas stations
	Local coffee shops

The results of the search are displayed in a new browser window or tab.

Note: If a window displays “GPS Fix in Progress,” please wait while your device obtains a GPS location fix. When a location fix has been acquired, your Web browser will display the mapping results.

Section 4I

Updates

- ◆ **Automatically Checking for Updates (page 58)**
- ◆ **Manually Checking for Updates (page 59)**
- ◆ **Upgrading Firmware From a File (page 60)**

Note: If a software update, 3G network update, or 3G profile update is available, the device LCD displays a message, and an alert is available from the home page. See “Software Update Available” on page 36 and “3G Network Update Available” on page 35.

The updates may improve performance and add or modify features. The updates may include the following:

- Device firmware
- 3G network update
- The browser interface
- Help files
- Other files

You can:

- Set the browser interface to automatically check for updates (see below).
- Manually check for updates. See “Manually Checking for Updates” on page 59.

Automatically Checking for Updates

To specify how often the browser interface checks for updates:

1. Log in to the home page.
2. Click **Advanced settings** (.
3. Click **Device > Basic**.
4. In the **Check for Updates** list, click a value.

Tip: When updates are available, an alert is shown in the browser interface. See “Alert Information” on page 43.

Manually Checking for Updates

Note: During installation of the update:

- DO NOT turn off or unplug the device.
- Your Wi-Fi and Internet connections won't be available.

When the installation is complete, you will need to reconnect to Wi-Fi. (See "How Do I Connect to Wi-Fi?" on page 116).

1. Log in to the home page.
2. Ensure you're connected to 3G/4G.
3. Click **Advanced settings** (🔑).
4. Click **Device > Basic**.
5. Click **Check for updates now**. (The message next to the button indicates whether updates are available.)

Installing the updates

If updates are available, after you've manually checked for updates:

1. Ensure your device is connected to the AC charger or computer, through the USB to Micro B cable.

Note: If you'll be using USB for data transfer (and not just for charging the device), you must install the device driver. See "Making a Tethered Connection" on page 27.

2. Click **Update options**.
3. Read the information in the Software Installation Options window.
4. To install the update, click **Download and install now**.

– or –

If you are not in a strong signal area, make a note of the URL displayed in the window and click **I'll get the update later**. At a later time, access the URL to download the update to your computer, and then follow the steps in "Upgrading Firmware From a File" on page 60.

5. When the installation is complete, reconnect to Wi-Fi. See "How Do I Connect to Wi-Fi?" on page 116.

Upgrading Firmware From a File

Use this option when you have an updated firmware file that you've, for example, downloaded from the Sprint or Sierra Wireless website.

Note: During installation of the update:

- DO NOT turn off or unplug the device.
- Your Wi-Fi and Internet connections won't be available.

When the installation is complete, you will need to reconnect to Wi-Fi. (See "How Do I Connect to Wi-Fi?" on page 116).

To upgrade the device firmware from a file:

1. Log in to the home page.
2. Ensure **Disable Wi-Fi when connected via USB** is selected. See "Disabling Wi-Fi When Connected Through USB" on page 90.
3. Ensure your device is connected to the AC charger or computer, through the USB to Micro B cable.
4. Click **Advanced settings** (.
5. If you want to later confirm that the upgrade was successful, write down the current version information (shown in **Device > About**):
 - Software version
 - Firmware version (in the 3G Information section)
 - Firmware version (in the 4G Information section)
6. Click **Device > Basic**.
7. [OPTIONAL]: Save the current configuration (recommended).
 - Click **Export**.
 - Save the file. Note the filename and path.
8. Click the **Browse** button next to the **Update Firmware From File** field, and click the firmware file to upload to the device.
9. Click **Update**.

Please wait while the upgrade occurs; this may take several minutes. The device LCD shows the upgrade status. The device will restart (possibly several times).

Once the upgrade is complete, the LCD device shows the usual icons and text (for example, the device name).
10. Compare the current version information (in **Device > About**) to the values you wrote down in step 5 to confirm that the upgrade was successful.

11. If you've saved the current configuration, reload it.
 - Click the **Browse** button next to the **Import Router Settings** field, and click the file you've saved.
 - Click **Import**.
12. Reconnect to Wi-Fi. See "How Do I Connect to Wi-Fi?" on page 116.

Section 4J

Viewing Device Information

To view information about your device:

1. Log in to the home page.
2. Click **Advanced settings** (.
3. Click **Device > About**.

Note: 4G information is not available if **WAN mode** is “3G only.” (**WAN mode** is in **Advanced settings > WAN > Setup**.)

The following information is displayed:

- **Model Number**
- **Manufacturer**
- **Software Version** – Firmware version for the routing hardware of the device.
- **Activation Status** – 3G activated or not activated.
- **Activation Date** – Date that the 3G modem was first activated.
- **Network Operator** – The carrier that your device was activated for.
- **Wi-Fi Firmware Version**
- **Router PRI Version** – PRI version for the routing hardware of the device. The PRI (Product Release Instructions) is a file that contains the settings used to configure wireless products for a particular service provider, customer, or purpose.
- **ESN or MEID (3G).**

The ESN (Electronic Serial Number) is the unique first-generation serial number assigned to the 3G component of the device.

The MEID (Mobile Equipment Identifier) is the unique second-generation serial number assigned to the 3G component of the device.
- **PRI Version** – PRI version of the 3G component of the device.
- **MSID (Mobile Station ID)** – Also known as IMSI (International Mobile Station Identity) – an identifier of a device on the 3G network.
- **PRL Version** – The PRL (Preferred Roaming List) is an account configuration item set by your service provider. It controls the radio channels and network carrier used by the 3G modem. An updated PRL may improve your 3G network service.
- **Firmware Version** – Firmware version of the 3G component of the device.
- **MAC Address** – MAC address of the 4G module. Each wireless device has a unique MAC address (assigned by its manufacturer).
- **Firmware Version** – Firmware version of the 4G component of the device.

The window also has buttons to:

- Save the information to a text file.
- Reset the 3G/4G configuration of the device to default settings. See “Resetting the 3G/4G Configuration to Default Settings” on page 92.

Section 4K

Reset Button

◆ Restarting the Device (page 65)

The reset button is inside the hole located below and to the right of the battery compartment as shown below.

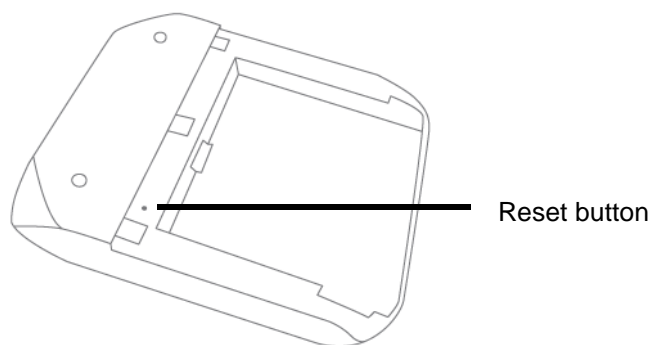

For information on using this button, see “Restarting the Device” (page 65) and “Resetting the Software to Default Settings (Through the Reset Button)” (page 106).

Restarting the Device

Tip: Alternatively, you may be able to restart the device by pressing and holding the power button  on the device for three to four seconds.

If the device or the home page seems to stop responding, you can reset (restart) the device:

1. Remove the battery compartment cover from the device.

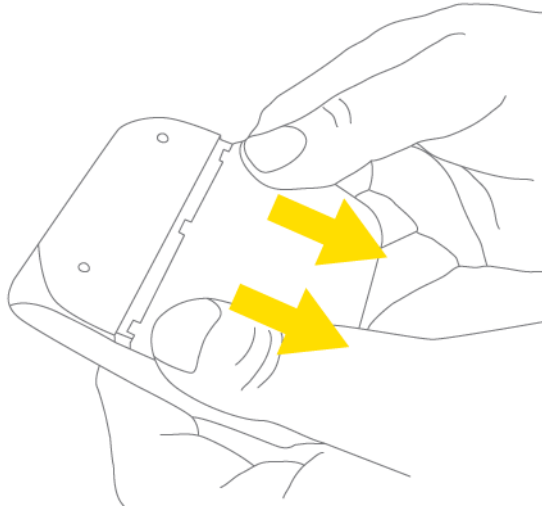

2. Find the small hole below and to the right of the battery compartment. The reset button is inside this hole.

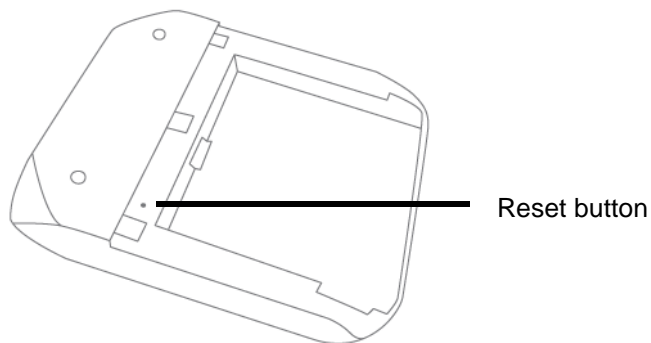

3. Insert a thin object (for example, the end of a paper clip) into the hole, and lightly press on the bottom of the hole for about a second.

4. Replace the battery compartment cover.

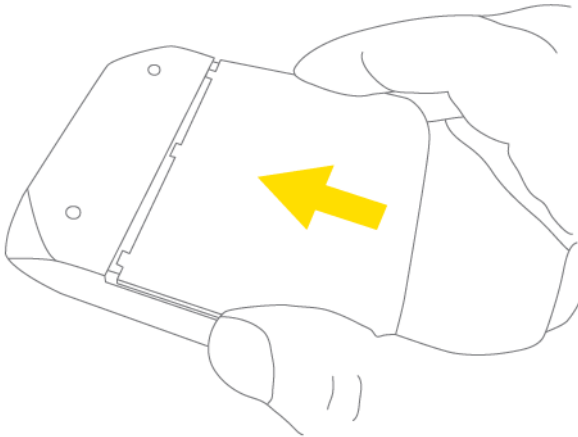

Section 5
Settings



- ◆ **Battery and USB Power Settings** (page 68)
- ◆ **AC Power Settings** (page 68)

Battery and USB Power Settings

You can specify the settings for battery power and USB power:

- **Better battery life** – At the cost of a shorter Wi-Fi range.
- **Longer Wi-Fi range** – At the cost of a shorter battery life.

To choose an option:

1. Ensure you're logged in to the home page.
2. Click the battery icon . The Battery Information and Settings window opens.
– or –
Click **Advanced settings > Wi-Fi > Network**.
3. Select an option in the **Battery or USB Powered** section.

AC Power Settings

You can specify the settings for AC power:

- **Longer Wi-Fi range**
- **Shorter Wi-Fi range**

To choose an option:

1. Ensure you're logged in to the home page.
2. Click the battery icon . The Battery Information and Settings window opens.
– or –
Click **Advanced settings > Wi-Fi > Network**.
3. Select an option in the **AC Powered** section.

Configuring the LCD

- ◆ Turning the LCD On or Off (page 69)
- ◆ Setting the LCD Timeout (page 69)
- ◆ Setting the LCD Brightness (page 69)

Turning the LCD On or Off

1. Log in to the home page.
2. Click **Advanced settings > Device > Display**.
3. Set the **LCD Backlight** field to **On** or **Off**. (“**Off**” helps prolong the battery life, but you can’t check the LCD for status icons and messages.)

Setting the LCD Timeout

Tip: Alternatively, you can permanently turn off the LCD, in which case it will never become lit and will not display text and icons. See “Turning the LCD On or Off” on page 69.

To set the amount of time, after which the LCD of the device temporarily turns off:

1. Ensure you’re logged in to the home page.
2. Click **Advanced settings > Device > Display**.
3. Ensure **LCD Backlight** is set to **On**.
4. In the **Turn Off Backlight** list, click a value. (A smaller value helps prolong the battery life.)

Note: The LCD turns on if an important system event occurs.

Setting the LCD Brightness

1. Ensure you’re logged in to the home page.
2. Click **Advanced settings > Device > Display**.
3. Ensure **LCD Backlight** is set to **On**.
4. Select a value for **On Battery/USB Power**. (A lower brightness prolongs the battery life.)
5. Select a value for **On AC Power**.

Section 5C

Enabling and Disabling the LED

The power button  on the device acts as an LED/status indicator, and may or may not be lit. For more information, see “Using the Power Button to Determine the Device State” on page 14.

To enable or disable the lighting of the power button :

1. Log in to the home page.
2. Click **Advanced settings > Device > Display**.
3. Set the **Power Button LED** field to **On** or **Off**.

- ◆ Enabling and Disabling Sounds for Specific Events (page 71)
- ◆ Low Battery Alert (page 72)
- ◆ Critical Battery Level Alert (page 72)

You can enable or disable sounds of the device through:

- The mute switch on the device (disables all sounds). See “Mute Switch” on page 17.
- The browser interface (selectively disables sounds). See “Sounds Information and Settings” on page 48 and “Enabling and Disabling Sounds for Specific Events” on page 71.

Enabling and Disabling Sounds for Specific Events

1. Log in to the home page.
2. Click **Advanced settings > Device > Sounds**.
3. Next to each of the event types, select **Enable** or **Disable**.

Sounds for the following events can be individually enabled or disabled:

- Low battery alert

Useful as a reminder to charge the device. In the **Alert When** list, you can select a battery level to trigger the alert.

- System alerts

When you hear the device beep, use the device LCD or the Alerts window to get information about the alert. See “Alert Information” on page 43.

Note: System alerts include several types of events, for example:

- Critical battery
- Critical temperature
- Software update available
- Network update available
- Routing hardware settings reset
- Device startup failure

- **Internet Connected**
- **Internet Disconnected**
- **Wi-Fi User Has Joined** – Useful, for example, if you’re the only one using the device, to detect an intruder.
- **Wi-Fi User Has Left**
- **Last User Has Left** – You can turn off the device if nobody will be using it for a while.

Low Battery Alert

You can set an alert to sound when the battery level is low.

Setting the Alert From the Home Page

1. Ensure you're logged in to the home page.
2. Click the Sounds icon ()
3. In the Sounds window, select **Low battery**.

Setting the Alert From the Advanced Settings Window

1. Log in to the home page.
2. Click **Advanced settings > Device > Sounds**.
3. For the **Low Battery** field, select **Enable**.
4. In the **Alert When** list, select the battery level to trigger the alert.

Critical Battery Level Alert

You can enable an alert to sound when the battery level is critical (that is, dangerously low).

1. Log in to the home page.
2. Click **Advanced settings > Device > Sounds**.
3. For the **System Alerts** field, select **Enable**.

Note: System alerts include several types of events, for example:

- Critical battery
- Critical temperature
- Software update available
- Network update available
- Routing hardware settings reset
- Device startup failure

Section 5E

Login Settings

- ◆ Changing the Administrator Password (page 73)
- ◆ Automatic Login (“Remember Me”) (page 73)

Changing the Administrator Password

Note: If you forget the Admin Login password, you'll need to reset the device to its default settings and go through the device setup. See "What Do I Do if I Forgot the Administrator Password?" on page 117.

1. Log in to the home page.
2. Click **Advanced settings > Device > Basic**.
3. In the **Admin Password** field, type the new password (1–20 characters/numbers).

Automatic Login (“Remember Me”)

If you enable automatic login:

- Anyone who uses the computer will automatically be logged in to the home page (as long as no one else has already logged in from another computer); entering the administrator password is not required.
- The timeout security feature is disabled – you will never be automatically logged off.

To enable automatic login:

1. From the computer that you want to enable automatic login, log in to the home page.
2. In the login area, select the **Remember me** check box.

You can repeat the above steps on other computers; however, since only one administrator can be logged in at a time, only the first person to display the home page will be logged in.

Viewing Computers That Are Set to Automatically Log In as Administrator

1. Log in to the home page.
2. Click **Advanced settings > Device > Basic**.
3. Next to **Remember me Client List**, click **show list**.

Disabling Automatic Login For a Specific Computer

1. Log in to the home page.
2. Click **Advanced settings > Device > Basic**.
3. Next to **Remember me Client List**, click **show list**.
4. In the row for the computer that you want to disable automatic login, click **Remove**.

Advanced Settings

- ◆ Accessing the Advanced Settings Window (page 74)
- ◆ Device Tab (page 74)
- ◆ WAN Tab (page 78)
- ◆ Wi-Fi Tab (page 81)

From the Advanced Settings window you can configure all the settings of the device and the browser interface.

The Advanced Settings window has the following tabs; each tab has several panels.

- Device tab. See “Device Tab” on page 74.
- WAN tab. See “WAN Tab” on page 78.
- Wi-Fi tab. See “Wi-Fi Tab” on page 81.
- Router tab. See “Configuring the Router Tab” on page 96.

For most fields and buttons, contextual Help appears to the right of the window, when you move the cursor over an item. For more information, see “Contextual Help in the Advanced Settings Window” on page 115.

Accessing the Advanced Settings Window

1. Ensure you’re logged in to the home page.
2. Click **Advanced settings** (.

Device Tab

Basic Panel

1. Log in to the home page.
2. Click **Advanced settings** (.
3. Click **Device > Basic**.

From this window, you can view or adjust these settings, or perform the following actions:

- Login password. See “Changing the Administrator Password” on page 73.
- Computers that are set to automatically log in. See “Automatic Login (“Remember Me”)” on page 73.
- Enable or disable contextual Help in the Advanced Settings window (**Help for Advanced Settings**). See “Contextual Help in the Advanced Settings Window” on page 115.
- Import configuration settings. See “Importing Settings” on page 108.

- Export configuration settings. See “Exporting Settings” on page 108.
- Update firmware from a file. See “Upgrading Firmware From a File” on page 60.
- Enable standby (low power) mode (**Standby Timer on Battery or USB** and **On AC Power**). See “Standby (Low Power) Mode” on page 46.
- Enable TRU-Install. For information on this feature, see “TRU-Install” on page 26.
- Download the Windows or Mac driver (if you’re using USB for data transfer). See “Making a Tethered Connection” on page 27.
- Check for updates. See “Automatically Checking for Updates” on page 58 and “Manually Checking for Updates” on page 59.
- Reset 3G/4G configuration to default settings. See “Resetting the 3G/4G Configuration to Default Settings” on page 92.

Display Panel

From the **Display** panel of the **Device** tab, you can configure settings for the device LCD.

To access this panel:

1. Log in to the home page.
2. Click **Advanced settings** (🔍).
3. Click **Device > Display**.

From this window, you can view or adjust these settings:

- Lighting of the power button  on the device (**Power Button LED**). See “Enabling and Disabling the LED” on page 70.
- Turn the LCD on or off (**LCD Backlight**). See “Turning the LCD On or Off” on page 69.
- LCD timeout – how soon the LCD goes dormant (**Turn Off Backlight**). See “Setting the LCD Timeout” on page 69.
- Brightness of the LCD (**Backlight Settings**). See “Setting the LCD Brightness” on page 69.

microSD Card Panel

1. Log in to the home page.
2. Click **Advanced settings** (🔍).
3. Click **Device > microSD Card**.

From this window, you can view or adjust these settings, or perform the following actions:

- Status of the microSD card slot.
- Enable the microSD card slot. See “Enabling the microSD Card Slot” on page 52.
- Folder name for the shared micro SD card. See “microSD Shared Folder Name” on page 53.
- Set up access to the microSD Card. See “Setting Up Access to the microSD Card” on page 52.

Sounds Panel

From the **Sounds** panel of the **Device** tab, you can enable or disable sounds for specific types of events.

1. Log in to the home page.
2. Click **Advanced settings** (🔑).
3. Click **Device > Sounds**.
4. Next to each of the event types, select **Enable** or **Disable**.

Sounds for the following events can be individually enabled or disabled:

- **Low Battery** – Useful as a reminder to charge the device. In the **Alert When** list, you can select a battery level to trigger the alert.
- **System Alerts** – When you hear the device beep, use the device LCD or the Alerts window to get information about the alert. See “Alert Information” on page 43.

Note: System alerts include several types of events, for example:

- Critical battery
- Critical temperature
- Software update available
- Network update available
- Routing hardware settings reset
- Device startup failure

- **Internet Connected**
- **Internet Disconnected**
- **Wi-Fi User Has Joined** – Useful, for example, if you’re the only one using the device, to detect an intruder.
- **Wi-Fi User Has Left**
- **Last User Has Left** – You can turn the device off if nobody will be using it for a while.

About Panel

To view information about your device:

1. Log in to the home page.
2. Click **Advanced settings** (🔑).
3. Click **Device > About**.

Note: 4G information is not available if **WAN mode** is “3G only.” (**WAN mode** is in **Advanced settings > WAN > Setup**.)

The following information is displayed:

- **Model Number**
- **Manufacturer**
- **Software Version** – Firmware version for the routing hardware of the device.
- **Activation Status** – 3G activated or not activated.
- **Activation Date** – Date that the 3G modem was first activated.
- **Network Operator** – The carrier that your device was activated for.
- **Wi-Fi Firmware Version**
- **Router PRI Version** – PRI version for the routing hardware of the device. The PRI (Product Release Instructions) is a file that contains the settings used to configure wireless products for a particular service provider, customer, or purpose.
- **MSID** (Mobile Station ID) – Also known as IMSI (International Mobile Station Identity) – an identifier of a device on the 3G network.
- **PRI Version** – PRI version of the 3G component of the device.
- **ESN or MEID.**

The ESN (Electronic Serial Number) is the unique first-generation serial number assigned to the 3G component of the device.

The MEID (Mobile Equipment Identifier) is the unique second-generation serial number assigned to the 3G component of the device.

- **PRL Version** – The PRL (Preferred Roaming List) is an account configuration item set by your service provider. It controls the radio channels and network carrier used by the 3G modem. An updated PRL may improve your 3G network service.
- **Firmware Version** – Firmware version of the 3G component of the device.
- **MAC Address** – MAC address of the 4G module. Each wireless device has a unique MAC address (assigned by its manufacturer).
- **Firmware Version** – Firmware version of the 4G component of the device.

The window also has buttons to:

- Save the information to a text file.
- Reset the 3G/4G configuration of the device to default settings. See “Resetting the 3G/4G Configuration to Default Settings” on page 92.

Log Panel

1. Log in to the home page.
2. Click **Advanced settings** (.
3. Click **Device > Log**.

From this window, you can:

- Enable logging of system events. See “Enabling and Disabling Logging of System Events” on page 110.
- Enable logging of connects/disconnects. See “Enabling and Disabling Logging of Connect/Disconnects” on page 109.
- Export logs. See “Exporting System Events” on page 110 and “Exporting the Connection History” on page 109.
- Clear logs. See “Clearing the System Events Log” on page 110 and “Clearing the Connection History” on page 109.
- Set the method used for time acquisition. See “Setting the Method Used for Time Acquisition” on page 111.

WAN Tab

See also “3G Panel” on page 91.

Setup Panel

1. Log in to the home page.
2. Click **Advanced settings** (🔍).
3. Click **WAN > Setup**.

From this window, you can view or adjust these settings, or perform the following actions:

- **Active Network** – Network that is currently being used for your data connection: 3G, 4G, or none.
- **Network Operator** – The carrier that your device was activated for.
- **Session Duration** – How long you’ve been connected to the network.
- **Session Total Data** – Amount of data transferred over the lifetime of the device (by network type) and in the current session.
- **WAN Mode** – Network(s) to connect to, and in what order.
 - **4G preferred** – Connection can be established to either 3G or 4G; if both are available, 4G is used. This setting is recommended if your service provider has no data limit for 4G, but does for 3G, or you want to take advantage of the faster data transfer speeds of 4G.
 - **3G preferred** – Connection can be established to either 3G or 4G; if both are available, 3G is used.
 - **4G only** – Connection can be established only to 4G.
 - **3G only** – Connection can be established only to 3G.
If you don’t have 4G coverage, you can save power by selecting “3G Only.”
- **Connect Automatically** to the network when the device powers on.

- **Failover wait time** – How long the device should wait, after it loses the connection with the preferred network, before it attempts to connect to the other network (not available if **WAN mode** is “3G only” or “4G only”).
- **Switchback wait time** – How long the device should wait, when the less-preferred network is connected and the preferred network becomes available, before switching to the preferred network (not available if **WAN mode** is “3G only” or “4G only”).
- **Update 3G PRL** – Check whether an updated PRL is available.

The PRL (Preferred Roaming List) is an account configuration item set by your service provider. It controls the radio channels and network carrier used by the 3G modem. An updated PRL may improve your 3G network service.

Note: A 3G connection to the Internet won't be available until the update is complete. (The 4G connection won't be affected.)

- **Update 3G Profile** – Check whether an updated profile for your 3G connection is available. An updated profile may improve your 3G network service.
- **Manual Activation** – Configure Data Link and the Mobile IP settings. (If you need help, please contact Sprint.)

4G Panel

1. Log in to the home page.
2. Click **Advanced settings** (🔍).
3. Click **WAN > 4G**.

Note: 4G information is not available if **WAN mode** is “3G only.” (**WAN mode** is in **Advanced settings > WAN > Setup**.)

From this window, you can view this 4G information:

- **Connection Status** – Connected, or not connected.
- **Coverage Type** – 4G, 4G Off, or no service.
- **RSSI** and **CINR**.

RSSI reflects the signal strength of the network.

CINR stands for Carrier to Interference-plus-Noise Ratio, and is a measurement of signal effectiveness. For the receiver to decode the carrier signal, the latter must be in an acceptable CINR range.

- **Tx Power** – Transmitter power. A higher number is better.
- **Center Frequency** – Frequency of the 4G channel used for the data connection.
- **NSP-ID** – ID of the 4G Network Service Provider.
- **NAP-ID** – ID of the 4G Network Access Provider.
- **BSID** – Base Station ID.

GPS Panel

1. Log in to the home page.
2. Click **Advanced settings** (🔍).
3. Click **WAN > GPS**.

From this window, you can view or adjust these settings, or perform the following actions:

- **Enable GPS** – To use GPS, and to configure other GPS settings, this check box must be selected. If the GPS privacy agreement opens, you must accept it before you can use GPS.
- **GPS Mode** – How often the device should obtain a fix.
 - **One-time** – Use a single fix. Use this option if you'll be using your device at the same location.
 - **Continuous** – Obtain fixes on a regular basis. Also known as auto-tracking. Useful for navigation or turn-by-turn (TBT) applications (for example, driving directions).
- **Mapping Service** – The mapping service (for example, Google Maps or MapQuest) that displays the GPS results (in a separate browser window).
- **Performance Value** – Amount of time the device should wait for a satellite to be discovered.
 - **Automatic** – The device automatically determines the most appropriate setting to use.
 - **Manual** – In the input field, enter the number of seconds the device should wait for a satellite to be discovered. If this time is exceeded, an error is reported.
- **Accuracy**
 - **Automatic** – The device automatically determines the most appropriate setting to use.
 - **Manual** – In the input field, enter the number of meters to which the data must be accurate.
Note: If the value is very small (i.e. very high accuracy), the fix may fail.
- **Fix Rate** – The smaller the number, the more up-to-date the location tracking will be, at the cost of shorter battery life of the device. Available only if **GPS Mode** is set to **Continuous**.
- **Metric Units** – Specifies whether to use the metric system when displaying the GPS results (for example, the altitude, speed, HEPE).
- **Get fix now** – This button starts a one-time fix (not displayed if **GPS Mode** [above] is **Continuous** or a GPS session is already in progress). If you change the value from **Continuous** to **One-time**, you must click **Save** before your changes take effect and the fix becomes possible.
- **Show GPS Data** or **Hide GPS Data**

Wi-Fi Tab

Network Panel

1. Log in to the home page.
2. Click **Advanced settings** (🔑).
3. Click **Wi-Fi > Network**.



From this window, you can view or adjust these settings, or perform the following actions:

- **Disable Wi-Fi upon USB-PC** – Only a computer that is connected to the device through the USB to Micro B cable can use the device. See “Disabling Wi-Fi When Connected Through USB” on page 90.
- **SSID** – Wi-Fi network name; identifies your Wi-Fi network, and is visible to other Wi-Fi-enabled devices. See “SSID (Wi-Fi Network Name)” on page 83.
- **Hostname** – Device name. See “Host Name (Device Name)” on page 89 and “Displaying the Home Page of the Device” on page 31.
- **Link SSID and Hostname**. See “Linking the SSID and the Host Name” on page 84.
- **SSID Broadcast** – If broadcast is enabled, the wireless network is displayed in the list of Wi-Fi networks available in the local area. For increased security, set this field to **Disable**. You will need to give the SSID to the people who will be accessing your network.
- **Max Number of Users** – Limits the number of Wi-Fi users that can connect to the device. A smaller number improves performance and security.
- **Battery or USB Powered** (power settings)
 - **Better battery life** – At the cost of a shorter Wi-Fi range.
 - **Longer Wi-Fi range** – At the cost of a shorter battery life.
- **AC Powered** (power settings)
 - **Longer Wi-Fi range**
 - **Shorter Wi-Fi range**
- **Wi-Fi Channel** – The active channel of the Wi-Fi access point. If your network is having performance issues (possibly caused by other Wi-Fi networks in the vicinity using the same channel), try a different Wi-Fi channel.
- **Basic Rate** – Type of wireless devices connected to your network.

If you're certain that all of the Wi-Fi devices used with your device support 802.11g, then select **802.11g only** (this ensures faster Wi-Fi speeds); otherwise, select **802.11b/g compatibility**.

- **RTS Threshold** – Specifies the smallest packet size, in bytes, for which RTS/CTS (Request to Send/Clear to Send) handshaking is used. The recommended value is 2347.

Change this value only if you're experiencing inconsistent data flow. Make only minor changes to this value.

- **Fragmentation Threshold** – Specifies the largest allowable size, in bytes, for a packet. If the packet is larger than this, it is fragmented into multiple packet before it is transmitted. To prevent poor network performance, it's recommended to keep this value as large as possible (up to 2345).
- **List of connected devices** – Display a window that shows connected computers. A table row may optionally show one or both of these icons:
 -  –The user of this computer is logged in as administrator.
 -  –This computer is connected to the device through the USB to Micro B cable.

Security Panel

1. Log in to the home page.
2. Click **Advanced settings** ().
3. Click **Wi-Fi > Security**.

From this window, you can set the:

- Wi-Fi security type. See “Wi-Fi Security” on page 85.
- Wi-Fi password. See “Wi-Fi Password” on page 86.
- Wi-Fi Password Reminder feature. See “Wi-Fi Password Reminder” on page 86.

MAC Filter Panel

The MAC (Media Access Control) filter is used to grant (“whitelist”) or block (“blacklist”) wireless devices access to the Wi-Fi, 3G, and 4G networks. Access is based on the MAC address of each wireless device.

MAC filtering can prevent unauthorized wireless devices from connecting to your network.

MAC filtering increases security of your network. You can give access to your network, based on the MAC address of the wireless devices. This makes it harder for a hacker to use a MAC address to access your network.

To access this panel:

1. Log in to the home page.
2. Click **Advanced settings** ().
3. Click **Wi-Fi > MAC Filter**.

From this window, you can:

- Display a list of computers that are:
 - Allowed to access the network (**MAC Filter Mode** = “Allow all in list”)
 - Not allowed to access the network (**MAC Filter Mode** = “Block all in list”)
- Add or remove a computer from the lists. See “Specifying Computers That Can Access the Network” on page 87 and “Specifying Computers That Are Not Allowed to Access the Network” on page 88.
- Display a list of computers that are currently connected through Wi-Fi. See “Displaying a List of Currently Connected Computers” on page 88.

Configuring the Wi-Fi Network

- ◆ SSID (Wi-Fi Network Name) (page 83)
- ◆ Wi-Fi Security (page 85)
- ◆ Host Name (Device Name) (page 89)
- ◆ Setting the Maximum Number of Wi-Fi Users (page 89)
- ◆ Wi-Fi Channel (page 90)
- ◆ Disabling Wi-Fi When Connected Through USB (page 90)

You can configure basic settings of the Wi-Fi network through the setup pages.

1. Ensure you're logged in to the home page.
2. Click **Admin Setup** .

For more information, see "Changing the Password and Settings" on page 21.

You can configure basic and advanced settings of the Wi-Fi network through the **Advanced Settings** window.

1. Log in to the home page.
2. Click **Advanced settings** .
3. Click **Wi-Fi > Network**.

For more information, see "Network Panel" on page 81.

See also:

- "Disabling Wi-Fi When Connected Through USB" on page 90.
- "Battery and USB Power Settings" on page 68.
- "AC Power Settings" on page 68.

SSID (Wi-Fi Network Name)

The SSID identifies your Wi-Fi network and is visible to other Wi-Fi-enabled devices. It appears on your device's LCD screen; if more than one Overdrive 3G/4G Mobile Hotspot is available, you can use this name to tell the devices apart.

You can display the home page by typing the SSID in your Web browser (if **Link SSID and Hostname** is selected; see "Linking the SSID and the Host Name" on page 84).

You should make the SSID unique and change it on a regular basis for optimal security.

To change the SSID:

1. Log in to the home page.
2. Click **Advanced settings > Wi-Fi > Network**.
3. In the **SSID** field, enter the new name.

If the SSID field is not available, **Link SSID and Hostname** is enabled. You must either edit **Hostname** (and the SSID will get the same value), or disable **Link SSID and Hostname** and edit the SSID.

4. Click **Save**.
5. Reconnect to Wi-Fi: follow the instructions on-screen, and see “How Do I Connect to Wi-Fi?” on page 116.

Note: If you're sharing your connection with others, they also must reconnect to Wi-Fi; provide them the new SSID.
For security reasons, it's recommended you disable SSID Broadcast. See "Network Panel" on page 81.

Linking the SSID and the Host Name

If you link the **SSID** (Wi-Fi network name) and the **Hostname** (name of your device):

- The SSID becomes whatever the Hostname is (you cannot change the SSID – only the Hostname).
- You only need to remember one name when selecting the Wi-Fi network, accessing the browser interface, or accessing the microSD card.

To link the SSID and the Hostname:

1. Log in to the home page.
2. Click **Advanced settings** (🔍).
3. Click **Wi-Fi > Network** or **Router > LAN**.
4. Select the **Link SSID and Hostname** check box.

The **SSID** field gets the value of **Hostname** and becomes unavailable (grayed out).

5. Click **Save**.

The device resets, after which you must reconnect to Wi-Fi. See “How Do I Connect to Wi-Fi?” on page 116.

Wi-Fi Security

By default, Wi-Fi security is enabled for your device and the Wi-Fi network.

Note: All the devices used with the Overdrive 3G/4G Mobile Hotspot must support the selected security type.

To change the security used by Wi-Fi:

1. Log in to the home page.
2. Click **Advanced settings > Wi-Fi > Security**.
3. Select one of the options:
 - **None** – No security (no password is required to access the Wi-Fi network); not recommended. Anyone may access your device and use your Internet connection (you are responsible for payment for data usage).
 - **WEP-64 Bit - Shared** – Lower security. Works with older and newer Wi-Fi devices. Recommended only if any of your devices don't support WPA or WPA2.
Shared WEP uses the same key for encryption and authentication; some consider shared WEP to be less secure than open WEP.
 - **WEP-128 Bit - Shared** – Lower security. Works with older and newer Wi-Fi devices. Recommended only if any of your devices don't support WPA or WPA2.
Shared WEP uses the same key for encryption and authentication; some consider shared WEP to be less secure than open WEP.
 - **WEP-64 Bit - Open** – Lower security. Works with older and newer Wi-Fi devices. Recommended only if any of your devices don't support WPA or WPA2.
Open WEP uses the key for encryption, but not for authentication.
 - **WEP-128 Bit - Open** – Lower security. Works with older and newer Wi-Fi devices. Recommended only if any of your devices don't support WPA or WPA2.
Open WEP uses the key for encryption, but not for authentication.
 - **WPA-Personal - TKIP** – A strong security standard, supported by most Wi-Fi devices.
 - **WPA-Personal - TKIP/AES** – A strong security standard, supported by most Wi-Fi devices.
 - **WPA2-Personal - AES** – A stronger, newer security standard. Limited to newer Wi-Fi devices.
 - **WPA2-Personal - TKIP/AES** – A stronger, newer security standard. Limited to newer Wi-Fi devices.
 - **WPA/WPA2 Personal** (recommended setting) – Wi-Fi devices that use either WPA or WPA2 can connect to the device. Supported by most Wi-Fi devices.
4. Click **Save**.

The option you select determines the Wi-Fi security used and also the maximum length of the Wi-Fi password.

Wi-Fi Password

If Wi-Fi security is enabled, a Wi-Fi password is required to connect to the Wi-Fi network.

Some general rules to make your password more secure:



- Use letters and numbers
- Use special characters (for example, @)
- Use both uppercase and lowercase letters

To change the Wi-Fi password:

1. Log in to the home page.
2. Click **Advanced settings > Wi-Fi > Security**.
3. In the **Wi-Fi password** field, type the password; the maximum length depends on the Wi-Fi security type that you've selected.
 - **None** – No security (no password is required to access the Wi-Fi network); not recommended. Anyone may access your device and use your Internet connection (you are responsible for payment for data usage).
 - **WEP-64 bit - Shared** – 5 ASCII characters.
 - **WEP-128 bit - Shared** – 13 ASCII characters.
 - **WEP-64 bit - Open** – 5 ASCII characters.
 - **WEP-128 bit - Open** – 13 ASCII characters.
 - **WPA-Personal - TKIP** – ASCII string, 8 to 63 characters.
 - **WPA-Personal - TKIP/AES** – ASCII string, 8 to 63 characters.
 - **WPA2-Personal - AES** – ASCII string, 8 to 63 characters.
 - **WPA2-Personal - TKIP/AES** – ASCII string, 8 to 63 characters.
 - **WPA/WPA2 Personal** – ASCII string, 8 to 63 characters.
4. Click **Save**.

Wi-Fi Password Reminder

When the Wi-Fi Password Reminder feature is enabled, you can display the Wi-Fi password on the LCD of the device:

1. If the LCD is dark (no text or icons are displayed):
 - Ensure the LCD is enabled. See “Turning the LCD On or Off” on page 69.
 - Briefly press the power button  on the device.
2. Press the power button  on the device twice, quickly (within 0.5 seconds).

The information is displayed for approximately 20 seconds. To clear the information before that, briefly press the power button  on the device.

Enabling the Wi-Fi Password Reminder

1. Log in to the home page.
2. Click **Advanced settings > Wi-Fi > Security**.
3. In the **Password Reminder** section, select **On**.
4. Click **Save**.

Allowing or Denying Computers Access to the Network

The MAC (Media Access Control) filter is used to grant (“whitelist”) or block (“blacklist”) wireless devices access to the Wi-Fi, 3G, and 4G networks. Access is based on the MAC address of each wireless device.

MAC filtering can prevent unauthorized wireless devices from connecting to your network.

You can choose one of three modes:

- **No filtering** – All computers are allowed to access the network.
- **Allow all in list** – Only computers that are in this list are allowed to access the network.
- **Block all in list** – All computers are allowed to access the network, unless they’re in this list.

In any case, a user still needs to provide the correct Wi-Fi password to access the network.

Specifying Computers That Can Access the Network

1. Log in to the home page.
2. Click **Advanced settings > Wi-Fi > MAC Filter**.
3. In the **MAC Filter Mode** list, click **Allow all in list**.
4. Do one of the following:
 - If the computer you want to allow access is currently connected to the Overdrive 3G/4G Mobile Hotspot, click **List of connected devices**.
In the row for the computer, click **Add**.
– or –
 - Click **Add**.
In the **MAC Address** field, enter the MAC address of the computer you’re adding to the list. (If you don’t know this address, see “Finding the MAC Address” on page 122.)
In the **Name** field, enter a name, for example “Amy’s PC.”
5. Repeat step 4 for each computer you want to allow access.

Specifying Computers That Are Not Allowed to Access the Network

1. Log in to the home page.
2. Click **Advanced settings > Wi-Fi > MAC Filter**.
3. In the **MAC Filter Mode** list, click **Block all in list**.
4. Determine and block an undesired user of your network.
 - Click the **List of connected devices** link.
 - If you see a device you don't recognize, you can compare its MAC address to the MAC address of each of the devices on your network.

To determine the MAC address of each device you have, see "Finding the MAC Address" on page 122. If none of your devices have this MAC address, that device might be an intruder.
 - In the row for the device you want to block, click **Add**.
5. For each computer you want to block, repeat step 4.

Tip: The Connected Users window has a **Block** check box, available for each currently connected user (except the administrator []). See "Wi-Fi Users Information and Settings" on page 45.

Removing a Computer From the Allowed or Disallowed Lists

1. Log in to the home page.
2. Click **Advanced settings > Wi-Fi > MAC Filter**.
3. In the **MAC Filter Mode** list, click either **Allow all in list** or **Block all in list**.
4. Click the row that you want to remove.

A row of buttons (**Delete**, **OK**, **Cancel**) appears.
5. Click **Delete**.

Displaying a List of Currently Connected Computers

1. Ensure you're logged in to the home page.
 2. Click the  icon to display the Connected Users window.

— or —

Click **Advanced settings > Wi-Fi > Mac Filter**, and click **List of connected devices**.
- A row displays the  icon if the user is logged in as administrator.

Host Name (Device Name)

The host name is, in essence, a name you're giving the device.

The host name is shown on your device's LCD screen; if more than one device is available, you can use this name to tell the devices apart. See "Linking the SSID and the Host Name" on page 84.

This name is also used when you type a command to access the:

- Home page. See "Displaying the Home Page of the Device" on page 31.
- microSD card. See "Accessing the microSD Card" on page 54.

To change the host name:

1. Log in to the home page.
2. Click **Advanced settings** ()
3. Click **Wi-Fi > Network** or **Router > LAN**.
4. In the Hostname field, enter a name for your device.

Input rules:

1–15 ASCII characters. Valid characters are:

- a-z
- A-Z
- 0-9. Note that the host name cannot be all numbers.
- - (hyphen). Note that the host name cannot start or end with a hyphen.

Setting the Maximum Number of Wi-Fi Users

If your network is having performance issues, you might want to decrease the number of Wi-Fi users allowed to connect to the device.

1. Ensure you're logged in to the home page.
2. Click the  icon and, in the Connected Users window, click a value in the **Max Wi-Fi users** list.

– or –

Click **Advanced settings > Wi-Fi > Network**, and click a value in the **Max Number of Users** list.

Wi-Fi Channel

The Wi-Fi channel is the active channel of the Wi-Fi access point. If your network is having performance issues (possibly caused by other Wi-Fi networks in the vicinity using the same channel), try a different Wi-Fi channel.

1. Log in to the home page.
2. Click **Advanced settings > Wi-Fi > Network**.
3. Click a channel number in the **Wi-Fi Channel** list, or, to have the device automatically determine the channel to use, click **Auto**.

Disabling Wi-Fi When Connected Through USB

You can optionally turn off the device's Wi-Fi when connected via the USB to Micro B cable. In this case:

- Only a computer that is connected to the device through the USB to Micro B cable can use the device.
- You can prolong the battery life of the device.
- The battery charges faster.

To enable this feature:

1. Ensure you're logged in to the home page.
2. Click the Wi-Fi users icon (for example, ) and select **Disable Wi-Fi when connected via USB**.

– or –

Click **Advanced settings > Wi-Fi > Network** and set **Disable Wi-Fi upon USB-PC** to **On**.

- ◆ Viewing 3G Activation Information (page 91)
- ◆ 3G Panel (page 91)
- ◆ Resetting the 3G/4G Configuration to Default Settings (page 92)

Viewing 3G Activation Information

1. Log in to the home page.
2. Click **Advanced settings** (🔑).
3. Click **Device > About**.

The following fields are related to 3G activation:

- **Activation Status** – Activated or not activated.
- **Activation Date** – Date that the 3G modem was first activated.
- **Network Operator** – The carrier that your device was activated for.

3G Panel

1. Log in to the home page.
2. Click **Advanced settings** (🔑).
3. Click **WAN > 3G**.

From this window, you can view or update this information, or perform the following actions:

- **Connection Status:** connected, not connected, or dormant.
Dormant means a connection is established, but no data is being transferred.
- **Service Type** used for the data connection (1xRTT, EVDO, or EVDO Rev. A).
- **Coverage Type** available, and RSSI and Ec/Io for each type.
RSSI reflects the signal strength of the network.
Ec/Io is a dimensionless ratio of the average power of a channel, typically the pilot channel, to the total signal power.
- **MDN** (Mobile Directory Number) – a 10-digit phone number.
- **SID** (System ID) – The System ID identifies your home network area and is used in conjunction with your phone number to determine if you are “home” or “roaming.”
- **MSID** (Mobile Station ID) – Also known as IMSI (International Mobile Station Identity) – an identifier of a device on the 3G network.
- **NAI** (Network Access Identifier) – User ID for accessing the 3G network.

- **Roaming Status** – Home, or roaming (outside of Sprint coverage).
- **Allow 3G Roaming** – enable or disable 3G roaming.
- **PRL Version** – The PRL (Preferred Roaming List) is an account configuration item set by your service provider. It controls the radio channels and network carrier used by the 3G modem. An updated PRL may improve your 3G network service.
- **Load 3G PRL** – for example, you've received via email or downloaded a file.

Alternatively, you can check online for a PRL update – in **Advanced settings > WAN > Setup**, click **Update 3G PRL**.

Resetting the 3G/4G Configuration to Default Settings

Note: Reset the configuration only if instructed by a Sprint representative.

After a configuration reset:

- You must go through the device setup (page 20) and 3G activation. (The latter starts automatically.)
- Any changes you've made to the settings are lost.

1. Log in to the home page.
2. Click **Advanced settings > Device > About**.
3. Click **Reset Device to Factory Defaults**.
4. When prompted, enter the SPC (Service Programming Code). (If you don't know your SPC, contact Sprint.)

You won't be able to establish a data connection until you:

1. Go through the device setup (page 20).
2. Go through 3G activation or, if using 4G, use pay-as-you-go.

- ◆ [Setting the GPS Mode \(page 93\)](#)
- ◆ [Setting the GPS Fix Rate \(page 94\)](#)
- ◆ [Using Metric Units \(page 94\)](#)
- ◆ [Changing Your Mapping Service \(page 94\)](#)
- ◆ [Performance Setting \(GPS\) \(page 94\)](#)
- ◆ [Accuracy \(page 95\)](#)

Basic GPS settings can be changed in the GPS Information and Settings window. See “GPS Information and Settings” on page 44.

Additional settings are available at **Advanced settings > WAN > GPS**.

Setting the GPS Mode

GPS mode determines whether the location fix is done:

- Once (“one-time”), or
- Periodically (“continuous”) – used, for example, for navigation/turn-by-turn (TBT) applications.

To set the GPS mode:

1. Ensure you’re logged in to the home page.
2. Click **Advanced settings > WAN > GPS**.
3. If the **Enable GPS** check box is not selected, select it.
4. Select one of the following:
 - **One-time** – Use a single fix. Use this option if you’ll be using your device at the same location.

Tip: If you want to get a fix now, click **Get fix now**.

- **Continuous** – Obtain fixes on a regular basis. Also known as auto-tracking. Useful for navigation or turn-by-turn (TBT) applications (for example, driving directions).

Setting the GPS Fix Rate

The GPS fix rate determines how often GPS fixes are obtained. This option is available only if the fix mode (**GPS Mode**) is set to **Continuous**.

1. Log in to the home page.
2. Click **Advanced settings > WAN > GPS**.
3. Ensure **GPS Mode** is set to **Continuous**.
4. In the **Fix Rate** field, enter a number between 1 and 999 (seconds). (The smaller the number, the more up-to-date the location tracking will be, at the cost of shorter battery life of the device.)

Using Metric Units

To use metric units in the display of location information (for example, speed and altitude):

1. Ensure you're logged in to the home page.
2. Click the GPS icon  (on the left side of the home page).
3. In the GPS Information and Settings window, select the **Metric units** check box.

Changing Your Mapping Service

To change the mapping service (for example, Google Maps or MapQuest) that displays the GPS results (in a separate browser window):

1. Ensure you're logged in to the home page.
2. Click the GPS icon  (on the left side of the home page).
3. Click a service in the **Mapping service** list (in the GPS Information and Settings window).

Performance Setting (GPS)

The performance setting determines the amount of time the device waits for a satellite to be discovered when obtaining GPS information.

1. Log in to the home page.
2. Click **Advanced settings > WAN > GPS**.
3. In the **Performance Value** section, select one of the following:
 - **Automatic** – The device automatically determines the most appropriate setting to use.
 - **Manual** – In the input field, enter the number of seconds the device should wait for a satellite to be discovered. If this time is exceeded, an error is reported.

Accuracy

The accuracy setting determines how accurate the location information is.

1. Log in to the home page.
2. Click **Advanced settings > WAN > GPS**.
3. In the **Accuracy** section, select one of the following:
 - **Automatic** – The device automatically determines the most appropriate setting to use.
 - **Manual** – In the input field, enter the number of meters to which the data must be accurate.
Note: If the value is very small (i.e. very high accuracy), the fix may fail.

Configuring the Router Tab

- ◆ Basic Panel (page 96)
 - ◆ LAN Panel (page 97)
 - ◆ Port Forward Panel (page 101)
 - ◆ Port Trigger Panel (page 103)
 - ◆ DMZ Panel (page 104)
 - ◆ Resetting the Software to Default Settings (page 105)
1. Log in to the home page.
 2. Click **Advanced settings** (🔍).
 3. Click **Router**.
 4. Depending on the settings you want to configure, click one of the panels:
 - **Basic**. See “Basic Panel” on page 96.
 - **LAN**. See “LAN Panel” on page 97.
 - **Port Forward**. See “Port Forward Panel” on page 101.
 - **Port Trigger**. See “Port Trigger Panel” on page 103.
 - **DMZ**. See “DMZ Panel” on page 104.

Basic Panel

To access this panel:

1. Log in to the home page.
2. Click **Advanced settings** (🔍).
3. Click **Router > Basic**.

From this window, you can enable or disable these features, and perform these actions:

- **Port forwarding**. See “Port Forward Panel” on page 101.
- **Port triggering**. See “Port Trigger Panel” on page 103.
- **DMZ**. See “DMZ Panel” on page 104.
- **UPnP** (universal plug and play). See “UPnP (Universal Plug and Play)” on page 97.
- **SPI** (stateful packet inspection). See “SPI (Stateful Packet Inspection)” on page 97.
- **Router Settings Reset**. See “Resetting the Software to Default Settings (Through the Browser Interface)” on page 107.

UPnP (Universal Plug and Play)

UPnP provides simple and robust connectivity among consumer electronics, intelligent appliances, and mobile devices from many different vendors. For more information, see www.upnp.org.

Note: If UPnP is enabled, there are potential security risks.

Enabling UPnP

Before you can use UPnP, you must enable it.

1. Log in to the home page.
2. Click **Advanced settings > Router > Basic**.
3. Next to **UPnP**, select **Enable**.

SPI (Stateful Packet Inspection)

SPI, also known as “dynamic packet filtering,” helps to prevent cyberattacks by validating that the traffic passing through a session conforms to the protocol used for this type of session. Packets that are not conforming get rejected.

Enabling SPI

Before you can use SPI, you must enable it.

1. Log in to the home page.
2. Click **Advanced settings > Router > Basic**.
3. Next to **SPI**, select **Enable**.

LAN Panel

1. Log in to the home page.
2. Click **Advanced settings** (🔑).
3. Click **Router > LAN**.

From this window, you can view or adjust these settings, or perform the following actions:

- **Router IP Address** – The routing hardware’s IP address on the LAN.
- **Subnet Mask** – The routing hardware’s internal LAN subnet mask.
- **Hostname** (device name) – See “Host Name (Device Name)” on page 89.
- **SSID** (Wi-Fi network name) – See “SSID (Wi-Fi Network Name)” on page 83.
- **Link SSID and Hostname** – See “Linking the SSID and the Host Name” on page 84.
- **DHCP Server** (enable DHCP)

Note: The following settings are displayed only when DHCP is enabled.

- **DHCP IP Address Range** – The starting and ending address of the range of IP addresses available for the device to dynamically (that is, not permanently) assign to computers connected to it.
- **DHCP Lease Time** – Amount of time, in minutes, a computer can use its assigned IP address before it is required to renew the lease. After this time is up, the computer is automatically assigned a new dynamic IP address.

Enter a number between 2 and 10080.

- **Max DHCP Clients** – The number of DHCP addresses that can be assigned and active at one time. It's recommended you set this to a number greater than the number of Wi-Fi users.
- **DNS Mode** – Specifies how the DNS servers (that the DHCP clients are to communicate with) are obtained.

- **Auto:** Use the DNS server specified by Sprint. **DNS Relay** is enabled by default.

- **Manual:** The routing hardware assigns DHCP clients the DNS servers specified in the **Manual DNS Server #1** and **#2** fields.

Use this option to access a DNS server that provides customized addressing or if you have a local DNS server on your network.

If **DNS Relay** is disabled, the routing hardware rejects DNS requests targeting the internal DNS proxy.

- Static IP addresses to use for the DNS servers (if **DNS Mode** is Manual). (**Manual DNS Server #1** and **#2**)

Available only if **DNS Mode** is Manual.

- **DNS Relay** – If enabled, and if **DNS Mode** (see above) is Manual, the routing hardware assigns DHCP clients the DNS servers specified in the **Manual DNS Server #1** and **#2** fields.

If disabled, the routing hardware rejects DNS requests targeting the internal DNS proxy.

The **DNS Relay** field is configurable and displayed only if **DNS Mode** is Manual. If **DNS Mode** is Auto, DNS Relay is enabled by default.

- Assign a permanent IP address to a MAC address, and view the static IP assignment list. See “DHCP Static IP Assignment List” on page 99.

DHCP

DHCP (Dynamic Host Control Protocol) automatically assigns an IP address to each device on the network and manages other network configuration information for devices connected to your network. You do not need to manually configure the IP address on each device that's on your network.

The assigned IP addresses are not permanent (as opposed to when using static IP).

Most ISPs (Internet Service Providers) use DHCP.

Normally, you should enable DHCP, in which case you must configure each device on the network with one of the following:

- TCP/IP settings set to “Obtain an IP address automatically”.
- TCP/IP bound to the Ethernet connection with DHCP.

If DHCP is disabled, you must configure each device on the network with:

- Fixed (permanent/static) IP address.
- DNS server addresses (provided by Sprint).

Enabling DHCP

1. Log in to the home page.
2. Click **Advanced settings > Router > LAN**.
3. Next to **DHCP Server**, select **Enable**.

Configuring DHCP

To configure DHCP settings, DHCP must be enabled (**Advanced settings > Router > LAN > DHCP Server**).

You can set the following DHCP settings in **Advanced settings > Router > LAN**:

- **DHCP IP Address Range** – The starting and ending address of the range of IP addresses available for the device to dynamically (that is, not permanently) assign to computers connected to it.
The start address must be 192.168.0.10 or above.
The ending address must be 192.168.0.50 or below.
- **DHCP Lease Time** – Amount of time, in minutes, a computer can use its assigned IP address before it is required to renew the lease. After this time is up, the computer is automatically assigned a new dynamic IP address.
Enter a number between 2 and 10080.
- **Max DHCP Clients** – The number of DHCP addresses that can be assigned and active at one time. It's recommended you set this to a number greater than the number of Wi-Fi users.
- **DNS Mode** – Specifies how the DNS servers (that the DHCP clients are to communicate with) are obtained. See "DNS Mode" on page 101.
- Assign a permanent (static) IP address to a device on your network, and view the static IP assignment list. See "DHCP Static IP Assignment List" below.

DHCP Static IP Assignment List

With DHCP, IP addresses are assigned dynamically; devices typically don't have a permanent IP address.

However, in some cases you might want to assign a static (permanent) IP address to a device, while still using DHCP for the rest of the devices on your network. This is also known as "DHCP reservation." You might want to do this with, for example, a Web server, FTP server, media server.

Viewing the Static IP Assignment List

1. Log in to the home page.
2. Click **Advanced settings > Router > LAN**.
3. Ensure DHCP is enabled (**DHCP Server**).
4. Click **DHCP Static IP Assignment List**.

Assigning an IP Address Based on a MAC Address

1. Follow the above steps to display the DHCP Static IP Assignment List window.
2. In the **Hostname** field, enter a meaningful description of the device.
3. In the **MAC Address** field, enter the MAC address of the device. (If you don't know this address, see "Finding the MAC Address" on page 122.)
4. In the **IP Address** field, enter the IP address you want to assign to the device.
5. Select the **Enable** check box to have the device use the designated IP address.
6. Click **Add**.
7. Click **save**.

Removing an IP Address Based on a MAC Address

1. Click **DHCP Static IP Assignment List** on the **LAN** panel of the **Router** tab.
2. To keep the device information in the list (in case you want to re-enable DHCP for this MAC address later on), clear the **Enable** check box.

– or –

To remove the device from the list:

- Click the row that you want to remove.
A row of buttons (**Delete**, **OK**, **Cancel**) appears.
- Click **Delete**.

DNS Mode

The **DNS Mode** setting specifies how the DNS servers (that the DHCP clients are to communicate with) are obtained.

1. Log in to the home page.
2. Click **Advanced settings** (🔑).
3. Click **Router > LAN**.
4. Set **DNS Mode** to one of the following:
 - **Auto**: Use the DNS server specified by Sprint. **DNS Relay** is enabled by default.
 - **Manual**: The routing hardware assigns DHCP clients the DNS servers specified in the **Manual DNS Server #1** and **#2** fields.
Use this option to access a DNS server that provides customized addressing or if you have a local DNS server on your network.
If **DNS Relay** is disabled, the routing hardware rejects DNS requests targeting the internal DNS proxy.

For information on DNS Relay, see “LAN Panel” on page 97.

Port Forward Panel

Normally, incoming traffic (from the Internet) is blocked. However, port forwarding lets you forward incoming traffic to specific ports and devices (per their local IP address) on your network. For example, you can configure port forwarding so that:

- You can access your Remote Desktop from the Internet (by specifying the WAN [public] IP address that the device is using).
- Internet users can access a Web, FTP, or email server, or gaming or Internet application hosted by your computer.

Note: Port forwarding creates a security risk. When not required, port forwarding should be disabled. Port forwarding does not apply to normal browsing, file downloading, running most online games or other applications hosted on the Internet. (Some online games require port forwarding.)

Before you can use or configure port forwarding, you must enable it, as explained in “Enabling Port Forwarding” on page 102.

From the **Port Forward** panel of the **Router** tab of the **Advanced Settings** window, you can:

- Enable port forwarding for an application. See “Enabling Port Forwarding for an Application” on page 102.
- Remove an application from the port forwarding list. See “Disabling Port Forwarding for an Application” on page 102.

Enabling Port Forwarding

Before you can use or configure Port Forwarding, you must enable it.

1. Log in to the home page.
2. Click **Advanced settings > Router > Basic**.
3. Next to **Port Forwarding**, select **Enable**.
4. Click **save**.

Enabling Port Forwarding for an Application

1. Ensure you've enabled port forwarding. See "Enabling Port Forwarding" on page 102.
2. Click **Advanced settings > Router > Port Forward**.
3. In the last row of the table, click the **Application** field, and select the application type from the list.
The values for **Start** and **End** ports are automatically filled in.
4. If necessary, change the range of port numbers associated with the application. Traffic will be allowed (not blocked) if its destination port number is in the specified range.
 - In the **Start** field, enter the number that starts the port range.
 - In the **End** field, enter the number that ends the port range.
If the range consists of only one port, enter the number that you entered in the **Start** field.
5. In the **Protocol** list, click the protocol(s) used for this application (TCP, UDP, or both).
6. In the **IP Address** field, enter the IP address of the server to be accessed.
7. Ensure **Enable** is selected.
8. Click **Add**.
9. Click **save**.

Disabling Port Forwarding for an Application

1. Ensure you've enabled port forwarding. See "Enabling Port Forwarding" on page 102.
2. Click **Advanced settings > Router > Port Forward**.
3. To keep the application in the list (in case you want to re-enable port forwarding later on), clear the **Enable** check box.
– or –
To remove the application from the list:
 - Click the row that you want to remove.
A row of buttons (**Delete**, **OK**, **Cancel**) appears.
 - Click **Delete**.

Port Trigger Panel

Some applications require multiple ports open for communication, many of which may be initiated by a computer on the WAN. Examples of this include video conferencing, VoIP (Internet telephony), and Internet gaming.

With port triggering, the device monitors outgoing data on specific port numbers (trigger ports). The device keeps track of the IP address of the computer that sends data on these trigger ports, so that when incoming data on the Forward ports arrives, the device sends the incoming data to the same computer.

Before you can use or configure port triggering, you must enable it, as explained in “Enabling Port Triggering” below.

From the **Port Trigger** panel of the **Router** tab of the **Advanced Settings** window, you can:

- Enable port triggering for specified protocols and ports. See “Enabling Port Triggering for Specified Protocols and Ports” below.
- Remove protocols and ports from the port triggering list. See “Removing Ports From the Port Triggering List” on page 104.

Enabling Port Triggering

Before you can use or configure Port Triggering, you must enable it.

1. Log in to the home page.
2. Click **Advanced settings > Router > Basic**.
3. Next to **Port Triggering**, select **Enable**.

Enabling Port Triggering for Specified Protocols and Ports

1. Ensure you've enabled port triggering. See “Enabling Port Triggering” (above).
2. Click **Advanced settings > Router > Port Trigger**.
3. In the last row of the table, in the first **Protocol** list, click the protocol(s) used by the application for outgoing traffic (to the Internet, sent through the trigger ports).
4. In the **Trigger Ports** field, enter the port number(s) used to determine that the application is in use (that is, specify the port number or range of port numbers that the application uses for outgoing traffic). (Check the user documentation for the application.)
To specify a range of port numbers, separate the start and end port number with a hyphen.
5. In the second **Protocol** list, click the protocol(s) used by the application for incoming traffic (from the Internet).
6. In the **Forward Ports** field, enter the ports to forward to the computer that triggered the rule (that is, specify the port number or range of port numbers that the application uses for incoming traffic). (Check the user documentation for the application.)
7. To specify a range of port numbers, separate the start and end port number with a hyphen.
8. Ensure **Enable** is selected.

9. Click **Add**.
10. Click **Save**.

Removing Ports From the Port Triggering List

1. Ensure you've enabled port triggering. See "Enabling Port Triggering" on page 103.
2. Click **Advanced settings > Router > Port Trigger**.
3. To keep the entry in the list (in case you want to re-enable this entry later on), clear the **Enable** check box.

– or –

To remove the entry from the list:

- Click the row that you want to remove.
A row of buttons (**Delete**, **OK**, **Cancel**) appears.
- Click **Delete**.

DMZ Panel

DMZ stands for "demilitarized zone." You can select one computer to receive all unsolicited incoming connections.

The IP address of the DMZ is the default recipient of incoming packets (from the Internet) that are not handled by port forwarding rules, port triggering rules, or NAT'd connections:

1. If port forwarding, port triggering, or both are enabled, incoming traffic is routed according to the port forwarding rules, port triggering rules, or NAT'd connections.
2. If incoming traffic was not routed as a result of the above:
 - If DMZ is enabled, then incoming traffic is routed to the computer that uses the IP address specified by the DMZ settings.
 - If DMZ is not enabled, the incoming traffic is blocked.

Note: Putting a computer in the DMZ opens all the ports of that computer, and exposes that computer to various security risks. Use this option only as a last resort – if possible, use other options instead (for example, port forwarding or port triggering).

Enabling DMZ

Before you can use or configure DMZ, you must enable it.

1. Log in to the home page.
2. Click **Advanced settings > Router > Basic**.
3. Next to **DMZ**, select **Enable**.
4. Click **Save**.

Configuring DMZ

1. Ensure you've enabled DMZ. See "Enabling DMZ" on page 104.
2. Click **Advanced settings > Router > DMZ**.
3. Specify the computer that you want exposed to the Internet: in the **Destination IP Address** field, enter the IP address of the computer. (If you don't know how to find the IP address, see "Finding the IP Address" on page 123.)
4. In the **Source IP Address** section, specify what incoming traffic (not handled by port forwarding, port triggering, or NAT) to forward to this computer.

To forward all incoming traffic, click **Any**.

– or –

To forward incoming traffic from certain IP addresses:

■ Click **Restriction**.

■ In the two additional fields that are displayed, enter the start and end IP addresses of a range.

5. Using the DHCP Static IP Assignment List, assign an IP address based on the MAC address of the computer that is in the DMZ. See "Assigning an IP Address Based on a MAC Address" on page 100.

– or –

On the computer that is in the DMZ, disable DHCP, and manually assign the IP address, gateway, and DNS server.

Resetting the Software to Default Settings

WARNING: If you reset the software to default settings:

- You must go through the device setup (page 20), as if you've just purchased the device.
- Any changes you've made to the settings are lost.

Your 3G and 4G account information is not affected; after reset, the device remains provisioned for service.

You'll need to reset the software to default settings if:

- You've forgotten the administrator password.
- You've changed the DHCP settings such that the device is inoperable (for example, there's no communication with the device).

You have two options to initiate the reset:

- Through the software. See "Resetting the Software to Default Settings (Through the Browser Interface)" on page 107.
- Through the reset button on the device. See the following section.

Resetting the Software to Default Settings (Through the Reset Button)

1. Remove the battery compartment cover from the device.

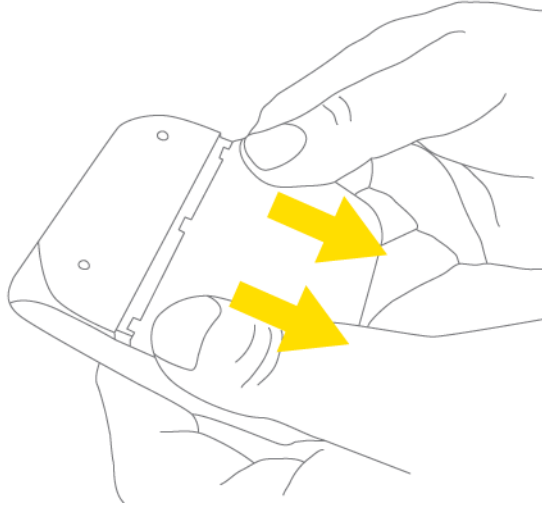

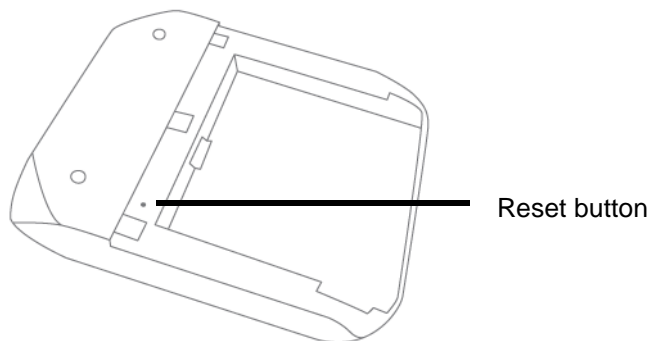

2. Find the small hole below and to the right of the battery compartment. The reset button is inside this hole.

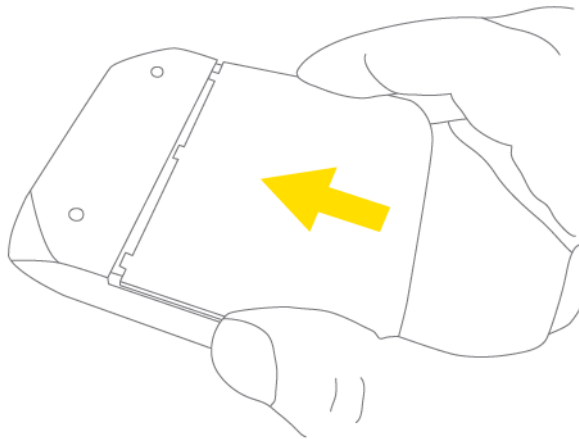

3. Insert a thin object (for example, the end of a paper clip) into the hole, and lightly press on the bottom of the hole **for five or more seconds**.

4. Replace the battery compartment cover.





5. Check the device LCD. If it displays “Reset to factory defaults? Press  to accept,” press the power button  on the device.
6. Follow the instructions on the device LCD.

Resetting the Software to Default Settings (Through the Browser Interface)

WARNING: If you reset the software to default settings:

- You must go through the device setup (page 20), as if you’ve just purchased the device.
 - Any changes you’ve made to the settings are lost.
- Your 3G and 4G account information is not affected; after reset, the device remains provisioned for service.

1. Log in to the home page.
2. Click **Advanced settings > Router > Basic**.
3. Click **Router Settings Reset**.
4. Check the device LCD. If it displays “Reset to factory defaults? Press  to accept,” press the power button  on the device.
5. Follow the instructions on the device LCD.

Exporting and Importing Settings

- ◆ Exporting Settings (page 108)
- ◆ Importing Settings (page 108)

Exporting Settings

Settings include configuration information for the device, network, and browser interface.

You can, for example, save the current configuration, then make some changes and test them. You can then use the **Import** button to restore (load) the saved configuration.

To export the settings to a text file:

1. Log in to the home page.
2. Click **Advanced settings > Device > Basic**.
3. Click **Export**.

Importing Settings

1. Log in to the home page.
2. Click **Advanced settings > Device > Basic**.
3. Browse to and click the file with the saved settings.
4. Click **Import**.

Note: Your device may reset, and you may need to reconnect to Wi-Fi and the Internet. See “How Do I Connect to Wi-Fi?” on page 116 and “Launching Your Network Connection” on page 38.

- ◆ Logs Available (page 109)
- ◆ Connection History (page 109)
- ◆ System Events (page 110)
- ◆ Setting the Method Used for Time Acquisition (page 111)

Logs Available

The following types of logs are available:

- Connect/disconnect. See the following section.
- System events. See “System Events” on page 110.

Connection History

The connection history shows the time of connections to and disconnections from the Internet.

Note: The connection history does not log the amount of data transferred. In the Internet Connection Information window, you can view information on the current billing cycle and lifetime of the device; see “Internet Connection Information” on page 47.

Enabling and Disabling Logging of Connect/Disconnects

1. Log in to the home page.
2. Click **Advanced settings > Device > Log**.
3. In the **Connect/Disconnect** section, select **Enable** or **Disable**.
4. Click **save**.

Exporting the Connection History

1. Log in to the home page.
2. Click **Advanced settings > Device > Log**.
3. Ensure **Connect/Disconnect** is set to **Enable**.
4. Click **Export**.

Clearing the Connection History

1. Log in to the home page.
2. Click **Advanced settings > Device > Log**.
3. In the **Connect/disconnect** section, click **Clear log**.

System Events

You can enable or disable, as a group, the logging of the following events:

- Software update available
- Network update available
- Primary WAN failover
- Primary WAN switchback
- Unexpected data connection loss
- Changes to miscellaneous settings

The following system events are always logged:

- Intrusion alerts
- Unexpected power loss
- Critical battery
- Critical temperature
- Routing hardware settings reset
- Firmware update

Enabling and Disabling Logging of System Events

1. Log in to the home page.
2. Click **Advanced settings > Device > Log**.
3. In the **System Events** section, select **Enable** or **Disable**.
4. Click **save**.

Note: Certain events are always logged; see "System Events" (above).

Exporting System Events

1. Log in to the home page.
2. Click **Advanced settings > Device > Log**.
3. Ensure **System Events** is set to **Enable**.
4. Click **Export**.

Clearing the System Events Log

1. Log in to the home page.
2. Click **Advanced settings > Device > Log**.
3. Ensure **System Events** is set to **Enable**.
4. Click **Clear log**.

Setting the Method Used for Time Acquisition

Time information is stored in the connection history log and system events log.

To set the method used for obtaining the time:

1. Log in to the home page.
2. Click **Advanced settings > Device > Log**.
3. Select the **3G** or the **NTP** check box.
 - **3G** – Time information is obtained from the 3G (CDMA) network; this is more accurate than NTP, but requires 3G coverage.
 - **NTP** – The device's clock is synchronized to a Network Time Protocol server on the Internet; not as accurate as when using the **3G** setting, but doesn't require 3G coverage. Use this setting if you have 4G but no 3G coverage.

Section 5M

Setup Pages

- ◆ Welcome to Your Device Window - Select an Option (page 112)

Welcome to Your Device Window - Select an Option

The Welcome to Your Overdrive window opens:

- Automatically, as part of the initial setup of your newly purchased device.
- When you click **Admin Setup** (🌐) from the home page (you must be logged in).

Note: This window displays the administrator password and the address of the device home page. Please remember this information or write it down in a safe place.

This window provides several options.

- To keep the default settings of the device, select one of the following:
 - **The Internet** (to start surfing)
 - **My Overdrive's home page** (to view the device status, customize settings).
- To change security settings, select **Set up my Overdrive**.

Section 6

Resources



Section 6A

More Information

- ◆ Visiting the Sprint Website (page 114)
- ◆ Contacting Customer Service (page 114)
- ◆ Online Help (page 114)

Visiting the Sprint Website

Sign on to www.sprint.com to get up-to-date information on Sprint services, options, and more.

You can also:

- Review coverage maps.
- Access your account information.
- Add additional options to your service plan.
- Purchase accessories.
- Check out frequently asked questions.
- And more.

Contacting Customer Service

You can reach Sprint Customer Service by:

- Logging on to your account at www.sprint.com.
- Calling us toll-free at **1-800-927-2199** (business use) or **1-888-211-4727** (personal use).

Online Help

In the browser interface, click **Help**  and, from the menu, select **Online Help**.

The Help system opens in a new Web browser window or tab.

You have several options to find the information you need:

- Browse the Table of Contents.
- Use the Index or Search feature: click the appropriate button in the lower left part of the help window, and type the information you're looking for.

Other Ways to View Help Information

- Some windows have a  icon. Click the icon to view Help information.
- When you move the cursor over a field or button in **Advanced Settings**, help information, if available, appears to the right of the window.

Contextual Help in the Advanced Settings Window

When you move the cursor over a field or button in **Advanced Settings**, help information on this item, if available, appears to the right of the window.

To turn this feature on or off:

1. Ensure you're logged in to the home page.
2. Click **Advanced settings > Device > Basic**.
3. Set **Help for Advanced Settings** to **Show** or **Hide**.
4. Click **Save**.



Section 6B

Frequently Asked Questions

- ◆ How Can I Tell I'm Connected to 3G/4G? (page 116)
- ◆ How Do I Connect to Wi-Fi? (page 116)
- ◆ Is Roaming on 4G Supported? (page 117)
- ◆ What Do I Do if I Forgot the Wi-Fi Password? (page 117)
- ◆ What Do I Do if I Forgot the Administrator Password? (page 117)
- ◆ If the Connection is "Always On," Am I Always Being Billed? (page 117)
- ◆ Questions About GPS and Sprint Location Services (page 117)
- ◆ How Do I Access My Corporate Network Through a VPN? (page 118)
- ◆ Are Terminal Sessions Supported? (page 118)

How Can I Tell I'm Connected to 3G/4G?

When you're connected:

- The 3G or 4G icon (on the left side of the home page) is solid. For example, .
- The bottom area of the device LCD, the Virtual Device, and the Mini Window show the data transfer icon  and data transfer information (amount of data; connection duration).

How Do I Connect to Wi-Fi?

You may have to manually connect to Wi-Fi after certain events – for example, as part of the initial device setup, or after a software update.

Tip: The Wi-Fi network name is displayed on the device LCD.

To connect to Wi-Fi:

1. Do one of the following, depending on your operating system.

Windows

Windows 7: Right-click the  icon in the system tray.

Windows Vista: Click **Control Panel > Network and Internet > Network and Sharing Center > Connect to a network.**

Windows XP: Click **Control Panel > Network Connections > Wireless Network Connections > View available wireless networks.**

Mac

Click the AirPort icon  (in the upper right corner of your screen).

Linux

Please see the user documentation of the Linux distribution.

Other operating systems

Please see the user documentation for your operating system or computer.

2. Select the Wi-Fi network provided by the Overdrive 3G/4G Mobile Hotspot and connect to it. (If prompted for a network key/security key/password, enter the Wi-Fi password.)

Is Roaming on 4G Supported?

At the time of this release, roaming on 4G is not supported.

What Do I Do if I Forgot the Wi-Fi Password?

- If the Wi-Fi Password Reminder feature is enabled, display the password on the device. See “Wi-Fi Password Reminder” on page 86.
- Connect the device to your computer through USB, then log in and view the Wi-Fi password (in **Advanced settings > Wi-Fi > Security**). Write the password down in a safe place. See “Connecting Through USB” on page 10.

Note: If you've forgotten both the Wi-Fi password and the administrator (login) password, then you must reset the software to default settings. See “Resetting the Software to Default Settings” on page 105.

What Do I Do if I Forgot the Administrator Password?

1. Reset the software to default settings. See “Resetting the Software to Default Settings” on page 105.
2. Go through the device setup, during which the administrator password will be displayed; write it down in a safe place. See “Setting Up the Device” on page 20.

If the Connection is “Always On,” Am I Always Being Billed?

No. The connection to the network goes dormant after a period of inactivity, but the connection can be re-established faster than having to reconnect. Billing occurs only when data is passed across the network.

Questions About GPS and Sprint Location Services

What is LBS?

LBS (Location-Based Services) is used to provide enhanced Local Search feature via internet mapping services. For more information, see “Performing a Location Search” on page 57.

What is GPS?

GPS stands for Global Positioning System, which is a system that uses a series of 24 geosynchronous satellites to provide location data.

GPS satellites transmit signals to equipment on the ground. GPS receivers passively receive satellite signals, but do not transmit.

What is Enhanced Local Search?

Enhanced Local Search is a quick, easy method to run, via the browser interface, local search queries to find locations and directions to locations and businesses.

The enhanced Local Search feature uses LBS and allows you to search for Sprint stores, restaurants, banks, hotels, and so on. For more information, see “Performing a Location Search” on page 57.

How Do I Use the Enhanced Local Search Feature?

See “Performing a Location Search” on page 57.

Where Can I Use GPS?

GPS works wherever you have line-of-sight access to the GPS satellites.

How Do I Enable or Disable GPS?

By default, Sprint Location Services are disabled. To enable Sprint Location Services, see “Enabling GPS” on page 56.

Location-Based Services Limitations

Weather conditions may affect your ability to get a clear view of the satellites and thus to acquire a GPS fix.

How Do I Access My Corporate Network Through a VPN?

Using Sprint Data Link

Sprint Data LinkSM is a network feature that allows you to directly connect to your corporate VPN.

With Data Link, you and your mobile workforce can maintain a secure, seamless VPN connection between your enterprise network and the advanced Sprint Mobile Broadband Network.

To learn more about Data Link, to arrange a connectivity solution that works for you, or to configure Data Link, please contact Sprint.

If You're Not Using Sprint Data Link

Once you complete a wireless connection, you may need to launch an extranet client provided by your company and supply the appropriate user name and password to gain access. For support, contact your company help desk.

Are Terminal Sessions Supported?

Terminal sessions (for example, via `telnet` or `ssh`) are not supported.

- ◆ Extending Battery Life (page 119)
- ◆ Device Location (page 120)
- ◆ Improving Signal Strength (page 120)
- ◆ Improving 3G Network Service (page 120)
- ◆ Improving Wi-Fi Performance (page 121)
- ◆ Security Tips (page 122)
- ◆ Finding the MAC Address (page 122)
- ◆ Finding the IP Address (page 123)

Extending Battery Life

- When you're not using the device, turn it off, or end the 3G/4G connection. (Click **Disconnect** on the home page.)
- Connect the device, through the USB to Micro B cable, to the AC charger or a computer, and disable Wi-Fi. See "Disabling Wi-Fi When Connected Through USB" on page 90.
- Adjust the LCD – do one or more of the following:
 - Turn off the LCD (**Advanced settings > Device > Display > LCD Backlight**).
 - Decrease the brightness of the LCD (**Advanced settings > Device > Display > Backlight Settings > On Battery/USB Power**).
 - Set the LCD to turn off sooner. See "Setting the LCD Timeout" on page 69.
- Configure the setting (for when battery powered or connected via USB) to "Better battery life" (**Advanced settings > Wi-Fi > Network > Battery or USB Powered**).
- Enable standby (low power) mode. See "Standby (Low Power) Mode" on page 46.
- Turn off the lighting of the power button  (i.e. LED) (**Advanced settings > Device > Display > Power Button LED**).
- Limit the number of Wi-Fi users (**Advanced settings > Wi-Fi > Network > Max Number of Users**).
- If you have 3G but not 4G coverage, set **WAN mode** to 3G only (**Advanced settings > WAN > Setup > WAN Mode**).
- If GPS is enabled and you're using your device from the same location, set **GPS Mode** to One-time. See "Setting the GPS Mode" on page 93.

Device Location

- Avoid moisture or extreme temperatures.
- For improved reception, place the device near a closed window.
- Place your device within easy reach of a reliable power supply and the computer to which it will be connected.

Improving Signal Strength

- Ensure you're inside the network coverage area.
- Try reorienting your device.
- Move the device and your computer to another location – you may be in or near a structure that is blocking the signal. Every obstacle (for example, walls, ceilings, furniture) between the Overdrive 3G/4G Mobile Hotspot and other wireless devices decreases the signal strength.
- Place the device in a centralized location, as high as possible in the room.
- Make sure there's plenty of space around your device to provide the best signal reception.
- Keep the device at least 3–6 feet away from electrical devices that generate RF interference (for example, microwaves, TVs, 2.4 GHz cordless phones, cellular phones, baby monitors, wireless speakers). If you're not using these electrical devices, turn them off.
- If possible, place your devices so that the signal passes through open doorways or drywall, as opposed to concrete, brick, metal, walls with insulation, and so on.
- If you cannot obtain service, contact Sprint – a network or account problem may be preventing you from obtaining service.

Improving 3G Network Service

To improve your network service, periodically check for PRL and profile updates.

The PRL (Preferred Roaming List) is an account configuration item set by your service provider. It controls the radio channels and network carrier used by the 3G modem.

To check for these updates:

1. Log in to the home page.
2. Click **Advanced settings** (.
3. Click **WAN > Setup**.
4. Click **Update 3G PRL**.
5. After the update checking is completed, click **Update 3G Profile**.

Improving Wi-Fi Performance

- Try a different channel number. See “Wi-Fi Channel” on page 90.
- Check whether any device updates are available. See “Updates” on page 58.
- See the tips in “Improving Signal Strength” on page 120.
- Limit the number of Wi-Fi users (**Advanced settings > Wi-Fi > Network > Max Number of Users**).
- Select a longer Wi-Fi range (**Advanced settings > Wi-Fi > Network > Longer Wi-Fi range** [two locations: **Battery or USB Powered**, and **AC Powered**]).

Windows XP Users

1. Open the Device Manager.
 - Click **start > Settings > Control Panel**.
 - Double-click **System**.
 - Click **Hardware**.
 - Click **Device Manager**.
2. Double-click **Network adapters**.
3. Double-click the Wi-Fi client network adapter of your computer – for example, “Intel(R) WiFi Link 5100 AGN” in the screenshot below.

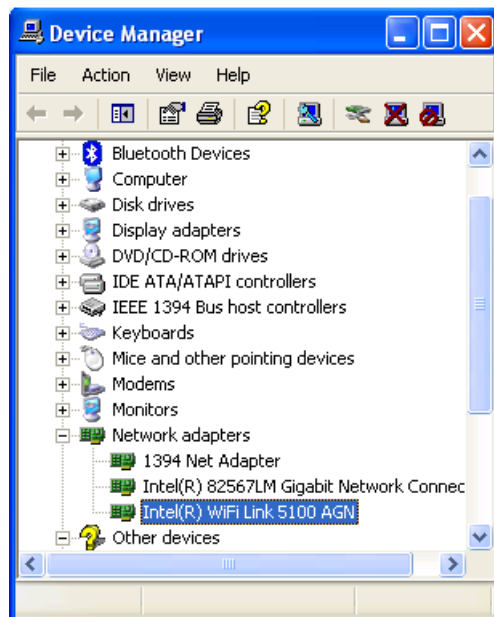

4. If the Wi-Fi client network adapter is by Intel, click **Advanced** and, in the **Property** list, click **Power Management** and move the slider all the way to the right (to **Highest**). Click **OK**.

– or –

If the Wi-Fi client network adapter is not by Intel, select a configuration with minimal power savings (to maximize throughput).

Note: The above settings are often controlled by 3rd-party value-add applications and may be automatically changed. If Wi-Fi performance improves for a while after performing the above steps, but then declines, recheck the above settings.

Security Tips

- Change the Wi-Fi network name (SSID) and Wi-Fi password on a regular basis. See “SSID (Wi-Fi Network Name)” on page 83 and “Wi-Fi Password” on page 86.
- Disable SSID Broadcast. See “Network Panel” on page 81.
- Use the highest level of Wi-Fi security that your devices support. See “Wi-Fi Security” on page 85.
- Change the login password. See “Changing the Administrator Password” on page 73.
- Use MAC filtering to specify computers that are or aren’t allowed to connect to the network. See “MAC Filter Panel” on page 82.

Finding the MAC Address

You’ll need to know the MAC address of a device, when performing any of the following:

- Assigning an IP address based on a MAC address (when using DHCP). See “DHCP Static IP Assignment List” on page 99.
- Allowing or denying computers access to the network. See “Allowing or Denying Computers Access to the Network” on page 87.

Tip: You can display a list of connected devices, including the MAC address of each device: click **List of connected devices**, available from **Advanced settings > Wi-Fi > MAC Filter** and **Advanced settings > Wi-Fi > Network**.

The steps to finding the MAC address of a device vary, depending on your operating system.

Windows

1. Open a command prompt window.
 - Click **Start** and **Run**.
 - Type **cmd** or **command**, and click **OK**.
2. At the command prompt, type **ipconfig/all** and press **Enter**.
3. Write down the Physical Address for the entry that relates to the wireless network connection; it appears as a series of numbers and letters – this is the MAC address of your wireless adapter.

Mac OS X

1. From the Apple menu () , select **System Preferences**.
2. Select **Network**.
3. Select the adapter that is connecting to the routing hardware.
4. Select **Advanced**.
5. Select **Ethernet**. The Ethernet ID is listed. This is the same as the MAC address.

Linux

Please see the user documentation of the Linux distribution.

Other operating systems

Please see the user documentation for your operating system or computer.

Finding the IP Address

You'll need to know the IP address of a device, when configuring any of the following:

- Port forwarding
- Port triggering
- DMZ
- Static DHCP features

To find the IP address of a device:

Windows

1. Open a command prompt window.
 - Click **Start** and **Run**.
 - Type **cmd** or **command**, and click **OK**.
2. At the command prompt, type **ipconfig** and press **Enter**.
3. Write down the IP Address for the entry that relates to the wireless network connection. (The IP address might be listed under "Ipv4 Address," or something similar.)

Mac OS X

1. From the Apple menu () , select **System Preferences**.
2. Select **Network**.
3. Select the wireless adapter. The IP address is displayed in the right pane.

Other operating systems

Please see the user documentation for your operating system or computer.

Section 6D

Troubleshooting Tips



- ◆ General Tips (page 124)
- ◆ LCD Is Dark (page 124)
- ◆ Insufficient Signal Strength (page 125)
- ◆ Messages Displayed on the Device LCD (page 125)
- ◆ Cannot Connect to Wi-Fi (page 127)
- ◆ Cannot Display the Home Page (page 127)
- ◆ Cannot Connect to the 3G/4G Network (page 129)
- ◆ Sprint Location Services Aren't Working or Don't Seem to Be Available (page 129)
- ◆ GPS Fix Not Available (page 129)
- ◆ Cannot Check for Updates (page 129)
- ◆ Sounds Are Enabled, but the Device Doesn't Generate Any Sounds (page 129)

General Tips

- Check the system events log. See “Exporting System Events” on page 110.
- If some settings are preventing you from connecting to Wi-Fi, connect to the device through the USB to Micro B cable, and then change the settings. See “Requirements for a USB Tethered Connection” on page 26 and “Making a Tethered Connection” on page 27.
- Go to www.sprint.com/support to access troubleshooting and other resources.
- The knowledge base at the Sierra Wireless website (www.sierrawireless.com/support/customer_help.aspx) may also be useful.

LCD Is Dark

The LCD is dark and is not displaying any text or icons if:

- The device is turned on and:
 - The LCD is turned off (**Advanced settings > Device > Display > LCD Backlight**).
 - The LCD is turned on, but the LCD is dormant (inactivity timeout). To make the LCD active, briefly press the power button  on the device.
 - The device is in standby (low power) mode. To exit this mode, briefly press the power button  on the device.
- The device is turned off.

To turn the device on:

- Ensure a battery is inserted into the device.
- Press the power button  on the device for approximately two seconds.

If the LCD is still dark, use the USB to Micro B cable to connect the device to the AC charger or to a computer.

Insufficient Signal Strength

If you have insufficient signal strength, the icon  is displayed (on the left side of the home page).

Insufficient signal strength may occur because:

- You are outside the network coverage area.
- Your device's internal antenna is pointing in the wrong direction.
- You are in or near a structure that is blocking the signal.
- You are near a device that is causing radio signal interference.
- A network or account problem is preventing you from obtaining service.

See also “Improving Signal Strength” on page 120.

Messages Displayed on the Device LCD

See also “SD Card Error” on page 36.

3G Activation Failed

1. Ensure you're in 3G coverage and the signal strength is strong.
2. Turn the device off and on. See “Turning Your Device Off” on page 14 and “Turning Your Device On” on page 13.
3. If the “Activation failed” message is still displayed, prepare the following, and contact Sprint:
 - Your billing information.
 - ESN of the device (displayed on the packaging, on the device [under the battery], and at **Advanced settings > Device > About**).

Connecting to 3G/4G



1. Check the signal strength. If it is weak, try the tips in “Improving Signal Strength” on page 120.
2. Try a different Connection Preferences setting. See “Mobile Broadband Information and Settings” on page 42.
3. Turn the device off and on. See “Turning Your Device Off” on page 14 and “Turning Your Device On” on page 13.
4. Update the 3G profile: click **Advanced settings > WAN > Setup > Update 3G Profile**.
5. If you're still unable to connect to 3G/4G, contact Sprint.

Connection Error

1. Log in to the home page.
2. Click **Advanced settings** (🔍).
3. Click **WAN > Setup > Update 3G Profile**.
4. If an error message and number are displayed on the LCD after the update, note the information and contact Sprint.

3G Activation Required

If the LCD displays this message, display the 3G Activation Required alert and start the activation:

1. Ensure you're logged in to the home page.
2. Click the alerts icon  to display the alert window.
3. If more than one alert is available, use the  and  buttons (at the top of the alert window) to browse to the alert.
4. In the 3G Activation Required alert window, click **Activate now**.

Tip: Alternatively, click **Advanced settings > WAN > Setup > Update 3G Profile**.

Searching for Network

The LCD displays this message until a 3G or 4G network is acquired.

If this message persists, see the tips in “Cannot Connect to the 3G/4G Network” on page 129.

Update Failed

If this message appears on the device LCD or in the 3G Network Update Available or Software Update Available alert windows (after you've attempted the update):

1. Ensure your device is connected to the AC charger or computer, through the USB to Micro B cable.

Note: If you'll be using USB for data transfer (and not just for charging the device), you must install the device driver. See “Making a Tethered Connection” on page 27.

2. Retry the update.
3. If the “Update failed” message is still displayed, contact Sprint.

Cannot Connect to Wi-Fi

If your computer cannot connect to the Wi-Fi network of the Overdrive 3G/4G Mobile Hotspot, ensure that:

- The maximum number of Wi-Fi users has not been reached. (To determine the number of connected Wi-Fi users and set the maximum, see “Wi-Fi Users Information and Settings” on page 45.)
- You’re connecting to the correct Wi-Fi network (SSID), and you’re using the correct Wi-Fi password. If the Wi-Fi Password Reminder feature is enabled (page 86), you can use it to display the SSID and Wi-Fi password on the device LCD.
- Nobody has changed the name or password of the Wi-Fi network. If the Wi-Fi Password Reminder feature is enabled (page 86), you can use it to display the SSID and Wi-Fi password on the device LCD.
- Nobody is connected through the USB to Micro B cable when **Disable Wi-Fi when connected via USB** is selected.
- Your computer supports the type of Wi-Fi security that the network is set to use.

Note: All the devices used with the Overdrive 3G/4G Mobile Hotspot must support the selected security type.

- Your computer supports Wi-Fi 802.11g (if **Basic Rate** is set, in **Advanced settings > Wi-Fi > Network**, to **802.11b/g compatibility**)).
- Your computer has not been blocked, through MAC filtering. See “Specifying Computers That Are Not Allowed to Access the Network” on page 88.

Tip: If some settings are preventing you from connecting to Wi-Fi, connect to the device through the USB to Micro B cable, and then change the settings. See “Requirements for a USB Tethered Connection” on page 26 and “Making a Tethered Connection” on page 27.

Cannot Display the Home Page

Your Web browser may display an error message when you try to display the home page. The error message depends on your Web browser.

- “Could not connect to remote server” (Opera)
- “Internet Explorer cannot display the webpage” (Internet Explorer)
- “Oops! This link appears to be broken” (Google Chrome)
- “Safari can’t open the page” (Safari)
- “The connection has timed out” (FireFox)

Check the following:

- The device is turned on. See “Turning Your Device On” on page 13.
- You have established a connection to the device (through Wi-Fi or through the USB to Micro B cable).
- Ensure you’re typing the correct address in the Web browser.
 - Try **http://<SSID>**, where <SSID> is as displayed on the device LCD.
 - If the home page is still not displayed, try **http://192.168.0.1** or, if you’re using custom routing settings, replace “192.168.0.1” with the appropriate IP address.
- The Web browser is a recent version, and Java-enabled. The following are recommended:
 - Internet Explorer (version 6.0 or higher)
 - Mozilla Firefox (version 2.0 or higher)
 - Google Chrome (version 2.0.172.28 or higher)
 - Apple Safari (version 2.0 or higher)
 - Opera version 9.64
- If your computer has other adapters (for example, Ethernet) connected to other networks, disable or remove them from your computer.
- If Internet security software is running on your computer, disable it and see whether the error message still occurs. Some firewall software may block access to the home page.
- If DHCP is enabled on the device, ensure DHCP is enabled on your computer. See “DHCP” on page 98.
- Check your Web browser settings.
 - Open the Control Panel in Windows.
 - Double-click **Internet Options**.
 - From the **Security** tab, restore the default settings.
 - From the **Connections** tab, select **Never dial a connection**.
 - From the **Advanced** tab, restore the default settings.
 - Close and reopen your Web browser.
- Disconnect the device from your computer (if you’re using the USB to Micro B cable). Remove the battery from the device. Reinsert the battery.

If, after checking all of the above, you still cannot display the home page, consider resetting the software to default settings. See “Resetting the Software to Default Settings” on page 105.

Cannot Connect to the 3G/4G Network

- Ensure your computer is connected to the device (through the USB to Micro B cable or Wi-Fi). See “How Do I Connect to Wi-Fi?” on page 116 or “Making a Tethered Connection” on page 27.
- Try the tips in “Improving Signal Strength” on page 120.
- Check the **WAN Mode** setting (**Advanced settings > WAN > Setup**). For example, if it’s set to **4G only**, you won’t be able to connect if:
 - You have 4G coverage, but you’re roaming.
 - You don’t have 4G coverage.
- If you’re roaming, ensure that 3G roaming is enabled.
In the Roaming Information window or from **Advanced settings > WAN > 3G**, select **Allow 3G Roaming**.

Note: Roaming charges may apply.

- Check with Sprint – a network or account problem may be preventing your device from obtaining service.

Sprint Location Services Aren’t Working or Don’t Seem to Be Available

Ensure that GPS is enabled. See “Enabling GPS” on page 56.

For best results, minimize the number of obstructions between your device and the GPS satellites.

GPS Fix Not Available

Ensure you have a clear view of the sky; if you’re in a forested area, or in or near tall buildings, move to another location.

To retry a fix, click **Retry Now**. Otherwise, click **Cancel**.

Cannot Check for Updates

Ensure your device is connected to the AC charger or computer, through the USB to Micro B cable.

Note: If you’ll be using USB for data transfer (and not just for charging the device), you must install the device driver. See “Making a Tethered Connection” on page 27.

Sounds Are Enabled, but the Device Doesn’t Generate Any Sounds

Check that sounds are not turned off through the Mute switch on the device. See “Mute Switch” on page 17.

Section 7

*Technical Specifications,
Safety Information, and
Regulatory Information*



Section 7A

Technical Specifications

- ◆ LED Operation (page 132)
- ◆ Radio Frequency and Electrical Specifications (page 133)
- ◆ Software Specifications (page 134)
- ◆ Environmental Specifications (page 135)
- ◆ Mechanical Specifications (page 135)

LED Operation

See “Using the Power Button to Determine the Device State” on page 14.

Radio Frequency and Electrical Specifications

Approvals	FCC
Battery	<p>Size: 1800 mAh</p> <p>Duration for full charge:</p> <ul style="list-style-type: none"> ● AC charger: 1.5 hours ● PC USB cable: 3.6 hours <p>Charge life:</p> <ul style="list-style-type: none"> ● 4 hours under standard use ● 3 hours of continuous use
Current	<p>Maximum: 1000 mA</p> <p>Standby current:</p> <ul style="list-style-type: none"> ● 48 mA (1xEV-DO/IS2000 hybrid mode) ● 48 mA (WiMAX)
Transmit	<p>PCS: 1850 to 1910 MHz</p> <p>Cellular: 824 to 849 MHz</p> <p>WiMAX: 2495 to 2690 MHz</p>
Receive	<p>PCS: 1930 to 1990 MHz</p> <p>Cellular: 869 to 894 MHz</p> <p>WiMAX: 2495 to 2690 MHz</p> <p>GPS: 1575.42 MHz</p>

Software Specifications

CDMA (3G) specification	IS-2000 Release 0
Data service	IS-707A
WiMAX (4G) specification	IEEE 802.16e-2005
Wi-Fi specification	IEEE 802.11b IEEE 802.11g
Wi-Fi security and encryption protocols	WEP Open & Shared WEP-64 WEP-128 WPA-Personal TKIP & AES (Pre-Shared Key or WPA-PSK) WPA2-Personal TKIP & AES (WPA2-PSK) WPA+WPA2-Personal (WPA+WPA2 PSK)
SMS (IS-637)	Not supported
FAX	Not supported
IOTA	Supported
OTASP (IS-683A, IS-683B, IS-683C)	Supported
OTAPA	Supported
PRL (Preferred Roaming List)	Supported
Authentication	Supported
Voice	Not supported
NAM	Single
Position Location	Standalone
TTY/Accessibility	Not supported
Mobile IP	Supported
Network protocols (routing hardware)	TCP, UDP, ARP, RARP, ICMP
VPN	Pass-through of the following VPN types: <ul style="list-style-type: none"> ● PPTP ● IPSec Tunneling of multiple VPN sessions simultaneously is supported.

Environmental Specifications

Operating temperature	-4 to +131°F
Storage temperature	-40 to +185°F
Humidity	95%, non-condensing
Vibration	10–1000 Hz, 6G, 60 min/axis, 3 hrs total (non-operating)
Drop	1 m on concrete

Mechanical Specifications

Dimensions (W x L x H)	3.2" x 3.2" x 0.63"
Power button	Supported
Headset jack	Not supported
LED	White

Section 7B

Safety Information

- ◆ Important Notice (page 136)
- ◆ Safety and Hazards (page 136)

Important Notice

Due to the nature of wireless communications, transmission and reception of data can never be guaranteed. Data may be delayed, corrupted (i.e., have errors) or be totally lost. Although significant delays or losses of data are rare when wireless devices such as the Overdrive 3G/4G Mobile Hotspot are used in a normal manner with a well-constructed network, the device should not be used in situations where failure to transmit or receive data could result in damage of any kind to the user or any other party, including but not limited to personal injury, death, or loss of property. Sierra Wireless accepts no responsibility for damages of any kind resulting from delays or errors in data transmitted or received using the device, or for failure of the device to transmit or receive such data.

Safety and Hazards

Do not operate your device:

- In areas where blasting is in progress
- Where explosive atmospheres may be present
- Near medical equipment
- Near life support equipment, or any equipment that may be susceptible to any form of radio interference.

In such areas, your device **MUST BE POWERED OFF**. The Sierra Wireless modem can transmit signals that could interfere with this equipment.

Do not operate the device in any aircraft, whether the aircraft is on the ground or in flight. In aircraft, the device **MUST BE POWERED OFF**. When operating, the device can transmit signals that could interfere with various onboard systems.

Note: Some airlines may permit the use of cellular phones while the aircraft is on the ground and the door is open. The device may be used at this time.

The driver or operator of any vehicle should not operate the device while in control of a vehicle. Doing so will detract from the driver or operator's control and operation of that vehicle. In some jurisdictions, operating such communications devices while in control of a vehicle is an offence.

Proper Battery Use and Disposal

Note: Improper battery use may result in a fire, explosion, or other hazard.

To ensure safe and responsible battery use:

- Do not open, disassemble, puncture, crush, bend, or shred.
- Do not expose to water or other liquids, fire, explosion, or other hazards.
- Use the battery only in the Overdrive 3G/4G Mobile Hotspot.
- If using with a charger, use only the AC charger supplied with the device.
- Do not short circuit the battery.
- When replacing a battery, use the same model of battery that was supplied with the device.
- Follow local regulations when disposing of a used battery.
- Avoid dropping the device or the battery. If dropped and you suspect damage, take it to a service center for inspection.

Section 7C

Regulatory Notices

The design of the Overdrive 3G/4G Mobile Hotspot by Sierra Wireless complies with U.S. Federal Communications Commission (FCC) guidelines respecting safety levels of radio frequency (RF) exposure for mobile devices, which in turn are consistent with the following safety standards previously set by U.S. and international standards bodies:

- ANSI / IEEE C95.1-1999, *IEEE Standard for Safety Levels with Respect to Human Exposure to Radio Frequency Electromagnetic Fields, 3kHz to 300 GHz*
- National Council on Radiation Protection and Measurements (NCRP) Report 86, ?1986, *Biological Effects and Exposure Criteria for Radio Frequency Electromagnetic Fields*
- International Commission on Non-Ionising Radiation Protection (ICNIRP) 1998, *Guidelines for limiting exposure to time-varying electric, magnetic, and electromagnetic fields (up to 300 GHz)*

FCC ID: N7N-MHS801.

RF Exposure - This device is only authorized for use in a mobile application. At least 20 cm (8 inches) of separation distance between the Overdrive 3G/4G Mobile Hotspot by Sierra Wireless and the user's body must be maintained at all times.

WARNING (EMI) - United States FCC Information - This equipment has been tested and found to comply with the limits for a Class B computing device peripheral, pursuant to Parts 15 and 27 of the FCC rules. These limits are designed to provide reasonable protection against harmful interference in a residential installation.

This equipment generates, uses, and can radiate radio frequency energy and, if not installed and used in accordance with the instructions, may cause harmful interference to radio communications. However, there is no guarantee that interference will not occur in a particular installation.

If this equipment does cause harmful interference to radio or television reception, which can be determined by turning the equipment off and on, the user is encouraged to try to correct the interference by one or more of the following measures:

- Reorient or relocate the receiving antenna.
- Increase the separation between the equipment and receiver.
- Connect the equipment into an outlet on a circuit different from that to which the receiver is connected.
- Consult the dealer or an experienced radio/TV technician for help.

This device complies with Parts 15 and 27 of the FCC Rules. Operation is subject to the condition that this device does not cause harmful interference.

Section 7D

Legal

- ◆ Patents (page 139)
- ◆ Trademarks (page 139)
- ◆ Copyright (page 140)
- ◆ Limitation of Liability (page 140)
- ◆ Additional Information and Updates (page 140)

Patents

Portions of this product may be covered by some or all of the following US patents:

5,515,013	5,629,960	5,845,216	5,847,553	5,878,234	5,890,057
5,929,815	6,169,884	6,191,741	6,199,168	6,339,405	6,359,591
6,400,336	6,516,204	6,561,851	6,643,501	6,653,979	6,697,030
6,785,830	6,845,249	6,847,830	6,876,697	6,879,585	6,886,049
6,968,171	6,985,757	7,023,878	7,053,843	7,106,569	7,145,267
7,200,512	7,287,162	7,295,171	D442,170	D459,303	D559,256
D560,911					

and other patents pending.

This product includes technology licensed from QUALCOMM® 3G.

Manufactured or sold by Sierra Wireless Inc. or its Licensees under one or more patents licensed from InterDigital Group.

Trademarks

SPRINT and the logo are trademarks of Sprint.

“Heart of the Wireless Machine” is a registered trademark of Sierra Wireless. Sierra Wireless, the Sierra Wireless logo, TRU-Install, TRU-Locate, and the red wave design are trademarks of Sierra Wireless.

Windows® is a registered trademark of Microsoft Corporation.

Mac and Mac OS are trademarks of Apple Inc., registered in the U.S. and other countries.

Linux® is the registered trademark of Linus Torvalds in the U.S. and other countries.

Wi-Fi, WPA, and WPA2 are registered marks of the Wi-Fi Alliance.

QUALCOMM® is a registered trademark of QUALCOMM Incorporated.

Other trademarks are the property of the respective owners.

Copyright

©2010 Sprint. All rights reserved. No reproduction in whole or in part without prior written approval.

Limitation of Liability

The information in this manual is subject to change without notice and does not represent a commitment on the part of Sierra Wireless. SIERRA WIRELESS AND ITS AFFILIATES SPECIFICALLY DISCLAIM LIABILITY FOR ANY AND ALL DIRECT, INDIRECT, SPECIAL, GENERAL, INCIDENTAL, CONSEQUENTIAL, PUNITIVE OR EXEMPLARY DAMAGES INCLUDING, BUT NOT LIMITED TO, LOSS OF PROFITS OR REVENUE OR ANTICIPATED PROFITS OR REVENUE ARISING OUT OF THE USE OR INABILITY TO USE ANY SIERRA WIRELESS PRODUCT, EVEN IF SIERRA WIRELESS AND/OR ITS AFFILIATES HAS BEEN ADVISED OF THE POSSIBILITY OF SUCH DAMAGES OR THEY ARE FORESEEABLE OR FOR CLAIMS BY ANY THIRD PARTY.

Notwithstanding the foregoing, in no event shall Sierra Wireless and/or its affiliates aggregate liability arising under or in connection with the Sierra Wireless product, regardless of the number of events, occurrences, or claims giving rise to liability, be in excess of the price paid by the purchaser for the Sierra Wireless product.

Additional Information and Updates

For up-to-date product descriptions, documentation, application notes, firmware upgrades, troubleshooting tips, and press releases, visit www.sierrawireless.com.

Numerics

3G

- Overview4
- 3G panel of the WAN tab91
- 3G Roaming Information window43
- Activation failed 125
- Activation information, viewing91
- Activation, initiate34
- Configuration, resetting to default settings92
- Data transmission rates4
- Improving network service, tips 120
- Lifetime data78
- Mobile Broadband Information window .42
- PRL version 62, 77, 92
- Service type91
- 3G (time acquisition method) 111
- 3G Activation Required 126
- 3G Activation Required (alert)34
- 3G Network Update Available (alert)35
- 3G Only 42, 78
- 3G panel of the WAN tab91
- 3G Preferred 42, 78
- 3G Roaming Information window43
- 3G/4G Off 42, 78

4G

- Overview4
- 4G panel of the WAN tab79
- Base Station ID (BSID)79
- Configuration, resetting to default settings92
- Connection status79
- Data transmission rates4
- Lifetime data78
- Mobile Broadband Information window .42
- Network access provider (NAP-ID)79
- Network service provider (NSP-ID)79
- Roaming support 117
- Service type79
- 4G Only 42, 78
- 4G Preferred 42, 78
- 802.11 standards supported 134

A

- About panel of the Device tab76
- About this guide5
- AC charger with USB port12

- AC power settings 68
- AC powered 46
- Access to the network, configuring 87, 88
- Accessories 114
- Account information62, 77, 114
- Account, setting up your device on 20
- Accuracy, GPS 95
- Acquisition, time, method used for 111
- Activate now 24
- Activating network service 24
- Activation complete! 34
- Activation Required (alert) 34
- Activation, 3G
 - 3G Activation Required 126
 - 3G Activation Required alert 34
 - Date of original activation 91
 - Failed 125
- Active network 41, 78
- Admin Login area of the home page 31
- Admin Setup button 49
- Administrator + Guest 52
- Administrator password
 - Changing 73
 - Forgotten; what do I do? 117
- Advanced Settings window 49, 74
- AES 23, 85
- Alert
 - 3G Activation Required 34
 - Alert window 43
 - Audio, enabling and disabling 71
 - Critical battery level alert 72
 - Displaying 34
 - GPS Privacy Agreement 35
 - Low battery 72
 - Network Update Available 35
 - SD Card Error 36
 - Software Update Available 36
 - Sounds panel of the Device tab 76
- Alert when (low battery) 72
- Alert window 43
- Allow 3G roaming 43, 92
- Allow all in list (giving computers access to the network) 87
- Allow international access 43
- Allowing computers access to the network 87
- Always on, and billing 117

Apple Safari	6
Application notes	140
Application updates	58
ATM machines, search for	57
Automatically check for updates	58
Automatically log in	
Viewing list of computers set to automatically log in	73
B	
Baby monitors	120
Backlight (LCD on the device)	
Brightness	69
Turning off automatically	69
Turning on or off	69
Banks, search for	57
Base Station ID (BSID)	79
Basic panel of the Device tab	74
Basic panel of the Router tab	96
Battery	
Overview	9
Battery Information and Settings window	46
"Better battery life" setting	46, 68, 81
Charging	11
Critical battery level alert	71, 72
Extending battery life	119
Icon	46
Low battery alert	72
Low battery, play sound	48
Proper use and disposal	137
Specifications	133
Battery Information and Settings window	46
Battery or USB powered	46, 68
Better battery life	46, 68, 81
Billing and "always on"	117
Billing cycle, data statistics	47
Blacklist	82, 87
Block (block a computer's access to the Wi-Fi network of the device)	45
Block all in list	87, 88
Box contents	4
Brightness of LCD	69
Broadcast the SSID (Wi-Fi network name)	81
Browser interface	
Updates	58
See also Home page.	
Browsers supported	6

BSID (Base Station ID)	79
Buttons	
Below the virtual device	51
Top of home page	49
C	
Cannot connect to the 3G/4G network	129
Cannot connect to Wi-Fi	127
Cannot display the home page	127
Care of your device	5
Carrier to Interference-plus-Noise Ratio (CINR)	42
CDMA	
See 3G.	
Cell phones	120
Center frequency	79
Charging the device	11
Check for updates	
Automatically	58
Manually	59
Check for updates now	59
Chrome browser	6
CINR (Carrier to Interference-plus-Noise Ratio)	42
Clear Log (connection history)	109
Clear Log (system events)	110
Coffee shops, search for	57
Components of your device	3
Connect button	51
Connect to Internet	
Alert	71, 76
Cannot connect	129
Improving 3G network service, tips	120
Launching a connection	38
Sharing your connection	38
Connected	
How to tell you're connected to 3G/4G	116
Icon	42
Play sound when connected or disconnected	48
Wi-Fi users information	45
Connected computers, displaying a list of	88
Connected Users window	45
Connecting the device to your computer	
USB	27
Wi-Fi	116
Connecting to 3G/4G message	125

Connection	
Ending	39
History log	109
Improving 3G network service, tips	120
Information, displaying	47
Launching	38
Lost (alert)	71, 76
Settings	42, 78
Sharing	38
Status, 3G	41, 91
Status, 4G	41, 79
Wi-Fi users information	45
Connection Error message	126
Connection history	
Clearing	109
Description	109
Enabling logging	109
Exporting	109
Contents, package	4
Contextual Help	115
Continuous fix	44, 80, 93
Cordless phones	120
Corporate network, accessing through	
VPN	118
Could not connect to remote server	127
Coverage maps	114
Coverage type(s) available	41, 91
Critical battery level alert	72
Critical temperature alert	71
Current location, opening in a Web	
browser	57
Current, electrical (specification)	133
Customer Service, contacting	114
D	
Dark LCD	124
Data Link, Sprint	118
Data statistics for the current connection	
session	47
Data transferred	47, 78
Data transmission rates	4
Default settings	
3G/4G configuration, resetting	92
Software, resetting	105
Denying computers access to your	
network	88
Destination IP Address	105
Device	
Overview	2
Account, setting up on	20
Components	3
Information, viewing	62, 76
Name (host name)	84
Device driver, installing	27
Device name (host name)	89
Device tab	
About panel	76
Basic panel	74
Display panel	75
Log panel	77
microSD card panel	75
Sounds panel	76
DHCP	
Clients, maximum number of	99
Description	98
Enabling	99
Lease time	99
Start and end address	99
Static IP Assignment List	99
DHCP IP Address Range	99
Disable Wi-Fi upon USB-PC	90
Disable Wi-Fi when connected via USB	90
Disconnect button	51
Display panel of the Device tab	75
Displaying	
Home page	31
Location information	56
Disposal of battery	137
DMZ	
Configuring	105
DMZ panel of the Router tab	104
Enabling	104
DMZ panel of the Router tab	104
DNS Mode	101
DNS Relay	98
Document overview	5
Dormant	91
Download speeds	4
Drawing of hardware	13
Driver, installing	27
Drop specification	135
Duration for full charge	133
Duration, session	47, 78
E	
Ec/lo	41, 91

Electrical specifications	133	Google Chrome	6
Electronic Serial Number (ESN)	62, 77	Google Maps	44, 80
Email server, accessing	101	GPS	56
Enable GPS	56	Overview	118
Enable SD Card	52	Accuracy	95
Enhanced Local Search	118	Availability	118
Environmental specifications	135	Enabling	56
ESN (Electronic Serial Number)	62, 77	Enhanced Local Search	118
Exporting		GPS Fix Not Available	129
Connection history	109	GPS Information and Settings window	44
Settings	108	GPS panel of the WAN tab	80
System event log	110	Limitations	118
F		Location information, displaying	56
Failover wait time	79	Location, current, opening in a Web	
Failure, device startup		browser	57
Audio alert	71	Mapping service	94
FAQ (Frequently Asked Questions)	116	Mode ("GPS mode")	44, 80, 93
FCC (regulatory) notices	138	Not working or doesn't seem to be	
FCC ID	138	available	129
Feedback	50	Performance	94
Firefox browser	6	Requirements	56
Firewall software	128	GPS Fix in Progress	57
Firmware version		GPS Fix Not Available	129
3G modem	77	GPS panel of the WAN tab	80
4G modem	77	GPS Privacy Agreement (Alert)	35
Routing hardware	62, 77	Guest Password (for microSD card	
Firmware, upgrade from a file	60	access)	53
Fix rate	94	Guest Username (for microSD card	
Fix, GPS		access)	53
Fix rate	94	H	
Get fix now	44, 80	Hardware	13
GPS Fix Not Available	129	Hazards	136
Type of fix ("GPS mode")	44, 80	Help button	50
Folder name, microSD card	53	Help files, updates	58
Forgot administrator password	117	Help for Advanced Settings	115
Forgot Wi-Fi password	117	Help, getting	
Forward Ports	103	Customer Service, contacting	114
Frequencies, transmit and receive	133	FAQ (Frequently Asked Questions)	116
Frequently Asked Questions (FAQ)	116	Online Help	114
FTP server, accessing	101	Sprint website	114
Full charge	133	Tips	119
G		Troubleshooting	124
Gaming, Internet	103	HEPE (Horizontal Estimated Position	
Gas stations, search for	57	Error)	44
Get fix now	44, 57, 80	Home page	
Get Started guide	4	Buttons along the top	49
		Cannot display	127

Description	29
Displaying	31
icons and text	40
Logging in	31
Virtual device	32
Horizontal Estimated Position Error (HEPE)	44
Host name	84, 89
Hotels, search for	57
Humidity specification	135

I

Icons	
Home page	40
LCD	16
Important information booklet	50
Important notice	136
Importing settings	108
Improving signal strength	120
IMSI (International Mobile Station Identity)	62, 77, 91
Information about your device	62, 76
Installing the device	20
International access, allow	43
International Mobile Station Identity (IMSI)	62, 77, 91
Internet Connected	71
Internet Connection Information window	47
Internet Disconnected	71
Internet Explorer	6
Internet Explorer cannot display the webpage	127
Internet gaming	103, 104
Internet telephony	103
IOTA	134
IP address	
Assigning based on a MAC address	100
Finding for a device	123
Routing hardware	97
WWAN, of the device	47

K

Knowledge base	124
----------------	-----

L

LAN panel of the Router tab	97
Last user has left (audio alert)	71, 76
LBS (Location Based Services)	

See GPS.

LCD	
Brightness	69
Dark	124
Icons on LCD	16
Not lit	124
Timeout	69
Turning off automatically	69
Turning on or off	69
Lease time, DHCP	99
LED (Power button on the device)	
Description	15
Interpreting	14
Location	13
Liability, limitation of	140
Lifetime data	78
Lifetime of product	
Total data transferred	78
Limitation of liability	140
Limitations, GPS	118
Link SSID and Host Name	84
List of connected computers, displaying	88
List of connected devices	88
Location search	57
Location Services	
See GPS.	
Location, current, opening in a Web browser	57
Log	
Connection history	109
System events	110
Log panel of the Device tab	77
Logging in	
Automatically	73
Steps to log in	31
Login password	
Changing	73
Forgotten; what do I do?	117
Longer Wi-Fi range	46, 68, 81
Low battery alert	72
Low power mode (Standby Timer)	46

M

MAC (Media Access Control) filter	82, 87
MAC address	
4G modem	62, 77
Finding for a device	122
IP address, assigning	100

Wi-Fi users	45
MAC filter mode	82, 87
MAC Filter panel of the Wi-Fi tab	82
Maintenance of your device	5
Manual Activation	79
Manufacturer information	62, 77
Map me button	50, 57
Mapping service	94
MapQuest	44, 80
Max number of Wi-Fi users	89
Maximum number of Wi-Fi users	89
Mechanical specifications	135
MEID (Mobile Equipment Identifier)	62, 77
Metric units, use for GPS	94
microSD card	
Overview	17
Accessing	52, 54
Enabling	52
Inserting	53
Location of slot	13, 17
microSD Card panel of the Device	
tab	75
Removing	54
SD Card Error (alert)	36
SD Card Information and Settings	
window	47
Shared folder name	53
microSD Shared Folder Name	53
Microwaves	120
Mini Window	32
Mobile Broadband Information window	42
Mobile Equipment Identifier (MEID)	62, 77
Mobile Station ID (MSID)	62, 77, 91
Model information	62, 77
Mozilla Firefox	6
MSID (Mobile Station ID)	62, 77, 91
Mute switch, location	17

N

NAI (Network Access Identifier)	91
NAP-ID (Network Access Provider ID)	79
Network	
3G, overview	4
4G Base Station ID (BSID)	79
4G network access provider (NAP-ID)	79
4G service provider (NSP-ID)	79
4G, overview	4
Active network	41, 78

Cannot connect	129
Network operator	78
Protocols supported	134
See also Wi-Fi.	
Network Access Identifier (NAI)	91
Network access provider, 4G (NAP-ID)	79
Network access, configuring	87
Network operator	
3G	91
4G (NSP-ID)	79
Network panel of the Wi-Fi tab	81
Network service	
3G, tips on improving service	120
Activating	24
Network Time Protocol (NTP)	111
Network Update Available (alert)	35
Network, corporate, accessing	
through VPN	118
No filtering	87
No service	
Icon	42
Not connected	42
Notice, important	136
Notices, regulatory	138
NSP-ID (Network Service Provider ID)	79
NTP (Network Time Protocol)	111

O

Obtain an IP address automatically	98
One-time fix	44, 80, 93
Online games	101, 103
Online Help	
Contextual Help	115
Displaying	114
Updates, getting	58
Oops! This link appears to be broken	127
Opera browser	6
Operating temperature	135
Operator, network	
3G	91
4G (NSP-ID)	79
Original activation date	91
OTAPA	134
OTASP	134
Overview of this document	5

P

Package contents	4
------------------	---

Password reminder, Wi-Fi	86
Password, administrator	
Changing	73
Forgotten; what do I do?	117
Password, Wi-Fi	
Changing	86
Forgotten; what do I do?	117
Reminder	86
Patents	139
Pay-as-you-go	92
Performance (GPS setting)	94
Performance Value	80
Performance, Wi-Fi, tips on improving	121
Place for your device, tips	120
Plug and Play, Universal (UPnP)	97
Port Forward panel of the Router tab	101
Port forwarding	
Description	101
Disabling for an application	102
Enabling	102
Enabling for an application	102
Port Trigger panel of the Router tab	103
Port triggering	
Description	103
Enabling	103
Ports, adding	103
Ports, removing	104
Power button (on the device)	
Description	15
Interpreting	14
Location	13
Power Off button	33, 51
Power settings	
AC	68
Battery powered	68
Extending battery life	119
USB powered	68
Powering the device off	14, 33
Powering the device on	13
PRI version	
Routing hardware	62, 77
PRL update	
Alert (update available)	35
Checking if available	79
Loading a file	92
PRL version	
3G modem	62, 77, 92
Problems	

See Troubleshooting.

Protocols, network, supported	134
-------------------------------	-----

Q

Questions, frequently asked (FAQ)	116
-----------------------------------	-----

R

Radio frequency (RF) specifications	133
Receive frequencies	133
Recharging the battery	11
Regulatory notices	50, 138
Remember me	73
Remember me client list	73
Remember me computers, view list of	73
Reminder, Wi-Fi password	86
Remote Desktop, accessing	101
Requirements	
GPS	56
Installation	6
USB	26
Reset button on device	64
Reset Device to Factory Defaults button	92
Resetting the 3G/4G configuration to	
default settings	92
Resetting the software to default settings	105
Restarting the device	65
Restaurants, search for	57
Restriction field	105
RF (Radio Frequency) specifications	133
Roaming	
3G Roaming Information window	43
4G support	117
Enabling and disabling	92
International access, allow	43
Roaming status	92
Router tab	
DMZ panel	104
LAN panel	97
Port Forward panel	101
Port Trigger panel	103
Routing hardware	
Firmware version	62, 77
IP address	97
Play sound when routing hardware	
reset	71
PRI version	62, 77
Resetting to default settings	105
Subnet mask	97

Routing hardware settings reset	
Audio alert	48, 71
Performing	105
RSSI (signal strength)	
Improving	120
Insufficient	125
Viewing	41
Rx (receive) frequencies	133

S

Safari browser	6
Safari can't open the page	127
Safety and hazards	136
SD Card error (alert)	36
SD Card Information and Settings window	47
Search, location	57
Searching for Network	126
Security	
Network access, configuring	87
SPI (Stateful Packet Inspection)	97
Tips	122
Wi-Fi	85
Security panel of the Wi-Fi tab	82
Server, accessing	101
Service icon	42
Service plan, add additional options	114
Service Programming Code (SPC)	92
Service type	
3G	91
4G	79
Session duration	47, 78
Session total data	78
Set Guest Password (for microSD card access)	53
Set Guest Username (for microSD card access)	53
Set up my device	21
Setting up the device	20
Settings	
Exporting	108
Importing	108
Setup panel of the WAN tab	78
Shared folder name, microSD card	53
Sharing your Internet connection	38
Short text messaging (SMS)	134
SID (System ID)	91
Sierra Wireless knowledge base	124
Signal Quality window	41

Signal strength	
Improving	120
Insufficient	125
Viewing	41
Size of device	135
SMS	134
Software	
Resetting to default settings	105
Specifications	134
Updates	58
Version information	62, 77
Software Update Available (alert)	36
Sounds	
Enabling and disabling individually	71
Enabling or disabling all (Mute switch)	17
Sounds panel of the Device tab	76
Sounds window	48
Source IP Address	105
SPC (Service Programming Code)	92
Specifications	
Electrical	133
Environmental	135
Mechanical	135
Radio frequency (RF)	133
Software	134
Speeds, download	4
SPI (Stateful Packet Inspection)	97
Sprint Data Link	118
Sprint Location Services	
See GPS.	
Sprint stores, search for	57
Sprint website	114
ssh support	118
SSID (Wi-Fi network name)	
Broadcast	81
Changing	83
Description	83
Host Name, link to	84
Standby Timer	46
Start day of the billing cycle, changing	47
Starts on day	47
Startup failure, device (audio alert)	71
Stateful Packet Inspection (SPI)	97
Static IP Assignment List, DHCP	99
Storage guidelines	5
Storage temperature	135
Stores, Sprint, search for	57
Subnet mask	97

Support button	50
Support, contacting	114
Switchback wait time	79
System alerts	71, 76
System events log	
Clearing	110
Enabling	110
Exporting	110
Types of events included	110
System ID (SID)	91
System requirements	6
T	
TCP/IP settings	98
Technical support, contacting	114
telnet support	118
Temperature specifications	135
Temperature, critical (audio alert)	71
Terminal sessions	118
Tethered connection	
See USB.	
Text messaging (SMS)	134
The connection has timed out	127
Time acquisition method	111
Timeout	
Connection timeout (cannot display	
the home page)	127
LCD	69
Timestamp (GPS)	44
Tips	119
TKIP/AES	23, 85
Total data	78
Trademarks	139
Transmission rates	4
Transmit frequencies	133
Transmitter power	79
Trigger Ports	103
Troubleshooting	
Cannot connect to the 3G/4G	
network	129
Cannot connect to Wi-Fi	127
Cannot display the home page	127
General tips	124
TRU-Install	26
TTY	134
Turn Backlight Off	69
Turning the device off	14, 33
Turning the device on	13

TVs	120
Tx (transmit) frequencies	133
Tx Power	79

U

Universal Plug and Play (UPnP)	97
Update 3G PRL	79
Update 3G profile	79
Update Failed	126
Update firmware from file	60
Updates	
Overview	58
3G Network Update Available (alert)	35
Automatically check	58
Cannot check for	129
Firmware, upgrade from a file	60
Manually check	59
PRL	35, 79
Software Update Available (alert)	36
UPnP (Universal Plug and Play)	97
Usage guidelines for your device	5
USB	
Charging the device	11, 12
Connecting the device to your	
computer through USB	27
Location of USB slot on the device	13
Power settings	46
Requirements	26
Wi-Fi, disabling when connected	
through USB	90
User ID, 3G network	91

V

Vertical row of icons and text	40
Vibration specification	135
Video conferencing	103, 104
View privacy agreement	44
Virtual device	32
Voice over Internet Protocol (VoIP)	103
VoIP (Voice over Internet Protocol)	103
VPN	
Accessing	118
Passthrough types supported	134

W

Wait time	
Failover	79
Switchback	79

WAN mode	78
WAN tab	
3G panel	91
4G panel	79
GPS panel	80
Setup panel	78
Warning (EMI)	138
Warning (software settings reset)	105
Warranty	50
Web browsers supported	6
Web server, accessing	101
Website	
Sierra Wireless	140
Sprint	114
Welcome to Your Device window - Select an Option	112
WEP	23, 85
Whitelist	82, 87
Wi-Fi	
Alerts (user has joined, or left)	71, 76
Cannot connect	127
Channel	90
Configuring, overview	83
Connected computers, displaying list of	88
Connecting to	116
Longer Wi-Fi range	46, 68, 81
MAC Filter panel of the Wi-Fi tab	82
Maximum number of users	89
Network panel of the Wi-Fi tab	81
Password	86
Password Reminder	86
Password, forgot	117
Performance, tips on improving	121
Security	85
Security and encryption protocols supported	134
Security panel of the Wi-Fi tab	82
Sounds when user joins or leaves	48
SSID (Wi-Fi network name)	83
USB tethered mode	90
Wi-Fi users information	45
Windows XP	
improving Wi-Fi performance	121
Wireless speakers	120
WPA	23, 85
WPA2	23, 85
WWAN IP address of the device	47

X

XP

improving Wi-Fi performance	121
-----------------------------------	-----

Y

Your device is now restarting (window) ...	24
--	----

Free Manuals Download Website

<http://myh66.com>

<http://usermanuals.us>

<http://www.somanuals.com>

<http://www.4manuals.cc>

<http://www.manual-lib.com>

<http://www.404manual.com>

<http://www.luxmanual.com>

<http://aubethermostatmanual.com>

Golf course search by state

<http://golfingnear.com>

Email search by domain

<http://emailbydomain.com>

Auto manuals search

<http://auto.somanuals.com>

TV manuals search

<http://tv.somanuals.com>