



Speed Queen

Use and Care Guide Home Laundry Automatic Washer



D249IE3A

**Models:
AWM472W2
AWM473W2**

KEEP THESE INSTRUCTIONS FOR FUTURE REFERENCE. (If the washer changes ownership, be sure this manual accompanies the washer.)

**Part No. 36729R2
10/96**

Congratulations on your purchase of a new Automatic Washer. Your washer has been carefully constructed for years of dependable service, using many of the same rugged, reliable components which are in many coin-operated machines.

Table of Contents

Important Safety Instructions	3
Before Washing	
Prepare Wash Load	5
Sort	5
Pretreat	5
Loading the Washer	
Load Articles	6
Load Sizes	6
Water Level	6
Water	
Water Hardness	7
Iron	7
Wash Temperature	7
Laundry Tips	8
Washing Temperature Guide	9
Bleach Dispenser	9
Agitator Cap	9
Fabric Softener Dispenser and Agitator	9
How To Use Your Washer	
Determine Proper Cycle	11
To Wash Clothes	11
Soaking	12
Timer	12
Special Care	
Starching	13
Knits	13
Permanent Press	14
Washing Special Items	15
Washing Problems	16
Stain Removal	17
Maintenance	
Cold Weather Care	20
Care Of Your Washer	20
Vacations and Extended Non-Use	20
Operating Tips	
Out-Of-Balance Switch	20
Motor Overload Protector	20
Before You Call For Service	21
If Service Is Required	21
Information For Handy Reference	Inside Back Cover

▲ WARNING

**FOR YOUR SAFETY
and to reduce the risk of fire or an
explosion, do not store or use
gasoline or other flammable vapors
and liquids in the vicinity of this or
any other appliance.**

IMPORTANT SAFETY INSTRUCTIONS

(Save These Instructions)

▲ WARNING

To reduce the risk of fire, electric shock, serious injury or death to persons when using your washer, follow these basic precautions:

1. Read all instructions before using the washer.
2. Refer to the GROUNDING INSTRUCTIONS in the INSTALLATION manual for the proper grounding of the washer.
3. Do not wash articles that have been previously cleaned in, washed in, soaked in, or spotted with gasoline, dry-cleaning solvents, other flammable or explosive substances as they give off vapors that could ignite or explode.
4. Do not allow children to play on or in the washer. Close supervision of children is necessary when the washer is used near children. This is a safety rule for all appliances.
5. Before the washer is removed from service or discarded, remove the lid to the washing compartment.
6. Do not reach into the washer if the washtub is revolving.
7. Do not install or store the washer where it will be exposed to water and/or weather.
8. Do not tamper with the controls.
9. Do not repair or replace any part of the washer, or attempt any servicing unless specifically recommended in the user-maintenance instructions or in published user-repair instructions that you understand and have the skills to carry out.
10. Do not add gasoline, dry-cleaning solvents, or other flammable or explosive substances to the wash water. These substances give off vapors that could ignite or explode.
11. Under certain conditions, hydrogen gas may be produced in a hot water system that has not been used for two weeks or more. **HYDROGEN GAS IS EXPLOSIVE.** If the hot water system has not been used for such a period, before using a washing machine or combination washer-dryer, turn on all hot water faucets and let the water flow from each for several minutes. This will release any accumulated hydrogen gas. **THE GAS IS FLAMMABLE, DO NOT SMOKE OR USE AN OPEN FLAME DURING THIS TIME.**
12. To reduce the risk of an electric shock or fire, **DO NOT** use an extension cord or an adapter to connect the washer to the electrical power source.
13. Use your washer only for its intended purpose, washing clothes.
14. **ALWAYS** disconnect the washer from electrical supply before attempting any service. Disconnect the power cord by grasping the plug, not the cord.
15. Install the washer according to the INSTALLATION INSTRUCTIONS. All connections for water, drain, electrical power and grounding must comply with local codes and be made by licensed personnel when required. Do not do it yourself unless you know how!
16. To reduce the risk of fire, clothes which have traces of any flammable substances such as vegetable oil, cooking oil, machine oil, flammable chemicals, thinner, etc. must not be put into the washer. These flammable substances may cause the fabric to catch on fire by itself.
17. Do not use fabric softeners or products to eliminate static unless recommended by the manufacturer of the fabric softener or product.
18. Keep your washer in good condition. Bumping or dropping the washer can damage safety features. If this occurs, have your washer checked by a qualified serviceman.
19. Replace worn power cords and/or loose plugs.
20. Be sure water connections have a shut-off valve and that fill hose connections are tight. **CLOSE** the shut-off valves at the end of each wash day.

(continued)

21. Loading door **MUST BE CLOSED** any time the washer is to agitate or spin. **DO NOT** by-pass the loading door switch by permitting the washer to agitate or spin with the loading door open. A brake will stop the washtub within seconds if the loading door is opened during spinning. If the washtub does not stop when the loading door is opened, remove the washer from use and call the serviceman.
22. Always read and follow manufacturer's instructions on packages of laundry and cleaning aids. Heed all warnings or precautions. To reduce the risk of poisoning or chemical burns, keep them out of the reach of children at all times (preferably in a locked cabinet).
23. Always follow the fabric care instructions supplied by the garment manufacturer.
24. Never operate the washer with any guards and/or panels removed.
25. **DO NOT** operate the washer with missing or broken parts.
26. **DO NOT** by-pass any safety devices.
27. Failure to install, maintain, and/or operate this machine according to the manufacturer's instructions may result in conditions which can produce bodily injury and/or property damage.

NOTE: The WARNING AND IMPORTANT SAFETY INSTRUCTIONS appearing in this manual are not meant to cover all possible conditions and situations that may occur. It must be understood that common sense, caution and carefulness are factors which **CANNOT** be built into the washer. These factors **MUST BE** supplied by the person(s) installing, maintaining, or operating the washer.

Always contact your dealer, distributor, service agent or the manufacturer about any problems or conditions you do not understand.

Before Washing . . .

Prepare Wash Load

Empty Pockets and Cuffs

Make sure all pockets are empty and turn them inside out. One bobby pin, metal or plastic toy, nail or sharp object in a load can catch laundry and cause tears. Facial tissue left in a pocket will produce extreme "lint". A crayon or lipstick in a wash load may cause stains that cannot be removed. Roll down cuffs and shake out grass, sand, and gravel.

Mend Rips and Tears

Little holes can become bigger in the washer. Mend holes and tears before placing garments in the washer.

Close Zipper and Fasten Hooks

These can catch on garments in a wash load and tear them. Tie belts and sashes so they won't wind around clothes.

Remove Nonwashable Trim

Check for colorfastness too, by squeezing a portion of garment in warm or hot sudsy water. If the color bleeds or runs, wash the item separately in cold water.

Sort

Proper sorting is easy if you follow a few guidelines:

1. Sort by Color

Whites

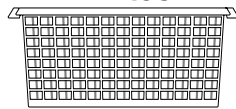

Lights

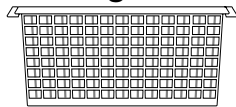

Darks

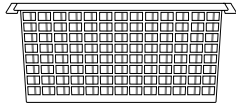

Non-Colorfast

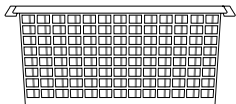

W3081E0A

2. Sort by Fabric and Construction

Cottons and Linens

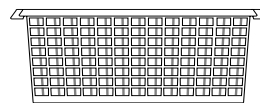

Synthetics, Blends & Poly Knits

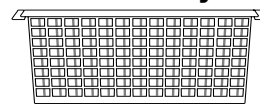

Permanent Press

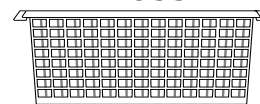

Delicates

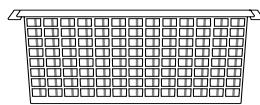

W3091E0A

3. Sort by Care Label

Cold

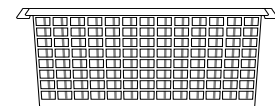

Warm

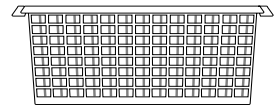

Hot

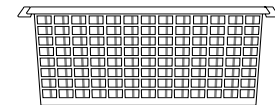

W3101E0A

4. Sort By Type and Amount of Soil

Children's play clothes, as well as work clothes, will need extra treatment. Lightly soiled clothes can become dingy if washed with heavily soiled items.

5. Sort Lint "Shedders" From Lint "Receivers"

Some fabrics attract lint and should not be washed with lint-shedding loads. Lint shedders are cottons, terry towels, chenille bedspreads, rugs, and clothes which have been heavily bleached.

Lint receivers are synthetics, permanent or durable press, knits (including socks), corduroy, and other smooth fabrics.

Pretreat

Pretreat shirt collars and cuffs with a pre-wash product or liquid detergent when placing them in the washer. Before washing, treat special stains with bar soap, liquid detergent or a paste of water and granular detergent. Use a pretreat soil and stain remover.

Loading the Washer . . .

Load Articles

Load items by the amount of space they take up, not by their weight. Mix large and small items in a load to get the best washing results.

Drop items loosely into the washtub. The bulk of the clothes rather than the weight will determine load size. Do not pack items in or wrap them around the agitator. Overloading can cause poor cleaning, excessive wrinkling, and tears.

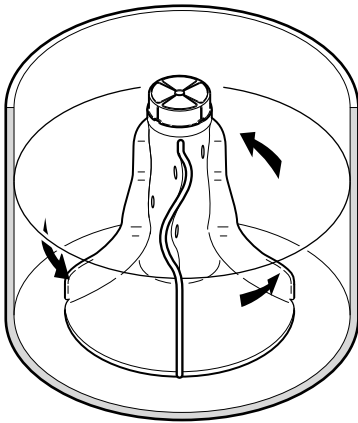

W2871E0A

Items should move freely through the wash water for best cleaning results. Items should rollover — sink and then reappear.

When washing very large items, do not fill washtub as full as with other loads.

Load Sizes

Small

- 3-4 perm. press dress shirts
- OR
- 1 twin sheet, 1 pillow case
- OR
- 1-2 lightweight dresses

Medium

- 6-7 perm. press shirts
- OR
- 2 twin sheets, 2 pillow cases
- OR
- 8 bath towels, 6 bath cloths

Large

- 10-11 perm. press shirts
- OR
- 2 full size sheets, 2 pillow cases, 2 pair men's pajamas
- OR
- 12 bath towels, 4 hand towels, 4 wash cloths

Extra Large

- 8-9 shirts and
- 5 pair polyester pants
- OR
- 2 queen size sheets,
- 4 pillow cases, 2 nightgowns
- 1 pair men's pajamas
- OR
- 1 queen size bedspread

Reset

Use the RESET if agitation has started and more water is needed for the load.

Water Level

Right

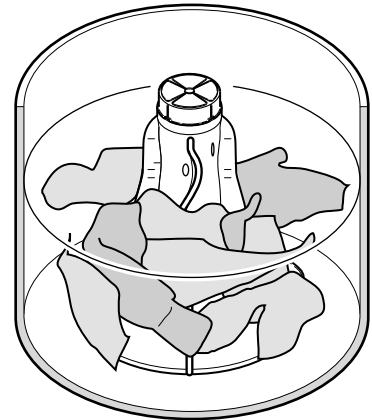

W2781E0A

Wrong

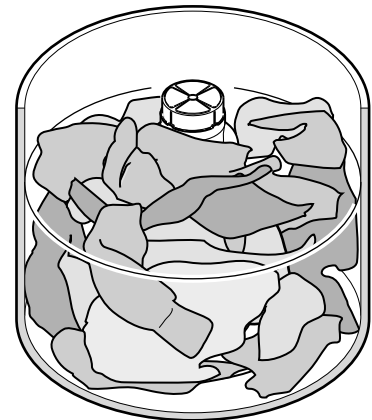

W2791E0A

(Illustrations shown with agitator cap. Your washer may have a fabric softener dispenser on agitator).

The water level in your washer should fit the size of your wash load. Small loads will use lower water levels. There must be enough water in the washtub to allow items to move and turn over freely.

Overloading the washtub can result in poor washing and rinsing. Overloading may also cause wrinkling and tearing of items.

Water . . .

Water Hardness

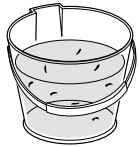

Soft Water
0 to 3.5 grains
per gallon

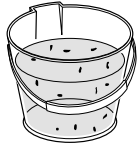

**Moderately Hard
Water**
3.6 to 7 grains
per gallon

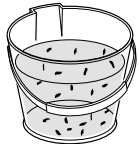

Hard Water
7.1 to 10.5 grains
per gallon



Very Hard Water
More than 10.6
grains per gallon

W120IE0A

Water hardness is measured in grains per gallon (G.P.G.) or parts per million (P.P.M.). To learn your water hardness, call your Water Department or State Extension Service. Hard water will not remove soil as well as soft water and can result in gray, dingy laundry. To get clothes clean in hard water, use more detergent. Do not use soap.

Hard Water May Be Softened By:

1. A mechanical water softener installed in your home.
2. The use of a packaged non-precipitating water conditioner.

Soft Water

Water should be soft enough to allow soaps and detergents to remove soil effectively. Clothes will be whiter and brighter when

Iron

If iron is present in the water, the clothes may become an all-over yellow or they may be stained with brown or orange spots or streaks. Iron is not always visible in the water.

Solutions to Iron Problems

The installation of a water softener will remove small amounts of iron from the water supply. The installation of an iron filter may be necessary for more severe cases. If the iron comes from the pipes, it may be sufficient just to let the water run into the empty washer for about one minute. This may help to clear the pipes. Spin this water out of the washtub before starting the wash.

If iron comes from the water heater, drain the heater occasionally to remove the rust.

If the Iron Condition Cannot Be Corrected

Prepare the wash water first by adding detergent (not soap), then add the clothes to the washtub. Use a phosphate detergent. The phosphate content of a detergent is listed on the package side panel.

Add a nonprecipitating water conditioner to the washtub just before the rinse water enters. Do not use fabric softener in the rinse water if a packaged water conditioner is used.

Iron With Chlorine Bleach

The use of chlorine bleach with water that contains iron will make the rust discoloration worse. Use an "all fabric" bleach.

Wash Temperature

Hot Water

Hot water will give the best results of cleaning and sanitizing, but it is not suitable for all items. It is best for sturdy whites and colorfast items, heavily soiled items and diapers.

Warm Water

By using warm water, there is less chance of color loss in items. Warm water also reduces wrinkling in permanent press items. Use with light and moderate soils, non-colorfast or dark colors, permanent press, silks, woolens, nylon, and acrylic.

Cold Water

Cold water is less effective in cleaning than hot or warm water, but it does minimize wrinkling and color fading. Use it for washing extra-sensitive clothes and for the rinsing of all fabrics.

Energy

You can save energy when washing by following a few guidelines:

1. Heating water accounts for the greatest energy expense when washing. Save on heating water by using cold rinses.
2. Wash full loads, but do not overload.
3. Use soak cycles for heavily soiled items to reduce wash times.
4. Select a shorter wash time for lightly soiled items.

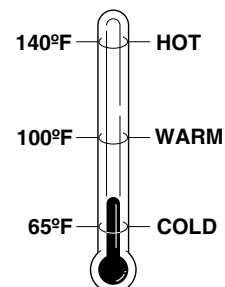

W121IE0A

Laundry Tips . . .

Laundry Aids	Use	Comments
Soak/Pretreat Products	<ul style="list-style-type: none"> • Use a soaking agent and follow steps under “Soaking” or soak overnight to remove stains and soils. • Always follow manufacturer’s instructions with any pretreatment product. 	<ul style="list-style-type: none"> • Do not use a soaking agent with chlorine bleach. • Do not use pretreaters around the washer or dryer control panel. They may harm the finish or panel markings.
Detergents/ Soaps	<ul style="list-style-type: none"> • You may use detergent or soap in your washer. The determining factor is the hardness of the water. Always use detergent if the water is over three grains hard. 	<ul style="list-style-type: none"> • Soap and nonphosphate powdered detergents will not give good washing results in hard water. Soap in hard water will form sticky deposits. • The use of powdered soap is not recommended when washing in cold water.
Bleaches	<ul style="list-style-type: none"> • Use to remove certain stains, disinfect, and keep clothes white. • Use bleach in the wash water only. Do not use bleach in the rinse. • Follow directions on care label of garment. • Bleach should not be used as a substitute for detergent. Use the recommended amount of bleach. 	<ul style="list-style-type: none"> • When using liquid chlorine bleach, always use the bleach dispenser. • Always measure the bleach. Never exceed one cup of bleach per full load. • Never use chlorine bleach and ammonia in the same wash cycle.
Fabric Softeners	<ul style="list-style-type: none"> • Use to soften clothes and remove static electricity from permanent press knits and other fabrics of man-made fibers. • Use the fabric softener dispenser on your machine (if your machine has it), or add during the rinse cycle, using no other product in the rinse. Follow bottle directions carefully. 	<ul style="list-style-type: none"> • Undiluted fabric softener poured directly on clothes can stain them. • Do not mix with detergent or bleach.
Water Conditioners Non-Precipitating Type Precipitating Type	<ul style="list-style-type: none"> • These products soften water by tying up the hardness minerals. Recommended if using soap with water over three grains hard, or when using nonphosphate detergents. • These products settle out hardness minerals by converting them into particles that will not dissolve in the water. If used with nonphosphate detergent or soap in hard water, a deposit may form on the clothes and washer parts. 	<ul style="list-style-type: none"> • Do not use with nonphosphate detergents or soaps.

Washing Temperature Guide . . .

Water Temperature	Use	Comments
HOT (approx. 140° F)	<ul style="list-style-type: none"> • Sturdy whites and colorfast items. • Work clothes. • Soiled items. • Diapers. 	<ul style="list-style-type: none"> • Best cleaning for heavily soiled items. • Reduces wrinkling.
WARM (approx. 100° F)	<ul style="list-style-type: none"> • Light and moderately soiled items. • Non-colorfast or dark colors. • Permanent press. • Silks, woolens, nylon, acrylic. 	<ul style="list-style-type: none"> • Reduces wrinkling. • Less fading.
COLD (approx. 65° F)	<ul style="list-style-type: none"> • Rinsing of all items. • Non-colorfast fabrics. • Extra sensitive clothing. 	<ul style="list-style-type: none"> • Saves energy. • Reduces color fading.

Bleach Dispenser

The bleach dispenser is located in the left front corner, under the loading door.

Use liquid bleach in the dispenser.

Use no more than one cup chlorine bleach for large loads, three-quarters cup for medium and one-half cup for small loads.

Carefully pour recommended amount of bleach into the dispenser during the first fill of the washer.

Be careful not to spill undiluted bleach. It is a strong chemical and can damage some fabrics if it is not properly diluted.

Powdered bleach must not be used in the bleach dispenser. Add powdered bleach to the wash water.

Agitator Cap

IMPORTANT: The agitator must have either the cap or Fabric Softener Dispenser on it at all times.

Fabric Softener Dispenser and Agitator (Not on all models)

To Use Dispenser

After the clothes are loaded into the washtub and before the start of the WASH CYCLE, pour the proper amount of liquid fabric softener into the bottle measuring cap (see bottle directions). Pour into dispenser.

The large fabric softener dispenser allows for the fabric softener to be diluted with water. We recommend adding water up to the fill level. Do not exceed tip of arrow which indicates correct fill level. Over-filling can allow fabric softener to spill onto the clothes.

Setting the water level to medium or higher will result in better performance from the fabric softener. The fabric softener will remain in the dispenser during the wash fill, agitation, and spin. At the end of the wash spin, the liquid fabric softener will be dispensed into the washtub through the slots in the agitator and will be mixed with the incoming rinse water.

To Clean the Dispenser

Remove the dispenser housing from agitator by squeezing the lower part of the dispenser, pulling directly upward and at the same time tilting slightly. This will expose the dispenser cup, which is also removable for cleaning (refer to illustration). Both housing and cup can be soaked in hot soapy water and rinsed clean. The funnel shape in top of agitator also needs to be cleaned. The hole and the slots in the two rings will require using a small brush for proper cleaning.

After cleaning, install dispenser cup, then push dispenser housing directly downward onto top of agitator until firmly snapped together.

Use Tips

- Fabric softener spilled onto garments may cause staining. To remove, soak in a soapy solution made from Ivory or Camay soap, or rub the stain with a bar of either of these soaps. Then wash.
- Liquid fabric softener will be dispensed during the final rinse and should not be combined with bleach, bluing, starch, detergents, soaps or packaged water conditioners during this rinse.
- Fabric softener is not to be used in dispenser when using Soak/Prewash cycle.
- When adding detergent to wash water, do not allow any to enter into softener dispenser cup, as softener will become gummy.

To prevent softener buildup, the dispenser can be filled with clean water for automatic cleaning. This can be done in washing cycles other than when softener is used.

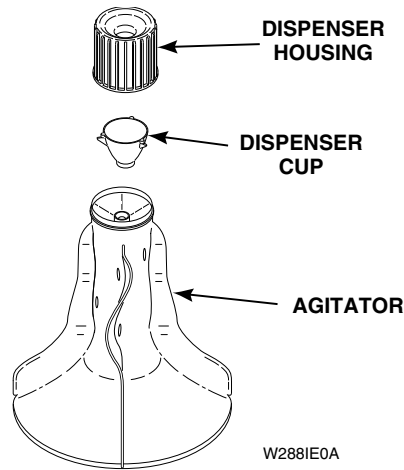

How To Use Your Washer . . .

Operation Instructions

▲ WARNING

To reduce the risk of fire, electric shock, serious injury or death to persons, read the **IMPORTANT SAFETY INSTRUCTIONS**, Pages 3 and 4, before operating the washer.

Determine Proper Cycle

Regular

Use for sturdy items, like play or work clothes, towels, T-shirts, etc. The wash time selection will depend on the type of fabric and the amount of soil. For the best results when cleaning heavily soiled items, use a longer wash time (15 minutes maximum). Lightly soiled items require less wash time.

There are three settings in the REGULAR cycle — heavy, normal and light. The number shown next to these settings is the length of agitation in minutes. (For example: setting the timer on Heavy will be a 15 minute agitation).

Permanent Press

Use for permanent press items and synthetics. The wash time selection will depend upon the type of fabric and amount of soil.

There are two settings in the PERMANENT PRESS cycle — normal and light. The number shown next to these settings is the length of agitation in minutes. (For example: setting the timer on Normal will be a nine minute agitation).

The PERMANENT PRESS cycle automatically cools the temperature of the fibers before the spin. After wash the agitation stops, the washtub spins slowly, partially drains and then stops. Cold water will then be automatically added to the washtub until the proper water level is reached. This happens one or two times, depending on the size of the load and type of drain connection. When the COOL DOWN is complete, the washer will pause for approximately one minute before continuing the cycle.

Delicate

Wash delicate items usually washed by hand on this cycle. A full tub of warm water is recommended (even for small loads) to allow the delicate items to move freely through the water. More water helps reduce fabric wear, wrinkling, and provides for a clean wash.

There are two settings in the DELICATE cycle — normal and light. The number shown next to these settings is the length of agitation in minutes. (For example: setting the timer on Normal will be an eight minute agitation, including pauses).

To Wash Clothes

IMPORTANT: Before using your new washer, make sure the washer cord is plugged into a 120 Volt electrical outlet that has the proper grounding and polarity, that the washer hoses are connected to the hot and cold water faucets, and that the faucets are turned on. Be sure the drain hose is not kinked and is inserted into a drain. See the **INSTALLATION INSTRUCTIONS** for details of proper washer installation.

IMPORTANT: Before using the washer for the first time, wipe out the inside of the wash tub with a sudsy cloth.

1. Get the clothes ready for washing. Empty pockets and cuffs. Sort items into separate loads. Pretreat stains and heavily soiled areas.
2. Measure and add detergent to the washtub.
3. Add clothes loosely into the washtub. The bulk of the clothes rather than the weight will determine load size.
4. Close the loading door. The washer will not agitate or spin with the loading door open.

▲ WARNING

To reduce the risk of serious injury, **DO NOT** by-pass the loading door switch by permitting the washer to agitate or spin with the loading door open.

5. Set WASH/RINSE temperatures.

WASH/RINSE TEMP

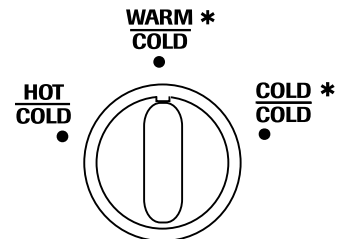

*ENERGY SAVER
CPW40-IN-1

NOTE: The washer will provide a cold rinse in all TEMPERATURE settings. Cold rinses will save you money and energy and will help reduce wrinkling in permanent press and synthetics.

The Energy Saver settings, marked with an asterisk (*), show which temperature settings will use the least energy.

(continued)

- Set LOAD SIZE (WATER LEVEL) control. Use RESET if agitation has started and more water is needed.

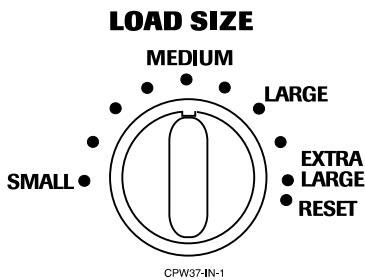

IMPORTANT: Holding the LOAD SIZE (WATER LEVEL) control in the RESET position can cause flooding of the washer.

- Select the cycle according to the type of fabric being washed. Push the timer knob in and turn clockwise to the desired cycle and wash time.
- Pull the timer knob out to start the water fill. Agitation will begin when the water reaches the level you selected.

The washer will stop (pause) for approximately two minutes before the wash and rinse spins. Do not turn the timer through these pauses. They are part of the cycle.

Soaking

Set the timer knob in the center of the word "RINSE" or the washer may spin without first filling with water. Place the soaking product and clothes load in the washtub. Pull timer knob to start water fill. After fill is completed and agitation has started, push the timer knob in. This will stop the washer. When the clothes have soaked the desired length of time, TURN THE TIMER KNOB TO THE START OF THE LAST SPIN, then pull the timer knob out to start the spin.

Timer

Although the washer cycles are automatic, the timer may be reset to lengthen, shorten, or repeat a portion of a cycle.

To set or reset the timer, push timer knob in to stop the washer. Hold timer knob in firmly while turning it clockwise to the setting desired. Pull timer knob out to start the washer.

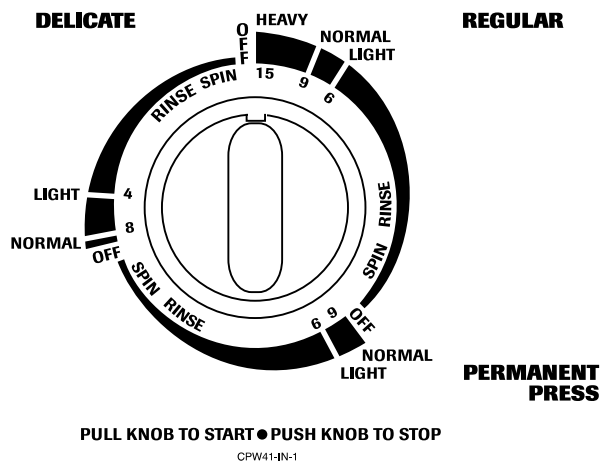

PULL KNOB TO START • PUSH KNOB TO STOP

Special Care . . .

Starching

Starching adds crispness and body to fabrics, enhances soil resistance, and makes ironing easier. There are several types of starches. Carefully follow label directions for spray or hand starching or starching in the washer.

Knits

A variety of knits are being used for many types of clothing and household furnishings. Many knits are machine washable, some are hand washable, and some must be dry-cleaned. When buying, make sure the garment has a care label with care instructions. These directions must be followed. Some knits are stretched during their manufacture and may shrink or relax when exposed to water.

Cotton Knits

Unless the label indicates that it is preshrunk, cotton knits will probably shrink to some degree. Overdrying contributes to shrinkage of cotton knits.

Wash water should be hot or warm suitable for color and soil. The rinse water should be cold.

Rayon Knits

Rayon stretches and shrinks easily. Treat as a delicate fabric and wash gently.

Synthetic Fiber Knits

Knits made from synthetic fibers or blends containing a high percentage of synthetics will generally keep their shape. When buying, make sure the trimmings (including belts) are machine washable, seams are not puckered, and zippers and trimmings are well fastened.

Knits of Man-Made Fibers

In general, follow the rules for permanent press fabrics as they tend to have the same characteristics. Set machine to PERMANENT PRESS cycle. Set the wash water warm, or suitable for color and soil. Rinse water should be cold. Do not wash with lint-shedding fabrics. Separate items for color, washing whites separately.

Sweaters of Man-Made Fibers

Follow directions for knits. Button sweaters and turn inside out. The ribbon behind the buttons and button holes may shrink. Stretch to shape after washing. Orlon sweaters may stretch. Avoid pulling them when wet. Dryer dry.

Wool Sweaters

Loosely knit or delicately constructed sweaters will need delicate care. Hand wash. Measure garment before and after washing. Squeeze gently through the water with little motion. Rinse thoroughly. Block to shape and dry flat.

For sweaters labeled "machine washable", follow manufacturer's directions or use warm water wash and cold rinse. Dry flat. Excess agitation and excess tumbling are the main causes of wool shrinkage.

Wool Knits

Dry-clean wool knits unless labeled machine washable. Follow manufacturer's directions.

(continued)

Permanent Press

Permanent or durable press garments and household items will usually not need pressing when washed and dried properly. However, some will be more wrinkle resistant than others.

The care needed for permanent press is a little different than for cottons. Permanent press will soften or become pliable when heated. This softening when it is in warm or hot wash water will allow wear wrinkles to be removed. It will also cause the fabric to wrinkle if it is crushed, squeezed or spun when hot.

Permanent press cycles of washers, when washer controls are properly set, will cool the clothes before the wash spin to avoid wrinkling. Because the clothes soften when heated, it is important to remove them from the dryer as soon as tumbling stops.

How To Wash Permanent Press

1. Wash often. Permanent press clothes tend to look clean even when they should be washed.
2. Sort loads correctly, refer to Page 5.
3. Do not wash with lint-shedding loads. Permanent press attracts lint in the wash water.
4. Pre-treat grease stains and oily areas. This is especially important for shirt collars and cuffs. Rub liquid detergent or a paste of detergent into the area.

5. Use the PERMANENT PRESS cycle, hot or warm water, cold rinse and sufficient detergent.
6. Use fabric softener in the rinse water. This will reduce the static electricity which attracts lint and makes garments cling.

To Dry Permanent Press

For best results, permanent press should be dryer dried. See garment care labels. Ironing may be necessary. Use low heat setting on iron or steam setting on a steam iron.

Washing Special Items . . .

Always Follow Manufacturer's Care Label Instructions

Bedding	<ul style="list-style-type: none"> • Warm wash and rinse. • PERMANENT PRESS cycle. • Pretreat heavily soiled areas before washing. • When washing an electric blanket, protect the plug by stitching the edge of the blanket over the plug. Only dryer dry if manufacturer says it can be done.
Diapers	<ul style="list-style-type: none"> • Rinse out diapers immediately in cold water and soak in a diaper pail with a small amount of detergent or enzyme presoak. Soak before washing. • Limit wash load to two dozen diapers. • Recommend an all-purpose detergent.
Draperies, Curtains, Slip Covers	<ul style="list-style-type: none"> • Shake to remove dust. Remove hooks and close zippers. • Sun-damaged draperies and curtains will not withstand washing. Use warm water. • Wash curtains frequently. They can be weakened from soil, fumes, dust, and the sun. • Fiberglass curtains need gentle care. Read care label to see if washable. Some fiberglass curtains should be hand washed.
Pillows (Feather and down)	<ul style="list-style-type: none"> • Do not wash pillows unless they can be dryer dried. They may mildew if not dried completely. • Wash two pillows at a time or add towels for balance. • Use warm wash and detergent.
Rugs	<ul style="list-style-type: none"> • Shake before washing. Do not use hot water on rubber-backed rugs. • Wash two or three rugs to balance the washer. • Fabric softener in the rinse will help eliminate static.
Slips and Gowns	<ul style="list-style-type: none"> • Wash often using all-purpose detergent, warm or hot water and cold rinse on the PERMANENT PRESS cycle. • To keep nylons and polyesters white, wash only with whites and use chlorine bleach occasionally. • Use fabric softener in the rinse to remove static electricity.

Washing Problems . . .

To keep clothes looking white or bright, use good washing practices at all times to prevent a gradual build-up of soil or water hardness minerals on them. If you notice that your clothes are not as bright as they should be, take corrective measures immediately.

Problem	Cause	Solution
Gray or Dingy Clothes	Insufficient Detergent	Add more detergent to washtub before loading clothes. Mild detergents are not suitable for average soil.
	Improper Sorting	Wash whites separately. Separate light from heavily soiled items. Clothes can pick up soil from dirty wash water.
	Nonphosphate Detergent and Hard Water	Follow package directions. Soften water if possible, and use a phosphate detergent.
	Water Not Hot Enough	White clothes will stay whiter with hot wash water. Increase temperature.
	Overcrowding Washer	Clothes must circulate freely through the water for best results.
Yellowed Clothes	Unremoved Soil	Skin soil is hard to remove. Check hem edge of sheets and pillowcases, bottom end of t-shirts, etc. If this portion is white and center is yellow, the fabric contains unremoved soil. Use sufficient detergent and a hot wash. Chlorine bleach may be needed.
	Clothes Stained From Iron In The Water	To test if an iron stain, use a rust remover on a portion of the garment. Follow bottle directions for larger items.
	Older Clothes	Some white fabrics turn yellow with age and cannot be whitened.
Clothes Tearing or Damage	Improper Use of Chlorine Bleach	No correction for bleach damaged clothes. Always measure and dilute bleach.
	Overcrowding or Overloading	Make sure all items can move freely during agitation.
	Insufficient Pre-care	Fasten all hooks and zippers. Mend tears. Remove objects from pockets.
Excessive Lint	Improper Sorting	Fabrics which shed lint should not be washed with fabrics that receive lint.
	Insufficient Detergent / Nonphosphate Detergent	Use enough detergent so lint remains suspended in water and flushed out.
	Mixing Fabric Types	Knits and Permanent Press attract lint. Wash these only with similar items. Use fabric softener in rinse water.

Stain Removal . . .

Many soils will not become stains if treated promptly. Older stains may be difficult or impossible to remove. Hot water will set some stains, particularly protein based stains. Use cold or warm water on these before washing in hot water.

▲ WARNING

Never put highly flammable substances like gasoline, kerosene, waxes, vegetable oils, cooking oils, etc. into a washer or dryer. Never put articles that have been cleaned with such substances into a washer or dryer. Failure to comply with these warnings could result in a fire, explosion, and/or serious burns or death. All items with these substances on them should be thoroughly hand-washed with a detergent so that no trace of the flammable substances remains. The articles can then be machine washed and/or dried.

When using any kind of a dry-cleaning fluid, follow the manufacturer's recommendations. The fumes should never be inhaled. Use in a well ventilated room away from sparks and flames. Air dry before washing or drying. Dry-cleaning fluid may cause a "ring" to be formed on some permanent press fabrics. This will not wash out. To remove, clean the garment in a coin-operated dry-cleaning unit, or by a professional dry-cleaner.

Stain	Treatment
Adhesive Tape	Place face down on paper towels and sponge with a dry-cleaning solvent (see WARNING above). Launder.
Airplane Glue	Place face down on paper towels and sponge with fingernail polish remover until stain dissolves. Launder.
Alcoholic Beverages	Sponge stain immediately with cold water or soak stain 30 minutes in cold water. Apply detergent to any trace of stain while still wet. If safe for the fabric, launder in hot water using chlorine bleach.
Blood	Treat stain immediately. Soak 30 minutes or more in cold water. Rub detergent into stain. If stain persists, place a small amount of household ammonia on the stain and rub again with detergent. If safe for fabric, launder in hot water and chlorine bleach if traces of the stain persist.
Candlewax	Rub with ice and scrape off excess wax. Place stain between paper towels and press with warm iron. Then place stain face down on paper towels and sponge with dry-cleaning solvent (see WARNING above). Let dry, launder. If traces of color remain, launder with a commercial color remover, or if safe for the fabric, hot water and chlorine bleach.
Catsup, Tomato-Based Products	Scrape off excess. Soak in cold water 30 minutes. Rub detergent into the stain and if safe for fabric, launder in hot water and chlorine bleach.
Chewing Gum	Rub with ice and scrape off excess gum. Place face down on paper towels and sponge with a dry-cleaning solvent.
Cocoa or Chocolate	Soak in cold water. Rub detergent into stain, rinse. If greasy stain remains, sponge face down on paper towels with a dry-cleaning solvent. If traces of the stain remains, launder in hot water and chlorine bleach (if safe for fabric).
Coffee, Tea	Soak in cold water. Rub detergent into stain, rinse. If traces of the stain remain, launder in hot water with chlorine bleach (if safe for fabric).
Crayon	Treat the same as candle wax (above) or wash in hot water (if safe for fabric) using soap (not a detergent) and 1-2 cups baking soda. If stains remain, professional dry-cleaning may be necessary.

(continued)

Stain	Treatment
Deodorants and Anti-Perspirants	Some of these products contain substances that can change the color of some dyes. The color can sometimes be restored if the area is sponged with ammonia then rinsed. To remove stains, apply white vinegar. Rub, rinse. If stains remain, rub detergent into stain and launder with hot water and chlorine bleach (if safe for fabric).
Dye	Treat with a commercial dye remover (Rit, Putnam) or if safe for fabric, bleach with chlorine bleach.
Egg	If dried, scrape off excess. Soak in cold water. Rub detergent into damp stain and if safe for fabric, launder in hot water and chlorine bleach.
Fabric Softener	Dampen stain and rub with bar soap. Launder as usual.
Fruit Juices	Soak in cold water. Launder in hot water with chlorine bleach (if safe for fabric).
Grease, Oil	Place face down on paper towel and sponge with dry-cleaning fluid (see WARNING on Page 17). Dampen stain with water and rub with bar soap or detergent. Launder in hot water (if safe for fabric).
Ink	Saturate the stain with hair spray or place the fabric face down on paper towel and sponge with cleaning fluid or rubbing alcohol (see WARNING on Page 17). Rinse. If traces of the stain remain, rub detergent into the dampened stain and launder. Some inks may be impossible to remove.
Iodine	Rinse from the back side of the stain with cold water. Then soak in a commercial color remover (Rit, Putnam, etc.) or rub in a paste of water and starch. Let stand for 15-30 minutes and launder.
Lipstick	Place on paper towel and sponge with cleaning fluid (see WARNING on Page 17). Rinse. Rub dampened stain with bar soap and launder.
Mildew	Treat promptly. Mildew damages fabric and sometimes cannot be removed. Launder with chlorine bleach. For items that cannot be washed with chlorine bleach, soak in an all-fabric bleach, then launder.
Milk and Milk Products	Soak in cold water. Launder in hot water and chlorine bleach (if safe for fabric). Sponge with a cleaning fluid (see WARNING on Page 17), if a stain is noticeable. Rewash.
Miscellaneous Eye and Face Make-up, Tar, Gravy, Felt-Tip Marker, Pitch, Typewriter Ribbon	(A) Place stain side down on paper towel and sponge with dry-cleaning fluid (see WARNING on Page 17). (B) Apply dry spotter (one part mineral water and eight parts dry-cleaning solvent). Use a spoon to loosen stain. Keep stain moist with dry spotter and blot occasionally with toweling. Continue until stain is removed. Allow to dry completely, rinse in warm water, and launder as usual.
Mud	Scrape off excess. Soak in solution of one quart warm water, half teaspoon liquid hand dishwashing detergent and one tablespoon vinegar for 15 minutes. Rinse. Launder in hot or warm water with enzyme product.
Mustard	Rub dampened stain with bar soap. Launder in hot water and chlorine bleach (if safe for fabric).
Nail Polish	Place face down on paper towel. Sponge with nail polish remover (non-oily) until stain disappears. Launder. Do not use nail polish remover on Acetate or Arnel fabrics.

Stain	Treatment
Paint	Water-based — Treat by rinsing fabric in cool water while stains are still wet. Then launder. Dried paint cannot be removed. Oil-based — Pretreat with a solvent recommended on the paint container. If not available, use mineral spirits. Rinse. Pretreat with a stain remover or detergent, rinse and launder.
Perspiration	Rub dampened stain with detergent. Launder in hot water and chlorine bleach (if safe for fabric). If the fabric is discolored, you can try to restore it by treating fresh stains with ammonia or old stains with vinegar.
Rust	Apply a commercial rust remover (Whink, Rit, RoVer, etc.) Follow manufacturer's directions. Then launder as usual.
Scorching	Launder using hot water and chlorine bleach (if safe for fabric). Fabrics can be damaged by being scorched. If this has happened, you may not be able to remove the marks.
Shoe Polish	Rub dampened stain with detergent. Launder in hot water and chlorine bleach if safe for fabric.
Soft Drinks	Rinse stain with cold water immediately. Launder in warm water and chlorine bleach if safe for fabric.
Tobacco	Dampen stain and rub with bar soap. Rinse. If necessary, soak in an all-fabric bleach solution. If stain remains, launder with chlorine bleach (if safe for fabric).
Urine	Rinse with cold water. Soak with an enzyme soaking product. Launder in hot water with chlorine bleach (if safe for fabric). If the color of the fabric has changed, sponging the area with ammonia may restore the color.
Vomit	Soak in a solution of one quart warm water, half teaspoon liquid hand dishwashing detergent, and one tablespoon ammonia (if safe for fabric). Soak 15 minutes. Use sponge to loosen stain. Blot with toweling. Launder in hot water (if safe for fabric) with an enzyme product.

Maintenance . . .

Cold Weather Care

If the washer is delivered on a cold day (below freezing), or is stored in an unheated room or area during the cold months, do not attempt to operate it until the washer has had a chance to warm up.

Care Of Your Washer

IMPORTANT: Before using the washer for the first time, wipe out the inside of the washtub with a sudsy cloth.

Use only a damp or sudsy cloth for cleaning the control panel. Some spray prewash products may harm the finish on the control panel.

Wipe the washer cabinet as needed. If detergent, bleach or other washing products are spilled on the cabinet, wipe immediately. Some products will cause permanent damage if spilled on the cabinet.

Do not use scouring pads or abrasive cleansers.

Do not lay sharp or rough objects on or against the washer. The finish could be damaged.

The washtub will need no particular care though it may need rinsing or wiping after an unusual load has been washed. This also may be necessary if too little detergent has been used.

Leave the loading door open to allow the inside of the washer to dry out after use. This helps prevent musty odors from developing.

Vacations and Extended Non-Use

IMPORTANT: To avoid possible property damage due to flooding, turn off the water supply to the washer whenever there will be an extended period of non-use.

Operating Tips . . .

Out-Of-Balance Switch

The out-of-balance switch is located behind the right rear hinge of the washer loading door.

A load of one or two items can make the washtub unbalanced during the spin periods. For the best spinning results, the load must be balanced throughout the spin period.

The out-of-balance switch is tripped if the load becomes excessively unbalanced during the spin. Spinning stops when this happens.

If the out-of-balance switch is tripped, you will need to rearrange the load. To do this, push the timer knob in, open the loading door and evenly distribute the items in the washtub. Close the loading door, pull the timer knob out, and the spin will resume.

Motor Overload Protector . . .

This internal overload protector will stop the motor automatically in the event of an overload. The overload protector will reset itself in two or three minutes and the

motor will reset automatically. If the overload protector stops the motor again, remove the washer from use and call the serviceman to correct the problem.

Before You Call For Service . . .

(You may save time and money by checking the following):

• If Your Washer:

Won't Fill	Won't Start	Won't Agitate	Won't Spin	Possible Reason — Do This To Correct
•	•	•	•	Be sure the power cord is plugged all the way into the electrical outlet.
	•	•	•	Close the loading door.
•	•	•	•	Check the house fuse or circuit breaker.
	•			Has the motor overload protector cycled?
•				Turn on the hot and cold water faucets.
	•			Pull timer knob out to start the washer.
•			•	Was the last spin completed?
•				Clean the filter screens located at the faucet end of the inlet hoses. Owner is responsible for service call regarding cleaning of the screens.
•				Water is siphoned from the washer during the cycle. Refer to the INSTALLATION INSTRUCTIONS supplied with the washer.
•	•			Are the controls properly set?
		•	•	Broken drive belt. Call the serviceman.

If Service Is Required . . .

If service is required, contact the nearest Factory Authorized Service Center.

If you are unable to locate an authorized service center or are unsatisfied with the service performed on your washer, write to:

Raytheon Appliances
Amana Home Appliance
Division
2800 220th Trail
P.O. Box 8901
Amana, Iowa 52204-0001
Phone: 1-800-843-0304
FAX: (319) 622-8158
Monday through Friday
7:00 a.m. to 6:00 p.m.
Central Time Zone

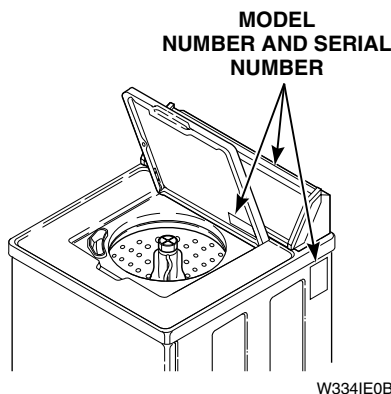

When calling or writing about your washer, PLEASE GIVE THE MODEL AND SERIAL NUMBERS. The model and serial numbers are located on the nameplate. The nameplate will be in the location shown. Please include a copy of your bill of sale and any service receipts you have.

▲ WARNING

To reduce the risk of serious injury or death, DO NOT repair or replace any part of the washer or attempt any servicing unless specifically recommended in the user-maintenance instructions or in published user-repair instructions that you understand and have the skills to carry out.

Information For Handy Reference . . .

Consumer Affairs Department
Amana Refrigeration, Inc.
2800 220th Trail
P. O. Box 8901
Amana, Iowa 52204-0001

Date Purchased _____

Model Number _____ Serial Number _____

Dealer's Name _____

Dealer's Address _____ Phone Number _____

Service Agency _____

Service Agency Address _____ Phone Number _____

Record this information and keep your sales slip. Model and serial numbers are located on the nameplate.

Speed Queen
A **Raytheon** Company

Free Manuals Download Website

<http://myh66.com>

<http://usermanuals.us>

<http://www.somanuals.com>

<http://www.4manuals.cc>

<http://www.manual-lib.com>

<http://www.404manual.com>

<http://www.luxmanual.com>

<http://aubethermostatmanual.com>

Golf course search by state

<http://golfingnear.com>

Email search by domain

<http://emailbydomain.com>

Auto manuals search

<http://auto.somanuals.com>

TV manuals search

<http://tv.somanuals.com>