

STANLEY®

RS25 HYDRAULIC RAIL SAW



USER MANUAL Safety, Operation and Maintenance



© 2014 Stanley Black & Decker, Inc.
New Britain, CT 06053
U.S.A.
31846 8/2014 Ver. 11

DECLARATION OF CONFORMITY

DECLARATION OF CONFORMITY
 ÜBEREINSTIMMUNGS-ERKLÄRUNG
 DECLARATION DE CONFORMITE CEE
 DECLARACION DE CONFORMIDAD
 DICHIARAZIONE DI CONFORMITA



I, the undersigned:
 Ich, der Unterzeichnende:
 Je soussigné:
 El abajo firmante:
 Io sottoscritto:

Weisbeck, Andy

Surname and First names/Familiennamen und Vornamen/Nom et prénom/Nombre y apellido/Cognome e nome

hereby declare that the equipment specified hereunder:
 bestätige hiermit, daß erklaren Produkt genannten Werk oder Gerät:
 déclare que l'équipement visé ci-dessous:
 Por la presente declaro que el equipo se especifica a continuación:
 Dichiaro che le apparecchiature specificate di seguito:

1. Category: **Rail Saw, Hydraulic**
 Kategorie:
 Catégorie:
 Categoria:
 Categoría:

2. Make/Marke/Marque/Marca/Marca **Stanley**

3. Type/Typ/Type/Tipo/Tipo: **RS25103**

4. Serial number of equipment:
 Seriennummer des Geräts:
 Numéro de série de l'équipement:
 Numero de serie del equipo:
 Matricola dell'attrezzatura:

All

Has been manufactured in conformity with
 Wurde hergestellt in Übereinstimmung mit
 Est fabriqué conformément
 Ha sido fabricado de acuerdo con
 E' stata costruita in conformità con

Directive/Standards Richtlinie/Standards Directives/Normes Directriz/Los Normas Direttiva/Norme	No. Nr Numéro No n.	Approved body Prüfung durch Organisme agréé Aprobado Collaudato
EN ISO	3744:2009	Self
ISO	20643:2005	Self
ISO	19432:2006	Self
Machinery Directive	2006/42/EC:2006	Self

5. Special Provisions: **None**
 Spezielle Bestimmungen:
 Dispositions particulières:
 Provisiones especiales:
 Disposizioni speciali:

6. Representative in the Union: **Patrick Vervier, Stanley Dubuis 17-19, rue Jules Berthonneau-BP 3406 41034 Blois Cedex, France.**
 Vertreter in der Union/Représentant dans l'union/Representante en la Union/Rappresentante presso l'Unione

Done at/Ort/Fait à/Dado en/Fatto a Stanley Hydraulic Tools, Milwaukie, Oregon USA Date/Datum/le/Fecha/Data 1-4-11

Signature/Unterschrift/Signature/Firma/Firma

Position/Position/Fonction/Cargo/Posizione Engineering Manager

TABLE OF CONTENTS

DECLARATION OF CONFORMITY	2
SAFETY SYMBOLS	4
SAFETY PRECAUTIONS.....	5
TOOL STICKERS & TAGS	7
HOSE TYPES.....	8
HOSE RECOMMENDATIONS	9
FIGURE 1. TYPICAL HOSE CONNECTIONS	9
HTMA REQUIREMENTS.....	10
OPERATION.....	11
FIGURE 2.....	12
FIGURE 3.....	12
TOOL PROTECTION & CARE	14
TROUBLESHOOTING	15
SPECIFICATIONS.....	16
ACCESSORIES.....	16
RS25 PARTS ILLUSTRATION	17
RS25 PARTS LIST	18

IMPORTANT

To fill out a Product Warranty Validation form, and for information on your warranty, visit Stanleyhydraulics.com and select the Company tab, Warranty.
(NOTE: The warranty Validation record must be submitted to validate the warranty).

SERVICING: This manual contains safety, operation, and routine maintenance instructions. Stanley Hydraulic Tools recommends that servicing of hydraulic tools, other than routine maintenance, must be performed by an authorized and certified dealer. Please read the following warning.

⚠ WARNING

SERIOUS INJURY OR DEATH COULD RESULT FROM THE IMPROPER REPAIR OR SERVICE OF THIS TOOL.

REPAIRS AND / OR SERVICE TO THIS TOOL MUST ONLY BE DONE BY AN AUTHORIZED AND CERTIFIED DEALER.

For the nearest authorized and certified dealer, call Stanley Hydraulic Tools at the number listed on the back of this manual and ask for a Customer Service Representative.

SAFETY SYMBOLS

Safety symbols and signal words, as shown below, are used to emphasize all operator, maintenance and repair actions which, if not strictly followed, could result in a life-threatening situation, bodily injury or damage to equipment.



This is the safety alert symbol. It is used to alert you to potential personal injury hazards. Obey all safety messages that follow this symbol to avoid possible injury or death.

This safety alert and signal word indicate an imminently hazardous situation which, if not avoided, will result in death or serious injury.



This safety alert and signal word indicate a potentially hazardous situation which, if not avoided, could result in death or serious injury.



This safety alert and signal word indicate a potentially hazardous situation which, if not avoided, could result in death or serious injury.



This signal word indicates a potentially hazardous situation which, if not avoided, may result in property damage.



This signal word indicates a situation which, if not avoided, will result in damage to the equipment.



This signal word indicates a situation which, if not avoided, may result in damage to the equipment.

Always observe safety symbols. They are included for your safety and for the protection of the tool.

LOCAL SAFETY REGULATIONS

Enter any local safety regulations here. Keep these instructions in an area accessible to the operator and maintenance personnel.

SAFETY PRECAUTIONS

Tool operators and maintenance personnel must always comply with the safety precautions given in this manual and on the stickers and tags attached to the tool and hose.

These safety precautions are given for your safety. Review them carefully before operating the tool and before performing general maintenance or repairs.

Supervising personnel should develop additional precautions relating to the specific work area and local safety regulations. If so, place the added precautions in the space provided in this manual.

The model RS25 Hydraulic Rail Saw will provide safe and dependable service if operated in accordance with the instructions given in this manual. Read and understand this manual and any stickers and tags attached to the tool and hose before operation. Failure to do so could result in personal injury or equipment damage.



- The operator must start in a work area without bystanders. Flying debris can cause serious injury.
- Do not operate the tool unless thoroughly trained or under the supervision of an instructor. Establish a training program for all operators to ensure safe operation.
- Always wear safety equipment such as goggles, gloves, ear and head protection, and safety shoes at all times when operating the tool.
- The operator must be familiar with all prohibited work areas such as excessive slopes and dangerous terrain conditions.
- Maintain proper footing and balance at all times.
- Do not inspect or clean the tool while the hydraulic power source is connected. Accidental engagement of the tool can cause serious injury.
- Always connect hoses to the tool hose couplers before energizing the hydraulic power source. Be sure all hose connections are tight and are in good condition.
- Do not operate the tool at oil temperatures above 140 °F/60 °C. Operation at higher temperatures can cause higher the normal temperatures at the tool which can result in operator discomfort.
- Do not operate a damaged, improperly adjusted, or incompletely assembled tool.
- Never wear loose clothing that can get entangled in the working parts of the tool.
- Keep all parts of your body away from the rotating parts. Long hair or loose clothing can become drawn into rotating components.
- Always use accessories that conform to the specifications given in the OPERATION section of this manual.
- Do not operate the tool with the wheel guard removed.
- Release the trigger if the power supply has been interrupted.
- Keep the wheel off all surfaces when starting the rail saw.
- To avoid personal injury or equipment damage, all tool repair, maintenance and service must only be performed by authorized and properly trained personnel.
- Always hold the tool with both hands when the unit is running. Use a firm grip.
- Make sure the wheel has stopped before setting the tool down. Always carry the tool with the wheel stopped.
- Inspect the wheel guard and collars for damage after any wheel breakage.
- Do not operate the tool in the vicinity of flammable materials.
- Never exceed the maximum operating speed marked on the wheel.
- Do not attempt to adjust the flow control in the valve handle.
- Eye injury and cutting or severing of body parts is possible if proper procedures are not followed.

SAFETY PRECAUTIONS

CUTTING WHEEL SAFETY

- Do not store or transport the saw with the wheel installed.
- Ensure that the cutting wheel is correctly mounted and tightened before use.
- Operate the Rail Saw at “no load” for 30 seconds in a safe position and ensure there is no vibration or other defects detected. If considerable vibration or other defects are detected, stop operation of the tool immediately and determine the cause. Do not use the tool until the defect is corrected.
- If the Rail Saw is dropped with a cutting wheel installed, the cutting wheel should be examined thoroughly before use.
- Only use cutting wheels that comply with ANSI B7.5/ISO 525, 603.
- Check that the maximum operating speed (rpm – revolutions per minute) of the cutting wheel is equal to or greater than the rated shaft speed of the grinder. Stanley recommends wheels rated at 4700 RPM for 16 inch models and 5300 RPM for 14 inch models.

TOOL STICKERS & TAGS

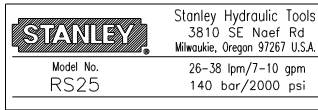

28728
RS25 Name Tag

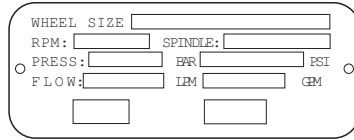

28811
Information Plaque
(CE models only)



05868
Abrasive Cut-Off Safety Label
(14 inch models only – except CE)



03787
GPM Sticker 7-9 2000 PSI



28409
Composite Sticker
(CE models only)



17641
Abrasive Cut-Off Safety Label
(16 inch models only)



25610
Railroad Help Desk Sticker



11207
Sound Power Level Sticker

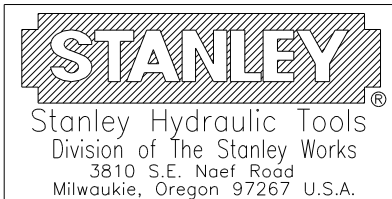

05152
Logo-Address Decal
(UP models only)

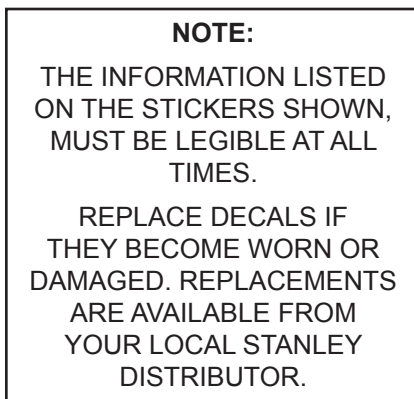

The safety tag (P/N 15875) at right is attached to the tool when shipped from the factory. Read and understand the safety instructions listed on this tag before removal. We suggest you retain this tag and attach it to the tool when not in use.

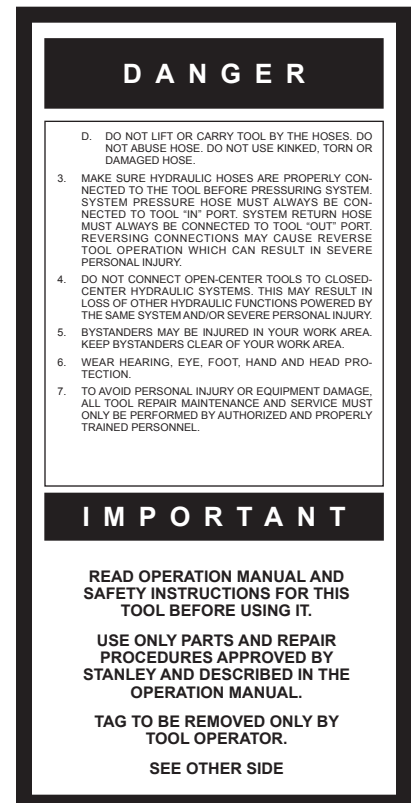
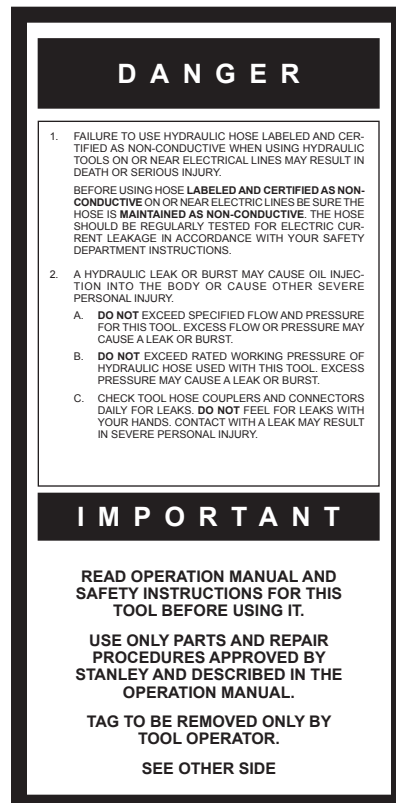

SAFETY TAG P/N 15875 (Shown smaller than actual size)

HOSE TYPES

The rated working pressure of the hydraulic hose must be equal to or higher than the relief valve setting on the hydraulic system. There are three types of hydraulic hose that meet this requirement and are authorized for use with Stanley Hydraulic Tools. They are:

Certified non-conductive — constructed of thermoplastic or synthetic rubber inner tube, synthetic fiber braid reinforcement, and weather resistant thermoplastic or synthetic rubber cover. *Hose labeled **certified non-conductive** is the only hose authorized for use near electrical conductors.*

Wire-braided (conductive) — constructed of synthetic rubber inner tube, single or double wire braid reinforcement, and weather resistant synthetic rubber cover. *This hose is **conductive** and must never be used near electrical conductors.*

Fabric-braided (not certified or labeled non-conductive) — constructed of thermoplastic or synthetic rubber inner tube, synthetic fiber braid reinforcement, and weather resistant thermoplastic or synthetic rubber cover. *This hose is **not certified non-conductive** and must never be used near electrical conductors.*

HOSE SAFETY TAGS

To help ensure your safety, the following DANGER tags are attached to all hose purchased from Stanley Hydraulic Tools. DO NOT REMOVE THESE TAGS.

If the information on a tag is illegible because of wear or damage, replace the tag immediately. A new tag may be obtained from your Stanley Distributor.

THE TAG SHOWN BELOW IS ATTACHED TO “CERTIFIED NON-CONDUCTIVE” HOSE

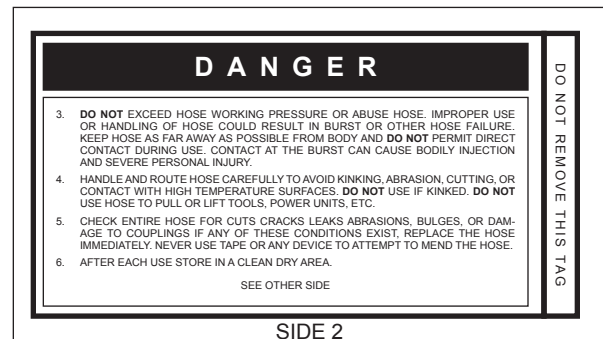
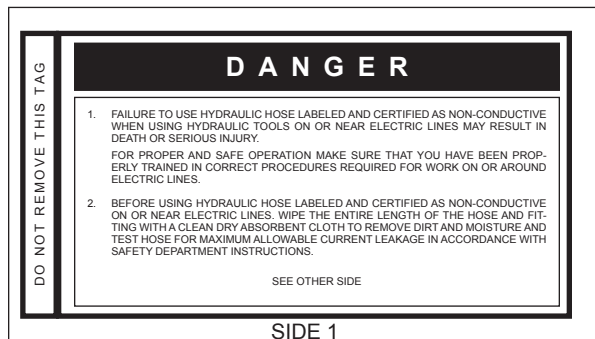

(Shown smaller than actual size)

THE TAG SHOWN BELOW IS ATTACHED TO “CONDUCTIVE” HOSE.

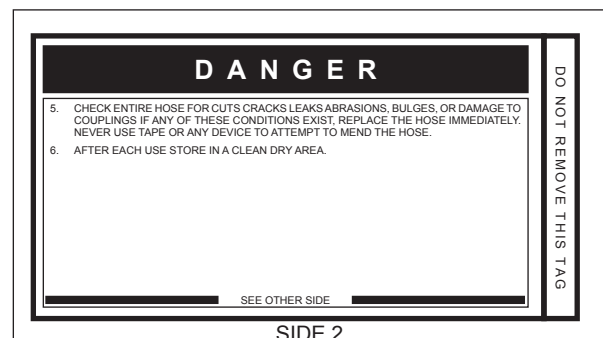
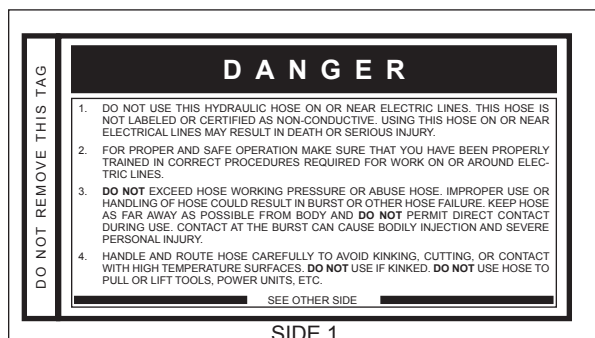

(Shown smaller than actual size)

HOSE RECOMMENDATIONS

Tool to Hydraulic Circuit Hose Recommendations

The chart to the right shows recommended minimum hose diameters for various hose lengths based on gallons per minute (gpm)/liters per minute (lpm). These recommendations are intended to keep return line pressure (back pressure) to a minimum acceptable level to ensure maximum tool performance.

This chart is intended to be used for hydraulic tool applications only based on Stanley Hydraulic Tools tool operating requirements and should not be used for any other applications.

All hydraulic hose must have at least a rated minimum working pressure equal to the maximum hydraulic system relief valve setting.

All hydraulic hose must meet or exceed specifications as set forth by SAE J517.

Oil Flow		Hose Lengths		Inside Diameter		USE (Press/Return)	Min. Working Pressure	
GPM	LPM	FEET	METERS	INCH	MM		PSI	BAR
Certified Non-Conductive Hose - Fiber Braid - for Utility Bucket Trucks								
4-9	15-34	up to 10	up to 3	3/8	10	Both	2250	155
Conductive Hose - Wire Braid or Fiber Braid -DO NOT USE NEAR ELECTRICAL CONDUCTORS								
4-6	15-23	up to 25	up to 7.5	3/8	10	Both	2500	175
4-6	15-23	26-100	7.5-30	1/2	13	Both	2500	175
5-10.5	19-40	up to 50	up to 15	1/2	13	Both	2500	175
5-10.5	19-40	51-100	15-30	5/8	16	Both	2500	175
5-10.5	19-40	100-300	30-90	5/8	16	Pressure	2500	175
10-13	38-49	up to 50	up to 15	3/4	19	Return	2500	175
10-13	38-49	51-100	15-30	5/8	16	Both	2500	175
10-13	38-49	100-200	30-60	3/4	19	Pressure	2500	175
13-16	49-60	up to 25	up to 8	5/8	16	Return	2500	175
13-16	49-60	26-100	8-30	3/4	19	Pressure	2500	175
				1	25.4	Return	2500	175
				5/8	16	Pressure	2500	175
				3/4	19	Return	2500	175
				3/4	19	Pressure	2500	175
				1	25.4	Return	2500	175

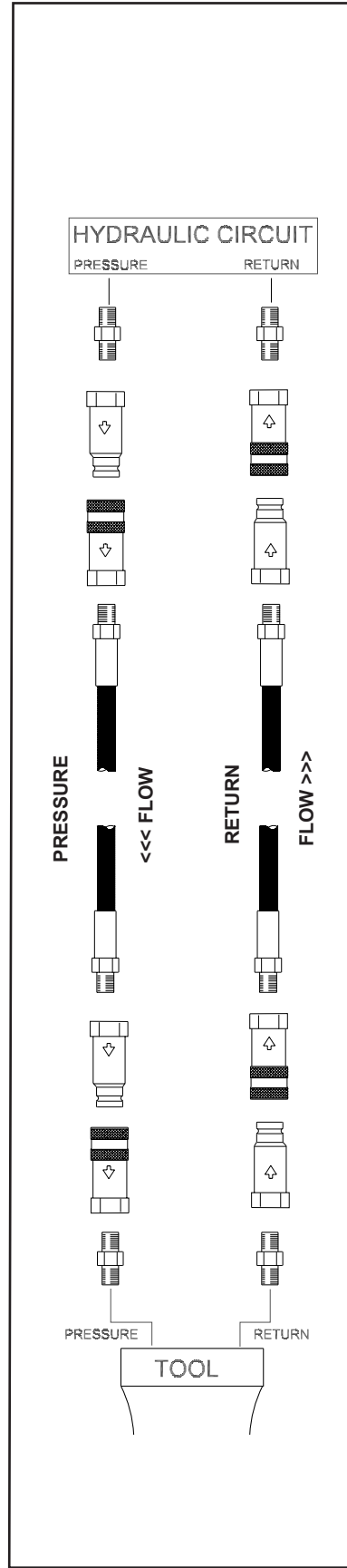

Figure 1. Typical Hose Connections

HTMA / EHTMA REQUIREMENTS

HTMA / EHTMA REQUIREMENTS

HTMA





HYDRAULIC SYSTEM REQUIREMENTS

TOOL TYPE

	TYPE I	TYPE II	TYPE RR	TYPE III
Flow Range	4-6 gpm (15-23 lpm)	7-9 gpm (26-34 lpm)	9-10.5 gpm (34-40 lpm)	11-13 gpm (42-49 lpm)
Nominal Operating Pressure (at the power supply outlet)	1500 psi (103 bar)	1500 psi (103 bar)	1500 psi (103 bar)	1500 psi (103 bar)
System relief valve setting (at the power supply outlet)	2100-2250 psi (145-155 bar)	2100-2250 psi (145-155 bar)	2200-2300 psi (152-159 bar)	2100-2250 psi (145-155 bar)
Maximum back pressure (at tool end of the return hose)	250 psi (17 bar)	250 psi (17 bar)	250 psi (17 bar)	250 psi (17 bar)
Measured at a max. fluid viscosity of: (at min. operating temperature)	400 ssu* (82 centistokes)	400 ssu* (82 centistokes)	400 ssu* (82 centistokes)	400 ssu* (82 centistokes)
Temperature: Sufficient heat rejection capacity to limit max. fluid temperature to: (at max. expected ambient temperature)	140° F (60° C)	140° F (60° C)	140° F (60° C)	140° F (60° C)
Min. cooling capacity at a temperature difference of between ambient and fluid temps	3 hp (2.24 kW) 40° F (22° C)	5 hp (3.73 kW) 40° F (22° C)	6 hp (5.22 kW) 40° F (22° C)	7 hp (4.47 kW) 40° F (22° C)
NOTE: Do not operate the tool at oil temperatures above 140° F (60° C). Operation at higher temperatures can cause operator discomfort at the tool.				
Filter Min. full-flow filtration Sized for flow of at least: (For cold temp. startup and max. dirt-holding capacity)	25 microns 30 gpm (114 lpm)	25 microns 30 gpm (114 lpm)	25 microns 30 gpm (114 lpm)	25 microns 30 gpm (114 lpm)
Hydraulic fluid Petroleum based (premium grade, anti-wear, non-conductive) Viscosity (at min. and max. operating temps)	100-400 ssu*	100-400 ssu* (20-82 centistokes)	100-400 ssu*	100-400 ssu*
NOTE: When choosing hydraulic fluid, the expected oil temperature extremes that will be experienced in service determine the most suitable temperature viscosity characteristics. Hydraulic fluids with a viscosity index over 140 will meet the requirements over a wide range of operating temperatures.				
*SSU = Saybolt Seconds Universal				

EHTMA HYDRAULIC SYSTEM REQUIREMENTS

CLASSIFICATION

					
Flow Range	3.5-4.3 gpm (13.5-16.5 lpm)	4.7-5.8 gpm (18-22 lpm)	7.1-8.7 gpm (27-33 lpm)	9.5-11.6 gpm (36-44 lpm)	11.8-14.5 gpm (45-55 lpm)
Nominal Operating Pressure (at the power supply outlet)	1870 psi (129 bar)	1500 psi (103 bar)	1500 psi (103 bar)	1500 psi (103 bar)	1500 psi (103 bar)
System relief valve setting (at the power supply outlet)	2495 psi (172 bar)	2000 psi (138 bar)	2000 psi (138 bar)	2000 psi (138 bar)	2000 psi (138 bar)

NOTE: These are general hydraulic system requirements. See tool specification page for tool specific requirements

OPERATION

PRE-OPERATION PROCEDURES

CHECK HYDRAULIC POWER SOURCE

1. Using a calibrated flowmeter and pressure gauge, check that the hydraulic power source develops a flow of 9–10.5 gpm/34–40 lpm at 2000 psi/140 bar.
2. Make certain the hydraulic power source is equipped with a relief valve set to open at 2200–2300 psi/152–159 bar minimum.
3. Check that the hydraulic circuit matches the tool for open-center (OC) operation.

CHECK TOOL

1. Make sure all tool accessories are correctly installed. Failure to install tool accessories properly can result in damage to the tool or personal injury.
2. There should be no signs of leaks.
3. The tool should be clean, with all fittings and fasteners tight.

CHECK TRIGGER MECHANISM

1. Check that the trigger operates smoothly and is free to travel between the **ON** and **OFF** positions.

CHECK GUARD ASSEMBLY

1. Inspect the wheel guard assembly for cracks and other structural damage.

INSTALLING AND REMOVING ABRASIVE CUTTING WHEELS

NOTE:

Use 14 in./350 mm diameter (for 14 in. model) or 16 in./400 mm diameter (for 16 in. model) abrasive cutting wheels with a 1 in. arbor hole. Only use cutting wheels which comply with ANSI B7.5/ISO 525, 603. Make sure the paper labels or blotters are installed between the wheel and collars.

1. Before installing abrasive wheels, “sound” the wheel for possible damage by hanging the wheel vertically by the arbor hole and rapping lightly with a screwdriver handle or similar instrument. Thin, organic bond wheels will produce a low drumming tone if it is physically sound. If the wheel produces a “dead” or “flat” sound, it may be cracked. Cracked or damaged wheels must never be used.

2. Check that the surfaces of the wheel that come in contact with blotters and flanges are free of dirt and other foreign particles.
3. Remove the jam nut (77) and outside collar (78) by using a box type wrench while gripping the cutting wheel.
4. Install the cutting wheel. Make sure blotters or labels remain on the cutting wheel.
5. Reinstall the outside collar and jam nut. Tighten the jam nut with a box type wrench while gripping the cutting wheel. Only tighten sufficiently to prevent slippage of the wheel between the collars (78 & 79).

DRIVE SHAFT SPEED CHECK

The speed of the motor output shaft should be checked at least every 100 hours of operation by trained and experienced personnel. A record of the speed checks should be maintained. The rated speed of the RS25 Rail Saw is 3600 rpm at 10 gpm/38 lpm for the 16 inch/400 mm model and 4500 rpm at 10 gpm/38 lpm for the 14 inch/350 mm model. The cutting wheel must be rated for a minimum of 4700 rpm for the 16 inch/400 mm model and 5300 rpm for the 14 inch/350 mm model. Tests should be conducted while operating the normal power supply used with the saw.

CONNECT HOSES

1. Wipe all hose couplers with a clean lint-free cloth before making connections.
2. Connect the hoses from the hydraulic power source to the hose couplers on the rail saw. It is a good practice to connect the return hose first and disconnect it last to minimize or avoid trapped pressure within the rail saw motor.
3. Observe flow indicators stamped on hose couplers to be sure that oil will flow in the proper direction. The female coupler is the inlet coupler.

NOTE:

The pressure increase in uncoupled hoses left in the sun may result in making them difficult to connect. When possible, connect the free ends of operating hoses together.

OPERATION

OPERATING PROCEDURES

CLAMPING THE RAIL SAW TO THE RAIL

1. Observe all safety precautions.
2. Make sure the rail clamp assembly is tight to the disconnect pivot (60) by turning the handle (20) to tighten the disconnect pivot bolt.
3. Fully extend the indicator rod located on the clamp and position the rail clamp on the rail so the clamp arms bear on the top and sides of the rail and the bell crank bears under the rail as shown in Figure 2.

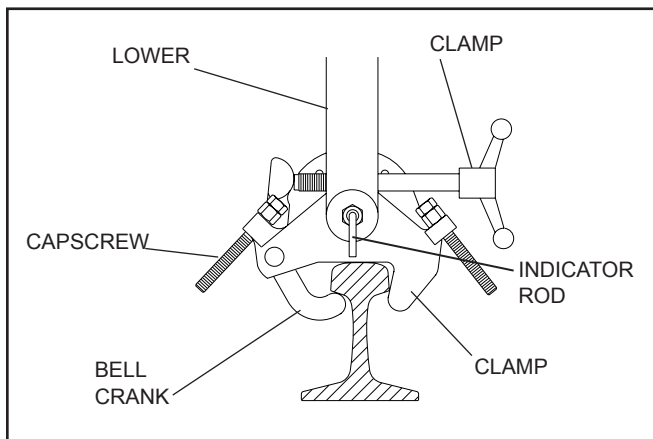

Figure 2.

4. Move the rail saw along the rail until the indicator is next to the cut as shown in Figure 3.

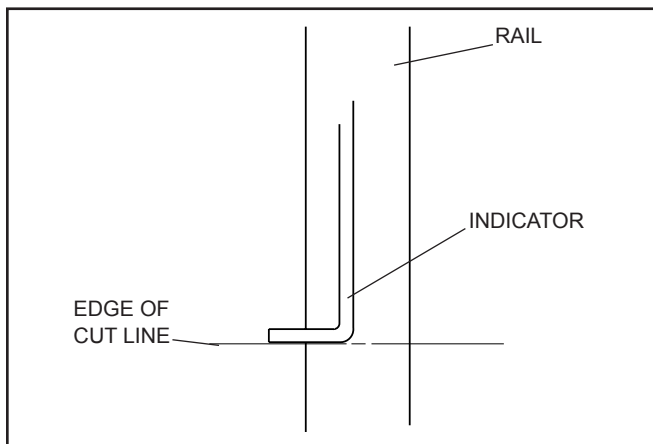

Figure 3.

5. Tighten the bell crank to the rail by turning the clamp screw (75) clockwise.

6. While holding onto the upper link of the rail clamp assembly (near the red knob of the handle), release the detent (129) by turning the knob and then position the lower link forward (*away from the operator*) until the detent can be re-engaged in one or the other of the two holes away from the "top dead center hole". This positions the saw so that the operator may stand erect while cutting the rail and also allows the saw to cut down to the flange of the rail.

An optional method is to disengage the detent and adjust the capscrews (see Figure 2) as required.

7. Adjust the wheel guard (87) so that it does not interfere with the cutting process and cuttings are directed away from the operator.

SAWING THE RAIL

1. Always start the rail saw with the cutting wheel away from the work surface.
2. Start the cut with the wheel rotating.

NOTE:

Do not "bump" the rail. Feed the wheel through the material as fast as possible without allowing the wheel to reduce its speed. Cutting through the material too slowly allows heat expansion and can cause wheel "pinching" in the material. "Pinching" the wheel from heat expansion is one of the most common causes of wheel breakage.

3. Starting at the top of the rail, cut straight down while rocking the handle back and forth. Cut down until near the flange.
4. When near the flange, stop the saw, release the detent and move the lower link toward the operator until the detent can be re-engaged in one of the holes away from the "top dead center hole". This positions the saw lower so that the flange of the rail may be easily cut.

If the detent has been removed in favor of using the capscrews as stops for the lower link, simply move the lower link toward the cap screw closest to the operator.

If the wheel is worn such that it will not completely cut through the rail, loosen the clamp lever on the saw, and rotate the saw to allow cutting from the opposite side. Readjust the lower link as required and finish the cut.

OPERATION

DETACHING THE UPPER AND LOWER LINKS

The upper and lower links of the rail clamp assembly can be detached from the motor mount (50) by unscrewing the handle (20).

SAW STORAGE

By disengaging the double cam (52), the rail clamp assembly can be rotated so that the entire saw has a flatter profile for storage.

Do not store the saw with the abrasive wheel attached.

CARE OF ABRASIVE CUT-OFF WHEELS

CAUTION

All abrasive cut-off wheels are breakable and, therefore, care must be exercised during handling and storage to prevent damage.

Wheels should be laid on a flat, rigid, surface away from excessive heat or moisture. Wheels should not be stored where they will be exposed to high humidity, water, other liquids or freezing temperature. If wheels are supplied with blotters attached, suitable separators should be used to preserve flatness.

COLD WEATHER OPERATION

If the saw is to be used during cold weather, preheat the hydraulic fluid at low engine speed. When using the normally recommended fluids, fluid temperature should be at or above 50 °F/10 °C (400 ssu/82 centistokes) before use.

INVESTIGATION OF WHEEL BREAKAGE

If a wheel breaks during use, a careful investigation should be conducted by to determine the cause of the breakage. The cause must then be corrected before using the saw again.

If unable to determine the cause of breakage, the wheel manufacturer should be consulted.

TOOL PROTECTION & CARE

NOTICE

In addition to the Safety Precautions found in this manual, observe the following for equipment protection and care.

- Make sure all couplers are wiped clean before connection.
- The hydraulic circuit control valve must be in the **OFF** position when coupling or uncoupling hydraulic tools. Failure to do so may result in damage to the quick couplers and cause overheating of the hydraulic system.
- Always store the tool in a clean dry space, safe from damage or pilferage.
- Make sure the circuit **PRESSURE** hose (with male quick disconnect) is connected to the **IN** port. The circuit **RETURN** hose (with female quick disconnect) is connected to the opposite port. Do not reverse circuit flow. This can cause damage to internal seals.
- Always replace hoses, couplings and other parts with replacement parts recommended by Stanley Hydraulic Tools. Supply hoses must have a minimum working pressure rating of 2500 psi/172 bar.
- Do not exceed the rated flow (see Specifications) in this manual for correct flow rate and model number. Rapid failure of the internal seals may result.
- Always keep critical tool markings, such as warning stickers and tags legible.
- Tool repair should be performed by experienced personnel only.
- Make certain that the recommended relief valves are installed in the pressure side of the system.
- Do not use the tool for applications for which it was not intended.

TROUBLESHOOTING

If symptoms of poor performance develop, the following chart can be used as a guide to correct the problem.

When diagnosing faults in operation of the grinder, always check that the hydraulic power source is supplying the correct hydraulic flow and pressure to the grinder as listed in the table. Use a flowmeter known to be accurate. Check the flow with the hydraulic oil temperature at least 80 °F/27 °C.

SYMPTOM	POSSIBLE CAUSE	SOLUTION
Saw does not run.	Hydraulic power source not functioning correctly.	Check power source for proper flow and pressure (7–10 gpm/26–34 lpm, 2000 psi/140 bar).
	Coupler or hoses blocked.	Remove obstruction.
	Mechanical failure.	Have tool serviced by authorized dealer.
Saw runs backwards.	Pressure and return lines incorrectly connected.	Correct hose connections. Motor shaft rotates counter-clockwise as viewed from the end of the motor shaft.
Saw cuts too slow.	Insufficient fluid flow or too high back-pressure or relief valve set too low.	Check hydraulic supply. If hydraulic supply is correct, have unit serviced by authorized dealer.
	Wrong wheel for material being cut.	Use correct wheel.
Fluid leakage.	Seal failure.	Do not use. Have serviced by an authorized dealer.
Off-center cut and binding.	Bearings worn on link arms.	Have unit serviced by an authorized dealer.
	Incorrect cutting technique.	Review operating procedures.

SPECIFICATIONS

Wheel Capacity	
14 inch Model.....	14 in./35.5 cm Dia. × 25.4 mm Arbor (ANSI B7.5/ISO 525, 603)
16 inch Model.....	16 in./41 cm Dia. × 1 in. Arbor (ANSI B7.5/ISO 525, 603)
Pressure Range.....	1800–2000 psi/124–140 bar
Maximum Back Pressure.....	250 psi/17 bar
Flow Range.....	HTMA Class RR, 9–10.5 gpm/34–40 lpm
EHTMA (D).....	30 lpm – 138 bar
EHTMA (E).....	40 lpm – 138 bar
Porting.....	-8 SAE O-ring
Couplers.....	HTMA/EHTMA Flush Face Type
Hose Whips.....	Yes
Weight (with hose whips & couplers).....	14.1 lb/6.40 kg
Overall Length.....	36 inches/92 cm
Overall Width.....	11 inches/28 cm
Overall Height (w/wheel, guard rotated to any position).....	13 inches/33 cm
Weight (less wheel)	
14 inch Model.....	55 lbs/24.4 kg
16 inch Model.....	56 lbs/25 kg
RPM	
14 inch Model.....	4500
16 inch Model.....	4000
Maximum Fluid Temperature.....	140 °F/60 °C
Rail Size.....	75–165 lb/yard/37–82 kg/M

Sound and Vibration Declaration	
Test conducted on RS25103, operated at standard 10 gpm input	
Measured A-weighted sound power level, Lwa (ref. 1pW) in decibels	108 dBA
Uncertainty, Kwa, in decibels	3 dBA
Measured A-weighted sound pressure level, Lpa (ref. 20 µPa) at operator's position, in decibels	97 dBA
Uncertainty, Kpa, in decibels	3 dBA
Values determined according to noise test code given in ISO 15744, using the basic standard ISO 3744	
NOTE: The sum of a measured noise emission value and its associated uncertainty represents an upper boundary of the range of values which is likely to occur in measurements.	
Declared vibration emission value in accordance with EN 12096	
Measured vibration emission value: a	9.1 m/sec ²
Uncertainty: K	2.4 m/sec ²
Values determined according to ISO 8662-1, ISO 5349-1,2	

ACCESSORIES

Railsaw Blade 14 inch Custom-Labeled.....	73647
Railsaw Blade 16 inch Custom-Labeled.....	73648
Railsaw Blade 16 inch Norton AT-36.....	22439
Railsaw Blade 16 inch Norton Norzone III Fastcut.....	29745
Railsaw Blade 14 inch Norton Norzone III Fastcut.....	30974
Seal Kit (Includes 66399 JIHOSTROJ Seal Kit).....	31845
Motor Seal Kit Assy (Serial No. 3585 (included in 31845)).....	66399
Universal Bellcrank Kit (Grooved Rail).....	34733
Motor Upgrade Kit 14 inch Model (After Serial No. 2598).....	66191
Includes 65625 Disconnect Pivot Bolt, 65626 Pivot Tube, 65627 Indicator Rod, 66133 Motor Assy)	
Motor Upgrade Kit 16 inch Model (After Serial No. 2598).....	66192
Includes 65625 Disconnect Pivot Bolt, 65626 Pivot Tube, 65627 Indicator Rod, 66134 Motor Assy)	

RS25 PARTS ILLUSTRATION

RS25 RAIL SAW - 14" & 16"

March 2011

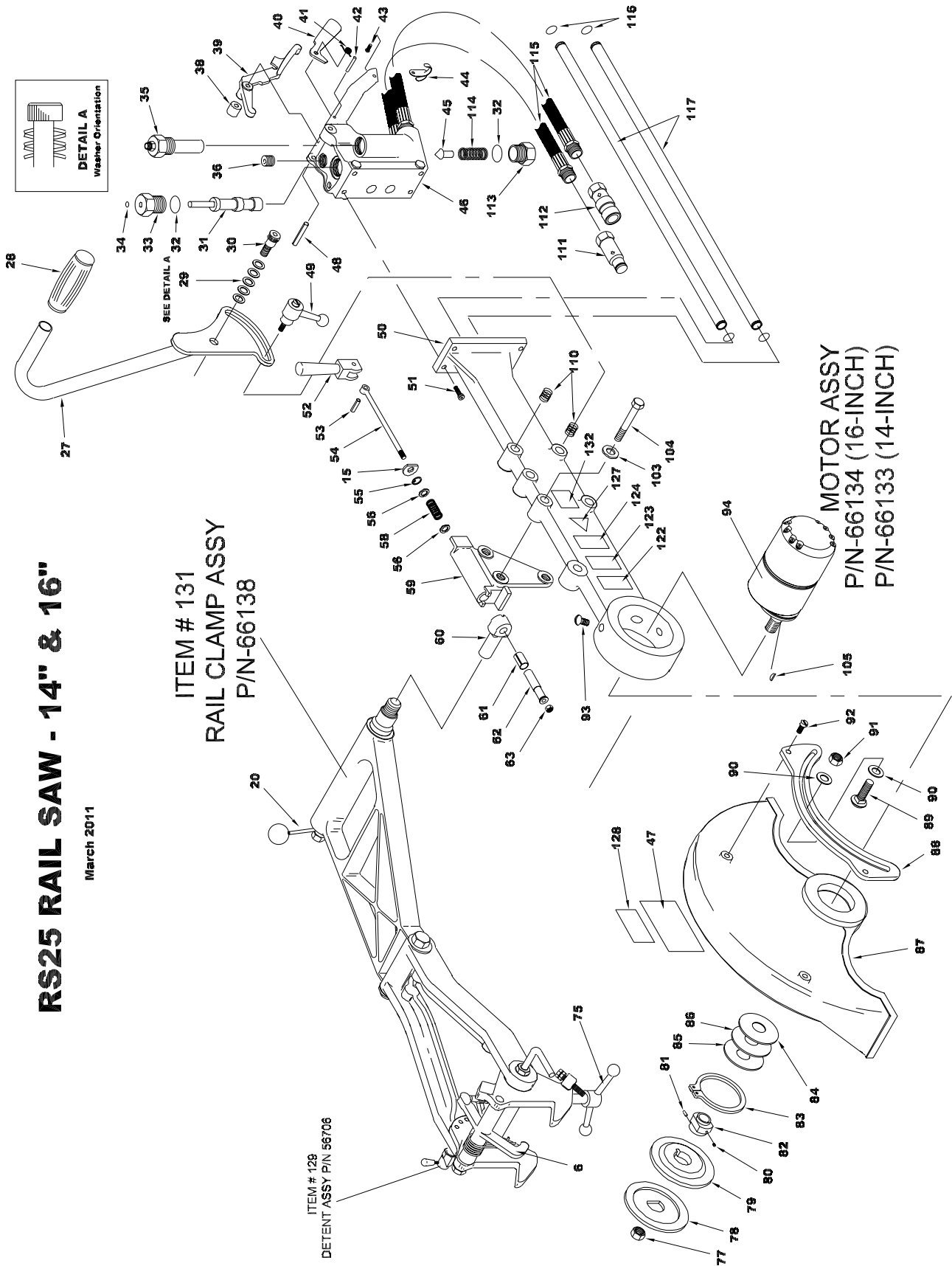

RS25 PARTS LIST

ITEM	PART NO.	QTY	DESCRIPTION
6	28181	1	BELL CRANK
15	30958	1	"D" WASHER
20	66136	1	HANDLE WELDMENT
26	—	1	*REFER TO ITEM 131
27	30671	1	ASSIST HANDLE
28	31030	1	HANDLE GRIP
29	31181	5	BELLEVILLE WASHER
30	30667	1	SHOULDER BOLT
31	31138	1	VALVE SPOOL
32	01604	2	O-RING*
33	02931	1	VALVE CAP
34	00112	1	QUAD RING*
35	31853	1	FLOW CONTROL (16 IN MODEL ONLY)
	31854	1	FLOW CONTROL (14 IN MODEL ONLY)
36	08104	1	SAE PLUG
38	02920	1	SPACER
39	22707	1	TRIGGER
40	22704	1	SAFETY CATCH
41	22701	1	TORSION SPRING
42	03009	1	ROLL PIN
43	00165	1	SCREW
44	02911	1	HOSE CLIP
45	31186	1	POPPET
46	28552	1	VALVE HANDLE ASSY (INCL ITEM 36)
47	17641	1	WHEEL SAFETY LABEL (16 IN MODEL)
	05868		WHEEL SAFETY LABEL (14 IN MODEL)
48	17681	1	ROLL PIN
49	24869	1	HANDLE
50	35289	1	MOTOR MOUNT ASSY
51	02688	4	CAPSCREW
52	30632	1	DOUBLE CAM
53	30635	1	SPIROL PIN
54	29510	1	EYE BOLT
55	04856	1	RETAINING RING
56	30841	2	WASHER
58	28673	1	SPRING
59	30412	1	MOTOR MOUNT PIVOT
60	30530	1	DISCONNECT PIVOT
61	28711	1	TOLERANCE RING
62	30543	1	STUD
63	04353	1	LOCKNUT
75	56708	1	CLAMP SCREW ASSY
77	03012	1	JAM NUT
78	62291	1	OUTER COLLAR

ITEM	PART NO.	QTY	DESCRIPTION
79	62290	1	INSIDE COLLAR
80	00720	1	SET SCREW
81	23246	1	DOWEL PIN
82	59050	1	THRUST COLLAR
83	30219	1	RETAINING RING
84	31034	A/R	SHIM, .005
85	31032	A/R	SHIM, .020
86	31033	A/R	SHIM, .010
87	30957	1	WHEEL GUARD (16 IN MODEL)
	28709	1	WHEEL GUARD (14 IN MODEL)
	73168		WHEEL GUARD (16 IN MODEL) LOW SPARK (SEE PHOTO PAGE 19)
88	17652	1	SECTOR
89	28729	1	CARRIAGE BOLT
90	01594	2	WASHER
91	03906	1	LOCKNUT
92	17676	2	CAPSCREW
93	03006	2	MACHINE SCREW
94	66134	1	MOTOR ASSY (16 IN, CAN ONLY BE PURCHASED AS AN ASSEMBLY)
	66133	1	MOTOR ASSY (14 IN, CAN ONLY BE PURCHASED AS AN ASSEMBLY)
103	00283	3	LOCK WASHER
104	16260	3	CAPSCREW
105	00772	1	KEY
110	00698	2	HELICOIL
111	03973	1	MALE COUPLER BODY (PARKER)
	47437	1	MALE COUPLER BODY (AEROQUIP)
112	03972	1	FEMALE COUPLER BODY (PARKER)
	47436	1	FEMALE COUPLER BODY (AEROQUIP)
113	31137	1	PLUG
114	02916	1	SPRING
115	56725	2	HOSE ASSY (PARKER)
	66727	1	HOSE ASSY (AEROQUIP)
116	00175	4	O-RING*
117	29604	2	OIL TUBE
118	30922	1	O-RING (16 IN MODEL)*
	350771	1	O-RING (14 IN MODEL)*
119	30921	1	QUAD RING (16 IN MODEL)*
	00214	1	QUAD RING (14 IN MODEL)*
122	28728	1	NAME TAG (16 IN MODEL)
	28409	1	COMPOSITE STICKER (14 IN MODEL)
123	25610	1	RAILROAD HELP DESK (16 IN MODEL)
	28728	1	NAME TAG (14 IN MODEL)
124	03787	1	GPM STICKER (16 IN MODEL)

RS25 PARTS LIST

Verify the correct model number before ordering.

ITEM	PART NO.	QTY	DESCRIPTION
	28322	1	CE STICKER (14 IN MODEL)
127	11207	1	CIRCUIT "D" STICKER (14 IN MODEL)
128	28811	1	INFORMATION PLAQUE (14 IN MODEL)
129	56706	1	DETENT ASSY
130	—	1	REFER TO ITEM 129
131	66138	1	RAIL CLAMP ASSY
132	11210	1	SOUND POWER STICKER
133	05152	1	LOGO-ADDRESS DECAL
	66134	1	MOTOR ASSY
	31845	1	SEAL KIT

* DENOTES PART IN SEAL KIT

Item 133 (P/N-05152)
Logo/Address Decal (UP Model Only)

WHEEL GUARD 16 INCH
"LOW SPARK" P/N-73168

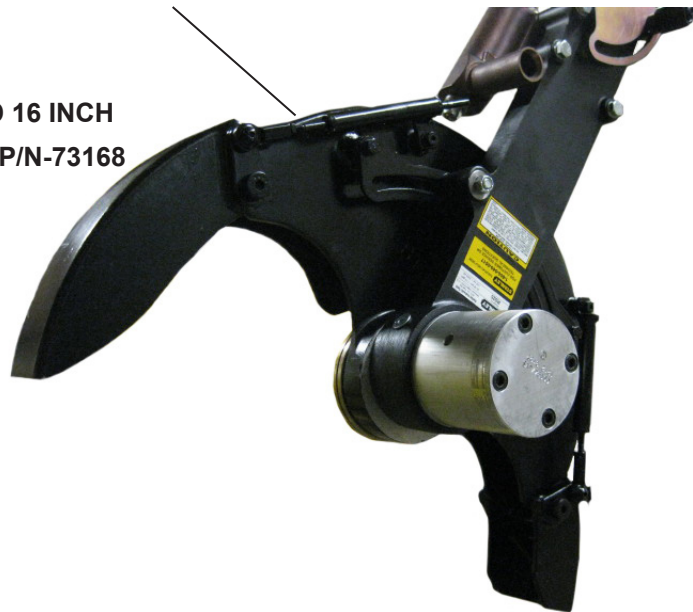

STANLEY®

Stanley Hydraulic Tools
3810 SE Naef Road
Milwaukie, Oregon 97267-5698 USA
(503) 659-5660 / Fax (503) 652-1780
www.stanleyhydraulics.com

Free Manuals Download Website

<http://myh66.com>

<http://usermanuals.us>

<http://www.somanuals.com>

<http://www.4manuals.cc>

<http://www.manual-lib.com>

<http://www.404manual.com>

<http://www.luxmanual.com>

<http://aubethermostatmanual.com>

Golf course search by state

<http://golfingnear.com>

Email search by domain

<http://emailbydomain.com>

Auto manuals search

<http://auto.somanuals.com>

TV manuals search

<http://tv.somanuals.com>