

STANLEY®

TP03 HYDRAULIC TRASH PUMP



USER MANUAL Safety, Operation and Maintenance



© 2012 Stanley Black & Decker, Inc.
New Britain, CT 06053
U.S.A.
58555 7/2014 Ver.12

DECLARATION OF CONFORMITY

DECLARATION OF CONFORMITY
 ÜBEREINSTIMMUNGS-ERKLÄRUNG
 DECLARATION DE CONFORMITE CEE
 DECLARACION DE CONFORMIDAD
 DICHIARAZIONE DI CONFORMITA



I, the undersigned:
 Ich, der Unterzeichnende:
 Je soussigné:
 El abajo firmante:
 Io sottoscritto:

Weisbeck, Andy

Surname and First names/Familiennamen und Vornamen/Nom et prénom/Nombre y apellido/Cognome e nome

hereby declare that the equipment specified hereunder:
 bestätige hiermit, daß erklaren Produkt genannten Werk oder Gerät:
 déclare que l'équipement visé ci-dessous:
 Por la presente declaro que el equipo se especifica a continuación:
 Dichiaro che le apparecchiature specificate di seguito:

- Category: **Trash Pump, Hydraulic**
 Kategorie:
 Catégorie:
 Categoria:
 Categoria:
- Make/Marke/Marque/Marca/Marca **Stanley**
- Type/Typ/Type/Tipo/Tipo: **TP0300301, TP0300301D, TP0300303**
- Serial number of equipment:
 Seriennummer des Geräts:
 Numéro de série de l'équipement:
 Numero de serie del equipo:
 Matricola dell'attrezzatura: **All**

Has been manufactured in conformity with
 Wurde hergestellt in Übereinstimmung mit
 Est fabriqué conformément
 Ha sido fabricado de acuerdo con
 E' stata costruita in conformità con

Directive/Standards Richtlinie/Standards Directives/Normes Directriz/Los Normas Direttiva/Norme	No. Nr Numéro No n.	Approved body Prüfung durch Organisme agréé Aprobado Collaudato
EN Machinery Directive EN ISO	809:2009 2006/42/EC:2006 3744:2009	Self Self Self

- Special Provisions: **None**
 Spezielle Bestimmungen:
 Dispositions particulières:
 Provisiones especiales:
 Disposizioni speciali:
- Representative in the Union: **Patrick Vervier, Stanley Dubuis 17-19, rue Jules Berthonneau-BP 3406 41034 Blois Cedex, France.**
 Vertreter in der Union/Représentant dans l'union/Representante en la Union/Rappresentante presso l'Unione

Done at/Ort/Fait à/Dado en/Fatto a Stanley Hydraulic Tools, Milwaukie, Oregon USA Date/Datum/le/Fecha/Data 1-5-11

Signature/Unterschrift/Signature/Firma/Firma 
 Position/Position/Fonction/Cargo/Posizione Engineering Manager

1/5/2011

TABLE OF CONTENTS

DECLARATION OF CONFORMITY	2
SAFETY SYMBOLS	4
SAFETY PRECAUTIONS.....	5
TOOL STICKERS & TAGS	6
HOSE TYPES.....	7
HOSE RECOMMENDATIONS	8
FIGURE 1. TYPICAL HOSE CONNECTIONS	8
HTMA REQUIREMENTS.....	9
OPERATION.....	10
TOOL PROTECTION & CARE	12
TROUBLESHOOTING	13
SPECIFICATIONS.....	14
ACCESSORIES.....	14
TP03 PARTS ILLUSTRATION.....	15
TP03 PARTS LIST.....	16
UNDERWATER TOOLS DEPTH GUIDELINE.....	17

IMPORTANT

To fill out a Product Warranty Recording form, and for information on your warranty, visit Stanleyhydraulics.com and select the Company tab, Warranty.
(NOTE: The warranty recording form must be submitted to validate the warranty).

SERVICING THE STANLEY HYDRAULIC PUMP. This manual contains safety, operation, and routine maintenance instructions. Stanley Hydraulic Tools recommends that servicing of hydraulic tools, other than routine maintenance, must be performed by an authorized and certified dealer. Please read the following warning.

⚠ WARNING

SERIOUS INJURY OR DEATH COULD RESULT FROM THE IMPROPER REPAIR OR SERVICE OF THIS TOOL.

REPAIRS AND / OR SERVICE TO THIS TOOL MUST ONLY BE DONE BY AN AUTHORIZED AND CERTIFIED DEALER.

For the nearest authorized and certified dealer, call Stanley Hydraulic Tools at the number listed on the back of this manual and ask for a Customer Service Representative.

SAFETY SYMBOLS

Safety symbols and signal words, as shown below, are used to emphasize all operator, maintenance and repair actions which, if not strictly followed, could result in a life-threatening situation, bodily injury or damage to equipment.



This is the safety alert symbol. It is used to alert you to potential personal injury hazards. Obey all safety messages that follow this symbol to avoid possible injury or death.



This safety alert and signal word indicate an imminently hazardous situation which, if not avoided, will result in death or serious injury.



This safety alert and signal word indicate a potentially hazardous situation which, if not avoided, could result in death or serious injury.



This safety alert and signal word indicate a potentially hazardous situation which, if not avoided, could result in death or serious injury.



This signal word indicates a potentially hazardous situation which, if not avoided, may result in property damage.



This signal word indicates a situation which, if not avoided, will result in damage to the equipment.



This signal word indicates a situation which, if not avoided, may result in damage to the equipment.

Always observe safety symbols. They are included for your safety and for the protection of the tool.

LOCAL SAFETY REGULATIONS

Enter any local safety regulations here. Keep these instructions in an area accessible to the operator and maintenance personnel.

SAFETY PRECAUTIONS

Tool operators and maintenance personnel must always comply with the safety precautions given in this manual and on the stickers and tags attached to the tool and hose.

These safety precautions are given for your safety. Review them carefully before operating the tool and before performing general maintenance or repairs.

Supervising personnel should develop additional precautions relating to the specific work area and local safety regulations. If so, place the added precautions in the space provided in this manual.

The models TP03 Hydraulic Trash Pump will provide safe and dependable service if operated in accordance with the instructions given in this manual. Read and understand this manual and any stickers and tags attached to the tool and hoses before operation. Failure to do so could result in personal injury or equipment damage.



- Operator must start in a work area without bystanders. The operator must be familiar with all prohibited work areas such as excessive slopes and dangerous terrain conditions.
- Establish a training program for all operators to ensure safe operations.
- Do not operate the tool unless thoroughly trained or under the supervision of an instructor.
- Always wear safety equipment such as goggles, head protection, and safety shoes at all times when operating the tool.
- Do not inspect or clean the tool while the hydraulic power source is connected. Accidental engagement of the tool can cause serious injury.
- Do not operate this tool without first reading the Operation section.
- Do not install or remove this tool while the hydraulic power source is connected. Accidental engagement of the tool can cause serious injury.
- Never operate the tool near energized transmission lines. Know the location of buried or covered services before starting work.
- Do not wear loose fitting clothing when operating the tool. Loose fitting clothing can get entangled with the tool and cause serious injury.
- Supply hoses must have a minimum working pressure rating of 2500 psi/175 bar.
- Be sure all hose connections are tight.
- The hydraulic circuit control valve must be in the "OFF" position when coupling or uncoupling the tool. Wipe all couplers clean before connecting. Failure to do so may result in damage to the quick couplers and cause overheating. Use only lint-free cloths.
- Do not operate the tool at oil temperatures above 140 °F/60 °C. Operation at higher oil temperatures can cause operator discomfort and may cause damage to the tool.
- Do not operate a damaged, improperly adjusted, or incompletely assembled tool.
- To avoid personal injury or equipment damage, all tool repair, maintenance and service must only be performed by authorized and properly trained personnel.
- Do not exceed the rated limits of the tool or use the tool for applications beyond its design capacity.
- Always keep critical tool markings, such as labels and warning stickers legible.
- Always replace parts with replacement parts recommended by Stanley Hydraulic Tools.
- Check fastener tightness often and before each use daily.
- Do not put your hands or any other body part under the volute while the trash pump is running.
- Do not lift the trash pump by pulling on the hydraulic hoses. Use a suitable line fastened to the trash pump handle.
- Do not point water discharge toward bystanders.

TOOL STICKERS & TAGS

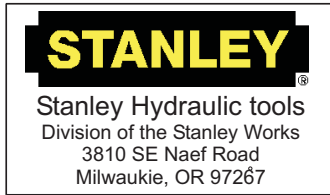

05152
Stanley Logo Decal



11207
Circuit Type D Decal
(CE Only)



03786
GPM Decal

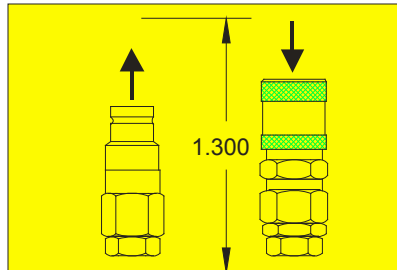

28786
Coupler Decal



28788
Manual Decal
(CE Only)



28322
CE Decal (CE Only)

NOTE:
THE INFORMATION LISTED ON THE STICKERS SHOWN, MUST BE LEGIBLE AT ALL TIMES.
REPLACE DECALS IF THEY BECOME WORN OR DAMAGED. REPLACEMENTS ARE AVAILABLE FROM YOUR LOCAL STANLEY DISTRIBUTOR.

The safety tag (P/N 15875) at right is attached to the tool when shipped from the factory. Read and understand the safety instructions listed on this tag before removal. We suggest you retain this tag and attach it to the tool when not in use.

DANGER

1. FAILURE TO USE HYDRAULIC HOSE LABELED AND CERTIFIED AS NON-CONDUCTIVE WHEN USING HYDRAULIC TOOLS ON OR NEAR ELECTRICAL LINES MAY RESULT IN DEATH OR SERIOUS INJURY.
BEFORE USING HOSE LABELED AND CERTIFIED AS NON-CONDUCTIVE ON OR NEAR ELECTRICAL LINES BE SURE THE HOSE IS MAINTAINED AS NON-CONDUCTIVE. THE HOSE SHOULD BE REGULARLY TESTED FOR ELECTRIC CURRENT LEAKAGE IN ACCORDANCE WITH YOUR SAFETY DEPARTMENT INSTRUCTIONS.
2. A HYDRAULIC LEAK OR BURST MAY CAUSE OIL INJECTION INTO THE BODY OR CAUSE OTHER SEVERE PERSONAL INJURY.
 - A. **DO NOT EXCEED SPECIFIED FLOW AND PRESSURE FOR THIS TOOL.** EXCESS FLOW OR PRESSURE MAY CAUSE A LEAK OR BURST.
 - B. **DO NOT EXCEED RATED WORKING PRESSURE OF HYDRAULIC HOSE USED WITH THIS TOOL.** EXCESS PRESSURE MAY CAUSE A LEAK OR BURST.
 - C. **CHECK TOOL HOSE COUPLERS AND CONNECTORS DAILY FOR LEAKS. DO NOT FEEL FOR LEAKS WITH YOUR HANDS. CONTACT WITH A LEAK MAY RESULT IN SEVERE PERSONAL INJURY.**

IMPORTANT

READ OPERATION MANUAL AND SAFETY INSTRUCTIONS FOR THIS TOOL BEFORE USING IT.

USE ONLY PARTS AND REPAIR PROCEDURES APPROVED BY STANLEY AND DESCRIBED IN THE OPERATION MANUAL.

TAG TO BE REMOVED ONLY BY TOOL OPERATOR.

SEE OTHER SIDE

DANGER

- D. **DO NOT LIFT OR CARRY TOOL BY THE HOSES. DO NOT ABUSE HOSE. DO NOT USE KINKED, TORN OR DAMAGED HOSE.**
3. **MAKE SURE HYDRAULIC HOSES ARE PROPERLY CONNECTED TO THE TOOL BEFORE PRESSURING SYSTEM. SYSTEM PRESSURE HOSE MUST ALWAYS BE CONNECTED TO TOOL "IN" PORT. SYSTEM RETURN HOSE MUST ALWAYS BE CONNECTED TO TOOL "OUT" PORT. REVERSING CONNECTIONS MAY CAUSE REVERSE TOOL OPERATION WHICH CAN RESULT IN SEVERE PERSONAL INJURY.**
4. **DO NOT CONNECT OPEN-CENTER TOOLS TO CLOSED-CENTER HYDRAULIC SYSTEMS. THIS MAY RESULT IN LOSS OF OTHER HYDRAULIC FUNCTIONS POWERED BY THE SAME SYSTEM AND/OR SEVERE PERSONAL INJURY.**
5. **BYSTANDERS MAY BE INJURED IN YOUR WORK AREA. KEEP BYSTANDERS CLEAR OF YOUR WORK AREA.**
6. **WEAR HEARING, EYE, FOOT, HAND AND HEAD PROTECTION.**
7. **TO AVOID PERSONAL INJURY OR EQUIPMENT DAMAGE, ALL TOOL REPAIR MAINTENANCE AND SERVICE MUST ONLY BE PERFORMED BY AUTHORIZED AND PROPERLY TRAINED PERSONNEL.**

IMPORTANT

READ OPERATION MANUAL AND SAFETY INSTRUCTIONS FOR THIS TOOL BEFORE USING IT.

USE ONLY PARTS AND REPAIR PROCEDURES APPROVED BY STANLEY AND DESCRIBED IN THE OPERATION MANUAL.

TAG TO BE REMOVED ONLY BY TOOL OPERATOR.

SEE OTHER SIDE

SAFETY TAG P/N 15875 (Shown smaller than actual size)

HOSE TYPES

The rated working pressure of the hydraulic hose must be equal to or higher than the relief valve setting on the hydraulic system. There are three types of hydraulic hose that meet this requirement and are authorized for use with Stanley Hydraulic Tools. They are:

Certified non-conductive — constructed of thermoplastic or synthetic rubber inner tube, synthetic fiber braid reinforcement, and weather resistant thermoplastic or synthetic rubber cover. *Hose labeled **certified non-conductive** is the only hose authorized for use near electrical conductors.*

Wire-braided (conductive) — constructed of synthetic rubber inner tube, single or double wire braid reinforcement, and weather resistant synthetic rubber cover. *This hose is **conductive** and must never be used near electrical conductors.*

Fabric-braided (not certified or labeled non-conductive) — constructed of thermoplastic or synthetic rubber inner tube, synthetic fiber braid reinforcement, and weather resistant thermoplastic or synthetic rubber cover. *This hose is **not certified non-conductive** and must never be used near electrical conductors.*

HOSE SAFETY TAGS

To help ensure your safety, the following DANGER tags are attached to all hose purchased from Stanley Hydraulic Tools. DO NOT REMOVE THESE TAGS.

If the information on a tag is illegible because of wear or damage, replace the tag immediately. A new tag may be obtained from your Stanley Distributor.

THE TAG SHOWN BELOW IS ATTACHED TO “CERTIFIED NON-CONDUCTIVE” HOSE

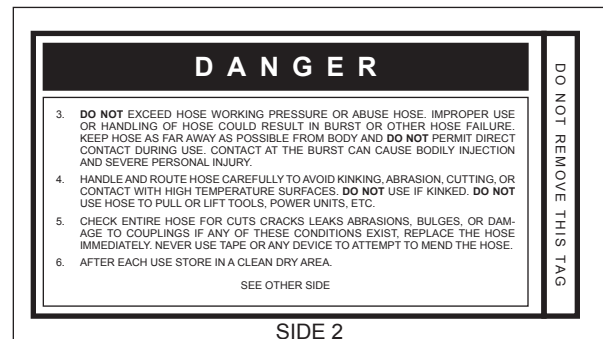
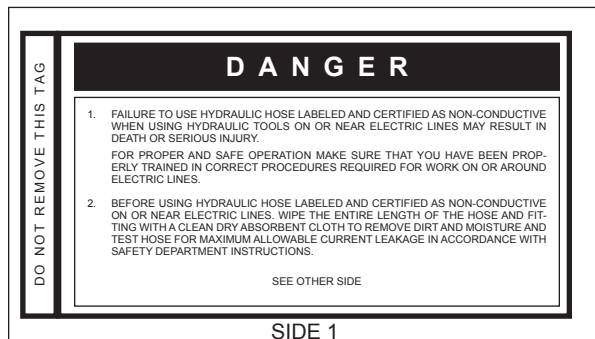

(Shown smaller than actual size)

THE TAG SHOWN BELOW IS ATTACHED TO “CONDUCTIVE” HOSE.

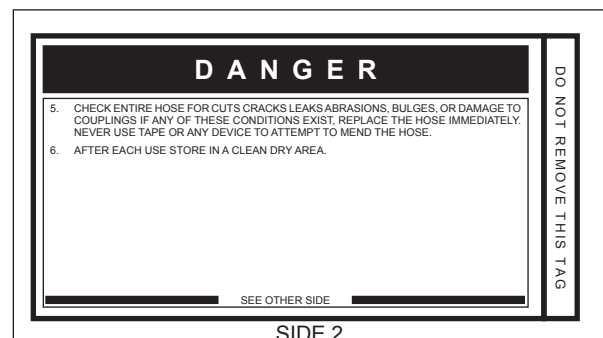
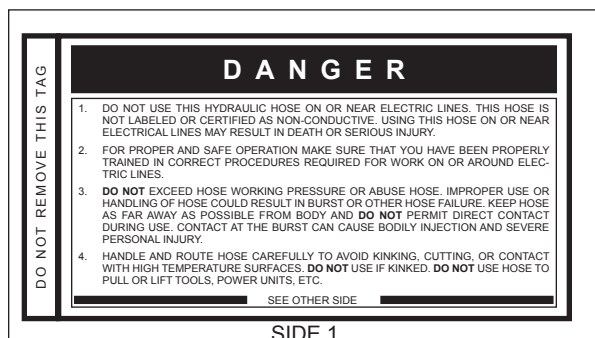

(Shown smaller than actual size)

HOSE RECOMMENDATIONS

Oil Flow		Hose Lengths		Inside Diameter		USE (Press/Return)	Min. Working Pressure	
GPM	LPM	FEET	METERS	INCH	MM		PSI	BAR
Certified Non-Conductive Hose - Fiber Braid - for Utility Bucket Trucks								
4-9	15-34	up to 10	up to 3	3/8	10	Both	2250	155
Conductive Hose - Wire Braid or Fiber Braid - DO NOT USE NEAR ELECTRICAL CONDUCTORS								
4-6	15-23	up to 25	up to 7.5	3/8	10	Both	2500	175
4-6	15-23	26-100	7.5-30	1/2	13	Both	2500	175
5-10.5	19-40	up to 50	up to 15	1/2	13	Both	2500	175
5-10.5	19-40	51-100	15-30	5/8	16	Both	2500	175
5-10.5	19-40	100-300	30-90	5/8	16	Pressure	2500	175
10-13	38-49	up to 50	up to 15	3/4	19	Return	2500	175
10-13	38-49	51-100	15-30	5/8	16	Both	2500	175
10-13	38-49	100-200	30-60	3/4	19	Pressure	2500	175
13-16	49-60	up to 25	up to 8	1	25.4	Return	2500	175
13-16	49-60	26-100	8-30	5/8	16	Pressure	2500	175
13-16	49-60	26-100	8-30	3/4	19	Return	2500	175
13-16	49-60	26-100	8-30	3/4	19	Pressure	2500	175
13-16	49-60	26-100	8-30	1	25.4	Return	2500	175

Tool to Hydraulic Circuit Hose Recommendations

The chart to the right shows recommended minimum hose diameters for various hose lengths based on gallons per minute (gpm)/liters per minute (lpm). These recommendations are intended to keep return line pressure (back pressure) to a minimum acceptable level to ensure maximum tool performance.

This chart is intended to be used for hydraulic tool applications only based on Stanley Hydraulic Tools tool operating requirements and should not be used for any other applications.

All hydraulic hose must have at least a rated minimum working pressure equal to the maximum hydraulic system relief valve setting.

All hydraulic hose must meet or exceed specifications as set forth by SAE J517.

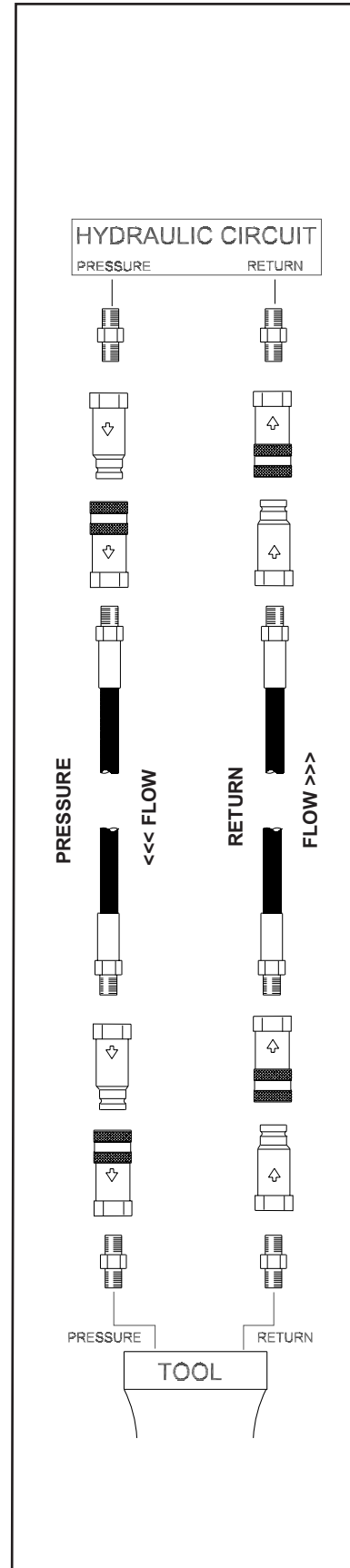

Figure 1. Typical Hose Connections

HTMA / EHTMA REQUIREMENTS

HTMA / EHTMA REQUIREMENTS

HTMA

HYDRAULIC SYSTEM REQUIREMENTS

TOOL TYPE

TYPE I TYPE II TYPE RR TYPE III

Flow Range	4-6 gpm (15-23 lpm)	7-9 gpm (26-34 lpm)	9-10.5 gpm (34-40 lpm)	11-13 gpm (42-49 lpm)
Nominal Operating Pressure (at the power supply outlet)	1500 psi (103 bar)	1500 psi (103 bar)	1500 psi (103 bar)	1500 psi (103 bar)
System relief valve setting (at the power supply outlet)	2100-2250 psi (145-155 bar)	2100-2250 psi (145-155 bar)	2200-2300 psi (152-159 bar)	2100-2250 psi (145-155 bar)
Maximum back pressure (at tool end of the return hose)	250 psi (17 bar)	250 psi (17 bar)	250 psi (17 bar)	250 psi (17 bar)
Measured at a max. fluid viscosity of: (at min. operating temperature)	400 ssu* (82 centistokes)	400 ssu* (82 centistokes)	400 ssu* (82 centistokes)	400 ssu* (82 centistokes)
Temperature: Sufficient heat rejection capacity to limit max. fluid temperature to: (at max. expected ambient temperature)	140° F (60° C)	140° F (60° C)	140° F (60° C)	140° F (60° C)
Min. cooling capacity at a temperature difference of between ambient and fluid temps	3 hp (2.24 kW) 40° F (22° C)	5 hp (3.73 kW) 40° F (22° C)	6 hp (5.22 kW) 40° F (22° C)	7 hp (4.47 kW) 40° F (22° C)
NOTE: Do not operate the tool at oil temperatures above 140° F (60° C). Operation at higher temperatures can cause operator discomfort at the tool.				
Filter Min. full-flow filtration Sized for flow of at least: (For cold temp. startup and max. dirt-holding capacity)	25 microns 30 gpm (114 lpm)	25 microns 30 gpm (114 lpm)	25 microns 30 gpm (114 lpm)	25 microns 30 gpm (114 lpm)
Hydraulic fluid Petroleum based (premium grade, anti-wear, non-conductive) Viscosity (at min. and max. operating temps)	100-400 ssu*	100-400 ssu* (20-82 centistokes)	100-400 ssu*	100-400 ssu*
NOTE: When choosing hydraulic fluid, the expected oil temperature extremes that will be experienced in service determine the most suitable temperature viscosity characteristics. Hydraulic fluids with a viscosity index over 140 will meet the requirements over a wide range of operating temperatures.				
*SSU = Saybolt Seconds Universal				

EHTMA HYDRAULIC SYSTEM REQUIREMENTS

CLASSIFICATION



Flow Range	3.5-4.3 gpm (13.5-16.5 lpm)	4.7-5.8 gpm (18-22 lpm)	7.1-8.7 gpm (27-33 lpm)	9.5-11.6 gpm (36-44 lpm)	11.8-14.5 gpm (45-55 lpm)
Nominal Operating Pressure (at the power supply outlet)	1870 psi (129 bar)	1500 psi (103 bar)	1500 psi (103 bar)	1500 psi (103 bar)	1500 psi (103 bar)
System relief valve setting (at the power supply outlet)	2495 psi (172 bar)	2000 psi (138 bar)	2000 psi (138 bar)	2000 psi (138 bar)	2000 psi (138 bar)

NOTE: These are general hydraulic system requirements. See tool specification page for tool specific requirements

OPERATION

PREOPERATION PROCEDURES

CHECK POWER SOURCE

1. Using a calibrated flow meter and pressure gauge, make sure the hydraulic power source develops a flow of 7–9 gpm/26–34 lpm at 1500–2000 psi/105–140 bar.
2. Make certain that the power source is equipped with a relief valve set to open at 2150–2250 psi/150–155 bar maximum.
3. Make certain that the power source return pressure does not exceed 250 psi/17 bar.
4. Make sure the trash pump inlet is clear of debris. Remove any obstruction before operating.

CONNECT HOSES

1. Wipe all hose couplers with a clean lint free cloth before making connections.

IMPORTANT

Do not connect pressure to the return port. Motor shaft seal limit is 250 psi/17 bar.

2. Connect the hoses from the hydraulic power source to the couplers on the trash pump or trash pump hoses. It is a good practice to connect return hose first and disconnect it last to minimize or avoid trapped pressure within the trash pump motor.

NOTE:

If uncoupled hoses are left in the sun, pressure increase inside the hoses might make them difficult to connect. Whenever possible, connect the free ends of the hoses together.

3. Observe the arrow on the couplers to ensure that the flow is in the proper direction. The female coupler on the trash pump is the inlet (pressure) coupler.

PUMP OPERATION

1. Observe all safety precautions.
2. Attach a 3-inch/76 mm diameter hose to the pump outlet. For best performance, keep the discharge hose as short as possible and lay it out to avoid sharp bends or kinks.

Do not attach a nozzle to the outlet end of the discharge hose. For high-pressure water pumping, use a Stanley SM20 or SM50 and nozzle. The TP03 is designed for high GPM water flow at low water pressure (head).

3. Attach a rope or cable to the trash pump's handle. Lower the trash pump into the liquid to be pumped. Do not raise or lower the trash pump by its hoses or couplers to avoid damage to the hoses or couplers.

IMPORTANT

Never point the hose at bystanders.

4. Turn on the hydraulic power source. Watch for solids in the liquid being pumped. If solids are excessive, the discharge flow might decrease. If this happens, stop the pump and check for the cause of the problem.

Under some conditions, the liquid being pumped might be slowed enough so it can no longer push particles in the liquid. If this happens, particles can accumulate in the pumping chamber, causing further restriction. The impeller then acts as a “grinding wheel” which causes accelerated trash pump wear. Reduced liquid flow can be caused by the following:

- The trash pump sinks into solids at the bottom of the hole.
- The end of the outlet hose is too high, causing an excessive lift height for the column of liquid being pushed by the trash pump. This slows the flow of liquid to a level where it can no longer carry solids.
- The flow and pressure of hydraulic fluid to the trash pump is too low, which reduces impeller speed. A 20 percent decrease in hydraulic fluid flow can reduce pump performance by 50 percent. When operating at reduced hydraulic flow and pressure, the end of the outlet hose should not be more than 30 ft/9 m above the liquid.

NOTE:

It will not damage the pump to operate it “dry.”

OPERATION

5. When pumping is complete, set the hydraulic control valve to the "OFF" position. Lift the trash pump from the work area using the rope or cable to avoid damage to the hoses or couplers.

IMPORTANT

Observe the following for trash pump protection and care.

6. The trash pump must maintain a minimum impeller speed in order to move solid particles through the pump. While pumping liquids containing large solids, monitor the flow from the outlet of the fire hose. If it begins to slow, turn off the hydraulic power source and lift the trash pump from the work area. Disconnect the hydraulic hoses and clean at the water hose and the pumping chamber.

IMPORTANT

Pumping liquids with a solids-to liquid ratio greater than 30 percent solids to 70 percent liquid will cause accelerated impeller wear.

7. To maintain optimum performance, it is good practice to periodically inspect the impeller for wear or damage. This is especially important following the pumping of liquids containing sharp, abrasive solids.

COLD WEATHER OPERATION

If the trash pump is to be used during cold weather, preheat the hydraulic fluid at low power source speed. When using the normally recommended fluids, fluid should be at or above 50 °F/10 °C (400 ssu/82 centistokes) before use.

Damage to the hydraulic system or pump motor seals can result from use with fluid that is too viscous or thick.

TOOL PROTECTION & CARE

NOTICE

In addition to the Safety Precautions found in this manual, observe the following for equipment protection and care.

- Make sure all couplers are wiped clean before connection.
- The hydraulic circuit control valve must be in the “OFF” position when coupling or uncoupling hydraulic tools. Failure to do so may result in damage to the quick couplers and cause overheating of the hydraulic system.
- Always store the tool in a clean dry space, safe from damage or pilferage.
- Make sure the circuit PRESSURE hose (with male quick disconnect) is connected to the “IN” port. The circuit RETURN hose (with female quick disconnect) is connected to the opposite port. Do not reverse circuit flow. This can cause damage to internal seals.
- Always replace hoses, couplings and other parts with replacement parts recommended by Stanley Hydraulic Tools. Supply hoses must have a minimum working pressure rating of 2500 psi/172 bar.
- Do not exceed the rated flow or pressure (refer to Specifications in this manual for correct flow rate and pressure). If specifications are exceeded, rapid failure of the internal seals may result.
- Always keep critical tool markings, such as warning stickers and tags legible.
- Tool repair should be performed by experienced personnel only.
- Make certain that the recommended relief valves are installed in the pressure side of the system.
- Do not use the tool for applications for which it was not intended.

TROUBLESHOOTING

If symptoms of poor performance develop, the following chart can be used as a guide to correct the problem.

When diagnosing faults in operation of the tool, always make sure the hydraulic power source is supplying the correct hydraulic flow and pressure as listed in the table. Use a flowmeter know to be accurate. Check the flow with the hydraulic fluid temperature at least 80 °F/27 °C.

PROBLEM	CAUSE	SOLUTION
Pump will not start.	No hydraulic fluid flow or pressure.	Turn on power unit and check that 7–9 gpm/26–34 lpm at 1500–2000 psi/105–140 bar is available at the trash pump.
	Defective couplers.	Check the couplers by connecting them together with the hydraulic power supply operating and with the control valve in the “ON” position. The power supply should operate without “loading” from the couplers.
	Impeller jammed with debris.	Clean the pumping chamber.
	Impeller rubbing against wear plates.	Check and adjust the impeller clearance.
	Defective power module.	Repair or replace the power module.
Poor pump performance.	Hydraulic flow reversed.	Check that the hoses are correctly connected to the pump motor ports. The female coupler should be connected to the “IN” port. The return fluid must never flow through a reversing valve.
	Improper hydraulic fluid flow.	Check that 7–9 gpm/26–34 lpm at 1500–2000 psi/105–140 bar is available at the trash pump. A 20% decrease in flow can result in a 50% decrease in pump performance. 8 gpm/30 lpm is the best circuit flow.
	Trash pump submersed in sediment.	Lift the pump from the bottom of the hole or chamber. Use a flat support under the pump if necessary.
	Trash pump inlet restricted.	Remove restriction and thoroughly clean.
	Discharge hose kinked or restricted.	Straighten the hoses. If the hose must bend at the top of the hole, use a piece of split rigid conduit with large diameter of the expanded hose. This keeps the hose from kinking. Use a 90° 3-inch pipe elbow on the trash pump outlet if necessary.
	Discharge hose too small.	Use a 3-inch diameter hose.
	Water lift too high.	Lower the outlet end of the discharge hose.
	Impeller worn or damaged.	Check impeller for damage and excessive wear. Replace if necessary.
	Wear plates worn or damaged.	Check wear plates for damage and excessive wear. Replace if necessary.
Hydraulic fluid in discharge flow.	Motor shaft seal failure.	Replace the motor shaft seal. Ensure power unit is delivering 7–9 gpm/26–34 lpm

SPECIFICATIONS

Capacity.....	450 gpm/1688 lpm
Weight	31 lbs/14 kg
Height (over handle).....	16.5 in./42 cm
Length.....	14 in./35.5 cm
Width	16 in./41 cm
Pressure	1500–2000 psi/105–140 bar
Flow Range	7–9 gpm/26–34 lpm
Maximum Flow	9 gpm/34 lpm
Porting	1/2 in. NPTF
Connect Size and Type	1/2 in. Male Pipe
Discharge Diameter.....	3 in./76.2 mm Camlock
Inlet Diameter	3 in./76.2 mm
System Type.....	OC, HTMA Type II
HTMA Class II.....	7–9 gpm @ 2000 psi
EHTMA Category.....	30 lpm @ 138 bar
Sound Pressure.....	<85 dBA @ 1m
Vibration Level.....	N/A

ACCESSORIES

Description	Part No.
Adapter, 3 in. NPT/3 in. Camlock Male.....	52720
Lay-Flat Discharge Hose, 3 in. × 25 ft with Camlock Fittings	56761

TP03 PARTS ILLUSTRATION

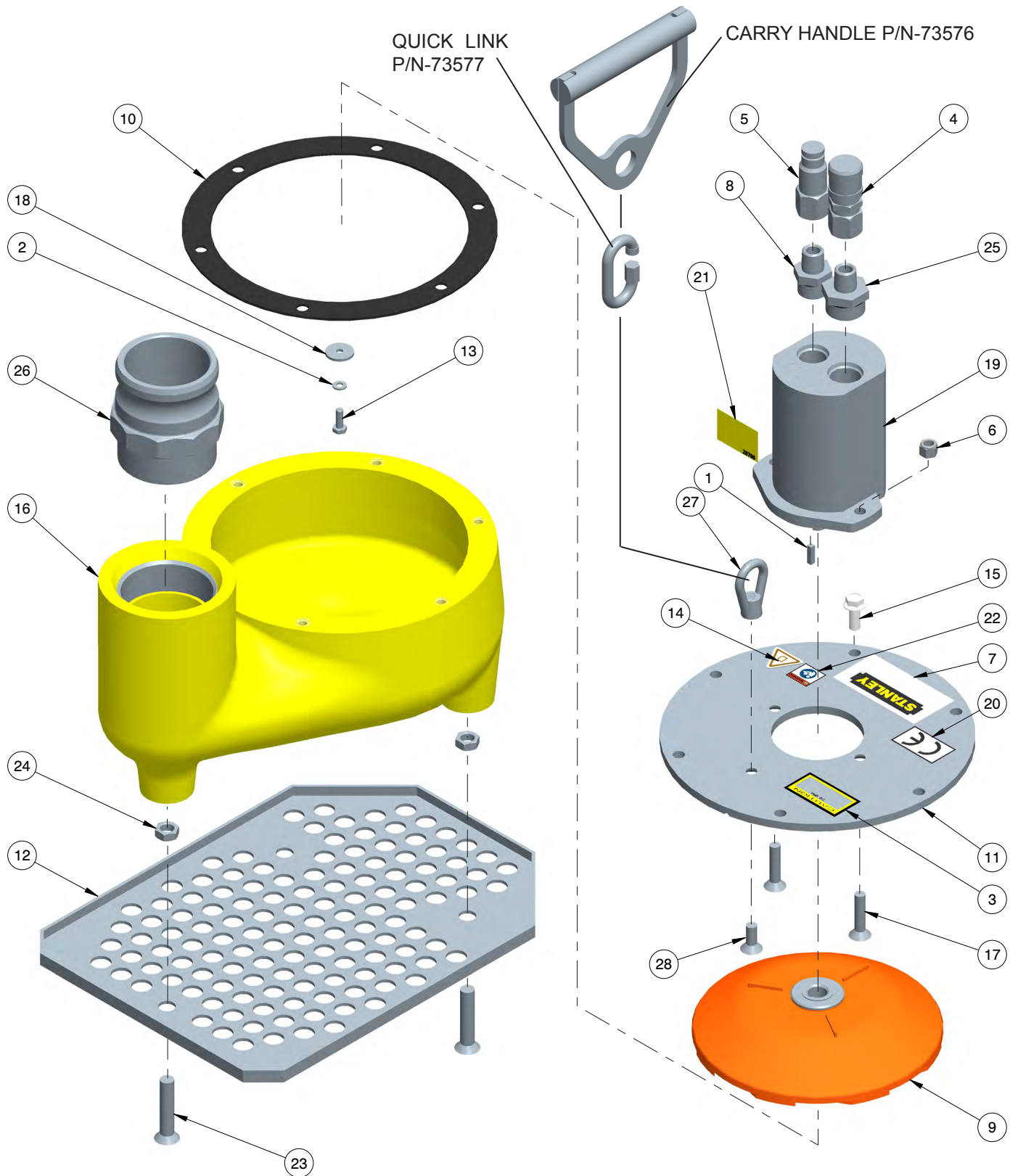

TP03 PARTS LIST

ITEM NO.	PART NO.	QTY	DESCRIPTION
1	00635	1	Key
2	01324	1	LOCKWASHER 1/4" I.D.
3	03786	1	GPM STICKER
4	03975	1	COUPLER,3/8 FEM 1/2NPT
5	03976	1	COUPLER,3/8MALE 1/2NPT
6	04353	2	NYLOCK NUT 3/8-16UNC
7	05152	1	STANLEY STICKER
8	06264	1	ADAPTER -12 SAE X 1/2 NPT
9	07200	1	IMPELLER ASSY
10	07201	1	TP03 GASKET
11	73356	1	MOTOR ADAPTOR PLATE
12	07206	1	BASE PLATE
13	09661	1	HHCS 1/4-28UNF X .750 SST
14	11207	1	CIRCUIT TYPE "D" STICKER
15	19534	6	HEX FLANGE BOLT 3/8-16 X 1
16	73067	1	URETHANE BOWL YELLOW
	51301	1	URETHANE BOWL TP0300303 ARMY MODEL ONLY
17	21978	2	CAPSCREW 3/8-16 X 1.75
18	22294	1	WASHER 1"OD X 1/4 ID SST
19	24381	1	HYDRAULIC MOTOR
20	28322	1	STICKER "CE" 25MM
21	28786	1	COUPLER STICKER
22	28788	1	STICKER - MANUAL
23	38701	3	CAPSCREW 1/2-13 X 2.5
24	38702	3	HEX JAM NUT 1/2-13UNC
25	39426	1	ADAPTER -14 SAE X 1/2 NPT
26	52720	1	CAMLOCK COUPLING 3"
27	73058	1	LIFTING EYE NUT 3/8-16
28	73061	1	CAPSCREW 3/8-16 X 1
	66401	1	SEAL KIT (JIHOSTRO BRAND MOTOR ONLY) FOR P/N-24381 MOTOR
	26230	1	SEAL KIT (CASAPPA BRAND MOTOR ONLY)
	73434	1	OUTPUT SHAFT FOR P/N-24381 MOTOR ONLY
	03974	1	COUPLER SET (MALE & FEMALE)
	73576	1	CARRYING HANDLE (SEE EXPLODED VIEW)
	73577	1	QUICK LINK (SEE EXPLODED VIEW)

UNDERWATER TOOLS DEPTH GUIDELINE

UNDERWATER MODELS ONLY

⚠ CAUTION

DO NOT USE HYDRAULIC TOOLS UNDERWATER THAT ARE NOT DESIGNATED AS AN “UNDERWATER” MODEL, OR THIS WILL RESULT IN DAMAGE TO THE TOOL.

For underwater hydraulic tools the applications are broken down into four quadrants depending on type of tool and method of operation.

The types of tools are percussive and rotational, each with different characteristics allowing for different depth operation. With percussive tools, the nitrogen accumulator PSI must counter the increase in ambient pressure found at lower depths. Since there is a maximum PSI for percussive tools they are limited to certain depths. Rotational tools do not have accumulators and thus capable of deeper depths.

The methods are broken into diver operated or remote operated vehicle (ROV). ROV's can reach lower depths and with an on-board hydraulic power source that is depth compensated, can operate hydraulic tools at depths of thousands of feet. ROV operation is still limited to the tool, for example a percussive tool has the same depth limitation whether ROV or diver operated.



Operation Overview

	Percussive	Rotational
Diver	Tools: Breakers, Hammer Drills and Chipping Hammers Max Depth: 500' - limitations due to accumulator PSI max (increase 40 PSI for every 100')	Tools: Grinders, Saws, Chain Saws Max Depth: 1000' - Reference hose sizing guide below
ROV	Tools: Breakers, Hammer Drills and Chipping Hammers Max Depth: 500' - limitations due to accumulator PSI max (increase 40 PSI for every 100')	Tools: Grinders, Saws, Chain Saws Max Depth: 1000' - Reference hose sizing guide below

Recommended Hose Diameters

Depth (ft)	8 GPM	12 GPM
100	5/8"	5/8"
300	3/4"	1"
600	1"	1"
1000	1"	1-1/4"



STANLEY®

Stanley Hydraulic Tools
3810 SE Naef Road
Milwaukie, Oregon 97267-5698 USA
(503) 659-5660 / Fax (503) 652-1780
www.stanleyhydraulics.com

Free Manuals Download Website

<http://myh66.com>

<http://usermanuals.us>

<http://www.somanuals.com>

<http://www.4manuals.cc>

<http://www.manual-lib.com>

<http://www.404manual.com>

<http://www.luxmanual.com>

<http://aubethermostatmanual.com>

Golf course search by state

<http://golfingnear.com>

Email search by domain

<http://emailbydomain.com>

Auto manuals search

<http://auto.somanuals.com>

TV manuals search

<http://tv.somanuals.com>