

# STANLEY®

## SM50 HYDRAULIC SUMP PUMP



### USER MANUAL Safety, Operation and Maintenance



© 2014 Stanley Black & Decker, Inc.  
New Britain, CT 06053  
U.S.A.  
52724 2/2015 Ver. 6

# DECLARATION OF CONFORMITY

DECLARATION OF CONFORMITY  
ÜBEREINSTIMMUNGS-ERKLÄRUNG  
DECLARATION DE CONFORMITE CEE  
DECLARACION DE CONFORMIDAD  
DICHIARAZIONE DI CONFORMITA



I, the undersigned:  
Ich, der Unterzeichnende:  
Je soussigné:  
El abajo firmante:  
Io sottoscritto:

**Weisbeck, Andy**

Surname and First names/Familiennname und Vornamen/Nom et prénom/Nombre y apellido/Cognome e nome

hereby declare that the equipment specified hereunder:  
bestätige hiermit, daß erklaren Produkt genannten Werk oder Gerät:  
déclare que l'équipement visé ci-dessous:  
Por la presente declaro que el equipo se especifica a continuación:  
Dichiaro che le apparecchiature specificate di seguito:

- Category: **Submersible Pump, Hydraulic**  
Kategorie:  
Catégorie:  
Categoria:  
Categoria:
- Make/Marke/Marque/Marca/Marca **Stanley**
- Type/Typ/Type/Tipo/Tipo: **SM50100, SM50100L**
- Serial number of equipment:  
Seriennummer des Geräts:  
Numéro de série de l'équipement:  
Numero de serie del equipo:  
Matricola dell'attrezzatura:  
**All**

Has been manufactured in conformity with  
Wurde hergestellt in Übereinstimmung mit  
Est fabriqué conformément  
Ha sido fabricado de acuerdo con  
E' stata costruita in conformità con

Directive/Standards Richtlinie/Standards Directives/Normes Directriz/Los Normas Direttiva/Norme	No. Nr Numéro No n.	Approved body Prüfung durch Organisme agréé Aprobado Collaudato
EN Machinery Directive	809:2009 2006/42/EC:2006	Self Self

- Special Provisions: **None**  
Spezielle Bestimmungen:  
Dispositions particulières:  
Provisiones especiales:  
Disposizioni speciali:
- Representative in the Union: **Patrick Vervier, Stanley Dubuis 17-19, rue Jules Berthonneau-BP 3406 41034 Blois Cedex, France.**  
Vertreter in der Union/Représentant dans l'union/Representante en la Union/Rappresentante presso l'Unione

Done at/Ort/Fait à/Dado en/Fatto a Stanley Hydraulic Tools, Milwaukie, Oregon USA Date/Datum/le/Fecha/Data 1-5-11

Signature/Unterschrift/Signature/Firma/Firma

Position/Position/Fonction/Cargo/Posizione Director of Product Development

# TABLE OF CONTENTS

DECLARATION OF CONFORMITY .....	2
SAFETY SYMBOLS .....	4
SAFETY PRECAUTIONS.....	5
TOOL STICKERS & TAGS .....	6
HOSE TYPES.....	7
HOSE RECOMMENDATIONS .....	8
FIGURE 1. TYPICAL HOSE CONNECTIONS .....	8
HTMA REQUIREMENTS.....	9
OPERATION.....	10
TOOL PROTECTION & CARE .....	12
TROUBLESHOOTING .....	13
SPECIFICATIONS.....	14
ACCESSORIES.....	14
SM59 PARTS ILLUSTRATION .....	15
SM50 PARTS LIST .....	16
UNDERWATER TOOLS DEPTH GUIDELINE.....	17

## IMPORTANT

To fill out a Product Warranty Validation form, and for information on your warranty, visit [Stanleyhydraulics.com](http://Stanleyhydraulics.com) and select the Company tab, Warranty.  
(NOTE: The warranty Validation record must be submitted to validate the warranty).

**SERVICING:** This manual contains safety, operation, and routine maintenance instructions. Stanley Hydraulic Tools recommends that servicing of hydraulic tools, other than routine maintenance, must be performed by an authorized and certified dealer. Please read the following warning.

## ⚠ WARNING

**SERIOUS INJURY OR DEATH COULD RESULT FROM THE IMPROPER REPAIR OR SERVICE OF THIS TOOL.**

**REPAIRS AND / OR SERVICE TO THIS TOOL MUST ONLY BE DONE BY AN AUTHORIZED AND CERTIFIED DEALER.**

For the nearest authorized and certified dealer, call Stanley Hydraulic Tools at the number listed on the back of this manual and ask for a Customer Service Representative.

# SAFETY SYMBOLS

Safety symbols and signal words, as shown below, are used to emphasize all operator, maintenance and repair actions which, if not strictly followed, could result in a life-threatening situation, bodily injury or damage to equipment.



This is the safety alert symbol. It is used to alert you to potential personal injury hazards. Obey all safety messages that follow this symbol to avoid possible injury or death.



This safety alert and signal word indicate an imminently hazardous situation which, if not avoided, will result in death or serious injury.



This safety alert and signal word indicate a potentially hazardous situation which, if not avoided, could result in death or serious injury.



This safety alert and signal word indicate a potentially hazardous situation which, if not avoided, could result in death or serious injury.



This signal word indicates a potentially hazardous situation which, if not avoided, may result in property damage.



This signal word indicates a situation which, if not avoided, will result in damage to the equipment.



This signal word indicates a situation which, if not avoided, may result in damage to the equipment.

Always observe safety symbols. They are included for your safety and for the protection of the tool.

## LOCAL SAFETY REGULATIONS

Enter any local safety regulations here. Keep these instructions in an area accessible to the operator and maintenance personnel.

---

---

---

---

---

---

---

---

---

---

---

---

---

---

---

---

---

---

---

---

---

---

---

---

---

# SAFETY PRECAUTIONS

Tool operators and maintenance personnel must always comply with the safety precautions given in this manual and on the stickers and tags attached to the tool and hose.

These safety precautions are given for your safety. Review them carefully before operating the tool and before performing general maintenance or repairs.

Supervising personnel should develop additional precautions relating to the specific work area and local safety regulations. If so, place the added precautions in the space provided in this manual.

The models SM50 Hydraulic Pump will provide safe and dependable service if operated in accordance with the instructions given in this manual. Read and understand this manual and any stickers and tags attached to the pump and hoses before operation. Failure to do so could result in personal injury or equipment damage.



- Operator must start in a work area without bystanders. The operator must be familiar with all prohibited work areas such as excessive slopes and dangerous terrain conditions.
- Establish a training program for all operators to ensure safe operations.
- Do not operate the tool unless thoroughly trained or under the supervision of an instructor.
- Always wear safety equipment such as goggles, head protection, and safety shoes at all times when operating the tool.
- Do not inspect or clean the tool while the hydraulic power source is connected. Accidental engagement of the tool can cause serious injury.
- Do not operate this tool without first reading the Operation section of this manual.
- Do not install or remove this tool while the hydraulic power source is connected. Accidental engagement of the tool can cause serious injury.
- Never operate the tool near energized transmission lines. Know the location of buried or covered services before starting work.
- Do not wear loose fitting clothing when operating the tool. Loose fitting clothing can get entangled with the tool and cause serious injury.
- Supply hoses must have a minimum working pressure rating of 2500 psi/175 bar.
- Be sure all hose connections are tight.
- The hydraulic circuit control valve must be in the "OFF" position when coupling or uncoupling the tool. Wipe all couplers clean before connecting. Failure to do so may result in damage to the quick couplers and cause overheating. Use only lint-free cloths.
- Do not operate the tool at oil temperatures above 140 ° F/60 ° C. Operation at higher oil temperatures can cause operator discomfort and may cause damage to the tool.
- Do not operate a damaged, improperly adjusted, or incompletely assembled tool.
- To avoid personal injury or equipment damage, all tool repair, maintenance and service must only be performed by authorized and properly trained personnel.
- Do not exceed the rated limits of the tool or use the tool for applications beyond its design capacity.
- Always keep critical tool markings, such as labels and warning stickers legible.
- Always replace parts with replacement parts recommended by Stanley Hydraulic Tools.
- Check fastener tightness often and before each use daily.

# TOOL STICKERS & TAGS

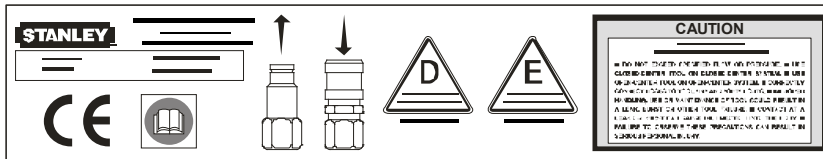

52728  
SM50 Combined Decal

## NOTE:

THE INFORMATION LISTED ON THE STICKERS SHOWN, MUST BE LEGIBLE AT ALL TIMES.

REPLACE DECALS IF THEY BECOME WORN OR DAMAGED. REPLACEMENTS ARE AVAILABLE FROM YOUR LOCAL STANLEY DISTRIBUTOR.

The safety tag (P/N 15875) at right is attached to the tool when shipped from the factory. Read and understand the safety instructions listed on this tag before removal. We suggest you retain this tag and attach it to the tool when not in use.

## DANGER

1. FAILURE TO USE HYDRAULIC HOSE LABELED AND CERTIFIED AS NON-CONDUCTIVE WHEN USING HYDRAULIC TOOLS ON OR NEAR ELECTRICAL LINES MAY RESULT IN DEATH OR SERIOUS INJURY.

BEFORE USING HOSE LABELED AND CERTIFIED AS NON-CONDUCTIVE ON OR NEAR ELECTRICAL LINES BE SURE THE HOSE IS MAINTAINED AS NON-CONDUCTIVE. THE HOSE SHOULD BE REGULARLY TESTED FOR ELECTRIC CURRENT LEAKAGE IN ACCORDANCE WITH YOUR SAFETY DEPARTMENT INSTRUCTIONS.

2. A HYDRAULIC LEAK OR BURST MAY CAUSE OIL INJECTION INTO THE BODY OR CAUSE OTHER SEVERE PERSONAL INJURY.
  - A. DO NOT EXCEED SPECIFIED FLOW AND PRESSURE FOR THIS TOOL. EXCESS FLOW OR PRESSURE MAY CAUSE A LEAK OR BURST.
  - B. DO NOT EXCEED RATED WORKING PRESSURE OF HYDRAULIC HOSE USED WITH THIS TOOL. EXCESS PRESSURE MAY CAUSE A LEAK OR BURST.
  - C. CHECK TOOL HOSE COUPLERS AND CONNECTORS DAILY FOR LEAKS. DO NOT FEEL FOR LEAKS WITH YOUR HANDS. CONTACT WITH A LEAK MAY RESULT IN SEVERE PERSONAL INJURY.

## IMPORTANT

READ OPERATION MANUAL AND SAFETY INSTRUCTIONS FOR THIS TOOL BEFORE USING IT.

USE ONLY PARTS AND REPAIR PROCEDURES APPROVED BY STANLEY AND DESCRIBED IN THE OPERATION MANUAL.

TAG TO BE REMOVED ONLY BY TOOL OPERATOR.

SEE OTHER SIDE

## DANGER

- D. DO NOT LIFT OR CARRY TOOL BY THE HOSES. DO NOT ABUSE HOSE. DO NOT USE KINKED, TORN OR DAMAGED HOSE.
3. MAKE SURE HYDRAULIC HOSES ARE PROPERLY CONNECTED TO THE TOOL BEFORE PRESSURING SYSTEM. SYSTEM PRESSURE HOSE MUST ALWAYS BE CONNECTED TO TOOL "IN" PORT. SYSTEM RETURN HOSE MUST ALWAYS BE CONNECTED TO TOOL "OUT" PORT. REVERSING CONNECTIONS MAY CAUSE REVERSE TOOL OPERATION WHICH CAN RESULT IN SEVERE PERSONAL INJURY.
4. DO NOT CONNECT OPEN-CENTER TOOLS TO CLOSED-CENTER HYDRAULIC SYSTEMS. THIS MAY RESULT IN LOSS OF OTHER HYDRAULIC FUNCTIONS POWERED BY THE SAME SYSTEM AND/OR SEVERE PERSONAL INJURY.
5. BYSTANDERS MAY BE INJURED IN YOUR WORK AREA. KEEP BYSTANDERS CLEAR OF YOUR WORK AREA.
6. WEAR HEARING, EYE, FOOT, HAND AND HEAD PROTECTION.
7. TO AVOID PERSONAL INJURY OR EQUIPMENT DAMAGE, ALL TOOL REPAIR MAINTENANCE AND SERVICE MUST ONLY BE PERFORMED BY AUTHORIZED AND PROPERLY TRAINED PERSONNEL.

## IMPORTANT

READ OPERATION MANUAL AND SAFETY INSTRUCTIONS FOR THIS TOOL BEFORE USING IT.

USE ONLY PARTS AND REPAIR PROCEDURES APPROVED BY STANLEY AND DESCRIBED IN THE OPERATION MANUAL.

TAG TO BE REMOVED ONLY BY TOOL OPERATOR.

SEE OTHER SIDE

SAFETY TAG P/N 15875 (Shown smaller than actual size)

# HOSE TYPES

The rated working pressure of the hydraulic hose must be equal to or higher than the relief valve setting on the hydraulic system. There are three types of hydraulic hose that meet this requirement and are authorized for use with Stanley Hydraulic Tools. They are:

**Certified non-conductive** — constructed of thermoplastic or synthetic rubber inner tube, synthetic fiber braid reinforcement, and weather resistant thermoplastic or synthetic rubber cover. *Hose labeled **certified non-conductive** is the only hose authorized for use near electrical conductors.*

**Wire-braided** (conductive) — constructed of synthetic rubber inner tube, single or double wire braid reinforcement, and weather resistant synthetic rubber cover. *This hose is **conductive** and must never be used near electrical conductors.*

**Fabric-braided** (not certified or labeled non-conductive) — constructed of thermoplastic or synthetic rubber inner tube, synthetic fiber braid reinforcement, and weather resistant thermoplastic or synthetic rubber cover. *This hose is **not certified non-conductive** and must never be used near electrical conductors.*

## HOSE SAFETY TAGS

To help ensure your safety, the following DANGER tags are attached to all hose purchased from Stanley Hydraulic Tools. DO NOT REMOVE THESE TAGS.

If the information on a tag is illegible because of wear or damage, replace the tag immediately. A new tag may be obtained from your Stanley Distributor.

### THE TAG SHOWN BELOW IS ATTACHED TO “CERTIFIED NON-CONDUCTIVE” HOSE

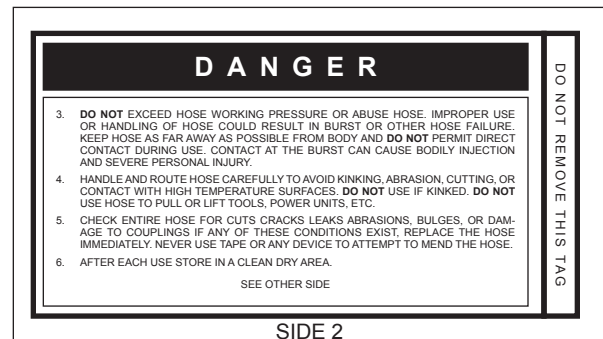
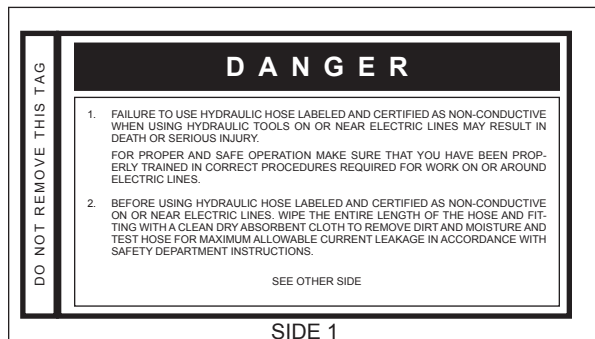

(Shown smaller than actual size)

### THE TAG SHOWN BELOW IS ATTACHED TO “CONDUCTIVE” HOSE.

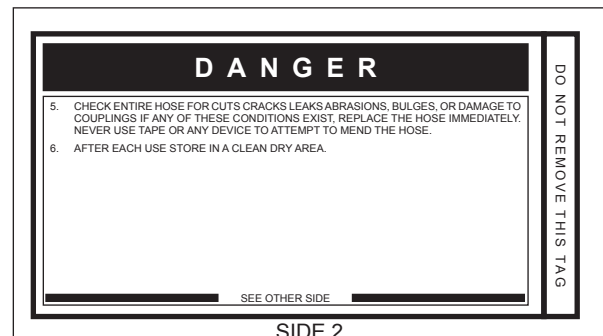
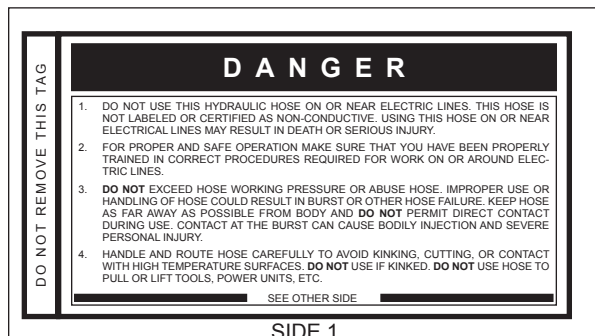

(Shown smaller than actual size)

# HOSE RECOMMENDATIONS

## Tool to Hydraulic Circuit Hose Recommendations

The chart to the right shows recommended minimum hose diameters for various hose lengths based on gallons per minute (gpm)/liters per minute (lpm). These recommendations are intended to keep return line pressure (back pressure) to a minimum acceptable level to ensure maximum tool performance.

This chart is intended to be used for hydraulic tool applications only based on Stanley Hydraulic Tools tool operating requirements and should not be used for any other applications. All hydraulic hose must have at least a rated minimum working pressure equal to the maximum hydraulic system relief valve setting.

**All hydraulic hose must meet or exceed specifications as set forth by SAE J517.**

Oil Flow		Hose Lengths		Inside Diameter		USE (Press/Return)	Min. Working Pressure	
GPM	LPM	FEET	METERS	INCH	MM		PSI	BAR
<b>Certified Non-Conductive Hose - Fiber Braid - for Utility Bucket Trucks</b>								
4-9	15-34	up to 10	up to 3	3/8	10	Both	2250	155
<b>Conductive Hose - Wire Braid or Fiber Braid - DO NOT USE NEAR ELECTRICAL CONDUCTORS</b>								
4-6	15-23	up to 25	up to 7.5	3/8	10	Both	2500	175
4-6	15-23	26-100	7.5-30	1/2	13	Both	2500	175
5-10.5	19-40	up to 50	up to 15	1/2	13	Both	2500	175
5-10.5	19-40	51-100	15-30	5/8	16	Both	2500	175
5-10.5	19-40	100-300	30-90	5/8	16	Pressure	2500	175
10-13	38-49	up to 50	up to 15	3/4	19	Return	2500	175
10-13	38-49	51-100	15-30	5/8	16	Both	2500	175
10-13	38-49	100-200	30-60	3/4	19	Pressure	2500	175
13-16	49-60	up to 25	up to 8	5/8	16	Return	2500	175
13-16	49-60	26-100	8-30	3/4	19	Pressure	2500	175
13-16	49-60	26-100	8-30	1	25.4	Return	2500	175

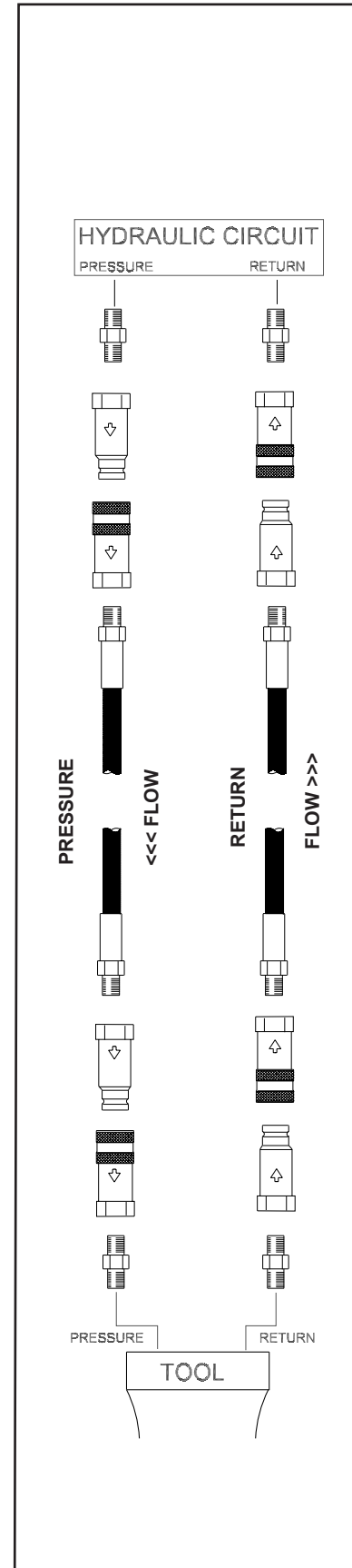

Figure 1. Typical Hose Connections



# HTMA / EHTMA REQUIREMENTS

## HTMA / EHTMA REQUIREMENTS

### HTMA





#### HYDRAULIC SYSTEM REQUIREMENTS

#### TOOL TYPE

	TYPE I	TYPE II	TYPE RR	TYPE III
Flow Range	4-6 gpm (15-23 lpm)	7-9 gpm (26-34 lpm)	9-10.5 gpm (34-40 lpm)	11-13 gpm (42-49 lpm)
Nominal Operating Pressure (at the power supply outlet)	1500 psi (103 bar)	1500 psi (103 bar)	1500 psi (103 bar)	1500 psi (103 bar)
System relief valve setting (at the power supply outlet)	2100-2250 psi (145-155 bar)	2100-2250 psi (145-155 bar)	2200-2300 psi (152-159 bar)	2100-2250 psi (145-155 bar)
Maximum back pressure (at tool end of the return hose)	250 psi (17 bar)	250 psi (17 bar)	250 psi (17 bar)	250 psi (17 bar)
Measured at a max. fluid viscosity of: (at min. operating temperature)	400 ssu* (82 centistokes)	400 ssu* (82 centistokes)	400 ssu* (82 centistokes)	400 ssu* (82 centistokes)
Temperature: Sufficient heat rejection capacity to limit max. fluid temperature to: (at max. expected ambient temperature)	140° F (60° C)	140° F (60° C)	140° F (60° C)	140° F (60° C)
Min. cooling capacity at a temperature difference of between ambient and fluid temps	3 hp (2.24 kW) 40° F (22° C)	5 hp (3.73 kW) 40° F (22° C)	6 hp (5.22 kW) 40° F (22° C)	7 hp (4.47 kW) 40° F (22° C)
<b>NOTE:</b> Do not operate the tool at oil temperatures above 140° F (60° C). Operation at higher temperatures can cause operator discomfort at the tool.				
Filter Min. full-flow filtration Sized for flow of at least: (For cold temp. startup and max. dirt-holding capacity)	25 microns 30 gpm (114 lpm)	25 microns 30 gpm (114 lpm)	25 microns 30 gpm (114 lpm)	25 microns 30 gpm (114 lpm)
Hydraulic fluid Petroleum based (premium grade, anti-wear, non-conductive) Viscosity (at min. and max. operating temps)	100-400 ssu*	100-400 ssu* (20-82 centistokes)	100-400 ssu*	100-400 ssu*
<b>NOTE:</b> When choosing hydraulic fluid, the expected oil temperature extremes that will be experienced in service determine the most suitable temperature viscosity characteristics. Hydraulic fluids with a viscosity index over 140 will meet the requirements over a wide range of operating temperatures.				
*SSU = Saybolt Seconds Universal				

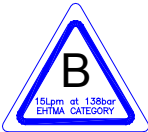
### EHTMA HYDRAULIC SYSTEM REQUIREMENTS

### CLASSIFICATION

					
Flow Range	3.5-4.3 gpm (13.5-16.5 lpm)	4.7-5.8 gpm (18-22 lpm)	7.1-8.7 gpm (27-33 lpm)	9.5-11.6 gpm (36-44 lpm)	11.8-14.5 gpm (45-55 lpm)
Nominal Operating Pressure (at the power supply outlet)	1870 psi (129 bar)	1500 psi (103 bar)	1500 psi (103 bar)	1500 psi (103 bar)	1500 psi (103 bar)
System relief valve setting (at the power supply outlet)	2495 psi (172 bar)	2000 psi (138 bar)	2000 psi (138 bar)	2000 psi (138 bar)	2000 psi (138 bar)

**NOTE:** These are general hydraulic system requirements. See tool specification page for tool specific requirements

# OPERATION

## PREOPERATION PROCEDURES

### CHECK POWER SOURCE

1. Using a calibrated flow meter and pressure gauge, make sure the hydraulic power source develops a flow of 7–12 gpm/26–45 lpm at 1000–2000 psi/70–140 bar.
2. Make certain that the power source is equipped with a relief valve set to open at 2100 psi/145 bar maximum.
3. Make certain that the power source return pressure does not exceed 250 psi/17 bar.
4. Make sure the trash pump inlet is clear of debris. Remove any obstruction before operating. Refer to PUMP CLEANING PROCEDURES.

### CONNECT HOSES

1. Wipe all hose couplers with a clean lint free cloth before making connections.
2. Connect the hoses from the hydraulic power source to the couplers on the trash pump or trash pump hoses. It is a good practice to connect return hose first and disconnect it last to minimize or avoid trapped pressure within the trash pump motor.

#### NOTE:

**If uncoupled hoses are left in the sun, pressure increase inside the hoses might make them difficult to connect. Whenever possible, connect the free ends of the hoses together.**

3. Observe the arrow on the couplers to ensure that the flow is in the proper direction. The female coupler on the trash pump is the inlet (pressure) coupler.

## PUMP OPERATION

1. Observe all safety precautions.

#### NOTE:

**The SM50 is not designed for use with a suction pipe inlet. The diameter of the suction screen at the bottom of the pump provides maximum pump efficiency. Reducing the size of this inlet will greatly reduce pump performance.**

2. Connect a hose fitted with a 3 inch/76.2 mm female camlock coupler to the pump outlet fitting. Make sure the fitting is securely tightened. For best performance, keep the hose as short as possible and lay it out to avoid sharp bends or kinks.
3. Lower the pump into the liquid to be pumped. Locate the outlet end of the discharge hose to disperse the liquid as required. Remove any kinks from the hose to assure maximum water flow.

## IMPORTANT

Never point the hose at bystanders.

4. Turn on the hydraulic power source. Watch for solids in the liquid being pumped. If solids are excessive, the discharge flow might decrease. If this happens, stop the pump and check for the cause of the problem.

Under some conditions, the liquid being pumped might be slowed enough so it can no longer push particles in the liquid. If this happens, particles can accumulate in the hose and backup the pumping chamber, causing further restriction. The impeller then acts as a “grinding wheel” which causes accelerated pump wear. Reduced liquid flow can be caused by the following:

- The pump sinks into solids at the bottom of the hole.
  - The end of the outlet hose is too high, causing an excessive lift height for the column of liquid being pushed by the trash pump. This slows the flow of liquid to a level where it can no longer carry solids out the end of the hose.
  - The flow and pressure of hydraulic fluid to the pump is too low, which reduces impeller speed. A 20% decrease in hydraulic fluid flow can reduce pump performance by 50%. When operating at reduced hydraulic flow and pressure, the end of the outlet hose should not be more than 30 ft/9 m above the liquid.
5. When pumping is complete, set the hydraulic control valve to the “OFF” position. Lift the pump from the work area.

## COLD WEATHER OPERATION

If the trash pump is to be used during cold weather, preheat the hydraulic fluid at low power source speed. When using the normally recommended fluids, fluid should be at or above 50 °F/10 °C (400 ssu/82 centistokes) before use.

Damage to the hydraulic system or pump motor seals can result from use with fluid that is too viscous or thick.

## CLEANING THE PUMPING CHAMBER

Debris such as weeds, sand and other solids may become trapped in the water hose and pumping chamber. This can reduce pump performance. It is important that the pumping chamber be kept clean at all times. The chamber can be cleaned as follows:

1. Remove motor and impeller by removing the two M12 × 1.75 Hex Head capscrews.
2. Remove all debris from the pump screen.
3. Thoroughly clean the volute and impeller. Do not remove the impeller unless necessary for repair or replacement or to remove trapped debris.
4. Assemble the motor and impeller to the volute. Clean the capscrews and lubricate the threads with underwater grease before installation.
5. Remove all debris from the hose. Otherwise, solids will backfill the pump.

# TOOL PROTECTION & CARE

## NOTICE

In addition to the Safety Precautions found in this manual, observe the following for equipment protection and care.

- Make sure all couplers are wiped clean before connection.
- The hydraulic circuit control valve must be in the “OFF” position when coupling or uncoupling hydraulic tools. Failure to do so may result in damage to the quick couplers and cause overheating of the hydraulic system.
- Always store the tool in a clean dry space, safe from damage or pilferage.
- Make sure the circuit PRESSURE hose (with male quick disconnect) is connected to the “IN” port. The circuit RETURN hose (with female quick disconnect) is connected to the opposite port. Do not reverse circuit flow. This can cause damage to internal seals.
- Always replace hoses, couplings and other parts with replacement parts recommended by Stanley Hydraulic Tools. Supply hoses must have a minimum working pressure rating of 2500 psi/172 bar.
- Do not exceed the rated flow (see Specifications) in this manual for correct flow rate and model number. Rapid failure of the internal seals may result.
- Always keep critical tool markings, such as warning stickers and tags legible.
- Do not use the tool for applications it was not designed for.
- Tool repair should be performed by experienced personnel only.
- Make certain that the recommended relief valves are installed in the pressure side of the system.
- Do not use the tool for applications for which it was not intended.

# TROUBLESHOOTING

If symptoms of poor performance develop, the following chart can be used as a guide to correct the problem.

When diagnosing faults in operation, always make sure the hydraulic power source is supplying the correct hydraulic flow and pressure as listed in the table. Use a flowmeter know to be accurate. Check the flow with the hydraulic fluid temperature at least 80 °F/27 °C.

PROBLEM	CAUSE	SOLUTION
Pump will not start.	No hydraulic fluid flow or pressure.	Turn on power unit and check that 7–12 gpm/26–45 lpm at 1000-2000 psi/70–140 bar is available at the pump.
	Defective couplers.	Check the couplers. Replace if necessary.
	Impeller jammed with debris.	Clean the pumping chamber as described in the Maintenance section in this manual.
	Impeller rubbing against wear plates.	Check and adjust the impeller clearance as described in the Service Manual.
	Defective hydraulic motor.	Repair or replace motor.
Poor pump performance.	Hydraulic flow reversed.	Check that the hoses are correctly connected to the pump motor ports. The female coupler should be connected to the “IN” port. The return fluid must never flow through a reversing valve.
	Improper hydraulic fluid flow.	Check that 7–12 gpm/26-45 lpm at 1000–2000 psi/70–140 bar is available at the trash pump. A 20% decrease in flow can result in a 50% decrease in pump performance.
	Pump submersed in sediment.	Lift the pump from the bottom of the hole or chamber. Use a flat support under the pump if necessary.
	Trash pump inlet restricted.	Remove suction screen and thoroughly clean. Reassemble.
	Discharge hose kinked or restricted.	Straighten the hose. If the hose must bend at the top of the hole, use a piece of split rigid conduit with large diameter of the expanded hose. This keeps the hose from kinking.
	Discharge hose too small.	Use a 3-inch diameter fire hose.
	Water lift too high.	Lower the outlet end of the discharge hose. Increase hydraulic flow (12 gpm/45 lpm max).
	Impeller worn or damaged.	Check impeller for damage and excessive wear. Replace if necessary.
	Pump not matched to application	Obtain higher capacity pump.
	Hose used on suction side of pump.	Remove. Use no plumbing on suction side of pump.
Poor pump performance with excessive wear.	Too many solids in the water. Water speed out of the hose may be too slow, therefore hose and pump load up with solids.	Reduce solids content. Increase pump speed.

# SPECIFICATIONS

Capacity.....	500 gpm/1890 lpm
Weight .....	21 lbs/9.5 kg
Length.....	10.5 in./26.7 cm
Width .....	10 in./25.4 cm
Pressure .....	1000-2000 psi/70–140 bar
Flow Range .....	7–12 gpm/26–45 lpm
Maximum Flow .....	12 gpm/45 lpm
Porting .....	–8SAE O-ring
Connect Size and Type .....	3/8 in. Flush Face Quick Disconnect Couplers
Discharge Diameter.....	3 in./7.6 cm
Sound Pressure.....	<85 dBA @ 1 m

## ACCESSORIES

Description	Part No.
Adapter, 3 in. NPT/3 in. Camlock Male.....	52720
Lay-Flat Discharge Hose, 3 in. × 25 ft with Camlock Fittings .....	56761
Adapter, 3 in. Female Camlock × Male Fire Hose (nh) Thread .....	15248

# SM50 PARTS ILLUSTRATION

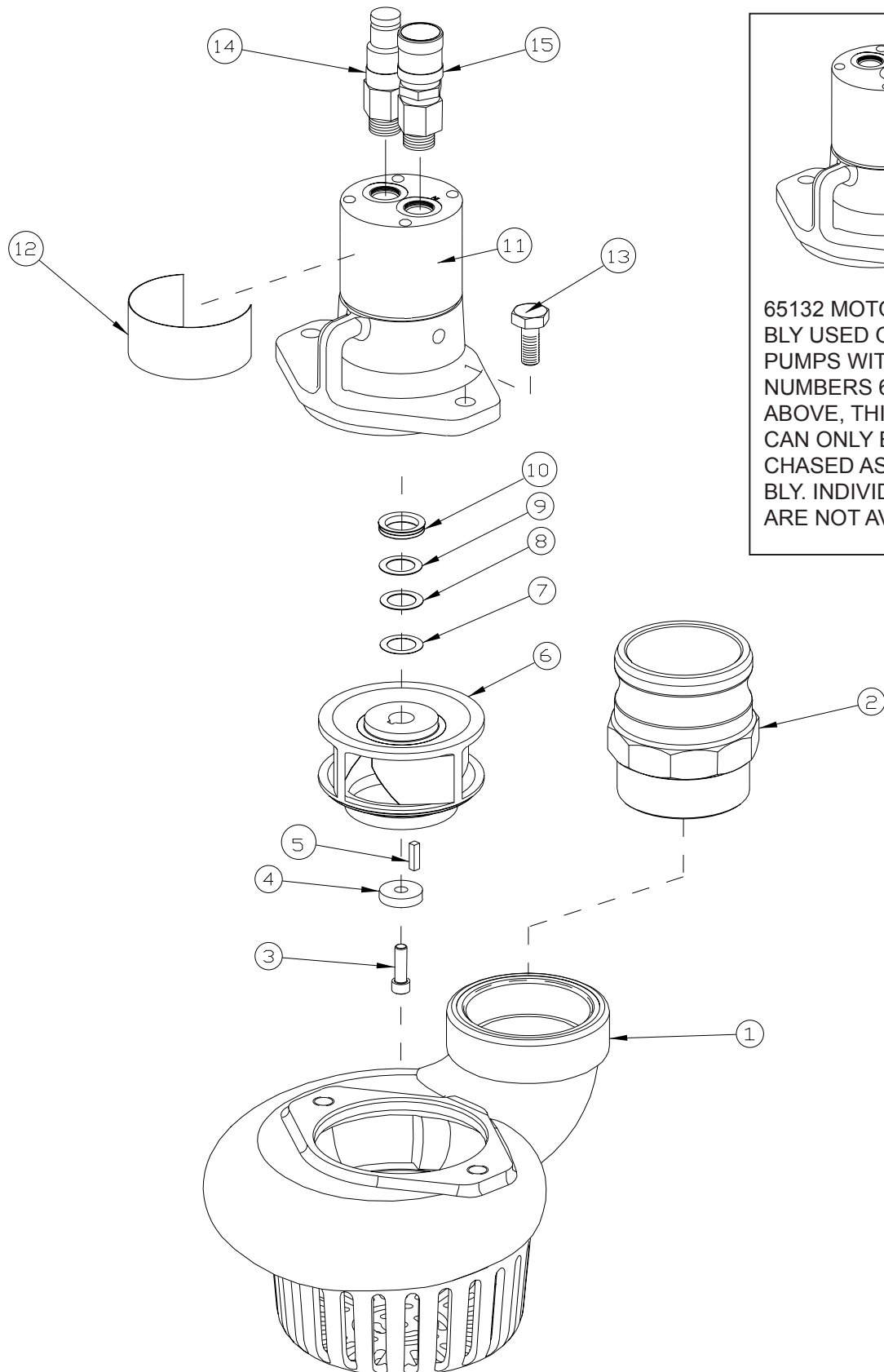

65132 MOTOR ASSEMBLY USED ON SUMP PUMPS WITH SERIAL NUMBERS 600 AND ABOVE, THIS MOTOR CAN ONLY BE PURCHASED AS AN ASSEMBLY. INDIVIDUAL PARTS ARE NOT AVAILABLE.

# SM50 PARTS LIST

ITEM NO.	PART NO.	QTY	DESCRIPTION
1	52669	1	VOLUTE
2	52720	1	CAMLOCK COUPLING 3 IN.
3	13815	1	HSCHS 5/16 – 18 × 3/4
4	56763	1	WASHER
5	00635	1	KEY
6	52671	1	IMPELLER
7	31032	1*	SHIM .020 (* NOTE QTY WHEN DISASSEMBLING TOOL)
8	31033	1*	SHIM .010 (* NOTE QTY WHEN DISASSEMBLING TOOL)
9	31034	1*	SHIM .005 (* NOTE QTY WHEN DISASSEMBLING TOOL)
10	52716	1	V-RING
11	65132	1	MOTOR ASSEMBLY
12	52728	1	SM50 COMBINED STICKER
13	52718	2	HHCS M12-1.75 X 30MM
14	58857	1	MALE FLUSH FACE COUPLER NOSE 3/8 NPT
15	58856	1	FEMALE FLUSH FACE COUPLER BODY 3/8 NPT
	58718	1	COUPLER SET (MALE & FEMALE)
	52758	1	REPAIR KIT
	66398	1	SEAL KIT FOR 65132 MOTOR (SERIAL # 600 AND ABOVE)

**NOTE:**

ALL SM50 PUMPS WITH A SERIAL NUMBER OF 600 AND ABOVE, COME SHIPPED WITH P/N 65132 MOTOR ASSEMBLY INSTALLED. A SEPARATE SEAL KIT 66398 IS AVAILABLE FOR THIS MOTOR.

IF YOU HAVE A SM50 WITH SERIAL # 599 AND BELOW CONTACT STANLEY CUSTOMER SERVICE FOR PARTS.



# UNDERWATER TOOLS DEPTH GUIDELINE

## UNDERWATER MODELS ONLY

### **⚠ CAUTION**

**DO NOT USE HYDRAULIC TOOLS UNDERWATER THAT ARE NOT DESIGNATED AS AN “UNDERWATER” MODEL, OR THIS WILL RESULT IN DAMAGE TO THE TOOL.**

For underwater hydraulic tools the applications are broken down into four quadrants depending on type of tool and method of operation.

The types of tools are percussive and rotational, each with different characteristics allowing for different depth operation. With percussive tools, the nitrogen accumulator PSI must counter the increase in ambient pressure found at lower depths. Since there is a maximum PSI for percussive tools they are limited to certain depths. Rotational tools do not have accumulators and thus capable of deeper depths.

The methods are broken into diver operated or remote operated vehicle (ROV). ROV's can reach lower depths and with an on-board hydraulic power source that is depth compensated, can operate hydraulic tools at depths of thousands of feet. ROV operation is still limited to the tool, for example a percussive tool has the same depth limitation whether ROV or diver operated.



## Operation Overview

	Percussive	Rotational
Diver	Tools: Breakers, Hammer Drills and Chipping Hammers  Max Depth: 500' - limitations due to accumulator PSI max (increase 40 PSI for every 100')	Tools: Grinders, Saws, Chain Saws  Max Depth: 1000' - Reference hose sizing guide below
ROV	Tools: Breakers, Hammer Drills and Chipping Hammers  Max Depth: 500' - limitations due to accumulator PSI max (increase 40 PSI for every 100')	Tools: Grinders, Saws, Chain Saws  Max Depth: 1000' - Reference hose sizing guide below

## Recommended Hose Diameters

Depth (ft)	8 GPM	12 GPM
100	5/8"	5/8"
300	3/4"	1"
600	1"	1"
1000	1"	1-1/4"



# STANLEY®

Stanley Hydraulic Tools  
3810 SE Naef Road  
Milwaukie, Oregon 97267-5698 USA  
(503) 659-5660 / Fax (503) 652-1780  
[www.stanleyhydraulics.com](http://www.stanleyhydraulics.com)

## Free Manuals Download Website

<http://myh66.com>

<http://usermanuals.us>

<http://www.somanuals.com>

<http://www.4manuals.cc>

<http://www.manual-lib.com>

<http://www.404manual.com>

<http://www.luxmanual.com>

<http://aubethermostatmanual.com>

Golf course search by state

<http://golfingnear.com>

Email search by domain

<http://emailbydomain.com>

Auto manuals search

<http://auto.somanuals.com>

TV manuals search

<http://tv.somanuals.com>