

Dot Matrix Printer

SP300 Series

Programmer's Manual



TABLE OF CONTENTS

1. CONTROL PANEL	1
1-1. Basic Operation	1
1-2. Switch Operation (Combined Switch Operation)	2
2. SERIAL INTERFACE	7
2-1. Interface Specifications	7
2-2. Interface Circuit	8
2-2-1. RS-232C Serial Interface	8
2-2-2. Current Loop (option)	8
2-2-3. RS-422A Serial Interface (option)	9
2-3. Connectors and Signals	10
2-4. Interface Connections	12
2-5. Installing the Optional Interface Board	13
2-6. Data Structure	14
2-6-1. DTR mode	14
2-6-2. X-ON/X-OFF mode	16
2-6-3. STX-ETX mode	19
3. PARALLEL INTERFACE	22
3-1. Interface Specifications	22
3-2. Interface Timing	22
3-3. Connectors and Signals	24
4. Emergency Suspension	25
5. VALIDATION PRINTING (Models with validation function only) .	26
5-1. Operating Method	26
5-2. Printing Format	27
5-3. Data format	27
5-4. Other	27
6. AUTO CUTTER (Auto-cutting models only)	28
6-1. Cutting Method	28
6-2. Cutting position	28
6-3. Auto cutting control codes	28
6-4. Other position to be observed	28

7. CONTROL CODES	29
7-1. Control Codes Used for Character Setting	32
7-2. Control Codes Used for Line Spacing	36
7-3. Control Codes Used for Page Layout.....	37
7-4. Control Codes Used for Graphics Printing	41
7-5. Control Codes Used for Download Characters	46
7-6. Control Codes Used for Peripheral Units.....	49
7-7. Other Control Codes	50
8. CHARACTER CODE TABLES	55
8.1 U.S.A. & Europe (DIP SW2-1: ON, SW2-2: ON).....	55
8.2 IBM Character Set #1 (DIP SW2-1: OFF, SW2-2: ON)	57
8.3 IBM Character Set #2 (DIP SW2-1: ON, SW2-2: OFF)	59
8.4 JAPAN (DIP SW2-1:, OFF, SW2-2: OFF)	61
8.5 International Character Sets	63

- For DIP switch settings, refer to Installation Manual.
- Models with validation function: SP312F, SP317F

1. CONTROL PANEL

1-1. Basic Operation

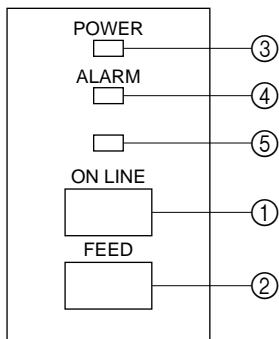

Fig. 1-1 Control panel

- ① “ON LINE” switch
Switches the printer between “ON LINE” and “OFF LINE”. Whenever the printer switches between “ON LINE” and “OFF LINE”, the buzzer gives one short beep (“ON LINE” and “OFF LINE”, switching is possible only when the paper is loaded in the printer.)
- ② “FEED” switch
- When this switch is pressed and then released within 0.5 sec., the paper feeds one line.
 - When this switch is depressed for more than 0.5 sec., the paper feeds continuously.
(The above paper feed operation is possible for both “ON LINE” and “OFF LINE” modes.)

- ③ “POWER” lamp (green LED)
- Lights when the power for the printer is on.
- ④ “ALARM” lamp (red LED)
- Lights when the paper is out.
If the paper is out, load a new roll then press the “ON LINE” switch.
 - Flashes when the front cover is open or a mechanical error (motor lock etc.) occurs. The buzzer will give one short beep followed by a long beep. Mount the front cover properly and press the “ON LINE” switch. If the buzzer still sounds and the “ALARM” lamp flashes, this signifies that a mechanical error has occurred. Locate the cause of the error and turn the power for the printer off and back on again to reset the printer.
(In case of a mechanical error, the data will not be cleared even if the power is turned off.)
- ⑤ “ON LINE” lamp (green LED)
- LED lit: Printer is ON LINE
LED off: Printer is OFF LINE
LED flashes: Validation printing mode is set.
- When all lamps ③ to ⑤ light simultaneously and the buzzer sounds continuously, a CPU error has occurred. In case of a CPU error, turn off the power then turn it on again. When turning off the power, the data will be cleared.

② <Hexadecimal dump mode>

ON LINE + **POWER ON** (Turn the power on while holding the **ON LINE** switch depressed.)

Each of the signals sent from the computer to the printer will be printed out in hexadecimal code.

This function allows you to check if a control code sent to the printer by the program being used is correct or not. The buzzer will sound once to indicate the printer is in hexadecimal dump mode.

After the program has been run, the last line buffer should be flushed by pressing the **ON LINE** switch. To turn off the mode, it is necessary to turn off the printer completely.

```
00 01 02 03 04 05 06 07      .....
08 09 0A 0B 0C 0D 0E 0F      .....
10 11 12 13 14 15 16 17      .....
18 19 1A 1B 1C 1D 1E 1F      .....
20 21 22 23 24 25 26 27      !"#$/&'
28 29 2A 2B 2C 2D 2E 2F      ()*+,-./
30 31 32 33 34 35 36 37      01234567
38 39 3A 3B 3C 3D 3E 3F      89:;<.
```

Fig. 1-3 Hexadecimal printing sample

③ <CLEAR PRINT BUFFER> (Single Head Only)

FEED + **ON LINE** + **POWER ON** (Turn the power on while holding both the **FEED** and **ON LINE** switches depressed.)

This operation clears the printer buffer. (The buzzer gives two short beeps.)

When DIP switch 1-7 of this printer is set to ON (which is the factory presetting), the RAM back-up function operates to maintain the data in the data buffer, even if the power for the printer is shut off due to power failure, etc.

However, when the printer power is shut off for more than 10 hours, the data content will become unstable and its content could degenerate and become unusable in the worst instances. For this reason, when the printer power is turned off for more than 10 hours, perform the above operation to clear the data in the data buffer.

Note that the data in the buffer can also be cleared by control code <CAN>.

④ <MICRO FEED>

ON LINE + **FEED** Press the **FEED** switch while holding the **ON LINE** switch depressed when the printer is OFF LINE and the paper will feed in very small increments.

⑤ <PAGE TOP> (Sprocket-type Only)

ON LINE + **FEED** (Press the **FEED** button while holding the **ON LINE** button depressed when the printer is ON LINE) The buzzer gives three short beeps and the printer sets the page top.

⑥ <Dot alignment adjust mode> (Twin Head Only)

FEED + **ON LINE** + **POWER ON**

This mode enables adjustment of the forward and backward printed line alignment by 1/2-dot increments. The adjustment procedure is explained on the following pages.

2. SERIAL INTERFACE

2-1. Interface Specifications

- ① Data transmission method: Asynchronous serial interface
- ② Baud rate: Selectable from 150, 300, 600, 1200, 2400, 4800, 9600, 19200 (Twin Head only) bps (Refer to Installation Manual.)
- ③ Word length
Start bit: 1 bit
Data bit: 7 or 8 bits (selectable. Refer to Installation Manual.)
Parity bit: Odd, even or none (selectable. Refer to Installation Manual.)
Stop bit: 1 or 2 bit length
- ④ Signal polarity
RS-232C (Standard feature)
MARK : Logic "1" (-3V to -25V)
SPACE : Logic "0" (+3V to +25V)
Current loop (optional)
MARK : Logic "1" (current ON)
SPACE : Logic "0" (current OFF)
RS-422A (Optional)
MARK : Logic "1"
A is -0.2V or less than B
SPACE : Logic "0"
A is 0.2V or more than B

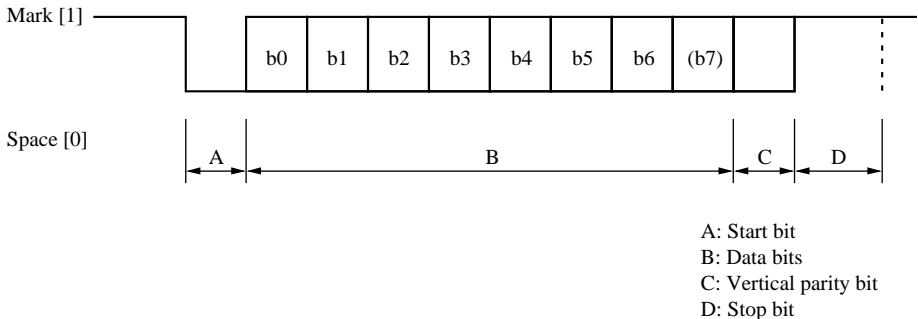

2-2. Interface Circuit

2-2-1. RS-232C Serial Interface

Input (RXD, CTS)

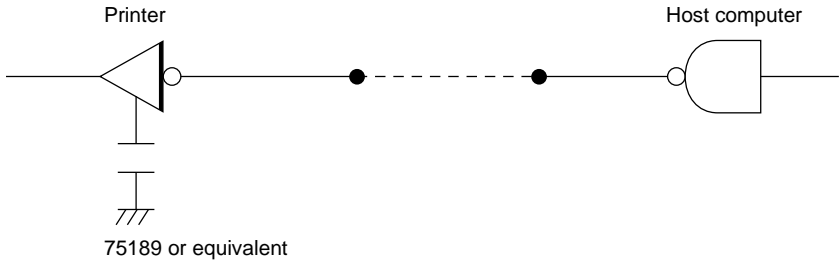

Output (DTR, FAULT, TXD, RCH, RTS)

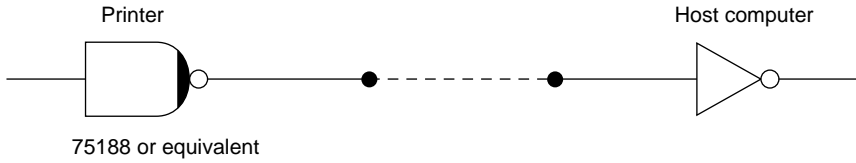
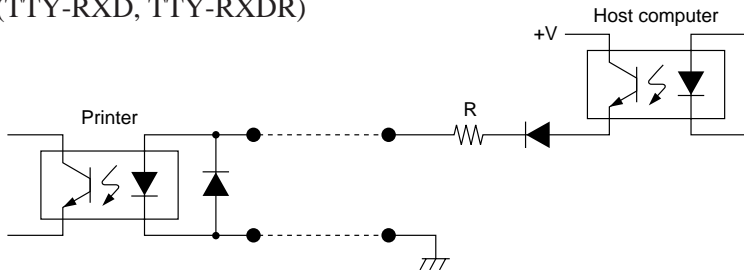

Fig . 2-1 RS-232C interface circuit

2-2-2. Current Loop (option)

Input (TTY-RXD, TTY-RXDR)



Output (TTY-TXD, TTY-TXDR)

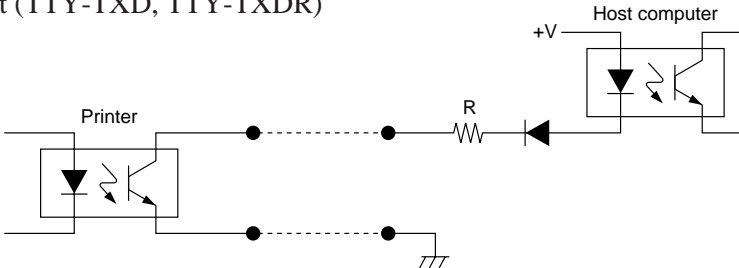

Note: Adjust “R” so that the loop current is set within 10 to 20 mA.

Fig. 2-2 Current loop interface circuit

2-2-3. RS-422A Serial Interface (option)

Input (RD, RS)



Output (SD, CS)

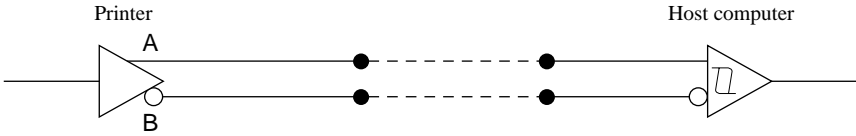

Fig. 2-3 RS-422A interface circuit

2-3. Connectors and Signals

RS-232C

Pin no.	Signal name	I/O direction	Function
1	F-GND	—	Frame ground
2	TXD	OUT	Transmitted data
3	RXD	IN	Received data
4	RTS	OUT	Data transmission request signal. This is always “SPACE” when the printer is turned on.
5	CTS	IN	This signal changes to “SPACE” when host computer is ready to transmit data. (In this instance, the printer does not check this signal.)
6	N/C		Not connected
7	S-GND	—	Signal ground
8	N/C		Not connected
9-10	N/C		This pin is used when using the optional interface board.
11	RCH	OUT	This signal changes to “SPACE” when the printer is ready to receive data. (The signal line is same as pin 20.)
12	N/C		Not connected.
13	S-GND	—	Signal ground
14	$\overline{\text{FAULT}}$	OUT	When printer error occurs (such as paper out, mechanical error, etc.), this signal is set to “MARK”.
15	Multi-printer TXD	OUT	Diode coupled TXD
16	Multi-printer DTR	OUT	Diode coupled DTR
17 to 19	N/C		This pin is used when using the optional interface board.
20	DTR	OUT	Data terminal ready signal. When the printer is ready to receive data, this signal changes to “SPACE”.
21-22	N/C		Not connected
23 to 25	N/C		This pin is used when using the optional interface board.

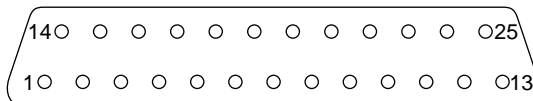

Fig. 2-4 Serial interface connector

20 mA current loop (option)

Pin no.	Signal name	I/O direction	Function
9	TTY TXDR	—	Indicates the ground side of the data signal of 20 mA loop current.
10	TTY TXD	OUT	Transmitted data of 20 mA current loop.
17	TTY TXDR	—	Indicates the ground side of the data signal of 20 mA loop current.
18	TTY RXDR	—	Indicates the ground side of the data signal of 20 mA loop current.
19	TTY RXD	IN	Received data of 20 mA current loop.
23	TTY RXDR	—	Indicates the ground side of the data signal at 20 mA loop current.
24	TTY TXD	OUT	Transmission data of 20 mA current loop.
25	TTY RXD	IN	Reception data of 20 mA current loop.

RS-422A (option)

Pin no.	Signal name	I/O direction	Function
9	SD (+)	OUT	Transmitted data
10	SD (-)	OUT	Transmitted data
17	RD (+)	IN	Received data
18	RD (-)	IN	Received data
19	CS (+)	IN	When the host computer is set to standby for data transmission, this signal changes to “SPACE”. (In this instance, the printer does not check the signal.)
23	CS (-)	IN	When the host computer is set to standby for data transmission, this signal changes to “SPACE”. (In this instance, the printer does not check the signal.)
24	RS (+)	OUT	Data transmission request signal. When the printer is ready to receive data, this signal changes to “SPACE”.
25	RS (-)	OUT	Data transmission request signal. When the printer is ready to receive data, this signal changes to “SPACE”.

2-4. Interface Connections

The following is a basic example of interface connections. (For interface connections, refer to the specifications for the respective interface.) IBM PC type serial port is shown as example.

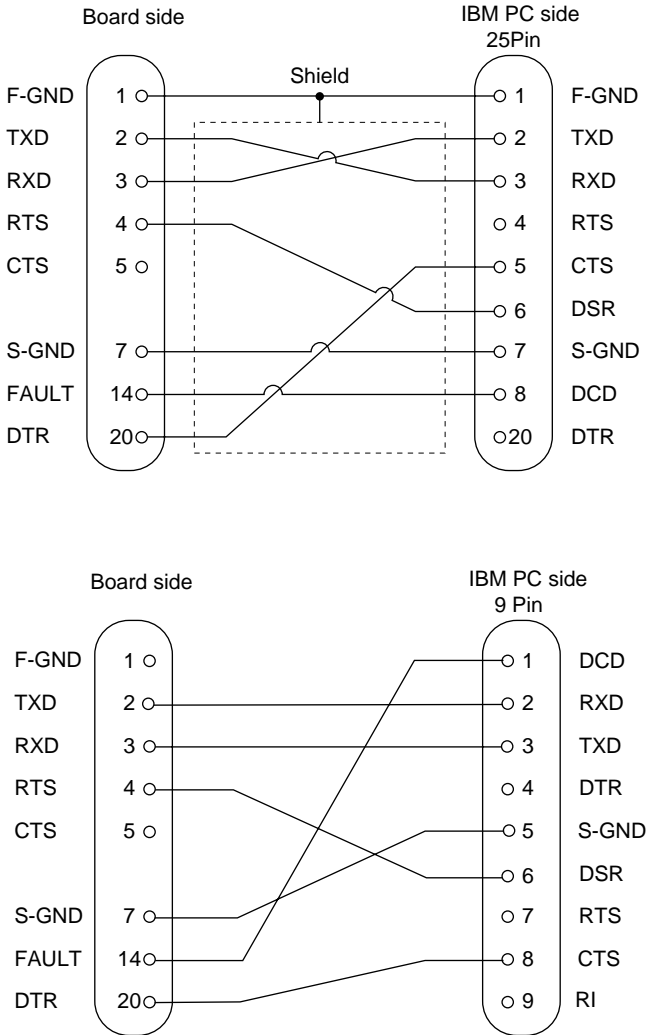

Fig. 2-5 Example of interface connections for IBM PC

2-5. Installing the Optional Interface Board

When using the optional 20 mA current loop interface or the RS-422A interface, the optional interface board must be mounted to the printer's main logic board. The following is the method of mounting the interface board to the printer's main logic board.

- ① Remove the 6 screws on the bottom cover of the printer, then remove the bottom cover.
- ② Connect the optional interface board connector to connector CN9 on the printer's main logic board.
- ③ At the same time, insert the plastic board support of the main logic board into the hole on the interface board.
- ④ Switch SW5 and SW6 on the main logic board from A-C to B-C.
- ⑤ Mount the bottom cover to the printer and fasten the 6 screws to fix it in place on the printer.

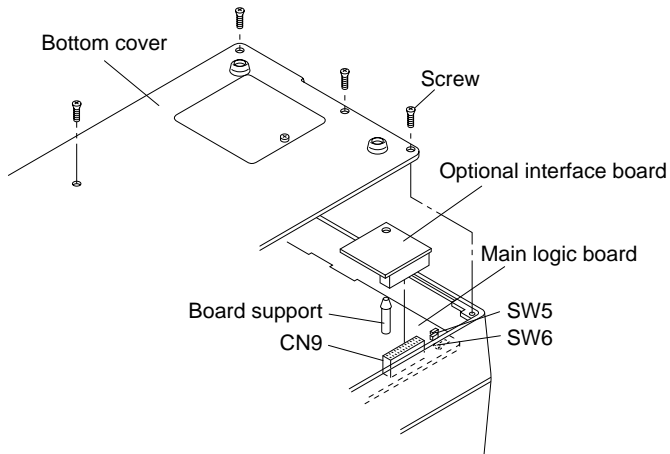

Fig. 2-6 Installing the optional interface board

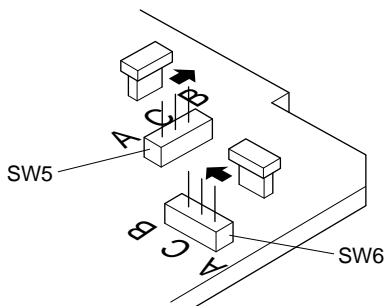
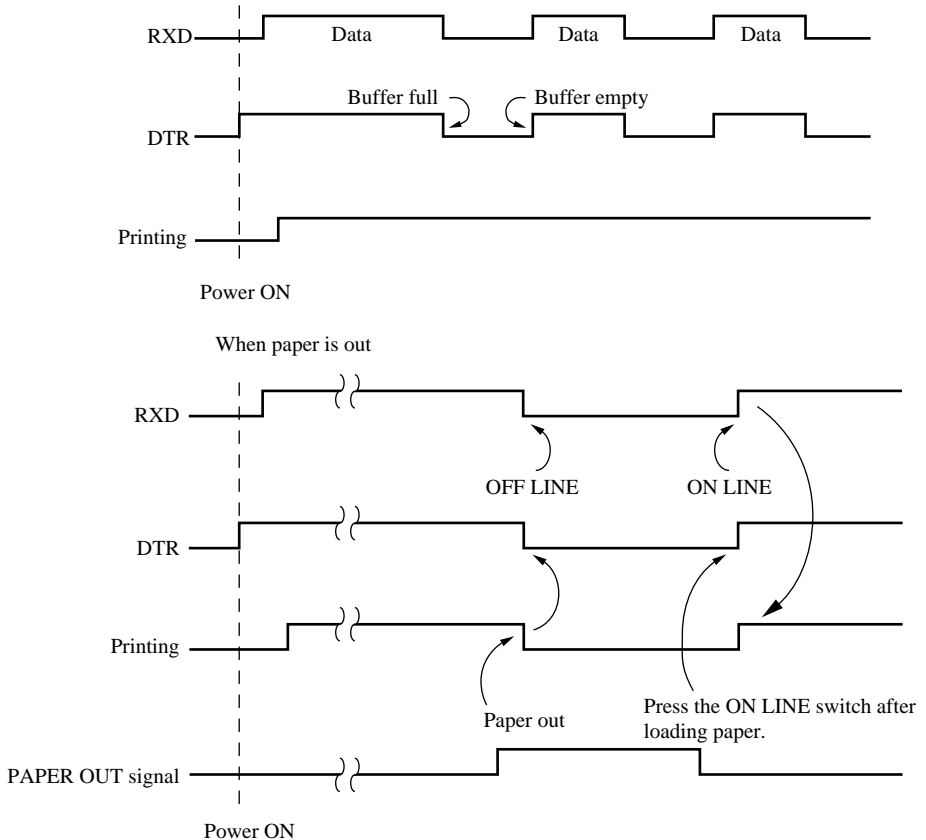

Fig. 2-7 Switch SW5 and SW6

2-6. Data Structure

2-6-1. DTR mode

This mode is accessed when the DIP switch 3-5 is ON.
Signals are controlled using the DTR line as BUSY flag.



If a printer errors do not occur after the power is turned on, the DTR signal line changes to “SPACE”.

When the host computer confirms that the DTR signal line is set to “SPACE”, the host computer sends the data text via the RXD signal line to the printer. Also, the printer will set the DTR signal line to “MARK” when the empty space in the data buffer is below 256 bytes. After the host computer detects that the DTR signal line is at “MARK”, transmission of the data text is stopped. In this instance, data can still be received up until the data buffer becomes completely full.

When the empty space in the data buffer is increased following printing (when the data in the data buffer is reduced to 256 bytes or less), the printer sets the DTR signal line to “SPACE”.

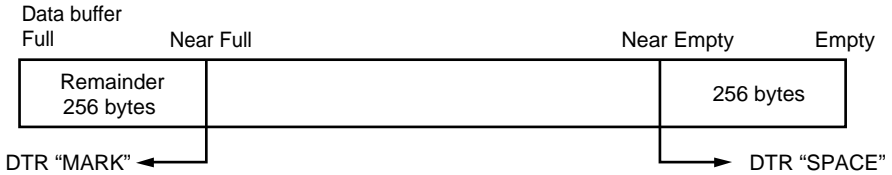

[Paper out]

When the "paper out" detector senses the end of the paper, the printer stops printing after printing a maximum of two more lines or on feeding the paper. Immediately after a "paper out" condition is detected, the printer sets to OFF LINE and the DTR changes to "MARK". (To reset printer after a "paper out", load paper into the printer and press the ON LINE switch to set the printer to ON LINE.)

[Mechanical error]

Mechanical errors are detected when the front cover is opened during printing, or when the motor locks and the unit will not print. Immediately after a mechanical error occurs, the printer sets the DTR to "MARK" and then sets the printer to OFF LINE. To cancel a mechanical error, close the front cover properly and press the ON LINE switch. If the buzzer sounds and the ALARM lamp flashes at this time, then locate the cause of the error and turn the power for the printer off and back on again to reset the printer.

[Status]

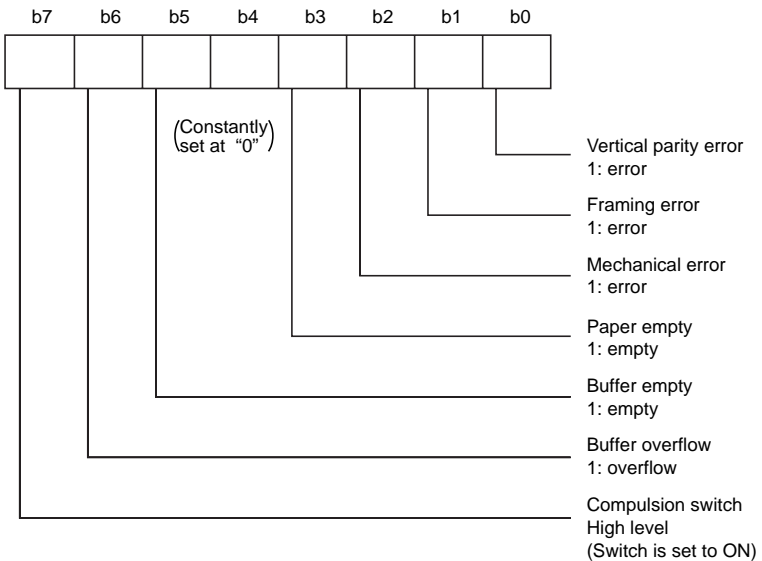

[Framing error]

A framing error occurs when SPACE is detected at the stop bit. When a framing error or a vertical parity error occurs for the data which is received, the printer prints out a “?” mark to indicate that the error occurred.

[Compulsion switch]

When pin 6 of the peripheral unit drive circuit connector is set “HIGH”, status bit 7 becomes “1”.

2-6-2. X-ON/X-OFF mode

This mode accessed when the DIP switch 3-5 is OFF.

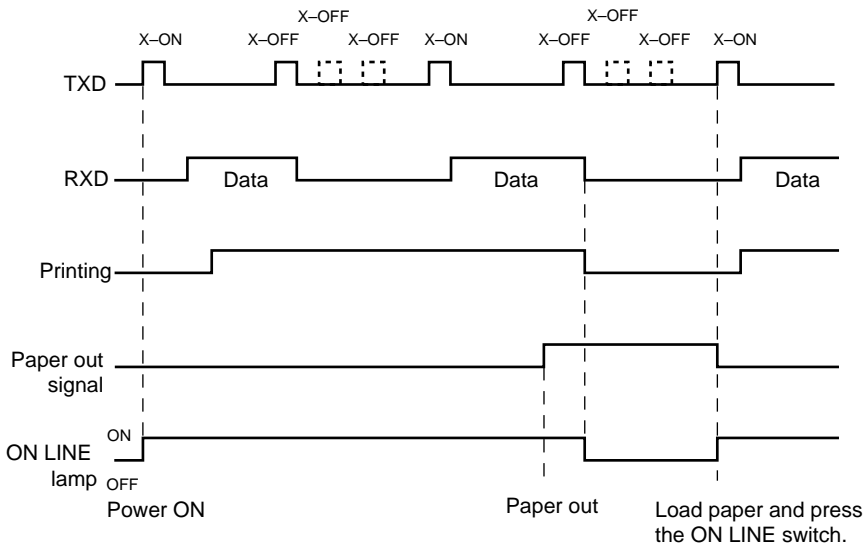

If printer errors do not occur after the power is turned on, the printer outputs an X-ON (DC1 by control code; 11H by hexadecimal data) signal on the TXD signal line which sends it to the host computer. When the host computer receives the X-ON signal, the host computer transmits the data to the RXD signal line for the printer. If data text is not sent from the host computer (even after transmitting the X-ON signal to the host computer), the printer outputs an X-ON signal at 3 second intervals until the printer receives data.

The printer starts outputting an X-OFF (DC3, 13H) signal when the empty space in the buffer reduces below 256 bytes. When the host computer receives the X-OFF signal, it halts output of data. (however, the printer can continue receiving data until the buffer becomes completely full.)

Output of the X-ON signal is resumed when the data in the buffer is printed out and drops to below 256 bytes.

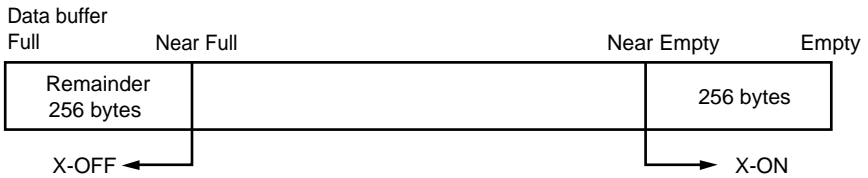

[Paper out]

When the “paper out” detector senses the end of the paper, the printer stops printing after printing a maximum of two more lines or on feeding the paper. The printer will set the DTR to “MARK” and set the printer to OFF LINE five seconds after a “paper out” condition is detected. To reset the printer after a “paper out”, load a new roll of paper into the printer and press the OFF LINE switch to set the printer ON LINE.

[Mechanical error]

Mechanical errors occur when the front cover is opened during printing and printing stops or when the motor locks and printing stops. After the error occurs, the printer outputs an X-OFF signal and stops printing. The printer sets the DTR signal to “MARK” and sets to OFF LINE five seconds after a mechanical error occurs. To reset the printer after a mechanical error occurs, close the front cover properly and press the ON LINE switch. If a buzzer sounds and the ALARM lamp flashes at this point, locate the cause of the error and turn the power off and then back on to reset the printer.

[Status]

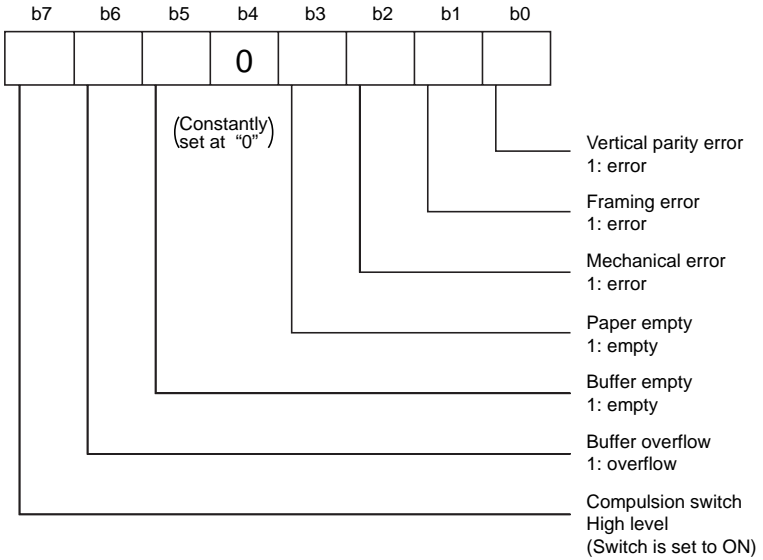

[Framing error]

A framing error occurs when SPACE is detected at the stop bit. When a framing error or a vertical parity error occurs for the data which is received, the printer prints out a “?” mark to indicate that the error occurred.

[Compulsion switch]

When pin 6 of the peripheral unit drive circuit connector is set at “HIGH”, status bit 7 becomes “1”.

2-6-3. STX-ETX mode

This mode is accessed from whichever DTR mode or X-ON/X-OFF mode. To set this mode, the data buffer must be empty.

The host computer sends an ENQ code to the printer and acknowledges the printer status. Then, the host computer checks if the printer buffer is empty. After the host computer detects that the buffer is empty, a STX code and data are transmitted. After 1 block of data is transmitted, the host computer sends an ENQ code to the printer and then receives the printer status and check byte (horizontal parity for the printer.)

At this points, the host computer performs a status and horizontal parity check. When the host computer determines that there was no error, it transmits an ETX code which serves as text end code. After the printer receives the ETX code, data in the data buffer is printed out. If an error occurs, a CAN code is transmitted by the host computer. (In this instance, the data which was previously sent to the buffer is cleared, thus, the host computer must retransmit the same data to the printer.)

A flowchart of this operation is illustrated on the following page.

[Status]

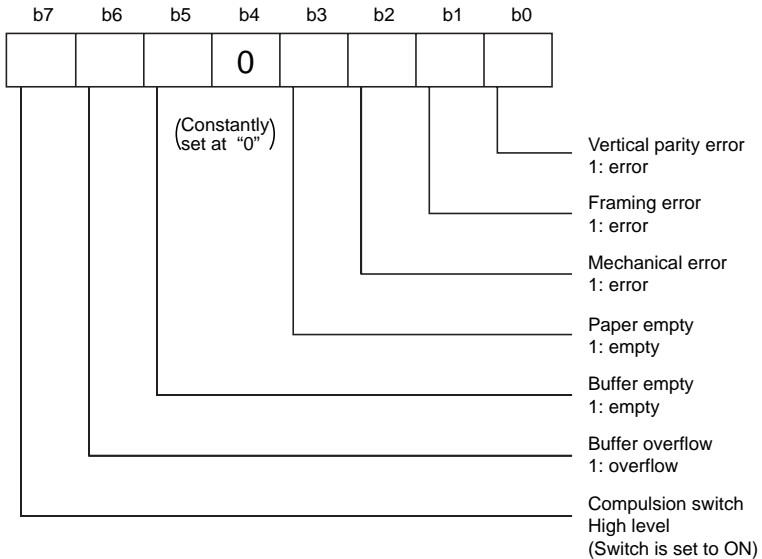

[Framing error]

A framing error occurs when SPACE is detected at the stop bit. When a framing error or a vertical parity error occurs for the data which is received, the printer prints out a "?" mark to indicate that the error occurred.

[Compulsion switch]

When pin 6 of the peripheral unit drive circuit connector is set at “HIGH”, status bit 7 becomes “1”.

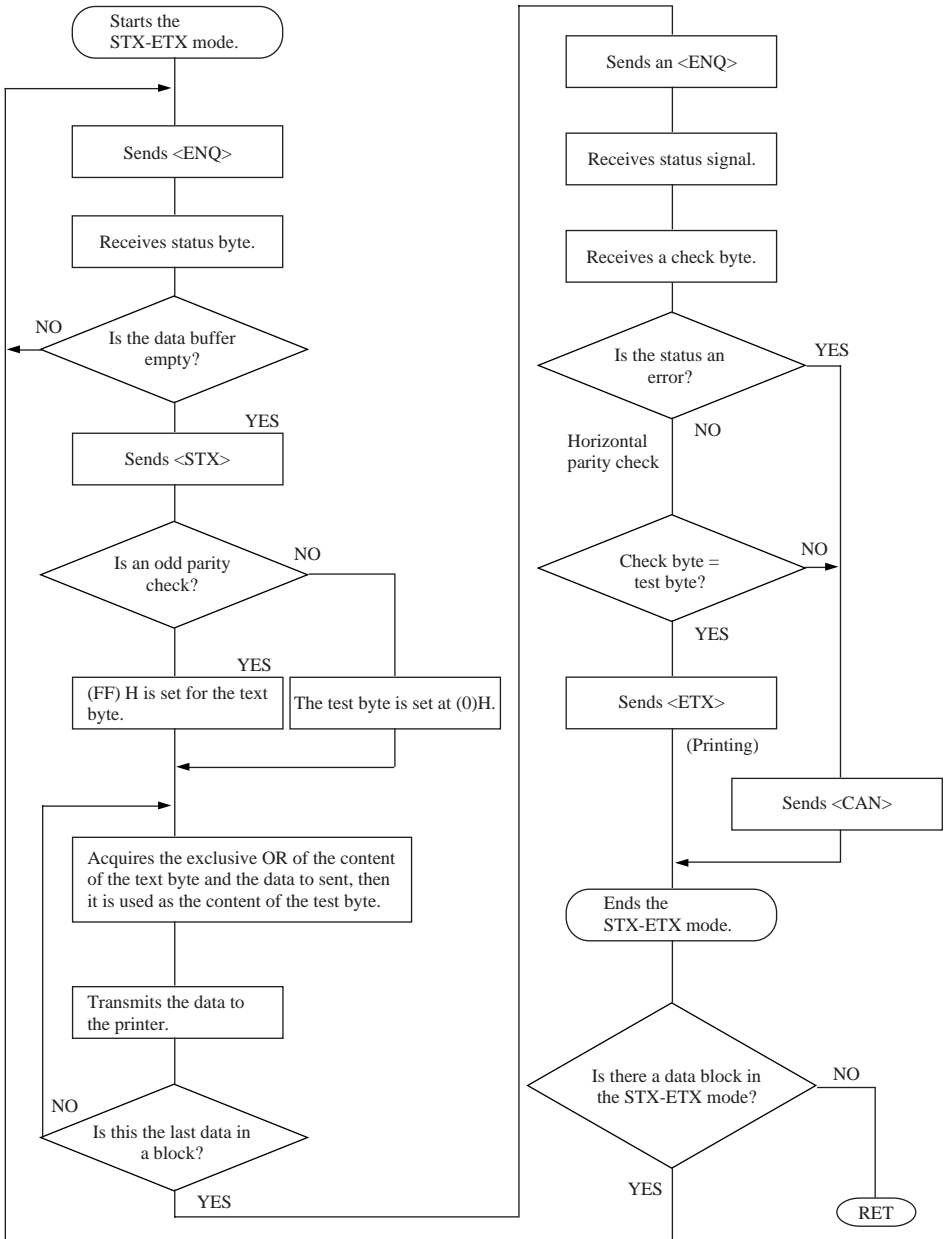

Check byte:
Horizontal parity of the printer.
Test byte:
Horizontal parity of the host computer.

STX-ETX mode flow diagram for host computer

3. PARALLEL INTERFACE

3-1. Interface Specifications

This printer has a parallel interface to communicate with the computer. The operating specifications of the parallel interface are as follows.

- (1) Data transfer rate : 1000 to 6000 characters per second
- (2) Synchronization : Via externally supplied $\overline{\text{STROBE}}$ pulses
- (3) Handshaking : $\overline{\text{ACK}}$ and BUSY signals
- (4) Logic level : Compatible with TTL level

3-2. Interface Timing

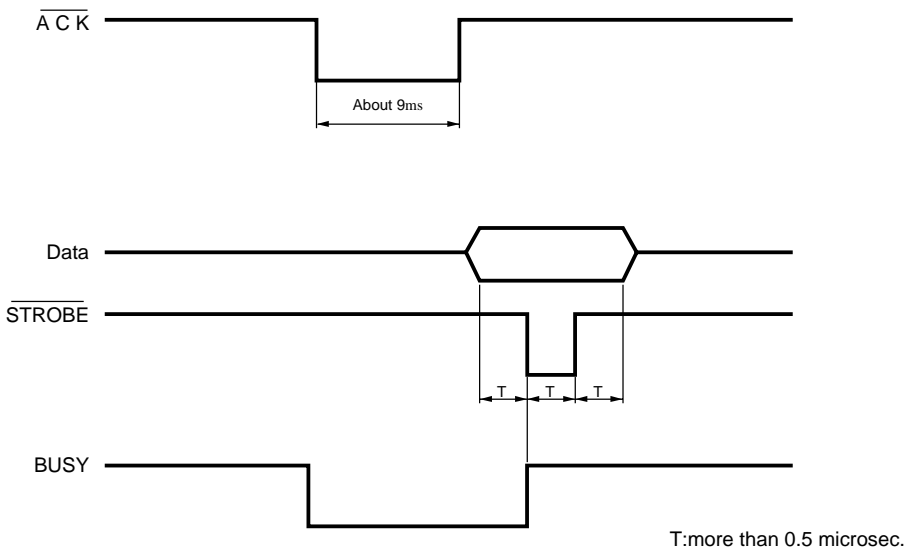

Fig. 3-1 Interface timing diagram

	Signal Name	Circuit Example
INPUT	DATA 1 – DATA 8 (To Printer)	<p>4.7KW 74 HC Compatible</p>
	$\overline{\text{STROBE}}$ (To Printer)	<p>4.7KW 74 HC Compatible</p>
OUTPUT	BUSY, $\overline{\text{ACK}}$ (From Printer)	<p>4.7KW 74 HC Compatible</p>

Fig. 3-2 Typical interface circuit

3-3. Connectors and Signals

Pin no	Signal name	Direction	Function
1	$\overline{\text{STROBE}}$	IN	Signals when data is ready to be read. Signal goes from HIGH to LOW (for at least 0.5 microsec.) when data is available.
2-9	DATA 1-8	IN	These signals provide the information of the first to eighth bits of parallel data. Each signal is at HIGH level for a logical 1 and at a LOW level for a logical 0.
10	$\overline{\text{ACK}}$	OUT	A 9 microsecond LOW pulse acknowledges receipt of data.
11	BUSY	OUT	When this signal goes LOW, the printer is ready to accept data. When the printer is in one of the conditions below. "HIGH" is set. 1. Data being entered. 2. Off line. 3. Error condition.
12	PAPER OUT	OUT	This signal is normally LOW. It will go HIGH if the printer runs out of paper.
13	SELECTED	OUT	This signal is HIGH when the printer is online.
14-15	N/C		Unused
16	SIGNAL GND		Signal ground.
17	CHASSIS GND		Chassis ground, isolated from logic ground.
18	+5VDC		+5VDC (Max 50mA)
19-30	$\overline{\text{GND}}$		Twisted pair return signal ground level.
31	$\overline{\text{RESET}}$	IN	When this signal goes LOW, the printer is reset to its power-on condition.
32	$\overline{\text{ERROR}}$	OUT	This signal is normally HIGH. This signal goes LOW to signal that the printer cannot print due to an error condition. Refer to Item 8-4 Emergency Suspension.
33	EXT GND		External ground.
34	COMPULSION	OUT	Compulsion signal
35-36	N/C		Unused.

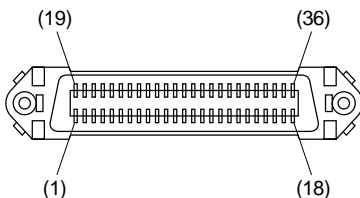

This connector mates with an Amphenol 57-30360 connector

Fig. 3-3 Parallel interface connector (printer side)

4. EMERGENCY SUSPENSION

If any of the following errors is detected while the printer is operating, the printer halts and ERROR signal turns to “LOW” level.

① Mechanical errors

- Motor lock
- Defective of timing detector (signal not issued)
- Abnormal home position check.
- Defective cutter movement (paper jam, etc.)
- Timing error of Reset sig of the auto cutter during the auto cutter operation (Auto-cutting models only)
- Abnormality of thermistor

To reset the emergency suspension, rectify the cause of trouble & adopt one of the following 2 methods.

- Turn the printer power off and on again.
- Push ON LINE switch.

Even while in the status of no backed up RAM with DIP SW1-7, the RAM is not cleared when power is turned OFF. Printing resumes from the line being printed when the mechanism stopped. (Single Head Only)

② If the front cover is opened while printing

If the front cover is opened while printing, the same operation as given in above item “① Mechanical errors” takes place. To restart printing, close the front cover and push ON LINE switch.

③ CPU error

If CPU goes erratic due to external noise, etc., the printer halts, treating it as CPU error. Normal operation can be resumed by turning ON the power supply again, but the data contained in RAM gets cleared.

④ RAM Check Function

Before self-printing and when clearing the buffer, a RAM check is performed.

⑤ Procedures at Time of Power Interruption (Single Head Only)

When using the backed up RAM function in valid status, the data in the buffer will be preserved even when there is a power interruption. When the power is turned ON again, the power interruption message “” will be printed, and printing will be resumed from the line where it was stopped.

5. VALIDATION PRINTING (Models with validation function only)

This printer can print one line of validation printing.

5-1. Operating Method

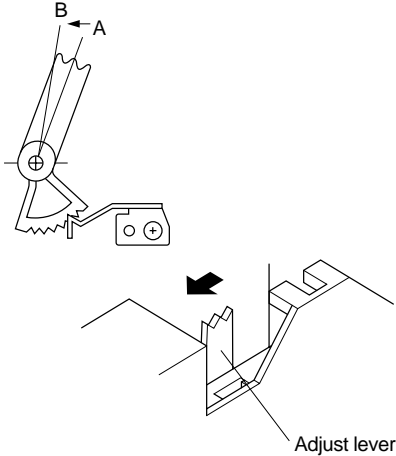

A: Standard position (one sheet)
B: Validation printing or copying

Fig. 5-1 Position of the adjust lever

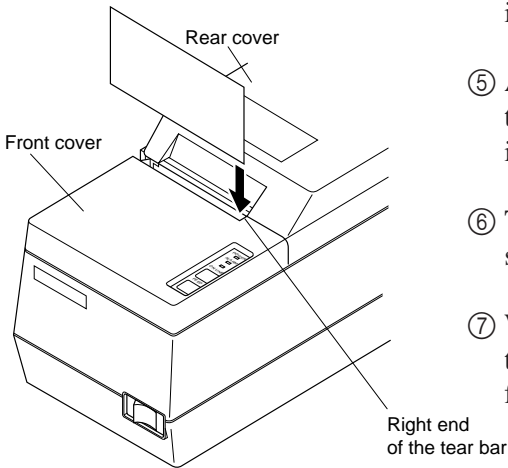

Fig. 5-2 Loading the paper

- ① Open the front cover, pull the adjust lever one notch from standard position A toward the operation panel side position B.
When you cannot find standard position A, push the lever as far as possible toward the rear cover, and pull it 2 notches after having pressed it down. The lever is now in standard position A.
- ② Mount the front cover.
- ③ Set the printer for the validation print mode. In this instance, the buzzer gives two short beeps.
- ④ Make sure that the ON LINE lamp is flashing.
- ⑤ Align the right edge of paper with the right end of the tear bar then insert the paper from the top.
- ⑥ The printer starts printing approx. 1 second after the paper is loaded.
- ⑦ When printing is completed, pull the paper upward and remove it from the printer.

Note: When printing a roll paper, also set the adjust lever at position B.

5-2. Printing Format

Prints one line in 7×9 font normal printing.

32 columns (from the 5th to 36th columns)

Even if the setting for the paper width is changed by the DIP switch, the 32-column format will not change.

5-3. Data format

<GS> <data> <LF>

5-4. Other

- The FEED and ONLINE switches will not operate normally during validation printing.
- When the printer receives an immediate execution command for peripheral units during validation printing, it executes the command when the validation print mode is canceled.
- Modes in effect before the validation printing (such as emphasized printing, inverted printing, expanded printing, and underlining) are invalid during validation printing. But these become valid again after validation printing.
- Data received before a <GS> code is printed out when the printer receives the <GS> code.

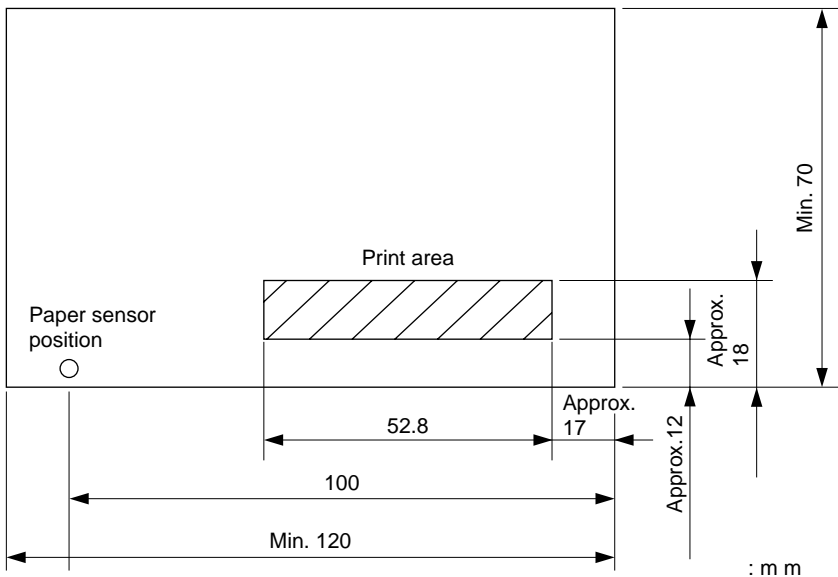

Fig. 5-3 Print area

6. AUTO CUTTER (Auto-cutting models only)

6-1. Cutting Method

Cuts recording paper into continuous forms connected at only one point remaining uncut between adjacent forms.

Only one sheet of paper can be cut each time.

6-2. Cutting position

The paper is cut approximately 21.7 mm above the printing head.

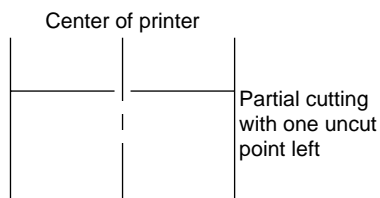

Fig. 6-1 Cutting method

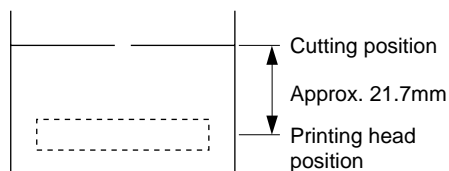

Fig. 6-2 Cutting position

6-3. Auto cutting control codes

<ESC> “d” “0” or <ESC> “d” <0>

<ESC> “d” “1” or <ESC> “d” <1>

Refer to the control codes of chapter 10.

6-4. Other position to be observed

- ① When continuously cutting for more than 12 minutes, make a maximum of 10 cuttings per minute.
- ② When using for a long time, paper dust will gather around the cutter. Therefore, make sure to clean periodically. If paper dust is not removed, normal paper feeding may become impossible.

7. CONTROL CODES

Control Codes Used for Character Setting

Control codes	Hexadecimal codes	Function	Page
<ESC> “R” <i>n</i>	1B 52 <i>n</i>	Select international character set	32
<ESC> “6”	1B 36	Select IBM character set #2	32
<ESC> “7”	1B 37	Select IBM character set #1	32
<ESC> “M”	1B 4D	Select 7 × 9 (half dot) font	33
<ESC> “P”	1B 50	Select 5 × 9 (2 pulses + 1 dot) font	33
<ESC> “.”	1B 3A	Select 5 × 9 (3 pulses + 1 dot) font	33
<SO>	0E	Select expanded character mode	33
<DC4>	14	Cancel expanded character mode	34
<ESC> “W” “1”	1B 57 31	Select expanded character mode	34
<ESC> “W” <1>	1B 57 31		
<ESC> “W” “0”	1B 57 30	Cancel expanded character mode	34
<ESC> “W” <0>	1B 57 30		
<ESC> “E”	1B 45	Select emphasized print mode	34
<ESC> “F”	1B 46	Cancel emphasized print mode	34
<ESC> “-” “1”	1B 2D 31	Select underline mode	35
<ESC> “-” <1>	1B 2D 01		
<ESC> “-” “0”	1B 2D 30	Cancel underline mode	35
<ESC> “-” <0>	1B 2D 00		
<ESC> “_” “1”	1B 5F 31	Select upperline mode	35
<ESC> “_” <1>	1B 5F 01		
<ESC> “_” “0”	1B 5F 30	Cancel upperline mode	35
<ESC> “_” <0>	1B 5F 00		
<ESC> “4”	1B 34	Select highlighted print mode	35
<ESC> “5”	1B 35	Cancel highlighted print mode	36
<SI>	0F	Select inverted print mode	36
<DC2>	12	Cancel inverted print mode	36

Control Codes Used for Line Spacing

Control codes	Hexadecimal codes	Function	Page
<LF>	0A	Line feed	36
<CR>	0D	Line feed (same as LF)	36
<ESC> “z” “1”	1B 7A 31	Set 1/6-inch line feed	36
<ESC> “z” <1>	1B 7A 01		
<ESC> “0”	1B 30	Set 1/8-inch line feed	37
<ESC> “a” <i>n</i>	1B 61 <i>n</i>	Feed paper <i>n</i> lines	37

Control Codes Used for Page Layout

Control codes	Hexadecimal codes	Function	Page
<FF>	0C	Page feed (form feed)	37
<ESC> “C” <i>n</i>	1B 43 <i>n</i>	Set page length at <i>n</i> lines	37
<ESC> “C” <0> <i>n</i>	1B 43 00 <i>n</i>	Set page length at <i>n</i> inches	37
<ESC> “B” <i>n1 n2</i>	1B 42 <i>n1 n2</i>	Set vertical tab positions	38
<VT>	0B	Execute vertical tab	38
<ESC> “N” <i>n</i>	1B 4E <i>n</i>	Set bottom margin	38
<ESC> “O”	1B 4F	Cancel bottom margin	39
<ESC> “I” <i>n</i>	1B 6C <i>n</i>	Set left margin	39
<ESC> “Q” <i>n</i>	1B 51 <i>n</i>	Set right margin	39
<ESC> “D” <i>n1 n2</i>	1B 44 <i>n1 n2</i>	Set horizontal tab position	40
<HT>	09	Execute the horizontal tab	40

Control Code Used for Graphics Printing

Control codes	Hexadecimal codes	Function	Page
<ESC> “I”	1B 31	Set 7/72-inch line feed	41
<ESC> “A” <i>n</i>	1B 41 <i>n</i>	Define <i>n</i> /72-inch line feed	41
<ESC> “2”	1B 32	Set <i>n</i> /72-inch line feed	41
<ESC> “J” <i>n</i>	1B 4A <i>n</i>	One time line feed of <i>n</i> /72-inch	41
<ESC> “z” “0”	1B 7A 30	Set 1/12-inch line feed	41
<ESC> “z” <0>	1B 7A 00		
<ESC> “3” <i>n</i>	1B 33 <i>n</i>	Set <i>n</i> /216-inch line feed simulation	42
<ESC> “y” <i>n</i>	1B 79 <i>n</i>	Set <i>n</i> /144-inch line feed (Models with 1/44” -pitch paper feed mechanism only)	42
<ESC> “K” <i>n1</i> <0>	1B 4B <i>n1</i> 00	8 dot single density bit image	42
<ESC> “L” <i>n1 n2</i>	1B 4C <i>n1 n2</i>	8 dot double density bit image	44
<ESC> “h” “1”	1B 68 31	Select vertical expanded character mode	45
<ESC> “h” <1>	1B 68 01		
<ESC> “h” “0”	1B 68 30	Cancel vertical expanded character mode	45
<ESC> “h” <0>	1B 68 00		

Control Codes Used for Download Characters

Control codes	Hexadecimal codes	Function	Page
<ESC> “&” <0> <i>n1 n2</i>	1B 26 00 <i>n1 n2</i>	Definition of down load characters	46
<ESC> “%” “1”	1B 25 31	Enable download character set	47
<ESC> “%” <1>	1B 25 01		
<ESC> “%” “0”	1B 25 30	Disable download character set	47
<ESC> “%” <0>	1B 25 00		

Control Codes Used for Peripheral Units

Control codes	Hexadecimal codes	Function	Page
<ESC> <BEL> <i>n1 n2</i>	1B 07 <i>n1 n2</i>	Adjust drive pulse width for peripheral unit 1	49
<BEL>	07	Deferred drive command for peripheral unit 1	49
<FS>	1C	Immediate drive command for peripheral unit 1	49
<SUB>	1A	Immediate drive command for peripheral unit 2	50
	19	Immediate drive command for peripheral unit 1	50

Other Control Codes

Control codes	Hexadecimal codes	Function	Page
<RS>	1E	Sound buzzer	50
<CAN>	18	Cancel print data in buffer & Initialize printer	50
<DC3>	13	Set deselect mode	51
<DC1>	11	Set select mode	51
<ESC> “U” “1”	1B 55 31	Select uni-directional print mode	52
<ESC> “U” <1>	1B 55 01		
<ESC> “U” “0”	1B 55 30	Select bi-directional print mode	52
<ESC> “U” <0>	1B 55 00		
<ESC> “@”	1B 40	Initialize printer	52
<ENQ>	05	Enquiry	53
<STX>	02	Enter STX-ETX mode	53
<ETX>	03	Terminate STX-ETX mode	53
<ESC> “d” “0”	1B 64 30	Trigger auto-cutter drive (Auto-cutting models only)	54
<ESC> “d” <0>	1B 64 00		
<ESC> “d” “1”	1B 64 31		
<ESC> “d” <1>	1B 64 01		
<GS>...<LF>	1D...0A	Selection of validation characters (Models with validation function only)	54

7-1. Control Codes Used for Character Setting

FUNCTION	Select international character set
CODE	<ESC> “R” <i>n</i>
DEFINITION RANGE	(1B)H (52)H <i>n</i>
OUTLINE	(00)H ≤ <i>n</i> ≤ (08)H Select the international character set corresponding to the value set for <i>n</i> . <i>n</i> =(00)H: U.S.A. (03)H: England (06)H: Italy (01)H: France (04)H: Denmark (07)H: Spain (02)H: Germany (05)H: Sweden (08)H: Japan The default international characters can also be set with DIP switches, however, setting by control code takes priority over setting by DIP switches. Refer to chapter 11-5 “Code Table”

FUNCTION	Select IBM character set #2
CODE	<ESC> “6” (1B)H (36)H
OUTLINE	Selects IBM character set #2.
NOTE	This code is only valid when the character code table set by DIP switches 2-1 and 2-2 is IBM character set #1 or #2.

FUNCTION	Select IBM character set #1
CODE	<ESC> “7” (1B)H (37)H
OUTLINE	Selects IBM character set #1.
NOTE	This code is only valid when the character code table set by DIP switches 2-1 and 2-2 is IBM character set #1 or #2.

FUNCTION Select 7 × 9 (half dot) font

CODE <ESC> “M”
(1B)H (4D)H

OUTLINE Selects 7 × 9 (half dot) font.
Refer to User’s manual for the maximum number of print columns.
When the power of the printer is turned on, 7 × 9 (half dot) printing is automatically selected.
This code valid only when received at the beginning of a line.

FUNCTION Select 5 × 9 (2 pulses = 1 dot) font

CODE <ESC> “P”
(1B)H (50)H

OUTLINE Selects 5 × 9 (2 pulses = 1 dot) font.
This code is valid only when received at the beginning of a line.

FUNCTION Select 5 × 9 (3 pulses = 1 dot) font

CODE <ESC> “:”
(1B)H (3A)H

OUTLINE Selects 5 × 9 (3 pulses = 1 dot) font.
This code is invalid when using SP311F SP341F SP321S.
This code is valid only when received at the beginning of a line.

FUNCTION Select expanded character mode

CODE <SO>
(0E)H

OUTLINE Data following this code is printed in double-width characters.
Same as <ESC> “W” “1” or <ESC> “W” <1>.

FUNCTION	Cancel expanded character mode
CODE	<DC4> (14)H
OUTLINE	Cancels expanded character mode set by <SO> or <ESC> “W” “1” or <ESC> “W” <1> code. Data following this code is printed out in normal size characters. Same as <ESC> “W” “0” or <ESC> “W” <0>.

FUNCTION	Select expanded character mode
CODE	<ESC> “W” “1” or <ESC> “W” <1> (1B)H (57)H (31)H or (1B)H (57)H (01)H
OUTLINE	Data following this code is printed in double-width characters. Same as <SO>.

FUNCTION	Cancel expanded character mode
CODE	<ESC> “W” “0” or <ESC> “W” <0> (1B)H (57)H (30)H or (1B)H (57)H (00)H
OUTLINE	Cancels expanded character mode set by <ESC> “W” “1” or <ESC> “W” <1> or <SO> code. Data following this code is printed out in normal size characters. Same as <DC4>.

FUNCTION	Select emphasized print mode
CODE	<ESC> “E” (1B)H (45)H
OUTLINE	Data following this code is printed in the emphasized print mode. In this mode, only uni-directional printing is performed.

FUNCTION	Cancel emphasized print mode
CODE	<ESC> “F” (1B)H (46)H
OUTLINE	Cancels emphasized print mode.

FUNCTION Select underline mode

CODE <ESC> “_” “1” or <ESC> “_” <1>
(1B)H (2D)H (31)H or (1B)H (2D)H (01)H

OUTLINE Data following this code is printed out underlined. (However, the spaces generated by horizontal tab are not underlined.)

FUNCTION Cancel underline mode

CODE <ESC> “_” “0” or <ESC> “_” <0>
(1B)H (2D)H (30)H or (1B)H (2D)H (00)H

OUTLINE Cancels underlined mode.

FUNCTION Select upperline mode

CODE <ESC> “_” “1” or <ESC> “_” <1>
(1B)H (5F)H (31)H or (1B)H (5F)H (01)H

OUTLINE Data following this code is printed out with an upperline. (However the spaces generated by horizontal tab are not upperlined.)

FUNCTION Cancel upperline mode

CODE <ESC> “_” “0” or <ESC> “_” <0>
(1B)H (5F)H (30)H or (1B)H (5F)H (00)H

OUTLINE Cancels upperline mode.

FUNCTION Select highlighted print mode

CODE <ESC> “4”
(1B)H (34)H

OUTLINE Prints with highlighted characters.
If an underline, upperline or inverted print command is input while the highlighted print mode is in effect, the highlighted mode will be canceled and the newly input command will be executed. If a highlighted print command is received while the underline, upperline or inverted print mode is in effect, the previously set mode is canceled and the highlighted print mode will be set.

FUNCTION Cancel highlighted print mode

CODE <ESC> “5”
(1B)H (35)H

OUTLINE Cancels highlighted print mode.

FUNCTION Select inverted print mode

CODE <SI>
(0F)H

OUTLINE Data following this code is printed out in inverted characters. This code is valid only when input at the beginning of a line, thus, normal and inverted characters cannot be mixed in on the same line.

FUNCTION Cancel inverted print mode

CODE <DC2>
(12)H

OUTLINE Cancels the inverted character mode. This code is valid only when input at the beginning of a line.

7-2. Control Codes Used for Line Spacing

FUNCTION Line feed

CODE <LF>
(0A)H

OUTLINE Data in the line buffer is printed out and one line is fed. If data does not exist before this code is received, the printer only feeds one line.

FUNCTION Line feed (Same as LF)

CODE <CR>
(0D)H

OUTLINE Functions the same as an LF code.
When DIP SW 1-3 is set to ON, this code becomes invalid.

FUNCTION Set 1/6-inch line feed

CODE <ESC> “z” “1” or <ESC> “z” <1>
(1B)H (7A)H (31)H or (1B)H (7A)H (01)H

OUTLINE Line feed is set at 1/6-inch after this code is received.

FUNCTION Set 1/8-inch line feed

CODE <ESC> “0”
(1B)H (30)H

OUTLINE Line feed is set at 1/8-inch after this code is received.

FUNCTION Feed paper n lines

CODE <ESC> “a” n
(1B)H (52)H n

DEFINITION RANGE $1 \leq n \leq 127$

OUTLINE After data in the line buffer is printed out, feeds the paper n lines.

7-3. Control Codes Used for Page Layout

FUNCTION Page feed (form feed)

CODE <FF>
(0C)H

OUTLINE After data in the line buffer is printed out, feeds the paper to the top of the next page.

FUNCTION Set page length at n lines

CODE <ESC> “C” n
(1B)H (43)H n

DEFINITION RANGE $1 \leq n \leq 255$ (default value friction: $n=33$
Sprocket: $n=42$)

OUTLINE Sets page length at n lines.

FUNCTION Set page length at n inches

CODE <ESC> “C” <0> n
(1B)H (43)H (00)H n

DEFINITION RANGE $1 \leq n \leq 127$

OUTLINE Sets page length at n inches.

FUNCTION

Set vertical tab positions

CODE

<ESC> “B” $n_1 n_2 \dots n_k$ <0>
 (1B)H (42)H $n_1 n_2 \dots n_k$ (00)H

DEFINITION RANGE
 $1 \leq n_1 < n_2 < n_3 < \dots < n_k \leq 255, 1 \leq k \leq 16$
OUTLINE

Cancels all current vertical tab positions and sets new vertical tab positions at lines n_1, n_2 , etc., where n_1, n_2 , etc. are numbers between 1 and 255. A maximum of 16 vertical tab positions can be set. Tab positions must be specified in ascending order; any violation of ascending order terminates the tab position list. Standard termination is by the <0> control code. Vertical tab positions are set in terms of the current line spacing and do not move if the line spacing is changed later.

NOTE

If a tab set position < nk > is equivalent or smaller than < $nk-1$ > just preceding the tab set position, setting of vertical tab is assumed as complete.

FUNCTION

Execute vertical tab

CODE

<VT>
 (0B)H

OUTLINE

Feeds the paper to the next vertical tab set position. When a vertical tab is not set, line feed is not performed. If the current line is at or below the last vertical tab set position, the paper feeds to the top of the next page.

FUNCTION

Set bottom margin

CODE

<ESC> “N” n
 (1B)H (4E)H n

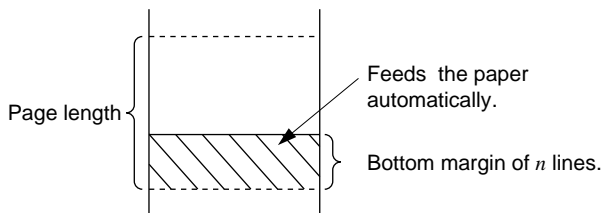
DEFINITION RANGE
 $0 \leq n \leq 255$ (Default $n = 0$)
OUTLINESets bottom margin to n lines.

FUNCTION Cancel bottom margin

CODE <ESC> “O”
(1B)H (4F)H

OUTLINE Cancels bottom margin.

FUNCTION Set left margin

CODE <ESC> “1” *n*
(1B)H (6C)H *n*

DEFINITION RANGE $0 \leq n \leq (\text{right margin} - 2)$

OUTLINE Sets the left margin at column *n* in the current character pitch. The left margin does not move if the character pitch is changed later. The left margin must be at least two columns to the left of the right margin and within the limits above.

FUNCTION Set right margin

CODE <ESC> “Q” *n*
(1B)H (51)H *n*

DEFINITION RANGE $2 \leq n \leq (\text{maximum no. of print columns})$

OUTLINE Sets the right margin at column *n* in the current character pitch. Column *n* becomes the last character position the line. The right margin does not move if the character pitch is changed later. The right margin must be within the limits above.

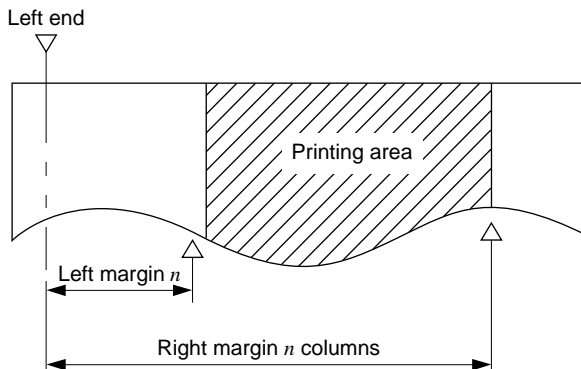

FUNCTION

Set horizontal tab position

CODE

<ESC> “D” *n1 n2...nk* <0>
(1B)H (44)H *n1 n2...nk* (00)H

DEFINITION RANGE

$1 \leq n1 < n2 < n3 \dots < nk \leq (\text{Maximum print columns} - 1)$,
 $1 \leq k \leq 16$

OUTLINE

Cancels all current horizontal tab positions and sets new tab positions at columns *n1*, *n2*, etc. in the current character pitch, where *n1*, *n2*, etc. are numbers between 1 and (Maximum print columns-1). The maximum number of horizontal tab positions allowed is 16. The tab positions must be specified in ascending order; any violation of ascending order terminates the tab position list. Standard termination is by the <0> control code. To clear all tab positions, specify <ESC> “D” <0>.

NOTE

When the horizontal tab set position <*nk*> is equivalent or smaller than <*nk-1*> which is the column just preceding the set tab position, horizontal tab setting is assumed as complete.

FUNCTION

Execute horizontal tab

CODE

<HT>
(09)H

OUTLINE

The print position skips to the next horizontal tab position in line. If the current position is after the final horizontal tab position that can be executed, this code is ignored. (Underlining and overlining do not take place in the spaces between characters set with the horizontal tab function.)

7-4. Control Codes Used for Graphics Printing

FUNCTION	Set $7/72$ -inch line feed
CODE	<ESC> “1” (1B)H (31)H
OUTLINE	Line feed is set at $7/72$ -inch after this code is received.
FUNCTION	Define $n/72$ -inch line feed
CODE	<ESC> “A” n (1B)H (41)H n
DEFINITION RANGE	$0 \leq n \leq 85$ (Default $n = 12$)
OUTLINE	Line feed is defined at $n/72$ -inch after this code is received. This code sets the feed at $n/72$ -inch with the <ESC> “2” code.
FUNCTION	Set $n/72$ -inch line feed
CODE	<ESC> “2” (1B)H (32)H
OUTLINE	This code sets the line feed at a defined value with the <ESC> “A” previously described.
FUNCTION	One time line feed of $n/72$ -inch
CODE	<ESC> “J” n (1B)H (4A)H n
DEFINITION RANGE	$1 \leq n \leq 255$
OUTLINE	This code activates the $n/72$ -inch paper feed once.
FUNCTION	Set $1/12$ -inch line feed
CODE	<ESC> “z” “0” or <ESC> “z” <0> (1B)H (7A)H (30)H or (1B)H (7A)H (00)H
OUTLINE	Line feed is set at $1/12$ -inch after this code is received.

EXAMPLESet $n/216$ -inch line feed simulation**CODE**`<ESC> "3" n`
(1B)H (33)H n **DEFINITION RANGE** $1 \leq n \leq 255$ **OUTLINE**

Line feed is set at $n/216$ -inch after this code is received.
 According to the minimum paper feed pitch of the connected mechanism, the amount of line feed is set as follows:
 For $1/72$ "-pitch mechanisms: $\text{INT} \{(n/3)\}/72$ -inch.
 For $1/144$ "-pitch mechanisms: $\text{INT} \{(2n/3)+0.5\}/144$ -inch.

FUNCTIONSet $n/144$ -inch line feed**CODE**`<ESC> "y" n`
(1B)H (79)H n **DEFINITION RANGE** $1 \leq n \leq 255$ **OUTLINE**

Line feed is set at $n/144$ -inch after this code is received.
 * $1/72$ -inch type mechanism only

FUNCTION

8 dot single density bit image

CODE`<ESC> "K" n1 <0> m1 m2 ...`
(1B)H (4B)H $n1$ (00)H $m1 m2 ...$ **DEFINITION RANGE** $1 \leq n1 \leq 200$ **OUTLINE**

Executes 8 dot bit image print determined by " $n1$ ". The total number of bit image data bytes in one line is equal to $n1$. The printer ignores any data bytes over the specified amount allowed in one line. When the bit image print is finished the printer automatically returns to the character mode.

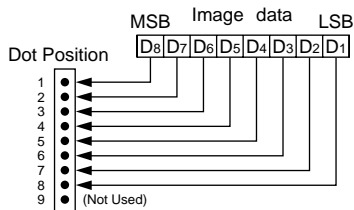

EXAMPLE

Actually, let us consider printing as a means of bit image. We will create the design below using bit image.

	m1	m2	m3	m4	m5	m6	m7	m8	m9	m10	m11	m12	m13	m14	m15	m16	m17	m18	m19	m20	m21	m22	m23	m24	m25	m26	m27	m28	m29	m30
D8																														
D7				●		●																								
D6		●					●	●	●			●	●	●	●	●	●	●	●	●	●	●	●	●	●	●	●	●	●	
D5	●	●	●	●	●	●	●	●	●					●	●	●	●	●	●	●	●	●	●	●	●	●	●	●	●	
D4	●	●	●	●	●	●	●	●	●	●	●	●	●	●	●	●	●	●	●	●	●	●	●	●	●	●	●	●	●	●
D3	●	●	●	●	●	●	●	●	●	●	●	●	●	●	●	●	●	●	●	●	●	●	●	●	●	●	●	●	●	●
D2	●	●	●	●	●	●	●	●	●	●	●	●	●	●	●	●	●	●	●	●	●	●	●	●	●	●	●	●	●	●
D1	●		●	●		●	●		●	●		●	●		●	●		●	●		●	●		●	●		●	●		

First, since the volume of data is 30, $nI = (1E)_H$. If the data $m1 \sim m30$ is converted to hexadecimal, it appears as shown below.

Data	Binary	Hexa-decimal	Data	Binary	Hexa-decimal	Data	Binary	Hexa-decimal
<i>m1</i>	00000001	01	<i>m11</i>	00111110	3E	<i>m21</i>	00111110	3E
<i>m2</i>	00011110	1E	<i>m12</i>	00000010	02	<i>m22</i>	00101110	2E
<i>m3</i>	00111110	3E	<i>m13</i>	00000010	02	<i>m23</i>	00101110	2E
<i>m4</i>	01011111	5F	<i>m14</i>	00111110	3E	<i>m24</i>	00111110	3E
<i>m5</i>	00011111	1F	<i>m15</i>	00111110	3E	<i>m25</i>	00101111	2F
<i>m6</i>	01011110	5E	<i>m16</i>	00101111	2F	<i>m26</i>	00101111	2F
<i>m7</i>	00011110	1E	<i>m17</i>	00101111	2F	<i>m27</i>	00111110	3E
<i>m8</i>	00111111	3F	<i>m18</i>	00111110	3E	<i>m28</i>	00111110	3E
<i>m9</i>	00101111	2F	<i>m19</i>	00101110	2E	<i>m29</i>	00000010	02
<i>m10</i>	00111110	3E	<i>m20</i>	00101110	2E	<i>m30</i>	00000010	02

Printing Samples



FUNCTION

8 dot double density bit image

CODE

<ESC> “L” *n1 n2 m1 m2...*
 (1B)H (4C)H *n1 n2 m1 m2...*

DEFINITION RANGE

$$1 \leq n1 + 256 \times n2 \leq 400$$
OUTLINE

Executes double density bit image printing (half-dot printing) determined by “*n1*” and “*n2*”. The total number of bit image data bytes in one line is equal to $n1 + n2 \times 256$. Refer to <ESC> K as to the relation between the dot position and the bit number. The printer ignores any data bytes over the specified amount allowed in one line.

The printer does not print adjacent dots. When the bit image printing is finished, the printer automatically returns to the character mode.

NOTE

For double density bit image printing, dots cannot be printed overlapping each other in the horizontal direction.

The following is an example of this.

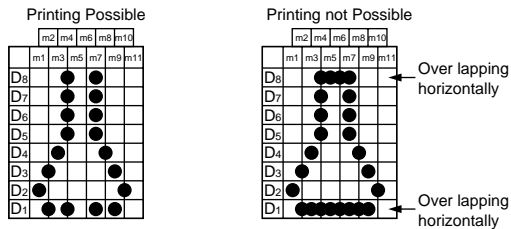

When printing one graphic image of a minimum of two lines with <ESC> K or <ESC>L, feed the paper a minimum of one line before printing so that the line spacing becomes identical between the lines.

FUNCTION Select vertical expanded character mode

CODE <ESC> “h” “1” or <ESC> “h” <1>
(1B)H (68)H (31)H or (1B)H (68)H (01)H

OUTLINE Prints characters two times the normal vertical size after the code is received.
However, the bit image mode <ESC> “K” and <ESC> “L” are excluded.

- NOTE**
- (1) When combined with the <SO> code, this code enables printing of the characters in two times the normal vertical and horizontal size.
 - (2) This code is not combined with the inverted print mode <SI> code.
 - (3) For the 6 × 12 dots IBM block graphic (the characters code table (B0)H-(DF)H and (F4)H-(F5)H of IBM character set #1 and #2) of the font construction, vertical enlargement is not available.
 - (4) The relationship of the vertically enlarged character and the normal character is matched at the lower level.
 - (5) Feed the paper a minimum of one line before printing with this code.

FUNCTION Cancel vertical expanded character mode

CODE <ESC> “h” “0” or <ESC> “h” <0>
(1B)H (68)H (30)H or (1B)H (68)H (00)H

OUTLINE Cancels vertical expanded character mode

7-5. Control Codes Used for Download Characters

FUNCTION

Definition of download characters

CODE

When the 7 × 9 (half dot) font is set (default setting):
 <ESC> “&” <0> $n1\ n2\ [m0\ m1\ m2\ m3\ m4\ m5\ m6\ m7]$
 $n2 - n1 + 1$

(1B)H (26)H (00)H $n1\ n2\ [m0\ m1\ m2\ m3\ m4\ m5\ m6\ m7]$
 $n2 - n1 + 1$

When the 5 × 9 font is set:

<ESC> “&” <0> $n1\ n2\ [m0\ m1\ m2\ m3\ m4\ m5]$ $n2 - n1 + 1$

(1B)H (26)H (00)H $n1\ n2\ [m0\ m1\ m2\ m3\ m4\ m5]$ $n2 - n1 + 1$

DEFINITION RANGE

(21)H ≤ $n1$ ≤ $n2$ ≤ (7F)H, $m0 = (00)H$ or $m0 = (80)H$

OUTLINE

Defines download characters

Up to 10 download characters can be defined and the defined character patterns can be stored in the printer's RAM.

Defining of download characters begins with character code $n1$ and completes with $n2$. When only one character is defined, $n1 = n2$.

$m0$ indicates the relationship between the character pattern and print head.

$m1 = m2...$ Indicate the character pattern

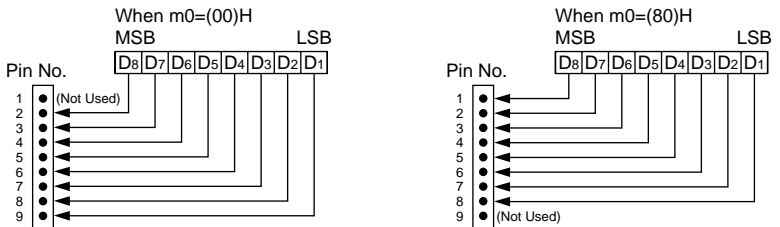

NOTE

When the 7 × 9 (half dot) font is set (the default setting), printing of adjacent horizontal dots is not allowed.

Printing possible

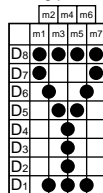

Printing not possible

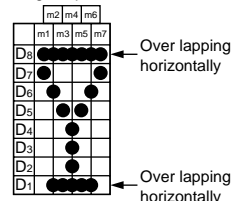

FUNCTION

Enable download character set

CODE

<ESC> “%” “1” or <ESC> “%” <1>
 (1B)H (25)H (31)H or (1B)H (25)H (01)H

OUTLINE

Enables the download character set
 Download characters defined by the ESC & 0 code cannot be printed until enabled by this command.

FUNCTION

Disable download character set

CODE

<ESC> “%” “0” or <ESC> “%” <0>
 (1B)H (25)H (30)H or (1B)H (25)H (00)H

OUTLINE

Disables the selected download character set and selects the built-in character set. When the power of the printer is initially turned on, the built-in character set is selected.

EXAMPLE

To print a download character when the 7 × 9 (half dot) font character size is set.

- (1) Design the download character to be used at code positions (21)H, (22)H, and (23)H.

	m2	m4	m6	
	m1	m3	m5	m7
D8	●	●	●	●
D7	●	●	●	●
D6	●	●	●	●
D5	●	●	●	●
D4	●	●	●	●
D3	●	●	●	●
D2	●	●	●	●
D1	●	●	●	●

Char. Code=(21)H

	m2	m4	m6	
	m1	m3	m5	m7
D8	●	●	●	●
D7	●	●	●	●
D6	●	●	●	●
D5	●	●	●	●
D4	●	●	●	●
D3	●	●	●	●
D2	●	●	●	●
D1	●	●	●	●

Char. Code=(22)H

	m2	m4	m6	
	m1	m3	m5	m7
D8	●	●	●	●
D7	●	●	●	●
D6	●	●	●	●
D5	●	●	●	●
D4	●	●	●	●
D3	●	●	●	●
D2	●	●	●	●
D1	●	●	●	●

Char. Code=(23)H

- (2) Define the download characters.

When character codes where the download character is written are specified as (21)H, (22)H, (23)H, $n1 = (21)H$, $n2 = (23)H$ are obtained.

If the relationship between the character pattern data and printing head is specified to “not use pin 9”, $m0 = (80)H$ is obtained. When data $m1$ to $m7$ are converted into hexadecimal data, they are indicated as follows.

Data	Binary	Hexa-decimal	Data	Binary	Hexa-decimal	Data	Binary	Hexa-decimal
<i>m1</i>	10100000	A0	<i>m1</i>	10011000	98	<i>m1</i>	00111000	3C
<i>m2</i>	00000000	00	<i>m2</i>	01100100	64	<i>m2</i>	01000010	42
<i>m3</i>	10100000	A0	<i>m3</i>	10000010	82	<i>m3</i>	10100101	A5
<i>m4</i>	00011111	1F	<i>m4</i>	00000001	01	<i>m4</i>	00000000	00
<i>m5</i>	10100000	A0	<i>m5</i>	10000010	82	<i>m5</i>	10100101	A5
<i>m6</i>	00000000	00	<i>m6</i>	01100100	64	<i>m6</i>	01000010	42
<i>m7</i>	10100000	A0	<i>m7</i>	10011000	98	<i>m7</i>	00111000	3C

Example of transmitting data

(1) Definition of down-load characters	(1B)H (26)H (00)H (21)H (23)H (80)H (A0)H (00)H (A0)H (1F)H (A0)H (00)H (A0)H (80)H (98)H (64)H (82)H (01)H (82)H (64)H (98)H (80)H (3C)H (42)H (A5)H (00)H (A5)H (42)H (3C)H
(2) Selecting the down-load character set	(1B)H (25)H (31)H
(3) Character codes	(21)H (22)H (23)H (0A)H
(4) Canceling the down-load character set	(1B)H (25)H (30)H
(5) Character codes	(21)H (22)H (23)H (0A)H

Printing Samples

70
11H

7-6. Control Codes Used for Peripheral Units

FUNCTION

Adjust drive pulse width for peripheral unit 1

CODE

<ESC> <BEL> $n1\ n2$
(1B)H (07)H $n1\ n2$

DEFINITION RANGE

$1 \leq n1 \leq 127, 1 \leq n2 \leq 127$ (default setting $n1 = n2 = 20$)

OUTLINE

Adjusts drive pulse width for peripheral devices requiring other than standard 200 ms pulse time and delay time
Energizing time = $10 \times n1$ (ms)
Delay time = $10 \times n2$ (ms)
Executed by <BEL>, <FS> codes.

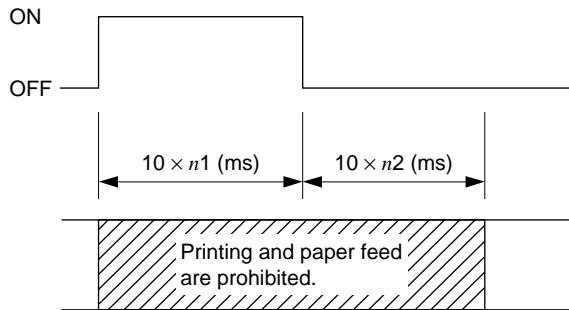
**NOTE**

Adjustment is not necessary for standard cash drawers in the U.S.A. market.

FUNCTION

Deferred drive command for peripheral unit 1

CODE

<BEL>
(07)H

OUTLINE

Executes drive pulse for peripheral unit 1 (deferred).

FUNCTION

Immediate drive command for peripheral unit 1

CODE

<FS>
(1C)H

OUTLINE

Executes drive pulse for peripheral unit 1 (immediate).
This code differs from the <BEL> code as follows:
When the printer receives an <FS> code, the command is executed immediately. The <BEL> code is stored in the data buffer in the same manner as other codes, and executed in the order in which they are received.

FUNCTION	Immediate drive command for peripheral unit 2
CODE	<SUB> (1A)H
OUTLINE	Drives peripheral unit 2. Pulse width is fixed at 200ms with a fixed delay time of 200 ms. When the printer receives a <SUB> code, the command is executed immediately. Same as
NOTE	Peripheral units 1 and 2 cannot be driven simultaneously.

FUNCTION	Immediate drive command for peripheral unit 2
CODE	 (19)H
OUTLINE	Dives peripheral unit 2. Pulse width is fixed at 200 ms with a fixed delay time of 200 ms. When the printer receives a code, the command is executed immediately. Same as <SUB>.
NOTE	Peripheral units 1 and 2 cannot be driven simultaneously.

7-7. Other Control Codes

FUNCTION	Sound buzzer
CODE	<RS> (1E)H
OUTLINE	A short alarm is generated by the printer.

FUNCTION	Cancel print data in buffer & Initialize printer
CODE	<CAN> (18)H
OUTLINE	Clears the data buffer and line buffer and initializes (<ESC> “@”) all commands already set. However, the following parameters are not initialized: external device drive pulse width setting, operation switch valid/invalid selection, online switch valid/invalid selection. For a serial interface printer, the select/deselect state for addressable mode and DC1/DC3 mode is not affected. In STX-ETX mode, this CAN code clears the data between STX and ETX and the line buffer, but does not initialize the commands.

FUNCTION

Set deselect mode

CODE

<DC3>
(13)H

OUTLINE

- (1) When using serial interface printer:
This function differs depending on the setting of DIP switch 4.
- When the DC1, DC3 invalid mode is set (DIP switches 4-1 to 4-4 are all set to ON), the printer ignores this code.
 - In the DC1, DC3 valid mode (with DIP switches 4-1 to 4-4 set to OFF), data following this code is ignored when the printer receives a <DC3> code.
The deselect mode is canceled by <DC1> code.
 - If the printer receives a <DC3> code during an addressable mode (with DIP switches 4-1 to 4-4 set to settings other than a) and b) above, the data following this code is ignored.
Deselect mode can be canceled by a <DC1> *n* code.
Note that addressable mode is valid only when the RS-422A interface option is installed.
- (2) When using parallel interface printer;
Data following this code is ignored when the printer receives a <DC3> code.
The deselect mode is canceled by <DC1> code.

FUNCTION

Set select mode

CODE

When using serial interface printer;
<DC1> or <DC1>*n*
(11)H or (11)H *n*

When using parallel interface printer
<DC1>
(11)H

OUTLINE

- (1) When using serial interface printer;
This function differs depending on the setting of DIP switch 4.
- When the DC1, DC3 invalid mode is set (DIP switches 4-1 to 4-4 are all set to ON), the printer ignores this code.
 - In the DC1, DC3 valid mode (with DIP switches 4-1 to 4-4 set to OFF), when the printer receives a <DC1> code, the deselect mode is canceled and data following this code is input to the buffer.

- c) If the printer receives a <DC1> *n* code (*n* is the DIP switch controlled address) during the addressable mode (with DIP switches 4-1 to 4-4 set other than settings a) and b) above.), the deselect mode is canceled and data following this code is input to the buffer.
Note that addressable mode is valid only when optional RS-422A interface is installed.
- (2) When using parallel interface printer;
When the printer receives a <DC1> code, the deselect mode is canceled and data following this code is input to the buffer.

FUNCTION	Select uni-directional print mode
CODE	<ESC> “U” “1” or <ESC> “U” <1> (1B)H (55)H (31)H or (1B)H (55)H (01)H
OUTLINE	Prints only when the print head moves from left to right.
FUNCTION	Select bi-directional print mode
CODE	<ESC> “U” “0” or <ESC> “U” <0> (1B)H (55)H (30)H or (1B)H (55)H (00)H
OUTLINE	Returns to the standard bi-directional print mode. (This mode is set automatically when the printer power is turned on.)
FUNCTION	Initialize printer
CODE	<ESC> “@” (1B)H (40)H
OUTLINE	Initializes all the commands already set. However the following parameters are not initialized: eternal device drive pulse width setting, operation switch valid/invalid selection, online switch valid/invalid selection. Also, the line and data buffers are not cleared and the DIP switches are not read in again. For a serial interface printer, the select/deselect state for addressable mode and DC1/DC3 mode is not affected.

FUNCTION Enquiry

CODE <ENQ>
(05)H

OUTLINE This code is valid when using serial interface printer.
Online in STX-ETX mode: The printer sends the status data and the check byte to the host computer.
Online in any other mode: The printer sends only the status data to the host computer.
Offline in any mode: The printer only sends the status data to the host computer if there is a mechanical error in the status bit, or if the paper out or power down bit is set.

NOTE When IBM character set #2 is selected by character code, codes <ENQ> does not exist. (In this instance, select another code.)

	U.S.A. & Europe	IBM #1	IBM #2	Japan
(05)H	<ENQ>	<ENQ>	♣	<ENQ>

FUNCTION Enter STX-ETX mode

CODE <STX>
(02)H

OUTLINE This code is valid when using serial interface printer.
STX-ETX mode is set.

FUNCTION Terminate STX-ETX mode

CODE <ETX>
(03)H

OUTLINE This code is valid when using serial interface printer.
Terminates the STX-ETX mode and prints out the text data.

NOTE When IBM character set #2 is selected by character code, codes <ETX> does not exist. (In this instance, select another code).

	U.S.A. & Europe	IBM #1	IBM #2	Japan
(03)H	<ETX>	<ETX>	♥	<ETX>

FUNCTION Trigger auto-cutter drive (Auto-cutting models only)

CODE <ESC> “d” “0” or <ESC> “d” <0>
(1B)H (64)H (30)H or (1B)H (64)H (00)H
<ESC> “d” “1” or <ESC> “d” <1>
(1B)H (64)H (31)H or (1B)H (64)H (01)H

OUTLINE This code causes the printer to trigger auto-cutter.

FUNCTION Select validation printing (Models with validation function only)

CODE <GS> data <LF>
(1D)H data (0A)

OUTLINE Prints up to 32 columns of the 7 × 9 (half dot) font size characters on one line.

NOTE

- (1) Character data and immediate execution command <CAN> <SUB> <LF> are valid for data.
- (2) Printing modes (such as emphasized, inverted, expanded character modes, etc.) which were set before validation printing are invalid during validation printing. (These modes become valid again after validation printing is completed.)
(Refer to “5. VALIDATION PRINTING”)

8. CHARACTER CODE TABLES

8.1 U.S.A. & Europe (DIP SW2-1: ON, SW2-2: ON)

Hexa- decimal	0	1	2	3	4	5	6	7
0	0	16	SP	0	@	P		p
1	1	17	<DC1>	1	A	Q	a	q
2	2	18	<DC2>	2	B	R	b	r
3	3	19	<DC3>	3	C	S	c	s
4	4	20	<DC4>	4	D	T	d	t
5	5	21	%	5	E	U	e	u
6	6	22	&	6	F	V	f	v
7	7	23	<BEL>	7	G	W	g	w
8	8	24	<CAN>	8	H	X	h	x
9	9	25		9	I	Y	i	y
A	10	26	<LF>	:	J	Z	j	z
B	11	27	<SUB>	+	K	[k	{
C	12	28	<ESC>	;	L	\	l	
D	13	29	<FF>	<	M]	m	}
E	14	30	<FS>	=	N	^	n	~
F	15	31	<CR>	-	O	_	o	⊗
		32	<GS>	.				
		33	<RS>	/	?			
		34						
		35						
		36						
		37						
		38						
		39						
		40						
		41						
		42						
		43						
		44						
		45						
		46						
		47						
		48						
		49						
		50						
		51						
		52						
		53						
		54						
		55						
		56						
		57						
		58						
		59						
		60						
		61						
		62						
		63						
		64						
		65						
		66						
		67						
		68						
		69						
		70						
		71						
		72						
		73						
		74						
		75						
		76						
		77						
		78						
		79						
		80						
		81						
		82						
		83						
		84						
		85						
		86						
		87						
		88						
		89						
		90						
		91						
		92						
		93						
		94						
		95						
		96						
		97						
		98						
		99						
		100						
		101						
		102						
		103						
		104						
		105						
		106						
		107						
		108						
		109						
		110						
		111						
		112						
		113						
		114						
		115						
		116						
		117						
		118						
		119						
		120						
		121						
		122						
		123						
		124						
		125						
		126						
		127						

(SP: Space)

Hexa- decimal	8	9	A	B	C	D	E	F
0	SP 128	┘ 144	Ä 160	é 176	ù 192	ā 208	┘ 224	┘ 240
1	┘ 129	┘ 145	Ö 161	è 177	ū 193	â 209	┘ 225	┘ 241
2	┘ 130	· 146	Ü 162	ē 178	û 194	° 210	┘ 226	┘ 242
3	┘ 131	· 147	ß 163	ê 179	ç 195	°C 211	┘ 227	┘ 243
4	┘ 132	· 148	§ 164	ï 180	ç 196	°F 212	┘ 228	┘ 244
5	┘ 133	· 149	ā 165	í 181	ñ 197	Ω 213	┘ 229	┘ 245
6	┘ 134	/ 150	o 166	ì 182	ñ 198	μ 214	┘ 230	┘ 246
7	┘ 135	\ 151	f 167	ï 183	Ē 199	Σ 215	┘ 231	┘ 247
8	┘ 136	▾ 152	ç 168	î 184	ç 200	σ 216	■ 232	┘ 248
9	┘ 137	▾ 153	1/2 169	ö 185	ì 201	ā 217	■ 233	▾ 249
A	┘ 138	┘ 154	N T 170	ó 186	Å 202	TL 218	┘ 234	▾ 250
B	┘ 139	┘ 155	X 171	ò 187	φ 203	X 219	┘ 235	= 251
C	┘ 140	┘ 156	¥ 172	ō 188	θ 204	∞ 220	┘ 236	 252
D	┘ 141	┘ 157	1/4 173	ô 189	ä 205	± 221	┘ 237	┘ 253
E	┘ 142	· 158	ā 174	ü 190	á 206	÷ 222	┘ 238	┘ 254
F	┘ 143	x 159	ë 175	ú 191	à 207	π 223	┘ 239	┘ 255

(SP: Space)

8.2 IBM Character Set #1 (DIP SW2-1: OFF, SW2-2: ON)

Hexa- decimal	0	1	2	3	4	5	6	7
0	0	16	SP	0	@	P	`	p
1	1	<DC1>	!	1	A	Q	a	q
2	<STX>	<DC2>	"	2	B	R	b	r
3	<ETX>	<DC3>	#	3	C	S	c	s
4	4	<DC4>	\$	4	D	T	d	t
5	<ENQ>	5	%	5	E	U	e	u
6	6	22	&	6	F	V	f	v
7	<BEL>	7	'	7	G	W	g	w
8	8	<CAN>	(8	H	X	h	x
9	<HT>)	9	I	Y	i	y
A	<LF>	<SUB>	*	:	J	Z	j	z
B	<VT>	<ESC>	+	;	K	[k	{
C	<FF>	<FS>	,	<	L	\	l	
D	<CR>	<GS>	-	=	M]	m	}
E	<SO>	<RS>	.	>	N	^	n	~
F	<SI>	15	/	?	O	_	o	

(SP: Space)



Hexa- decimal	8	9	A	B	C	D	E	F
0	128	144	á 160	⋮ 176	Ł 192	⋈ 208	α 224	≡ 240
1	129	<DC1> 145	í 161	⋮ 177	⊥ 193	⊟ 209	β 225	± 241
2	<STX> 130	<DC2> 146	ó 162	⋮ 178	⊤ 194	⊠ 210	Γ 226	≥ 242
3	<ETX> 131	<DC3> 147	ú 163	⋮ 179	⊥ 195	⋈ 211	π 227	≤ 243
4	132	<DC4> 148	ñ 164	⋮ 180	− 196	⋈ 212	Σ 228	∫ 244
5	<ENQ> 133	149	Ñ 165	⋮ 181	⊥ 197	⊟ 213	σ 229	∫ 245
6	134	150	à 166	⋮ 182	⊥ 198	⊠ 214	μ 230	÷ 246
7	<BEL> 135	151	ò 167	⋮ 183	⋈ 199	⋈ 215	τ 231	≈ 247
8	136	<CAN> 152	ı 168	⋮ 184	⋈ 200	⊟ 216	Φ 232	° 248
9	<HT> 137	 153	ƒ 169	⋮ 185	⊟ 201	⊤ 217	Θ 233	• 249
A	<LF> 138	<SUB> 154	ƒ 170	⋮ 186	⋈ 202	⊟ 218	Ω 234	− 250
B	<VT> 139	<ESC> 155	½ 171	⋮ 187	⊟ 203	■ 219	δ 235	√ 251
C	<FF> 140	<FS> 156	¼ 172	⋮ 188	⋈ 204	■ 220	∞ 236	∩ 252
D	<CR> 141	<GS> 157	ı 173	⋮ 189	= 205	⋮ 221	φ 237	² 253
E	<SO> 142	<RS> 158	« 174	⋮ 190	⋈ 206	⋮ 222	€ 238	• 254
F	<SI> 143	159	» 175	⋮ 191	⋈ 207	■ 223	∩ 239	255

(SP: Space)

8.3 IBM Character Set #2 (DIP SW2-1: ON, SW2-2: OFF)

Hexa- decimal	0	1	2	3	4	5	6	7
0	0	16	SP	0	@	P		p
1	1	<DC1>	!	1	A	Q	a	q
2	<STX>	<DC2>	"	2	B	R	b	r
3	♥	<DC3>	#	3	C	S	c	s
4	♦	<DC4>	\$	4	D	T	d	t
5	♣	§	%	5	E	U	e	u
6	♠		&	6	F	V	f	v
7	<BEL>		'	7	G	W	g	w
8		<CAN>	(8	H	X	h	x
9	<HT>)	9	I	Y	i	y
A	<LF>	<SUB>	*	:	J	Z	j	z
B	<VT>	<ESC>	+	;	K	[k	{
C	<FF>	<FS>	,	<	L	\	l	
D	<CR>	<GS>	-	=	M]	m	}
E	<SO>	<RS>	.	>	N	^	n	~
F	<Sl>		/	?	O	-	o	

(SP: Space)

Hexa-decimal	8	9	A	B	C	D	E	F
0	Ç 128	É 144	á 160	 176	L 192	⋈ 208	α 224	≡ 240
1	ü 129	æ 145	í 161	 177	⊥ 193	⌣ 209	β 225	± 241
2	é 130	Æ 146	ó 162	 178	⊤ 194	π 210	Γ 226	≥ 242
3	â 131	ô 147	ú 163	179	⌋ 195	⋈ 211	π 227	≤ 243
4	ä 132	ö 148	ñ 164	⌈ 180	- 196	⌘ 212	Σ 228	∫ 244
5	à 133	ò 149	Ñ 165	⌋ 181	⌈ 197	⌘ 213	σ 229	J 245
6	á 134	û 150	à 166	⌋ 182	⌈ 198	⌘ 214	μ 230	÷ 246
7	ç 135	ù 151	ó 167	π 183	⌋ 199	⌈ 215	τ 231	≈ 247
8	ê 136	ÿ 152	ı 168	ƒ 184	⌈ 200	⌈ 216	Φ 232	° 248
9	ë 137	Ö 153	ƒ 169	⌋ 185	⌈ 201	⌈ 217	Θ 233	· 249
A	è 138	Ü 154	ƒ 170	⌋ 186	⌈ 202	⌈ 218	Ω 234	- 250
B	ï 139	Ç 155	½ 171	ƒ 187	⌈ 203	■ 219	δ 235	√ 251
C	î 140	£ 156	¼ 172	⌋ 188	⌈ 204	■ 220	∞ 236	∩ 252
D	ì 141	¥ 157	ı 173	⌋ 189	= 205	⌋ 221	φ 237	² 253
E	Ä 142	Ɔ 158	« 174	ƒ 190	⌈ 206	⌋ 222	ε 238	· 254
F	Å 143	f 159	» 175	ƒ 191	⌈ 207	■ 223	∩ 239	

(SP: Space)

8.4 JAPAN (DIP SW2-1.: OFF, SW2-2: OFF)

Hexa-decimal	0	1	2	3	4	5	6	7
0	0	16	SP	0	@	P	`	p
1	1	<DC1>	!	1	A	Q	a	q
2	<STX>	<DC2>	"	2	B	R	b	r
3	<ETX>	<DC3>	#	3	C	S	c	s
4	4	<DC4>	\$	4	D	T	d	t
5	<ENQ>	5	%	5	E	U	e	u
6	6	6	&	6	F	V	f	v
7	<BEL>	7	'	7	G	W	g	w
8	8	<CAN>	(8	H	X	h	x
9	<HT>)	9	I	Y	i	y
A	<LF>	<SUB>	*	:	J	Z	j	z
B	<VT>	<ESC>	+	;	K	[k	{
C	<FF>	<FS>	,	<	L	¥	l	l
D	<CR>	<GS>	-	=	M]	m	}
E	<SO>	<RS>	.	>	N	^	n	-
F	<Sl>	15	/	?	O	-	o	⊗

(SP: Space)

	8	9	A	B	C	D	E	F
0	SP 128	┌ 144	SP 160	ー 176	夕 192	ミ 208	┐ 224	└ 240
1	┌ 129	┌ 145	。○ 161	ア 177	チ 193	ム 209	─ 225	─ 241
2	─ 130	・ 146	┌ 162	イ 178	ツ 194	メ 210	─ 226	─ 242
3	┌ 131	・ 147	┌ 163	ウ 179	テ 195	モ 211	┐ 227	─ 243
4	─ 132	・ 148	、 164	エ 180	ト 196	ヤ 212	└ 228	┐ 244
5	┌ 133	・ 149	・ 165	オ 181	ナ 197	ユ 213	┌ 229	┐ 245
6	─ 134	／ 150	ヲ 166	カ 182	ニ 198	ヨ 214	└ 230	┐ 246
7	┌ 135	＼ 151	ア 167	キ 183	ヌ 199	ラ 215	┐ 231	┐ 247
8	─ 136	▼ 152	イ 168	ク 184	ネ 200	リ 216	■ 232	┐ 248
9	┌ 137	▼ 153	ウ 169	ケ 185	ノ 201	ル 217	■ 233	▲ 249
A	─ 138	┌ 154	エ 170	コ 186	ハ 202	レ 218	└ 234	▲ 250
B	┌ 139	└ 155	オ 171	サ 187	ヒ 203	ロ 219	← 235	＝ 251
C	└ 140	└ 156	ヤ 172	シ 188	フ 204	ワ 220	↑ 236	＝ 252
D	─ 141	└ 157	ユ 173	ス 189	ヘ 205	ン 221	→ 237	┐ 253
E	└ 142	・ 158	ヨ 174	セ 190	ホ 206	ヽ 222	↓ 238	┐ 254
F	└ 143	× 159	ツ 175	ソ 191	マ 207	。 223	┐ 239	┐ 255

(SP: Space)

8.5 International Character Sets

Hexadecimal	23	24	40	5B	5C	5D	5E	60	7B	7C	7D	7E
U. S. A.	#	\$	@	[\]	^	'	{		}	~
France	#	\$	à	°	ç	§	^	'	é	ù	è	¨
Germany	#	\$	§	Ä	Ö	Ü	^	'	ä	ö	ü	ß
England	£	\$	@	[\]	^	'	{		}	~
Denmark	#	\$	@	Æ	Ø	Å	^	'	æ	ø	å	~
Sweden	#	¤	É	Ä	Ö	Å	Ü	é	ä	ö	å	ü
Italy	#	\$	@	°	\	é	^	ù	à	ò	è	ì
Spain	₧	\$	@	ı	Ñ	¿	^	'	¨	ñ	}	~
Japan	#	\$	@	[¥]	^	'	{		}	—

MEMO



HEAD OFFICE

STAR MICRONICS CO., LTD.

20-10 Nakayoshida, Shizuoka, 422 Japan

Tel: (054) 263-1115, Telefax: (054) 263-8714

OVERSEAS SUBSIDIARY COMPANIES

STAR MICRONICS AMERICA, INC.

70-D Ethel Road West, Piscataway, NJ 08854 U.S.A

Tel: (908) 572-9512, Telefax: (908) 572-5095,

Telex: 299766 STAR UR

STAR MICRONICS DEUTSCHLAND GMBH

Westerbachstraße 59, D-60489 Frankfurt/Main 90, Germany

Tel: 0697-89990, Telefax: 0697-81006, Telex: 417 5825 STAR D

STAR MICRONICS U.K. LTD.

Star House, Peregrine Business Park, Gomm Road,

High Wycombe, Bucks, HP13 7DL, UK

Tel: 01494-471111, Telefax: 0494-473333

Free Manuals Download Website

<http://myh66.com>

<http://usermanuals.us>

<http://www.somanuals.com>

<http://www.4manuals.cc>

<http://www.manual-lib.com>

<http://www.404manual.com>

<http://www.luxmanual.com>

<http://aubethermostatmanual.com>

Golf course search by state

<http://golfingnear.com>

Email search by domain

<http://emailbydomain.com>

Auto manuals search

<http://auto.somanuals.com>

TV manuals search

<http://tv.somanuals.com>