

User Manual

Remote control and programming unit

RCC-02 and RCC-03 for the Xtender



Studer Innotec
Rue des Casernes 57
CH - 1950 Sion
Tel: +41 (0)27 205 60 80
Fax: +41 (0)27 205 60 88
E-mail: info@studer-innotec.com
Web: www.studer-innotec.com

V 2.1



Studer Innotec

Reference

This document applies to versions of firmware V1.2.0 or higher of the remote control.

Copyright

Copyright © Studer Innotec. All rights reserved

Table of contents

Foreword.....	7
Conventions	7
Product recycling	7
Studer Innotec contact details	8
Your reseller' contact details	8
Warnings and caution	8
Warnings and caution	9
Warranty	9
Limitation of responsibility	9
Safety instructions	9
Acceptance of the software licence and updates	9
Introduction.....	11
Models concerned.....	11
Controls and indicators	11
SD card.....	11
Connection	12
Series connection	12
Dimensions.....	13
RCC-02	13
RCC-03	13
Quick Start Guide.....	14
Adjustment of the language	14
Adaptation to the source	14
Adaptation to the batterie	15
Activation of the function Smart-Boost	16
Basic displays	17
Activating and deactivating the combi Xtender.....	18
Adjustment of the RCC remote control.....	19
Adjustment of the language {5000}	19
Adjustment of date {5002} and time {5001}	19
Adjustment of the contrast {5006}	19
Adjustment of the back-lighting {5007}	19
Back-lighting always off {5008}.....	19
Duration of the back-lighting {5009}.....	20
Red back-lighting if the Xtender is OFF and if there is a fault {5026}.....	20
Inactivity period before returning to the standard display {5010}.....	20
Duration of display for quick messages {5011}	20
Acoustic alarm {5027}.....	20
User level {5012}	20
Drive the remote control to the user level basic {5019}	20
Backup and restoring {5013}.....	20
Backup of statistics {5014}	20
Backup of remote control configurations {5015}.....	21
Backup of Xtender configurations {5017}	21
Loading the remote control configurations {5016}	21
Loading the Xtender configurations {5018}.....	21
Loading a master file {5034}.....	21
Separator of the csv files {5032}.....	21
Information on the operating mode of the installation	22
Display of the parallel and three-phase systems	23
Event history	24
Alarm Low battery voltage	24
Stop Battery voltage too low.....	24
Stop High battery voltage.....	24
Message AC IN synchronisation in progress.....	24
Error Incorrect input frequency	25
Error Input voltage too high	25
Error Input voltage too low.....	25

Stop Inverter overvoltage	25
Stop Overtemperature	25
Stop Excessive battery voltage ripple	25
Message Power sharing exceeded; transfer prohibited	26
Error Voltage at AC Out	26
Error Phase not defined	26
Stored events	26
Adjustment of the combi Xtender	27
General	27
Configuration on a system with several Xtenders	27
Utilisation and access levels	27
Pre-defined functions of the auxiliary relays	27
Menu	27
Basic configurations {1100}.....	28
Maximum current of the AC source (power sharing) {1107}.....	28
Locking {1123}.....	28
Authorised inverter {1124}	28
Authorised charger {1125}	29
Smart boost authorised {1126}.....	29
Authorised transfer {1128}	29
Automatic restart {1129}	29
Number of battery under-voltages allowed before final stop {1304} and	29
Leadtime to counting the battery under-voltages allowed before final stop {1404}	29
Number of critical battery under-voltages before final stop {1305} and	30
Leadtime to counting the critical battery under-voltages allowed before final stop {1405}	30
Restore default configurations {1395}.....	30
Battery cycle and charger {1137}	30
Charge current {1138}.....	33
Temperature correction coefficient {1139}.....	33
Battery maintenance voltage (floating) {1140}	33
Force passage to floating mode {1467}.....	33
New cycle {1141}	33
Force new cycle {1142}.....	33
Voltage 1 for a new cycle {1143} and Duration at undervoltage 1 for a new cycle {1144}	33
Voltage 2 for a new cycle {1145} and Duration at undervoltage 2 for a new cycle {1146}	33
New priority cycle on the absorption and equalization phases {1149}.....	33
Absorption phase {1451}	34
Authorised absorption {1155}	34
Absorption voltage {1156}.....	34
Duration of absorption {1157}.....	34
Completion of absorption released by the current {1158}.....	34
Current at end of absorption {1159}.....	34
Equalization phase {1452}.....	34
Start equalization {1162}.....	34
Authorised equalization {1163}.....	34
Equalization before absorption phase {1291}.....	35
Equalization current {1290}.....	35
Equalization voltage {1164}	35
Duration of equalization {1165}.....	35
Number of cycles prior to equalization {1166}.....	35
Equalization at set intervals {1284}	35
Weeks between equalizations {1285}	35
End of equalization activated by the current {1168}	36
End of equalization current {1169}.....	36
Inverter configurations {1186}	36
Standby level {1187}	36

Output voltage {1286}.....	36
Level of battery under-voltage at no load {1108}.....	37
Acoustic alarm of the battery under-voltage {1196}.....	37
Duration of the acoustic alarm {1469}.....	37
Combi configurations Inverter-Charger {1197}.....	37
Minimum AC In voltage to authorise the charging {1309}.....	37
Transfer AC-In for delayed transfer opening {1199}.....	37
Delay before passing to inverter {1198}.....	38
Immediate transfer AC-In voltage {1200}.....	38
Activate immediate detection of grid outage (UPS) {1435}.....	38
Authorisation for exceeding the power sharing current without interrupting the transfer {1436}.....	38
.....	38
Solsafe presence {1438}.....	38
Delay before closing of the transfer relay {1528}.....	38
Configurations for auxiliary contacts 1 and 2 {1201} {1310}.....	38
Simple functions.....	39
Switching mode {1202} {1311}.....	39
Combination of events mode {1497} {1498}.....	39
Limit the time of activation {1512} {1513}.....	40
Maximum duration of activation {1514} {1515}.....	40
Temporal restrictions {1203} {1312}.....	40
Contacts activated by an event {1455} {1456}.....	40
Xtender OFF {1225} {1333}.....	40
Battery undervoltage alarm {1226} {1334}.....	40
Battery overvoltage {1227} {1335}.....	40
Inverter or smart boost overload {1228} {1336}.....	41
Overtemperature {1229} {1337}.....	41
No Overtemperature alarm {1520} {1521}.....	41
Active charger {1231} {1339}.....	41
Active inverter {1232} {1340}.....	41
Smart boost active {1233} {1341}.....	41
AC In present with fault {1234} {1342}.....	41
AC In present {1235} {1343}.....	41
Transfer relay drawn {1236} {1344}.....	41
AC Out present {1237} {1345}.....	41
Battery charging in bulk charge phase {1238} {1346}.....	41
Battery charging in absorption phase {1239} {1347}.....	41
Battery charging in equalization phase {1240} {1348}.....	41
Battery charging in floating phase {1242} {1350}.....	41
Contacts activated by the battery voltage {1245} {1353}.....	41
Dynamic compensation of the thresholds {1288} {1354}.....	42
Deactivate if the battery is in floating mode {1516} {1517}.....	42
Contacts activated by inverter power or smart boost {1257} {1366}.....	42
Contacts activated with set schedules {1269} {1378}.....	42
Extended functions {1489}.....	43
Generator startup {1490}.....	43
Generator startup {1491}.....	43
Duration of starter impulse {1492}.....	43
Number of startup attempts {1493}.....	43
Duration between the starter attempts {1494}.....	43
Multi Xtender {1282}.....	43
3-phase integral mode {1283}.....	43
Information on the system.....	44
Remote controls.....	44
Xtender.....	44
Updates.....	45
Updating process.....	45
Compatibility.....	45
Application examples.....	46

Studer Innotec



général use : Inverter, Charger with grid	46
Use of a limited power source	46
Use to increase the power on an existing installation	47
Load shedding of the second priority loads	47
Annexes	48
Annexe 1 : List of configuration interdependencies	48
Notes	50

FOREWORD

This manual contains information relating to the functioning of the RCC-02 and RCC-03 remote controls.

The use of certain functions sometimes requires increased knowledge in various fields. This manual cannot provide this. In case of doubt, please contact your reseller or installer.

CONVENTIONS

	This symbol is used to indicate the presence of a dangerous voltage that is sufficient to constitute a risk of electric shock.
	This symbol is used to indicate a risk of material damage.
	This symbol is used to indicate information that is important or which serves to optimise your system.

Terminology:

The following terms are used in the manual to provide greater clarity:

RCC is used to indicate the remote control RCC-02 or RCC-03 if the description applies to both models.

Installation is used to describe all the electrical equipment connected together. This may be the source (public grid or generator), and one or more Xtender(s) with or without remote control as well as electrical consumers.

System is used to describe the entirety of Xtenders with or without remote control.

Xtender or combi is used to describe one or more Xtender(s) connected together.

PRODUCT RECYCLING

The RCC remote control conforms to the European directive 2002/95/EC on hazardous substances and does not contain the following elements: lead, cadmium, mercury, hexavalent chrome, PBB or PBDE.



To dispose of this product, please use the service for the collection of electrical waste and observe all applicable obligations according to the place of purchase.

Studer Innotec

STUDER INNOTEK CONTACT DETAILS

Studer Innotec
Rue des Casernes 57
CH – 1950 Sion

Tel. +41 (0)27 205 60 80
Fax. +41 (0)27 205 60 88

Customer service: info@studer-innotec.com
After-sales service: sales@studer-innotec.com
Technical support: support@studer-innotec.com

Website: www.studer-innotec.com

YOUR RESELLER' CONTACT DETAILS



WARNINGS AND CAUTION

WARRANTY

Studer Innotec issues on this product, which they have manufactured and offered for sale, a two year warranty against any material defect or manufacturing fault from the date of despatch by an agreed Studer Innotec distributor.

Any warranty claim will be refused if it is not sent back to the point of sale, or another place indicated by Studer Innotec, in appropriate packaging and accompanied by a copy of the dated proof of purchase.

No warranty claims will be accepted for damage resulting from handling, usage or processing that does not explicitly appear in this manual.

Cases of damage arising from the following causes are notably excluded from the warranty:

Inappropriate use

The presence of liquids in the device or oxidation resulting from condensation

Damage resulting from falls or mechanical shocks

The opening or alteration of the RCC remote control, carried out without the explicit authorisation of Studer Innotec

Damage due to atmospheric surge voltage (lightning)

Damage from transportation due to inappropriate packaging

LIMITATION OF RESPONSABILITY

The placement, commissioning, use, maintenance and servicing of the RCC remote control cannot be the subject of monitoring by Studer Innotec. For this reasons Studer Innotec assumes no responsibility and liability for damage, costs or losses resulting from an installation that does not conform to the instructions, defective functioning or deficient maintenance.

The use of Studer Innotec devices is the responsibility of the customer in all cases. This equipment is neither designed nor guaranteed to supply installations used for vital medical care nor any other critical installation carrying significant potential damage risks to people or the environment.

Studer Innotec does not assume any responsibility for the infringement of patent rights or other rights of third parties that result from using the devices.

The responsibility of Studer Innotec may not under any circumstances exceed the amount spent to purchase the product.

Studer Innotec reserves the right to make any modifications to the product without prior notification.

SAFETY INSTRUCTIONS

Carefully read the following safety instructions in order to avoid any injury or risk of damaging this product and those that are connected to it.

Only use the connection cable specified and supplied by Studer Innotec. Under no circumstances should you use a damaged cable. In case of doubt about the condition of this device, it should be inspected by a qualified technician.

Do not use the RCC remote control in a humid environment.

Do not use the RCC remote control in an explosive environment.

ACCEPTANCE OF THE SOFTWARE LICENCE AND UPDATES

By using the RCC remote control, you are accepting the terms and conditions of the following licence agreement. Please read this carefully.

Studer Innotec is granting a limited licence to use the software installed in this equipment in its executable binary format during the normal functioning of the product. The title, the property rights and the copyrights relating to this software, remain the property of Studer Innotec.

You acknowledge that the software is the property of Studer Innotec and that it is protected by copyright law according to the international copyright treaties.

You also acknowledge that the structure, organisation and software code are valuable commercial secrets belonging to Studer Innotec. You agree not to decompile, disassemble, alter or reverse either the unit or the engineering or make the software readable, irrespective of which part of the software, or to create any work whatever that is based on this software.

Studer Innotec

Updating must be done in the full awareness of the cause and is always the responsibility of the customer. Partial updates may cause ruptures in the compatibility or in its stochastic operation.

INTRODUCTION

Congratulations! The purchase of an RCC remote control offers you unlimited access to the various functions of the devices in the Xtender series. Numerous configurations that can now be accessed allow you to optimise the operation of the installation. Despite all these options, the Xtender works on a simple basis.

Different figure scenarios as well as associated configurations are presented at the end of this manual.

The manual for the RCC remote control is divided into several distinct parts:

The first part is devoted to the adjustments of the RCC remote control, whether this is the language used or the clock, which are sometimes necessary for the whole installation to work well.

The second part is concerned with immediate information on the installation. This gives access to the electric values such as the battery voltage, inverter load and many more.

The third part shows the functions for saving events occurring in the installation. This may be necessary for diagnosing a weakness or simply to check that the whole unit is working well during its whole service life.

The fourth part, which is more technical, presents various options for configuring the Xtender.

Do not change the configurations except when you have the technical knowledge; otherwise, the operation of the installation could at risk or installation itself could be partly damaged.

MODELS CONCERNED

The RCC remote control may be connected to any Xtender, the use of which is clearly detailed in its operating instructions.

CONTROLS AND INDICATORS

The RCC remote control is equipped with four operating keys as well as a graphic display with back-lighting. The function of the keys may change according to the context of utilisation and a reminder of the function in progress is given at the right of the display.

Generally the keys UP and DOWN are used to alter values or options relating to what is on the display and the two central keys are used to access, confirm or quit the item shown.

If the back-lighting function is activated, pressing one of the keys starts it up.



SD CARD

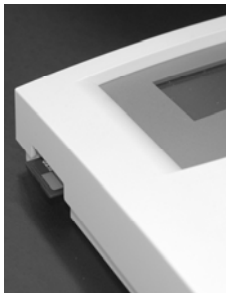

The RCC remote control is equipped with an SD (smart data)-type memory card reader. This card (not supplied) is used for various functions described in this manual. It allows, amongst others, the following functions: recording statistics, updates, backups or restoration of configurations or adjustments. The filing system used for the data is the FAT system. This card can be read using any standard SD card reader.

As far as the RCC-03 is concerned, the use of the SD card requires removing the remote control since

the access to the SD lies behind.



CONNECTION

The RCC-02 remote control must be firmly fastened using 3 screws on a flat support. The remote control RCC-03 is meant to be integrated. It must be mounted by means of 4 screws (not supplied) on a flat place without any mechanical constraints to the front plate. Once the RCC remote control is fastened it can be connected to the inverter using the authorised cable only. If the cable is damaged or if a socket is detached, the cable must not be connected since this can cause the whole installation to malfunction.

A maximum of 3 remote controls can be connected to one unit.

SERIES CONNECTION

To connect several RCC remote controls in series, you must activate termination at the two extremities on both units and deactivate it on the intermediate units.

Termination is activated on each Studer Innotec product by default.

- Activate the termination on each element of the series connection with a single cable.
- Deactivate the termination on each element of the series connection with two cables.

To deactivate the termination on an inverter or RCC remote control, turn the switch to the right.

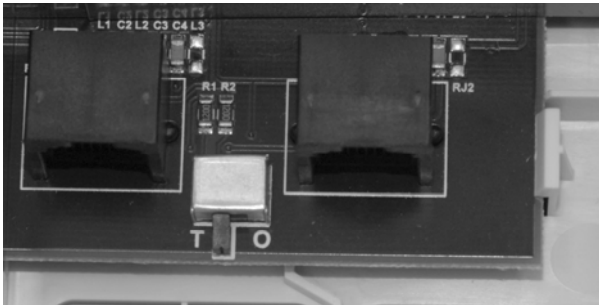

RCC-02 termination activated (position T)

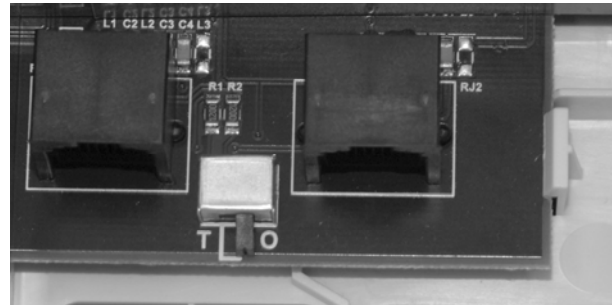

RCC-02 termination deactivated (position O)

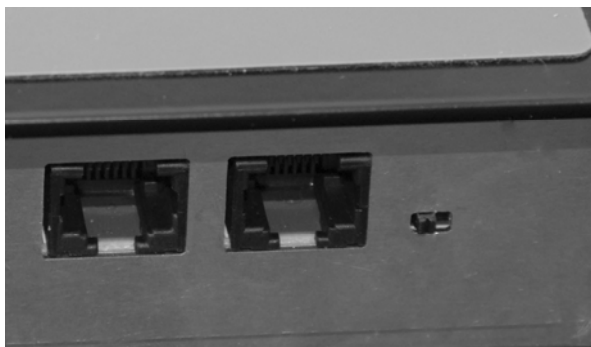

RCC-03 termination activated
(left position)

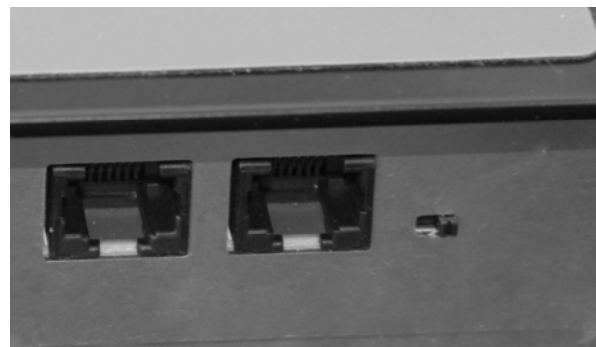

RCC-03 termination deactivated
(right position)

To activate the termination on the Xtender, move the two mini-switches to position T, and to deactivate it, move them downwards to position O.

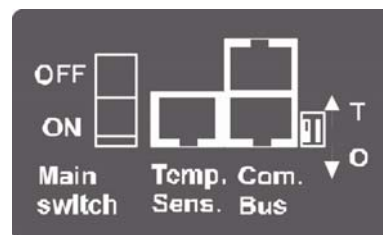

DIMENSIONS

RCC-02

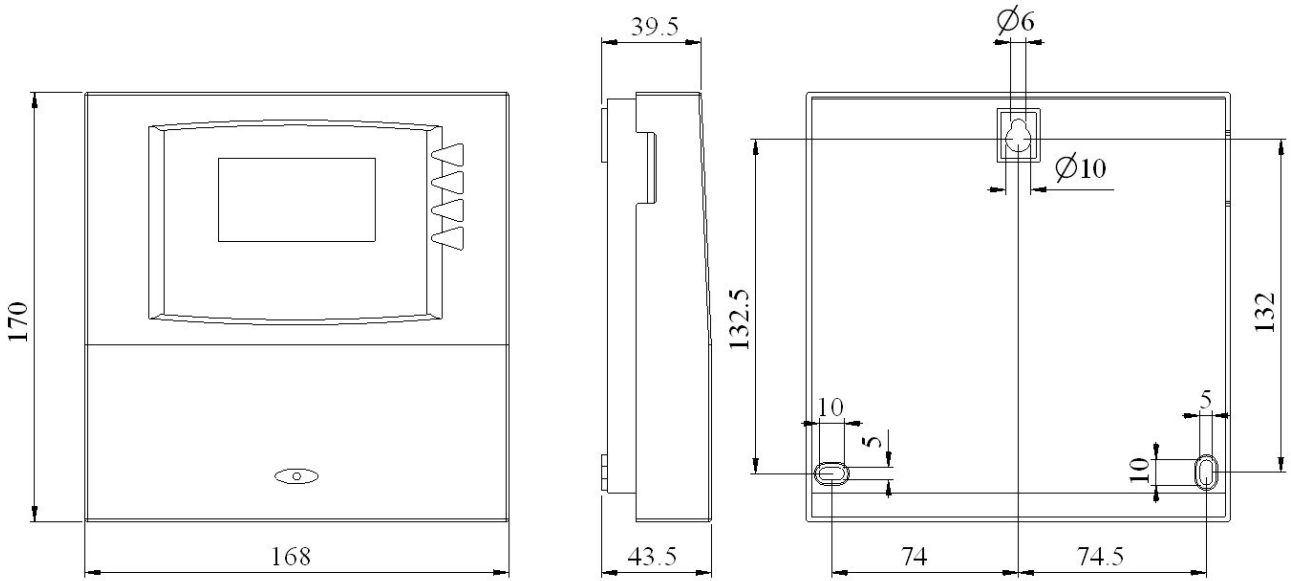

RCC-03

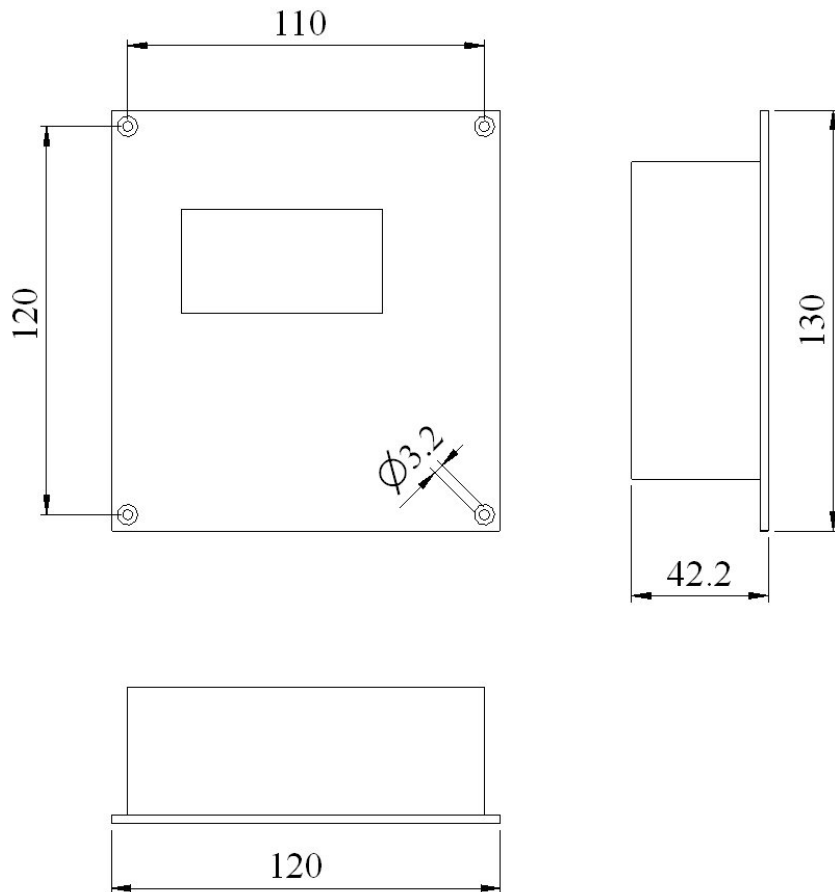

QUICK START GUIDE

The remote control RCC gives you access to a many settings possibilities. However, in most cases the setting of two parameters is required for the perfect running of your installation.

ADJUSTMENT OF THE LANGUAGE

To begin, set your remote control RCC for a display of the information in English.

The basic display is:

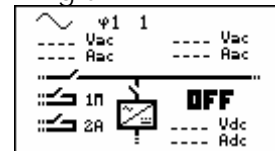

Press 2 times on the key "arrow downwards" to display the following screen:

Once beyond this screen you can come back to it by means of the key "arrow upwards".

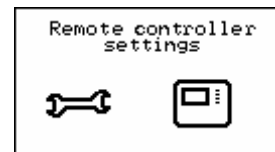

Press the key SET to enter the remote control settings. The screen of the language choice appears.

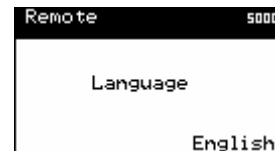

Press once more the key SET to modify the current language. The language then appears in reverse video.



With the keys "arrow upwards" and "arrow downwards" choose the language you wish. Then validate your choice by means of the key SET (OK).

We can now leave the setting of the remote control with the key ESC.

ADAPTATION TO THE SOURCE

It is a matter of indicating to the Xtender the power available to charge the batteries and to supply the users.

In order to adapt your installation to the source it is connected to, proceed as follows :

The basic display is:

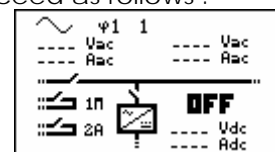

Press 3 times on the key "arrow downwards" to display the following screen:

Once beyond this screen you can come back to it by means of the key "arrow upwards".

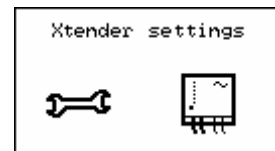

Press the key SET to access to the settings.

Then again on the key SET to access to the basic parameters.

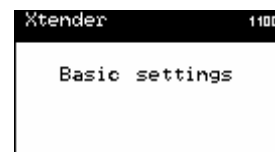

You can now adapt your installation to the source which it is connected to.
 Max. current of the AC source (power-sharing) {1107}.



i In case of using the Xtender on a public grid, it is actually the value of the circuit breaker on the source side (fuse or breaker).
 In a building, this value lies generally between 8 and 16A.
 In the case of a shorepower or of a camping terminal, it lies between 2 and 6A.

In case of using the Xtender on a genset, you can divide the genset power by the operating voltage (for instance for a genset of 3500VA, or 3500W, and 230V you get $3500/230=15.2$).

Caution: the powers given on the gensets are often overestimated compared to their real performances. To obtain a useable value it is necessary to multiply this result by 0.6 or 0.7 (in that case $15.2*0.7=10.64$).

Press the key SET to modify the value of this parameter (it appears in reverse video). By means of the keys "arrow upwards" and "arrow downwards" change the value to adapt it to your source and validate your setting with the key SET (OK).

ADAPTATION TO THE BATTERIE

Charge current {1138}

In order that your Xtender manages the best possible the energy stored in your batteries and that it charges them optimally, it is necessary to indicate the current which they can be charged with. You will find this value in the technical data provided by your batteries manufacturer.

i In the case of lead-acid batteries, one generally uses one tenth or one fifth of the battery capacity value.
 For instance for a 500Ah battery: $500/10=50A$ to $500/5=100A$.

The basic display is this one:

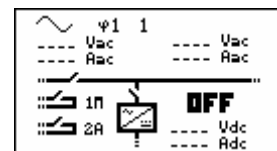

Press 3 times the key « arrow downwards » to display the following screen:

If you go overpass this screen you can come back to it by means of the key « arrow upwards »

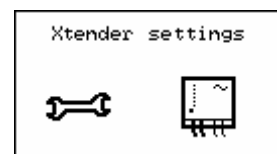

Press the key SET to access to the settings.

With the key "arrow downwards", access the menu "Battery and charger cycle".

Press the key SET to access this menu.

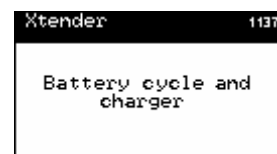

You are now going to set the charge current for the batteries:
 Press the key SET to modify the value of this parameter (it appears in reverse video). With the keys "arrow upwards" and "arrow downwards" change the value to adapt your battery and validate your setting with the key SET (OK).

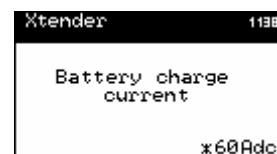

ACTIVATION OF THE FUNCTION SMART-BOOST

If your AC-In source is limited in power, the Xtender can work as a support and add the missing power for your loads.

First of all, check that you have adapted the Xtender to your source (see previous chapter: Adaptation to the source {1107})

The basic display is the following:

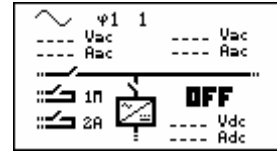

Press 3 times the key « arrow downwards » to display the following screen:

If you go overpass this screen you can come back to it by means of the key « arrow upwards »

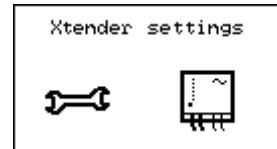

Press the key SET to access the settings.

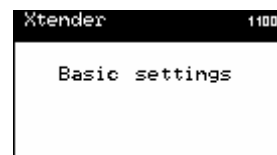

Then again the key SET to access the basic parameters.



Press the key DOWN to access the following parameter: the menu of disabling. Then again the key SET to get to the menu.



Go down with the key DOWN until the function Smart-Boost authorization parameter {1126}.

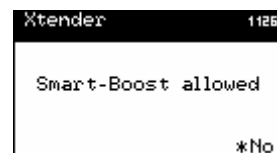

You can now authorize the function. Press the key SET to access this parameter in modification mode, then the keys UP or DOWN to change the option. To end up, validate with the key SET.

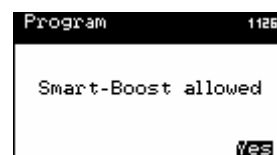

BASIC DISPLAYS

When the remote control is connected to an Xtender, it is possible to access different display menus divided into distinct categories.

Real time information displays on the operating mode of the installation

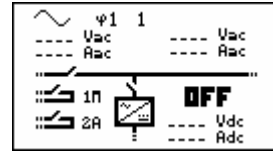
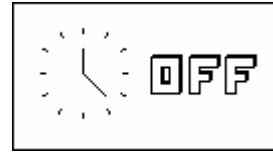

The history of events occurring in the installation



Adjustment of RCC remote control options

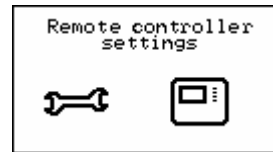

Adjustment of configurations on the Xtender(s)

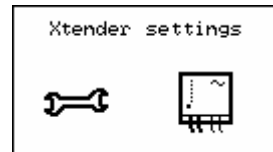

Information on the system

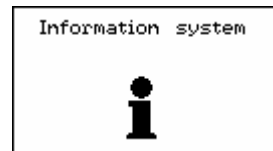

To go from one display to the other, use the keys UP and DOWN on the RCC remote control.

To visualize or modify the options of one of the basic displays, press the key SET when this one is displayed.

In the case of a system in 3-phase or in parallel, the following displays are available too:

Real time display of information on the state of running of the installation.

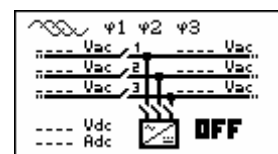
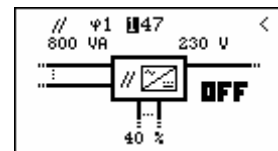

ACTIVATING AND DEACTIVATING THE COMBI XTENDER

When one of the displays is visible, it is possible to activate or deactivate the Xtender. To do this, simply press the key ESC. The key request on the screen indicates whether you are going to activate or deactivate the unit.

Once the key has been pressed, you must confirm your choice using the key YES. If you do not want the action to be carried out, it can be cancelled by pressing the NO key.

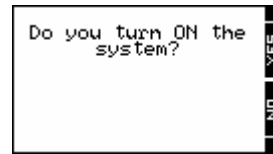

Note: This is a comprehensive signal and leads to the stoppage or starting of all Xtenders connected to the remote control.

ADJUSTMENT OF THE RCC REMOTE CONTROL

This screen gives you access to the remote control basic settings. From one of the basic menu items, use the keys UP and DOWN until reaching the item "Adjustment of the remote control", then confirm using the key SET.

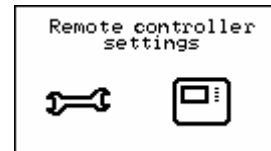

When the item to be modified appears on the screen, press the key SET to be able to modify it. This value then displays in inverse video. Now use the keys UP and DOWN to modify it. Once the correct value has been obtained, confirm by using the SET key or exit without modifying using the key ESC.



Each configuration has a unique ID displayed top right (see example below) these numbers are indicated between curly brackets in this manual : {xxxx}

EXAMPLE to modify the current date

Go to the following screen using the UP and DOWN keys.
Press the key SET to access the remote control adjustment.

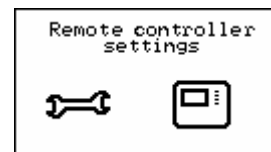

Go to the following screen using the key DOWN.
Press the key SET to modify the configuration

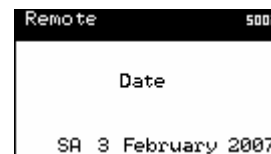

Set the correct date using the keys UP and DOWN
Go to the adjustment of the month using the key SET
Also set the month using the keys UP and DOWN
To complete, go to the year adjustment using the key SET
After having adjusted the year using the keys UP and DOWN, confirm using the key SET.



ADJUSTMENT OF THE LANGUAGE {5000}

The default language is English and the Xtender can store up to four languages simultaneously. This configuration allows you to choose one of them.

ADJUSTMENT OF DATE {5002} AND TIME {5001}

The Xtender has a perpetual calendar and an internal clock powered by a backup battery. The correct adjustment of the date and time allows accurate recording of events occurring in the installation as well as correct use of time-related functions, e.g. the disabling of the auxiliary relays during the night.

ADJUSTMENT OF THE CONTRAST {5006}

The adjustment of the contrast allows the display to be adjusted in terms of lighting and to a reading position that allows excellent visibility.

ADJUSTMENT OF THE BACK-LIGHTING {5007}

Back-lighting always off {5008}

This adjustment allows you to activate or deactivate the back-lighting. Its activation gives access to an additional configuration that is the duration of the back-lighting.

Studer Innotec

Duration of the back-lighting {5009}

This configuration allows you to determine after how much time of inactivity the back-lighting will switch off.

Red back-lighting if the Xtender is OFF and if there is a fault {5026}

If the Xtender is stopped by a fault (battery undervoltage, overload, etc.) the back-lighting flashes red.

INACTIVITY PERIOD BEFORE RETURNING TO THE STANDARD DISPLAY {5010}

This configuration allows you to determine the time after which the display returns to the basic display if no key is pressed.

DURATION OF DISPLAY FOR QUICK MESSAGES {5011}

Messages of low importance are displayed for a limited period. This adjustment enables you to adapt this duration at your convenience.

ACOUSTIC ALARM {5027}

In the event of an alarm an acoustic signal is activated. You can always deactivate this signal by using this configuration.

USER LEVEL {5012}

The adjustment of the user level allows you to choose the access to the Xtender according to your level of expertise.

The INFO ONLY level may be selected by entering the code 460081. This level does not allow the Xtender configurations to be modified, it only allows information to be displayed on the system.



Use the INFO ONLY level after adjusting the configurations if the remote control is located in a public place or if it is accessible by people who are not authorised to carry out adjustments on your system. You may change the level at any time to make new adjustments, by entering the appropriate code.

The BASIC level allows you to configure basic Xtender functions, limiting the field of actions to simple configurations. Please note that the incorrect adjustment of basic configurations may lead to the malfunctioning of the installation. This level is selected by default. To return to this level after a change, enter code 943274.

The EXPERT level allows access to more complex Xtender configurations and this level of usage may only be used with extensive specialist knowledge. To access the expert level, enter code 426468.

DRIVE THE REMOTE CONTROL TO THE USER LEVEL BASIC {5019}

You can with this option bring the remote control back to the level "user Basic".



Use this function at the end of the system setting to go out of the EXPERT mode.

BACKUP AND RESTORING {5013}

The different options of this menu allow you to do a safety backup of your system or various actions in relation to the SD card.

Backup of statistics {5014}

Backup the data on the operation of your Xtender(s) using the SD card. The data are written into a file in CSV format, which can be reread in practically all spreadsheets and word processing

programs. The file is written in a directory called STATS and in a subdirectory which indicates the date of backup.

Backup of remote control configurations {5015}

This function writes useful configurations for the operation of the remote control on to the SD card. You can use this function to do a backup of the remote control parameters or to visualize on a computer the values that you have selected.

The file in CSV format is written in a directory called CSVFILES\« FID »\DATE.

The directory FID indicates the unique identification of your remote control and contains the subdirectory which indicates the date of backup.

Backup of Xtender configurations {5017}

This function writes the operational configurations on to the SD card of the Xtender. You can use this function to do a backup of the remote control parameters or to visualize on a computer the values that you have selected.

The file in CSV format is written in a directory called CSVFILES\« FID »\DATE.

The directory FID indicates the unique identification of your Xtender and contains the subdirectory which indicates the date of backup.

Loading the remote control configurations {5016}

Reload the remote control configurations. If several files have been created with different remote controls, the loaded file is the one that corresponds to the remote control being used. If the parameters have been backed-up several times at different dates, the last backup will be loaded.

Loading the Xtender configurations {5018}

Reload the Xtender configurations. If several files have been created with different Xtenders, the loaded file is the one that corresponds to the Xtender being used. If the parameters have been backed-up several times at different dates, the last backup will be loaded.

Loading a master file {5034}

If your installer provides you with a file of parameters for your installation, you can load it by means of this menu. Insert the SD card and launch the loading by pressing the key SET. Caution, the various operations carried out by this process take some minutes.

Separator of the csv files {5032}

This option allows you to choose the field separator for the csv file. As per the operating system and the language that you are using, the separator must be adapted in order to be correctly interpreted. In the case of systems in English, the comma (,) is normally used.

INFORMATION ON THE OPERATING MODE OF THE INSTALLATION

There are two different views for displaying information on the system :

A simplified and a configurable display. When one of these two displays is visible, it is possible to activate or deactivate the system. For further information, please refer to the paragraph on activating and deactivating the combi Xtender.

The simplified display only indicates the current time and the mode of the Xtender (ON or OFF)

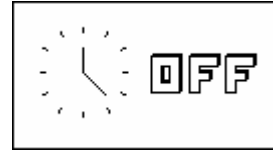

The configurable display shows the system in its entirety, represented by a synopsis of distinct information blocks.

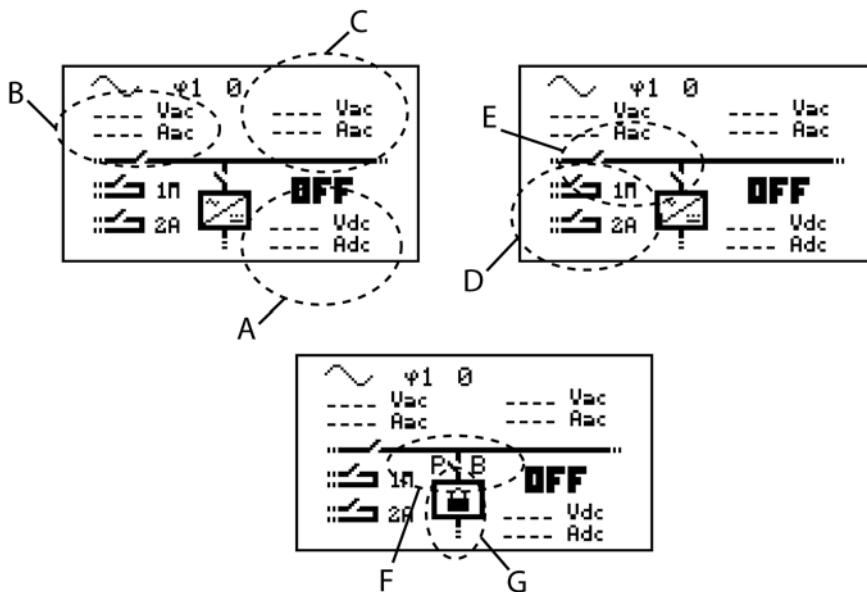

- Information on the battery (A)
- Information on the grid input (B)
- Information on the grid output (C)
- Information on the auxiliary contacts (D)
- Information on the transfer and output relays (E)
- Information on the power sharing mode of the smart boost (F)
- Information on possible locking of the function (G)

Two pieces of information related to blocks A, B and C may be viewed simultaneously. To change displayed information, proceed as follows:

Press the key SET (one of the pieces of information is displayed in inverse video).

Go to the value to be changed using the UP and DOWN keys.

Enter into modification using the key SET. You may now view the values that can be displayed in this area.

Using the keys UP and DOWN, select the new information that you want to appear.

Confirm your selection using the key SET.

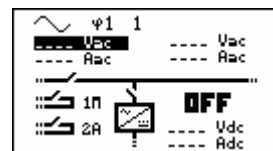

To escape at any time, use the key ESC to return to the starting display.

The following information is available:

With regard to the grid input

- AC In input voltage
- AC In input current
- AC In input power
- Input frequency
- Energy from AC-In of the previous day
- Energy from AC-In of the current day

With regard to the grid output

- Output voltage
- Output current
- Output power
- Output frequency
- Consumers energy of the previous day
- Consumers energy of the of the current day

With regard to the battery

- Battery voltage
- Actual charge current of the batteries
- Programmed charge current
- Ripple voltage of the batteries
- Charging phase (bulk charge, absorption, float charge, etc.)
- Dynamic compensation of the battery (compensation of the thresholds due to the internal resistance of the battery)
- Operating mode (inverter, charger, etc.)
- Battery temperature (if a sensor is present)
- The battery temperature's inherent compensation (if a sensor is present)
- Discharge of battery of the previous day
- Discharge of battery of the current day

If a piece of information is not available, the screen displays - - - -.

Information on the auxiliary relays as well as the output and transfer relays appears as open or closed in the synopsis according to their current state.

Auxiliary relays are indicated with their corresponding number as well as the letter A if they are operating in automatic mode and M if they are controlled manually.

Other letters may be displayed with regard to specific programming. Please refer to the corresponding chapter.

The general operating mode of the combi Xtender is displayed in large letters on the two visualisation screens (ON or OFF).

DISPLAY OF THE PARALLEL AND THREE-PHASE SYSTEMS

While using several Xtenders in parallel or in three-phase, an additional view is available. This view summarizes the various electrical values of the system. Like for the display of a system with one single Xtender, you can access to the displayed values in order to modify them.

Each summarized view gives access to the display of one Xtender.

In the view of the three-phase, you have access to the detail of one phase by pushing the key SET and then, by pushing UP or DOWN, you can choose the phase you want to see displayed in details.

If the phase consists of several Xtenders in parallel or if the system is a single phase one but with several Xtenders in parallel, you can then have access to the display of each Xtender by selecting in the view parallel one of the three available inverters.

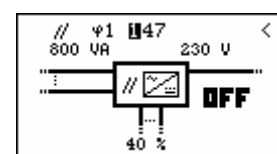
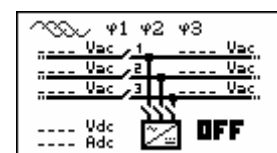

EVENT HISTORY

This screen allows you to view the various events that have occurred in the installation.



The events that occur in your installation are displayed on the remote control screen. The events are classified within two categories:

- The events that may have serious consequences are displayed up to the moment where the user confirms that he has taken note of them by pressing on an RCC remote control key. These events are recorded in the event history and may be consulted subsequently.
- Events not posing a risk are indicated briefly on the display and then disappear. Some are recorded in the event history and others are not (see the list of elements stored further on).

On the other hand, the messages may have different origins and they are preceded by an attribute to enable you to understand the importance:

Message : normal event but one that conditions or influences the operation of the Xtender.

Error: an event that prevents the correct or normal operation of the Xtender.

Alarm: an event that may cause a malfunction of the installation if it is not corrected.

Stop: The system had to be stopped as a major event is preventing its operation.

ALARM LOW BATTERY VOLTAGE

The battery is almost completely discharged. If the situation persists, the inverter function of the Xtender will be deactivated.

Solution: Recharge your batteries more frequently or increase the power available for charging (e.g. with more solar generators).



This message is generated in conjunction with the undervoltage of the battery configuration {1108} and not with acoustic alarm {1196}.



The service life of the batteries is greatly conditioned by their state of charge. Prolonged or repeated operation at a low charge may cause damage. With the smart boost function activated, it is also possible to discharge the batteries even if connected to a source of energy.

STOP BATTERY VOLTAGE TOO LOW

The Xtender inverter and boost functions are deactivated since the batteries are discharged.

Solution: Recharge your batteries to automatically reactivate these functions.

STOP HIGH BATTERY VOLTAGE

The battery voltage present on the Xtender is too high. The system is stopped for safety reasons.

Solution: Check that the rated voltage of the battery conforms to that required by your Xtender.

Where an external charger is being used, check that this is charging the batteries at a voltage admissible for the Xtender.

MESSAGE AC IN SYNCHRONISATION IN PROGRESS

A valid voltage has been detected on the AC IN input and the Xtender is synchronising. Once synchronised, the consumers will be transferred to it and the battery will be charged.



Note: It is possible to prohibit the transfer or the battery charging.

ERROR INCORRECT INPUT FREQUENCY

The voltage at AC IN does not have a frequency included in the admissible range for the Xtender.
Solution: When operating on a generator, check its speed.



If you are not equipped to measure the generator frequency, measure its voltage with no load. Indeed, if the voltage is correct, the frequency is generally correct as well.

ERROR INPUT VOLTAGE TOO HIGH

The voltage at the AC IN is too high for the Xtender and represents a danger for the consumers; the transfer relay is not activated.

Solution: Reduce the voltage on the AC IN input to come into an admissible range.

ERROR INPUT VOLTAGE TOO LOW

The voltage at AC IN is too low for the Xtender. The transfer of consumers and battery charging are not activated.

Solution: Reduce the voltage on the AC IN input to come into an admissible range.



Do not increase the voltage of the generator during the battery charging or when the consumers are connected to it: If the consumers stop, an overvoltage may arise which will destroy components of your installation.



If the transfer of the consumers is carried out and the message appears some seconds after the start of the battery charging, check that you have not adjusted the charging voltage of the batteries too high in relation to your source. Also check the adjustment of the power sharing configuration.

STOP INVERTER OVERVOLTAGE

The consumers require more power than the Xtender inverter can supply.

Solution: Adapt the maximum power output of your consumers to the maximum power output of the Xtender.

STOP OVERTEMPERATURE

The Xtender stops due to overheating.

Solution: Adapt the maximum power output of your consumers to the rated power output of the Xtender.

Check that the ventilation holes of the Xtender are not obstructed.

Check that the Xtender is not situated in a place where the ambient temperature is too high.



The overtemperature is disadvantageous for the service life of certain electronic components. If the stoppages due to overtemperature happen frequently, corrective measures will be required.

STOP EXCESSIVE BATTERY VOLTAGE RIPPLE

The Xtender is stopped as the voltage ripple at the battery cables is too high.

Solution: Check that the battery cable section is correct.

Check the tightness of the battery cables.

Check that the charge current matches your battery.

Check the state of your batteries.



The use of batteries of an inappropriate capacity may also cause this error message. In this case, reduce the charge current or lower the power output of the consumers.



The voltage ripple on the batteries may be caused by their ageing. In this case, lower the charge current.

MESSAGE POWER SHARING EXCEEDED; TRANSFER PROHIBITED

The power output of the consumers exceeds the one specified for the source, and the transfer relay cannot be activated. The Xtender operates in inverter mode.

Solution: Check that the configuration of the maximum current for the source corresponds to the maximum current of the source connected at AC In.

Reduce the number or power output of the consumers.



In this case, the transfer relay is not activated and the recharging of the batteries cannot take place. If this situation continues, you risk discharging your batteries.

ERROR VOLTAGE AT AC OUT

An unwanted voltage is present at AC Out.

Solution: Check the installation cabling. No source should be connected to the Xtender output (AC Out).

ERROR PHASE NOT DEFINED

The Xtender cannot operate without the phase being defined.

Solution: Check the phase definition jumper in the cable connection zone.

Refer to the Xtender manual for more information.

STORED EVENTS

Events are stored in the remote control. Any system not permanently connected to a remote control does not store the events.

- Disconnection due to inverter overload
- Disconnection due to battery overvoltage
- Disconnection due to battery undervoltage
- Disconnection due to Xtender overtemperature
- AC In voltage too high
- Bulk charge too long (risk of short-circuited element)
- Battery voltage ripple too high (charge current too high for the battery used)
- Voltage at AC Out
- Results of the autonomy tests
- Overrunning of the power source and transfer relay opening

To access the event history via one of the basic displays, change the screen using the keys UP and DOWN until the "event history" screen appears and then validate using the key SET.

The number shown at the top right indicates the message number. In a system with several Xtenders, the events are presented in chronological order and the lower line indicates the Xtender to which the event refers.

Each event is recorded as well as the date and time of its occurrence. The keys UP and DOWN allow you to view all the events that have occurred.

Where there is a system with multiple Xtenders, each message also contains the number of the Xtender that has generated the message.

Quit the message display using the key ESC.



ADJUSTMENT OF THE COMBI XTENDER

GENERAL

The Xtender inverter/charger has been designed to ensure that all basic functions of an energy management system work completely independently. In its original version, no adjustment is usually required.

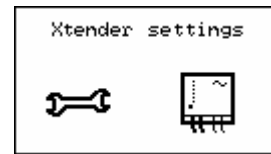

Nevertheless, in certain installation conditions, it may be necessary to adjust some operating configurations. This is why the RCC remote control gives access to the adjustment of many configurations and within a range largely exceeding the usual values. Use these adjustment options with care and only with due specialist knowledge. Changing configurations is not the responsibility of Studer Innotec. Please refer to the chapter on limitation of responsibility for more information on this topic.

CONFIGURATION ON A SYSTEM WITH SEVERAL XTENDERS

When there is a system to which several Xtenders are connected, the changing of a configuration is global. It will be applied to all the Xtenders connected together. To carry out adjustments on a single Xtender, it is necessary to remove the connection cables and only keep the connection between the remote control and the Xtender on which the different adjustment is being carried out. It is thereby possible to configure each Xtender of a system independently. Once the configuration has been carried out, the original connection can be re-established.



Note: If you have carried out an individual configuration, once a configuration has been changed, the system reconnected by the data connection cable modifies this configuration for all the Xtenders connected.

UTILISATION AND ACCESS LEVELS

The functions described below refer to the EXPERT level. Depending on the user level selected, access to all the functions may not be possible. Refer to the chapter on adjusting the user level of the remote control for more information on this subject.

PRE-DEFINED FUNCTIONS OF THE AUXILIARY RELAYS

The two auxiliary relays (dry contacts) of the inverter-charger Xtender are already programmed with factory settings and can be activated with various functions. They react to different signals. The factory settings depend on the Xtender models. For more information on the auxiliary contacts pre-set functions, please see the inverter-charger Xtender manual.



Caution, if your installer or supplier has done pre-settings, these pre-set functions may have been changed. To check the different programmings, use the function backup of the Xtender parameters on the SD card, described there above in this manual.

MENU

The Xtender configurations are divided into several categories:

- Basic configurations
- Battery and its charge cycle configurations
- Inverter configurations
- Combi configurations (inverter/charger)
- First auxiliary contact configurations
- Second auxiliary contact configurations
- Auxiliary contact extended function configurations
- Three-phase or parallel operation configurations

Studer Innotec

According to the user level selected, it is possible to access several hundred configurations. For this reason, each configuration has a unique ID displayed top right. In the event of questions on the subject of a configuration, ensure that you have this number at hand.

When you modify a configuration, a star is displayed to the left of the value if it corresponds to the factory-set value.

The various configurations can be adjusted within a large range. Nevertheless, some configurations are interdependent and cannot be adjusted beyond the value of other configurations. You can consult the list of dependencies on the list in appendix 1.

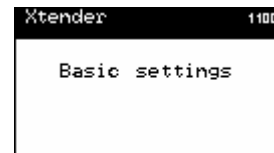

Basic configurations {1100}

The basic configurations serve to adapt the Xtender characteristics to the elements that surround it. Use these configurations in order to optimise the operation of the inverter/charger and to benefit from the maximum performance of your installation.

Maximum current of the AC source (power sharing) {1107}

Adjust this configuration in the event of connection to a limited power source, for example, a generator of moderate power output or a dock or camping connection. The adjustment of this value limits the instantaneous power consumed from the source in charger mode. The power available is attributed by first priority to consumers and then to battery charging. If the consumption level changes, the battery charge current is automatically adjusted.

- A. Power available and used to recharge the batteries
- B. Maximum AC source current (adjusted to 10 A here)
- C. Consumer current
- D. Power supplied by the inverter (smart boost function)

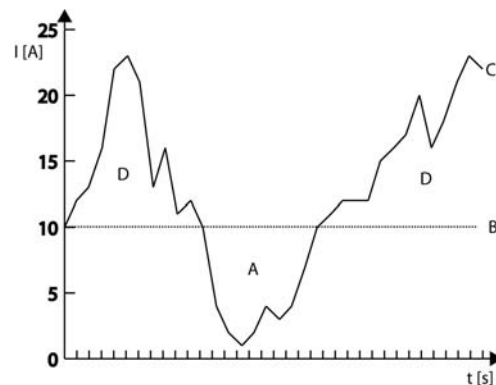

If the consumption level is higher than the controlled level, the maximum source current will be exceeded, except when the smart boost function is activated.

Locking {1123}

In certain cases it may be useful to deactivate the Xtender functions to obtain specific behaviour. Different possible locks may be accumulated in order to refine the system operation.

Where there is lock on the inverter, charger or transfer function, a small padlock is displayed on the configuration display.

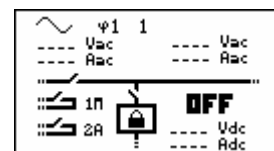

Authorised inverter {1124}

This configuration authorises operation in inverter mode. If the inverter is deactivated, a voltage will be present on the output terminals (AC OUT) only if a correct voltage is present at the input (AC-in) and the transfer is not prohibited.



This function can be used for supplying non-critical consumers while ensuring that the battery is not discharged even if the source is faulty.



Note, that if the smart boost function is activated, it is possible to discharge the battery even if the inverter function is locked.

Authorised charger {1125}

The battery charger function is either activated or not. If this function is not authorised, it is necessary to charge the batteries using a source of energy not connected to the Xtender.

Smart boost authorised {1126}

The function Smart-Boost is deactivated by default. In this case no assistance will be provided to the source and if the source is overloaded, the energy from the battery is not drawn. Do authorise this function if you have a low power source (generator, shore power or camping plug) and you want more power available.



When the smart boost function is active, it is possible to discharge the batteries, even if the Xtender is connected to a source and the charger is active.

Authorised transfer {1128}

The transfer relay is authorised or not. If the transfer is not authorised, a correct voltage at the AC IN input will not be transferred to the output and to the users. The battery charger function is not possible and the Xtender operates only in inverter mode.

Automatic restart {1129}

In the event of an anomaly on the installation, the combi Xtender stops automatically. Depending on the seriousness of the fault, when this disappears, the Xtender may restart automatically without any user intervention (fault confirmation). The following functions allow the events for automatic restart to be defined.

- After battery undervoltage {1130}
- Number of battery under voltages allowed before final stop {1304}
- Leadtime to counting the battery under-voltages allowed before final stop {1404}
- Number of critical battery under-voltages before final stop {1305}
- Leadtime to counting the critical battery under-voltages allowed before final stop {1405}
- After battery overvoltage {1131}
- After inverter or smart boost overload {1132}
- After overtemperature {1134}



Whatever the restart method, the event is recorded in the event history so that it can be called at any time.

Number of battery under-voltages allowed before final stop {1304} and

Leadtime to counting the battery under-voltages allowed before final stop {1404}

If battery under-voltage faults occur to your system, the inverter and Smart-boost functions are deactivated in order to protect the battery against deep discharges.

These functions can be reactivated automatically if the fault disappears. With the parameter {1304}, you can adjust the number of the faults before these functions are definitely deactivated. In this case, an intervention is necessary to reactivate these functions (fault acknowledgement).

The duration parameter allows setting the time during which these faults can be repeated.

Once this duration has come to an end, if the number of faults is not reached, the counter goes back to 0 and the faults can occur again.



To cancel the automatic reactivation, set 1 for the number of battery under-voltages allowed before final stop.
For a permanent automatical reactivation, set 0.

Studer Innotec

Number of critical battery under-voltages before final stop {1305} and

Leadtime to counting the critical battery under-voltages allowed before final stop {1405}

The critical battery under-voltages can also be automatically acknowledged in case of undervoltage disappearance. Like for the under-voltages (see previous paragraph) you can adjust the number of restarts of the inverter and Smart-boost functions once the fault disappears.

Restore default configurations {1395}

Use this function to re-establish the original combi Xtender adjustments.



If your installer has carried out settings while commissioning your installation, this function brings back these settings and not the factory settings.

Battery cycle and charger {1137}

These configurations are intended to adjust the battery charge cycle to the data supplied by its manufacturer. The basic battery cycle is described in the Xtender manual.



Caution : the Xtender charger is meant only to the charge of lead batteries.



Note: Incorrect values may lead to early ageing or even the destruction of the batteries.

For further information, contact your battery supplier who will give you the correct values. The graphic presentation of the battery cycle shows the options for linking the various phases:

Minimum battery cycle

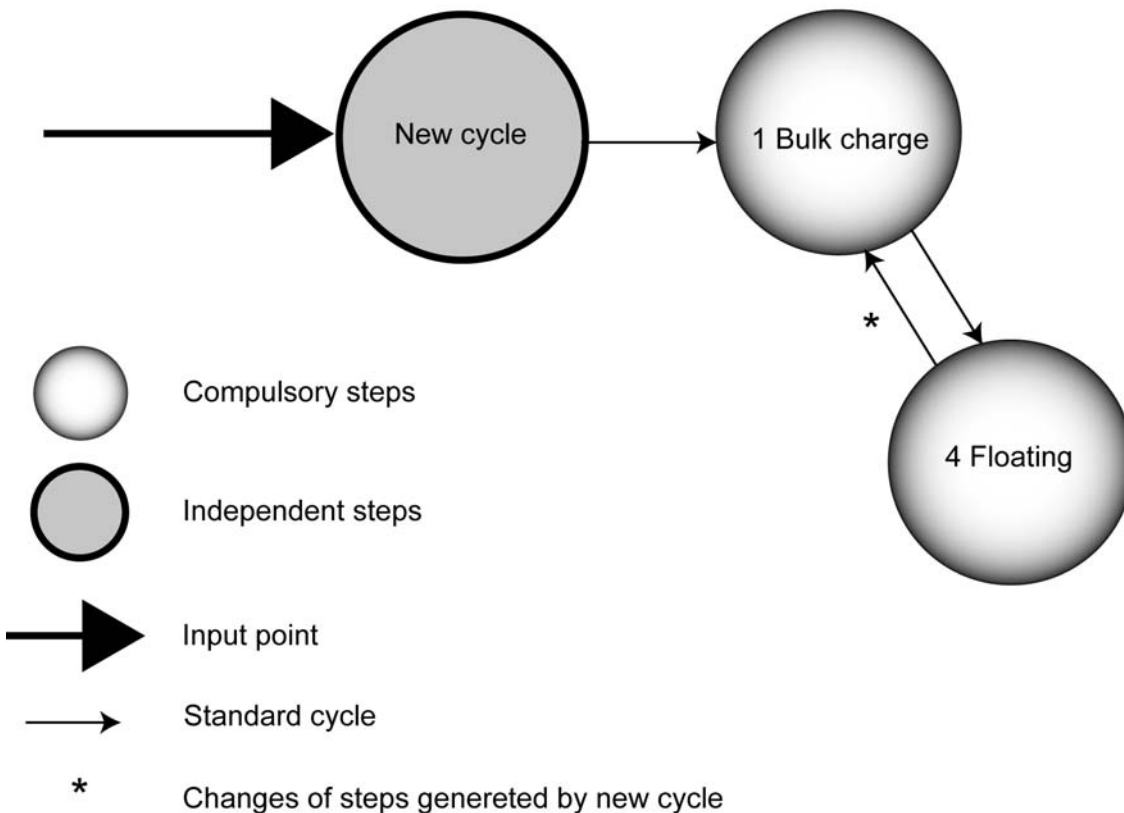

The bulk charge and floating phases cannot be deactivated. If the conditions for starting a new battery charge cycle have come together, the bulk charge phase starts immediately.

Default battery cycle

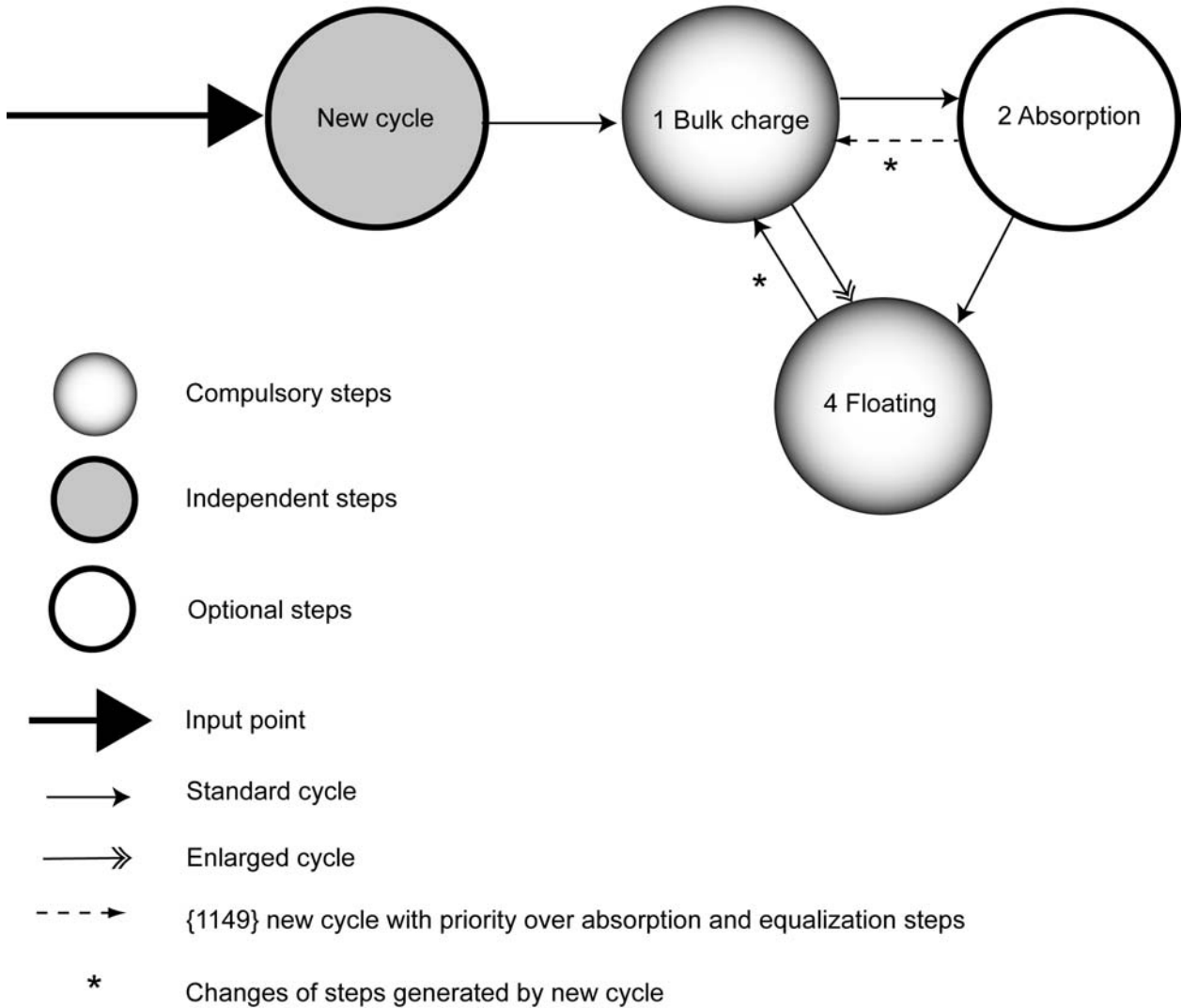

The battery cycle fits a large number of batteries by default, irrespective of whether they are gel batteries or not.

Complete battery cycle

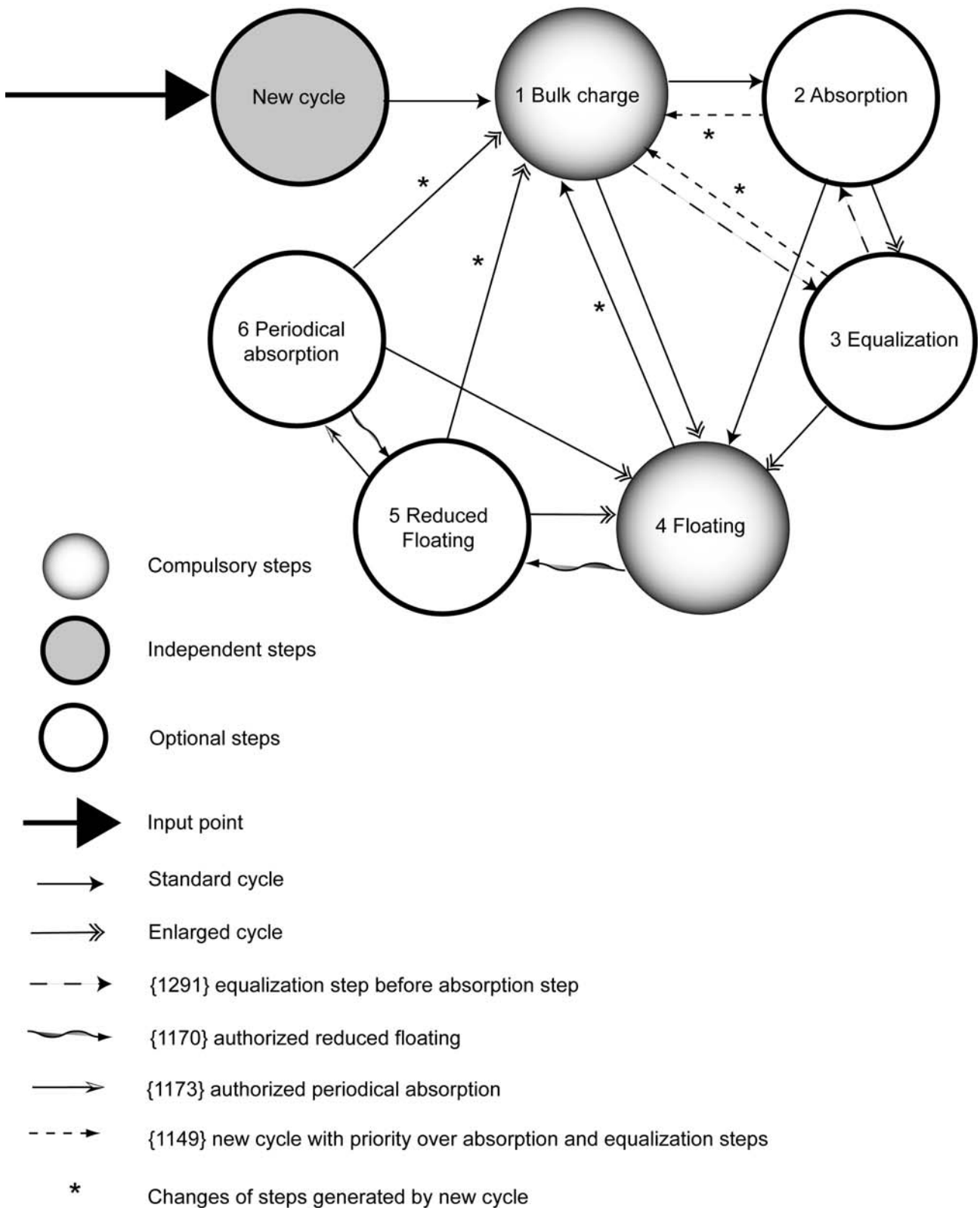

Charge current {1138}

Use this value in order to adapt the charge current to the battery. With this configuration, the maximum current to be used for charging your battery is adjusted. The current appropriate for the battery can be found in its technical data. The value set by this configuration is used during the whole bulk charge phase.



Use this setting to adapt the charge current only with regard to the battery. To adapt the charge current to your source, use the parameter for maximum current at the source (power sharing) {1107}.
The right setting of these two values is essential for correct operation as well as the lifetime of your installation.

Temperature correction coefficient {1139}

If a battery temperature sensor is used, the charge and discharge voltages are automatically adapted to the temperature of the batteries. The compensation is given in millivolts by degree Celsius (°C) and by battery cell.

Battery maintenance voltage (floating) {1140}

Use this configuration to adjust the voltage that will be used when the battery is completely charged. This voltage prevents automatic discharging and maintains the battery at its maximum level of charge.

Force passage to floating mode {1467}

This configuration may be used to force a battery cycle in progress and to bring it to the end of charge values. If the battery voltage level is higher, the charger is temporarily disconnected. If the battery level is lower, the charging current is increased up to the maximum in order to reach the set level as quickly as possible.

New cycle {1141}

Battery charging is a complex function that generally ends with a maintenance phase (floating) of indeterminate duration. The configurations below allow adjustment of the conditions that lead to the starting of a new charge cycle.

Force new cycle {1142}

This configuration allows a new charge cycle to be forced, and the bulk phase follows straight away.

Voltage 1 for a new cycle {1143} and Duration at undervoltage 1 for a new cycle {1144}**Voltage 2 for a new cycle {1145} and Duration at undervoltage 2 for a new cycle {1146}**

The battery voltage value, below which a new cycle is started, can be specified. The battery voltage must remain below this threshold for the duration that is also to be determined. Two voltages associated with two durations are configurable. Generally, a higher voltage is used with a longer duration and a lower voltage with a shorter duration.

New priority cycle on the absorption and equalization phases {1149}

Activate this configuration to accept or interrupt the absorption and equalization phases to start a new cycle. In the opposite case, even if the conditions are fulfilled for starting a new charge cycle, the battery charging proceeds normally by following the programmed phases.



In the event of battery charging with renewable energy sources such as solar energy, for example, this configuration must remain deactivated (*no) in order to avoid cycles taking place too frequently.

Studer Innotec

Absorption phase {1451}

During this phase, the battery accumulates the final percentages of the energy it is storing. This phase is carried out with a constant voltage.

Authorised absorption {1155}

This configuration determines whether or not the absorption phase is used. If this phase is deactivated, the charger goes directly to the authorised phase that follows it.

Absorption voltage {1156}

Use this configuration to adjust the voltage that is used for the absorption phase.

Duration of absorption {1157}

Use this configuration to adjust the duration of the absorption. The absorption phase starts once the set voltage {1156} is reached. When the duration has run out, the charger automatically goes to the authorised phase that follows it.

Completion of absorption released by the current {1158}

The absorption phase may be interrupted if the battery charge current automatically passes below a certain threshold. This may be used in order to limit the duration of the operation of a generator while there is an acceptable battery charge.



During the absorption phase, as a matter of fact, the charge current reduces progressively. If the bulk charge has been carried out with a current correct for the battery, it is not necessary to adhere to a fixed duration to end the charging.

Current at end of absorption {1159}

Set the current value below which the absorption phase is considered to be at an end. When the current of the charger goes below this value, the next step starts.

Equalization phase {1452}

Certain types of battery require equalization in order to avoid the stratification of water and acid that they contain. Use the configurations below in order to adjust the usage conditions for this charge phase.



During an equalization phase, a large quantity of gas is released that is highly explosive (hydrogen). Ensure that you adhere to the battery manufacturer's instructions for this function. In all cases, ensure that there is sufficient ventilation around the batteries.



During the equalization phase, the water of the battery is separated into gases (hydrogen and oxygen) and this action serves to decrease the level of liquid in the batteries. Check their level regularly.

Start equalization {1162}

Use this configuration to force the start of an equalization phase.



It is only possible to force an equalization phase if the equalization is authorised. Once the phase has started, prohibiting the phase does not stop the equalization. To stop the equalization, use Force passage to maintenance (floating) or Force new cycle.

Authorised equalization {1163}

This configuration determines whether or not the equalization may be used on the installation.

Equalization before absorption phase {1291}

This configuration determines in the charge cycle, in which equalization will be activated, if the equalization is carried out after or before the absorption phase. The equalization phase is carried out before the absorption phase by default.

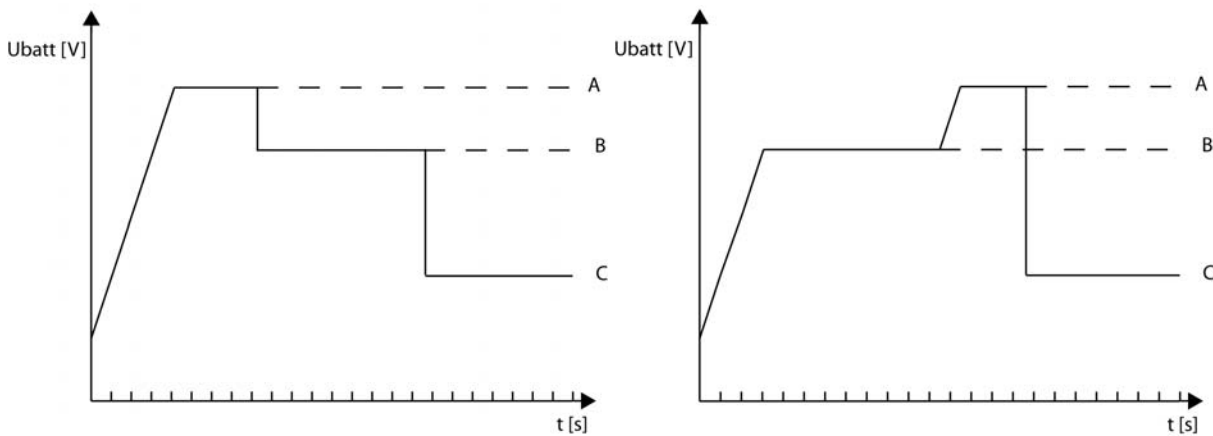

- A. Equalization
- B. Absorption
- C. Floating

Equalization current {1290}

The equalization phase can be carried out with a limited current, which can be adjusted using this configuration. In all cases the current does not exceed that of the bulk charge phase {1138}

Equalization voltage {1164}

Set the voltage at which the equalization is carried out using this configuration.

Duration of equalization {1165}

Use this configuration to adjust the duration of the equalization. The equalization phase starts once the set voltage {1164} is reached. When the duration has run out, the charger automatically goes to the authorised phase that follows it.

Number of cycles prior to equalization {1166}

Equalization is not carried out at each charging cycle. This configuration allows the number of charging cycles to be adjusted where equalization is not active.

Equalization at set intervals {1284}

In the event of usage with few charge cycles, it may be necessary to carry out equalization cycles at set intervals and not with a number of set cycles. If this configuration is activated, a new battery charge cycle with an activated equalization phase with the programmed interval is started {1285}.

Weeks between equalizations {1285}

Use this configuration to determine the time intervals that separate the battery charge cycles with active equalization phases.



Should incomplete charge cycles occur (for example, when charging using solar generators), this function is also useful in order to limit the frequency of equalization cycles.

End of equalization activated by the current {1168}

The equalization phase can be interrupted if the charge current of the battery goes under a certain threshold. This can be used to limit the operating period of a genset while keeping an acceptable battery charge.



During the equalization phase, the charge current decreases progressively in a natural way. If the bulk charge has been achieved with a current suitable for the battery, it is not necessary to respect a fixed period to complete the charge.

End of equalization current {1169}

Set the current under which the equalization phase will be considered as completed. When the charge current goes under this value the next phase starts.

Inverter configurations {1186}

Use this menu to adjust the different inverter configurations.

Standby level {1187}

The standby function allows energy to be saved if there is no consumer present at the inverter output. In this case, the inverter disconnects its output and periodically emits a load search pulse. If a consumer is detected, it goes back into operational mode while measuring the power supplied and returns to standby if the consumer is deactivated.

This configuration allows adjustment of the power output at which the inverter goes into standby mode.

Proceed as follows to adjust this configuration:

- Make sure that the inverter mode is active (no voltage present at the AC In input). The input voltage is 0 and the input relay is indicated as open in real time on the information screen.
- Increase the standby level value {1187} to the maximum
- Activate the smallest consumer that can be detected and ensure that all the others are deactivated.
- Wait for the inverter to pass to standby, and the consumer then engages intermittently around once a second.
- Progressively reduce the standby level value {1187} until the consumer runs permanently. If the consumer works for several seconds then stops, decrease the value of the standby level again.

An adjustment value between 0 and 100 is displayed. The value 100 represents the minimum sensitivity (biggest consumer detected).



If you would like to deactivate the standby function, it is sufficient to adjust the detection level to 0. In this case, the Xtender remains permanently activated if it is working in inverter mode.

Output voltage {1286}

The output voltage can be adjusted using this configuration.



In certain fields of application – for example, when the energy source is limited (solar or generator only) – it may be useful to reduce the output voltage of the inverter. This generally leads to a resulting reduction in the energetic consumption without significantly decreasing comfort. For example, a 100 W light bulb consumes around 100 W at 220 V and 15% more at 230 V.

Level of battery under-voltage at no load {1108}

Allows adjustment of the battery's low voltage level at which the inverter and smart boost functions are deactivated. This adjustment is applied in the case of a zero charge and is automatically adapted with regard to the power required from the batteries. This configuration is a factory setting for lead-acid batteries. Poor adjustment of this value leads to early ageing of the batteries due to deep discharges.

- A. Battery voltage
- B. Duration of undervoltage before disconnection {1190}
- C. Disconnection due to undervoltage
- D. Undervoltage level {1108}

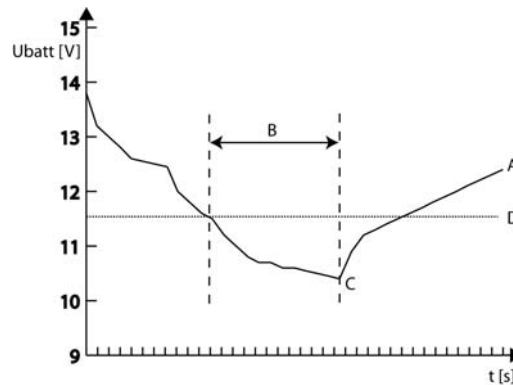

Adjust this configuration using the technical data for your battery.



The battery undervoltage level is automatically adapted to the instantaneous power of the consumers to compensate for internal losses in the battery and cables.

Acoustic alarm of the battery under-voltage {1196}

When the battery is discharged, the inverter stops in order to protect it from deep discharge. Before disconnecting, the inverter indicates this state via a message and activates the acoustic alarm. The alarm goes out when the inverter stops or after a defined duration {1469}

Duration of the acoustic alarm {1469}

The acoustic alarm stops automatically after a certain time and you can adjust the duration using this configuration.

Combi configurations Inverter-Charger {1197}

These configurations manage the combined functions between the charger and inverter. The conditions for passing from one function to another are adjusted in this category.

- A. Stoppage of charger operation {1309}
- B. Disconnection of transfer subject to delay {1199}
- C. Delay before opening of the transfer {1198}
- D. Immediate passage to the inverter threshold {1200}

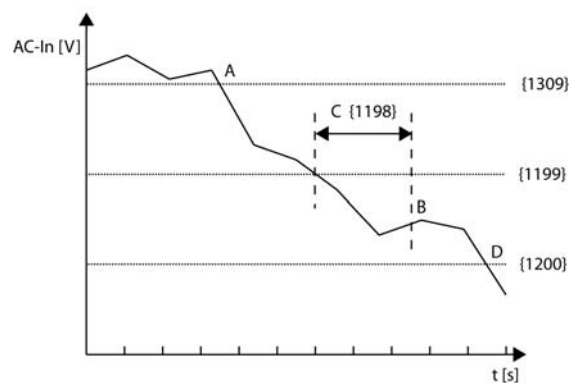

Minimum AC In voltage to authorise the charging {1309}

In the event of sources with limited power output (such as a generator, for example) the use of strong consumers at the output may lead to a drop in voltage. The adjustment of this configuration allows disconnection of the battery charging function and thus maintains the power available to other consumers without influencing the voltage of the source.

Transfer AC-In for delayed transfer opening {1199}

This configuration determines the voltage below which the transfer relay will open after a certain period of time. The Xtender will then run in inverter mode.

Delay before passing to inverter {1198}

When the input voltage is below the transfer voltage to the inverter, the transfer relay does not open immediately. With this configuration, the period during which the transfer remains drawn can be specified. After this duration, the transfer relay is opened and the inverter function is activated (if the function has not been blocked or deactivated).

	This delay is particularly useful on less stable grids or with generators with an output voltage that varies considerably during the activation of heavy loads.
---	---

Immediate transfer AC-In voltage {1200}

Use the adjustment of this configuration to adjust the critical voltage for the operation of equipment that must not experience interruptions. In the case of a fluctuating grid, if its voltage passes below the value of the configuration this immediately activates the inverter function, thereby ensuring supply to the consumers.

Activate immediate detection of grid outage (UPS) {1435}

This parameter allows to starting the inverter mode as quick as possible in case of fluctuations of the AC-In grid. This function is useful when it comes to very sensitive loads that require an uninterruptible power supply (UPS). If this function is active, being connected to a fluctuating source (weak grid or unstable generator) will lead to a frequent switching between inverter and charger modes by opening and closing of the transfer relay.

Authorisation for exceeding the power sharing current without interrupting the transfer {1436}

The parameter {1107} allows you to adapt the running of the Xtender to the maximum power of the source. In case this value is overrun, the transfer relay is not open and the circuit breaker on the source side may go on default. With this parameter you can force the transfer relay to open itself and the Xtender to work in inverter mode.

	Use this function if you have available a source that is smaller than the Xtender and if you don't use the function Smart-Boost. In this way, in case of overload of the source, all the power is supplied by the Xtender, up to its own limits.
---	--

Solsafe presence {1438}

This parameter allows the connection on the AC-Out side of an inverter for grid feeding. It also authorizes the Xtender to accept the energy coming from the output and to use it to charge the batteries.

Delay before closing of the transfer relay {1528}

This parameter enables to delay the closing of the transfer relay even if the AC-In voltage is present.

	This function can be useful while working with gensets having a pre-warming delay.
---	--

Configurations for auxiliary contacts 1 and 2 {1201} {1310}

The Xtender inverter/charger is equipped with two auxiliary relays each with one free of potential contact (reverser). These two relays allow multiple functions to be carried out by using adequate cabling as well as simple programming.

The programming of each contact is carried out independently except when conditions require the use of two relays. In this case, the programmed events for activating the second relay are automatically deactivated.

The extended functions of the auxiliary contacts are described at the end of the chapter on simple functions.

The auxiliary contacts are activated immediately in response to the programmed signals. When the activation conditions are no longer fulfilled, they are deactivated with a delay of 2 seconds to avoid overswitching.

The auxiliary contacts respond to various signal types presented graphically below. The following types of basic events may activate the contacts:

- Simple event
- Scheduled event
- Level

In the following description, each parameter has two reference numbers. The reference on the left relates to auxiliary contact 1 and the reference on the right to auxiliary contact 2 ((reference of the auxiliary contact 1) {reference of the auxiliary contact2}).

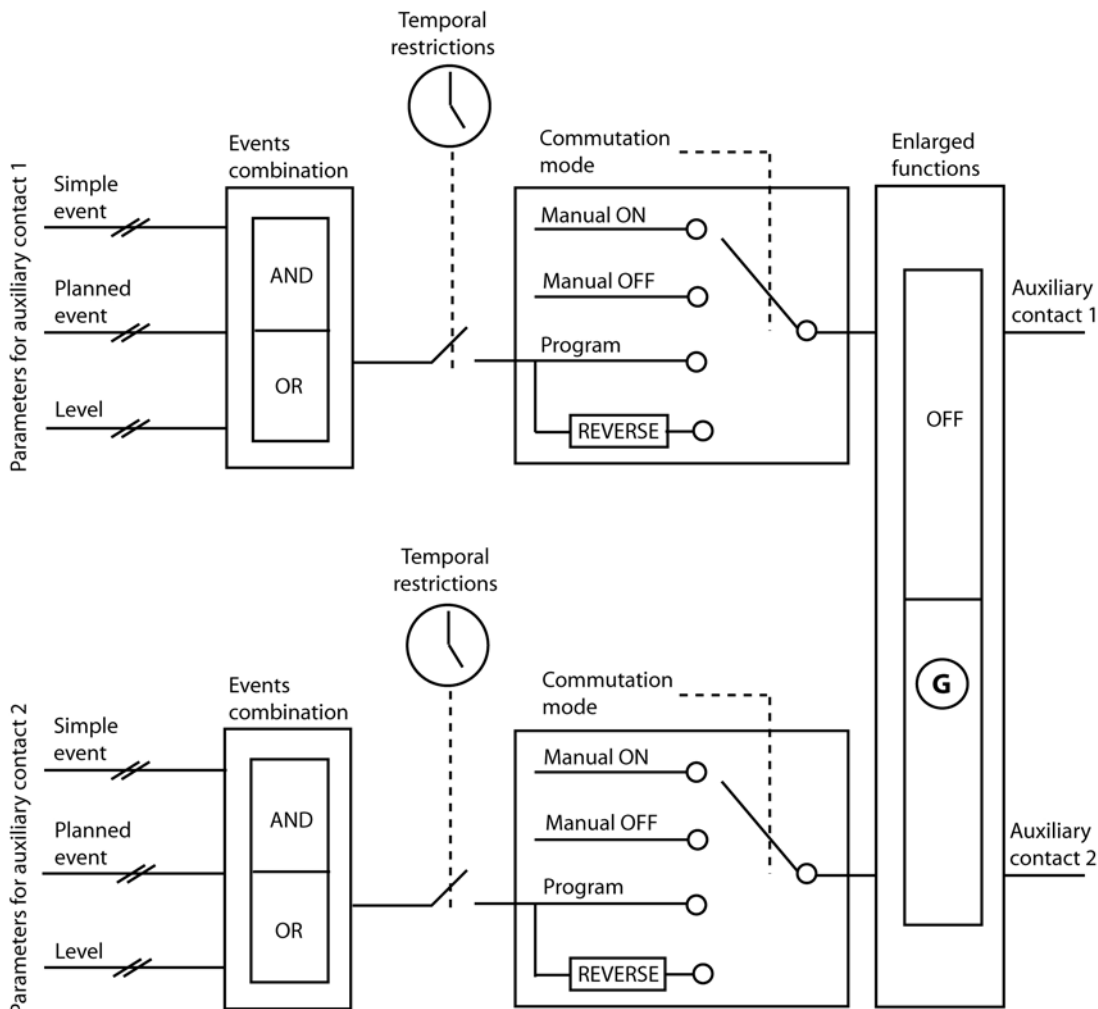

Simple functions

Switching mode {1202} {1311}

The auxiliary contacts may be controlled in 4 different ways:

Manual ON: In this mode, the contact is permanently drawn whatever the external conditions or programming

Manual OFF: In this mode, the contact is permanently released whatever the external conditions or programming

Automatic: In this mode, the auxiliary contact is activated according to the conditions and restrictions of its programming.

Reversed automatic: In this mode, the conditions and restrictions define the release of the contact.

Combination of events mode {1497} {1498}

This configuration defines how the various events intended to activate the auxiliary contact are combined.

Either a single event suffices to activate the contact (OR function) or it must have all the active events in order for the contact to be activated (AND function).

Limit the time of activation {1512} {1513}

Maximum duration of activation {1514} {1515}

When the conditions are met, either one or two relays are activated permanently. If you wish that the activation duration is limited in time, even if the conditions are met, you can activate this function. Once the relay is activated, a countdown runs according to the duration you have selected. Once this countdown is completed the relay is released, even if the conditions are still there. The relay can not be anymore activated as long as the activation conditions have not disappeared.

Temporal restrictions {1203} {1312}

These configurations allow the time frame to be defined in which the contact should under no circumstances be activated. Three distinct schedules are accessible in the form of restriction programs (programs 1 to 3). For each program, it is possible to select the day of the week where the restriction is activated. If the day is selected it appears on the screen and if it is not selected it is represented on the screen by two horizontal lines.

Once the days are selected, it is necessary to adjust the time frame where the restriction is active using the "starting time" and "finishing time" configurations. If the finishing time is programmed before the starting time, the restriction time frame is not taken into account. Below are the configurations with their references:

- Program 1 {1204} {1313}
 - Days of the week {1205} {1314}
 - Starting time {1206} {1315}
 - Finishing time {1207} {1316}
- Program 2 {1208} {1317}
 - Days of the week {1209} {1318}
 - Starting time {1210} {1319}
 - Finishing time {1211} {1320}
- Program 3 {1212} {1321}
 - Days of the week {1213} {1322}
 - Starting time {1214} {1323}
 - Finishing time {1215} {1324}



If your installer has made additional adjustments, it is possible that the restrictions could be active even if they do not appear in one of the three programs available to you.

Contacts activated by an event {1455} {1456}

The auxiliary contacts may be activated by the states or events occurring in the installation. Each event may be combined with another to establish complex functions.

Xtender OFF {1225} {1333}

The contact is activated if the Xtender inverter/charger is switched off, either following a fault or manually.

Battery undervoltage alarm {1226} {1334}

If the undervoltage threshold is reached, this activates the contact. In contrast to the acoustic alarm that is deactivated after a set time, this signal remains active as long as the battery voltage is below the threshold. If the undervoltage fault cuts in, this condition remains active as does the contact.

Battery overvoltage {1227} {1335}

Activates the contact in the event of battery overvoltage.

Inverter or smart boost overload {1228} {1336}

Activates the contact in the event of an error due to excessive power in the inverter or the Smart Boost function. In the event that the inverter disconnects due to excess power and it is attempting to restart, the contact is not activated until the end of the attempts.

Overtemperature {1229} {1337}

Activates the contact in the event of overtemperature in the electronics or the transformer.

No Overtemperature alarm {1520} {1521}

Activates the auxiliary contact if the charger function is active. When the function Smart-Boost is running, the condition is not met to activate the contact.

Active charger {1231} {1339}

Activates the auxiliary contact if the charger function is active. When the smart boost function is operating, the condition for activating the contact is not fulfilled.

Active inverter {1232} {1340}

Activates the auxiliary contact if the inverter function is active.

Smart boost active {1233} {1341}

Activates the auxiliary contact if the smart boost function is active. For more information on the smart boost function, refer to the manual for the Xtender inverter/charger.

AC In present with fault {1234} {1342}

Activates the auxiliary contact if there is voltage present at the AC In input but this voltage does not fulfil the conditions for activating the transfer relay.

AC In present {1235} {1343}

Activates the auxiliary contact if a voltage is present at the AC In input. This condition is independent of the state of the transfer relay.

Transfer relay drawn {1236} {1344}

Activates the auxiliary contact if the transfer relay is drawn.

AC Out present {1237} {1345}

Activates the auxiliary contact if a voltage is present at the output of the Xtender inverter/charger.

Battery charging in bulk charge phase {1238} {1346}

Activate the auxiliary contact if the battery is in bulk charge phase.

Battery charging in absorption phase {1239} {1347}

Activates the auxiliary contact if the battery is in absorption phase. If the periodic extended absorption function is activated, the contact is also activated in this phase.

Battery charging in equalization phase {1240} {1348}

Activates the auxiliary contact if the battery is in equalization phase.

Battery charging in floating phase {1242} {1350}

Activates the auxiliary contact if the battery is in maintenance phase. If the extended reduced floating function is activated, the contact is also activated in this phase.

Contacts activated by the battery voltage {1245} {1353}

These configurations allow activation of the auxiliary contacts if the battery voltage passes below a selected voltage during a period that is configurable as well. Three voltages linked to three durations are configurable to activate the auxiliary contact.

Studer Innotec

The auxiliary contact will only be activated after the battery exceeds again a certain voltage value and also after a duration, both independently of the activation parameters. This voltage and this duration are programmable too.

- Dynamic compensation of the thresholds {1288} {1354}
- Voltage 1 active {1246} {1355}
- Voltage 1 {1247} {1356}
- Duration 1 {1248} {1357}
- Voltage 2 active {1249} {1358}
- Voltage 2 {1250} {1359}
- Duration 2 {1251} {1360}
- Voltage 3 active {1252} {1361}
- Voltage 3 {1253} {1362}
- Duration 3 {1254} {1363}
- Voltage for deactivation of the auxiliary contact {1255} {1364}
- Duration over battery voltage for deactivation {1256} {1365}
- Deactivate if the battery is in floating mode {1516} {1517}

Dynamic compensation of the thresholds {1288} {1354}

If the contacts are activated according to the battery voltage, you can use the voltage compensated dynamically for each threshold.

If this function is not activated, then the average battery voltage will be used.

If this function is activated, the real battery voltage is compensated according to power used.

Deactivate if the battery is in floating mode {1516} {1517}

If you activate one of the auxiliary contacts according to the battery voltage, you can force the deactivation if the battery is in floating mode. In this way, even if the deactivation voltage is not reached or if the duration of the voltage deactivation is not completed, the auxiliary contact will be released.

Contacts activated by inverter power or smart boost {1257} {1366}

If the power output of the inverter exceeds a certain level, the contact may be activated. The exceedance is linked to a duration. Three power levels linked to three durations are configurable to activate the auxiliary contact.

The auxiliary contact will only be activated after the output power passes below a value and during a duration, both independently of the activation configurations.

If the smart boost function is active, these configurations are also taken into account with the power of the boost.

- Power 1 active {1258} {1367}
- Power 1 {1259} {1368}
- Duration 1 {1260} {1369}
- Power 2 active {1261} {1370}
- Power 2 {1262} {1371}
- Duration 2 {1263} {1372}
- Power 3 active {1264} {1373}
- Power 3 {1265} {1374}
- Duration 3 {1266} {1375}
- Power for deactivation of the auxiliary contact {1267} {1376}
- Duration below power for deactivation {1268} {1377}

Contacts activated with set schedules {1269} {1378}

The auxiliary contact can also be activated like a programmable clock. Three different weekly programs are available.

For each program, the time frame may be applied to one or several days of the week.

If the finishing time is programmed before the starting time, the time frame is not taken into account.

- Program 1 {1270} {1379}
 - Days of the week {1271} {1380}
 - Time of start of activation {1272} {1381}

- Time of end of activation {1273} {1382}
- Program 2 {1274} {1383}
 - Days of the week {1275} {1384}
 - Time of start of activation {1276} {1385}
 - Time of end of activation {1277} {1386}
- Program 3 {1278} {1387}
 - Days of the week {1279} {1388}
 - Time of start of activation {1280} {1389}
 - Time of end of activation {1281} {1390}

Extended functions {1489}

Generator startup {1490}

The two contacts may be combined in order to automatically start up a generator equipped with an electric starter. In this case the two contacts are dedicated to this function.

Auxiliary contact 1 serves as an operational contact and auxiliary contact 2 as a startup contact.

The startup condition of the generator must be programmed with the configurations of auxiliary contact 1. The startup is carried out by first activating the operational contact and then activating the startup contact. The latter engages several times, if necessary, to start up the motor. If a voltage appears at the terminals of AC In, the startup contact is released.

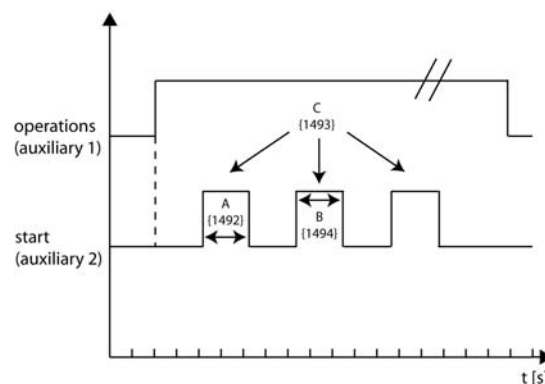

- A. Duration of starter impulse {1492}
- B. Duration between attempts {1494}
- C. Number of attempts {1493}

Generator startup {1491}

Activates the combination of the two auxiliary contacts for the generator start and the management of the start impulses.

Duration of starter impulse {1492}

With this configuration you can adjust the time at which the startup contact is activated.

Number of startup attempts {1493}

The startup contact is activated a limited number of times in order to protect the starter if the generator has a fault. Once the maximum number of startups has been reached, the operational contact is also deactivated. For a new attempt to be made the condition that generated the startup must disappear and reappear.

Duration between the starter attempts {1494}

This configuration determines the duration between the startup attempts. It also determines the duration between the activation of the operational contact and the first attempt at restarting.

Multi Xtender {1282}

This section allows setting the operating possibilities of systems with several Xtenders. Either parallel or 3-phase.

3-phase integral mode {1283}

If you activate this parameter, the system will work in order to have either a 3-phase output, or no output voltage. For instance in case of one phase overload, if the integral mode is activated, the cut of this phase will lead to the cut of all phases.

INFORMATION ON THE SYSTEM

The system information allows you to check the versions of the various elements of your installation.

REMOTE CONTROLS

You will receive information on the hardware and software versions for each remote control. Furthermore, you have access to its unique ID number. This unique number is marked FID followed by its ID.

XTENDER

For each Xtender connected at the remote control, you can consult the following information: the hardware version of the motherboard itself as well as the powerboard, the software version of the Xtender program and the unique ID of the Xtender. This unique number is also marked FID and followed by its ID.

UPDATES

The RCC remote control program as well as the code in the inverters/chargers of the Xtender series can be updated in order to integrate new features.

For the RCC remote control it is also possible to implement new display languages (up to a maximum of 4 on each RCC remote control). You may obtain information about the availability of updates or additional languages from your installer or consult the website: www.studer-innotec.com.

UPDATING PROCESS



Before introducing the SD card to carry out the updating, do switch off all Xtenders (off).

To carry out an update, enter the SD card containing the correct files in the RCC remote control slot intended for this.

The system checks the compatibility of the hardware with the software present on the SD card and if it proves to be compatible the update is carried out automatically.

The SD card must not be removed before the end of the updating process. Yet if the updating process is interrupted, the SD card has to be inserted again and the process will carry on.

The steps of the updating process are the following:

- Updating the code of the remote control.
- Updating of the files of the remote control.
- Updating of the files of the inverters.
- Updating of the code of the inverters.

The updating process takes 3 to 15 minutes, depending on the number of inverters connected to the remote control.

Once the update has been carried out, the remote control displays the basic screen and you have immediate access to the new functions.

When there is a change of language, the system restarts automatically with the new language as the current language.

If the installation consists of several remote controls, each of them has to be updated separately.



Beware: the updating will stop the running of all Xtenders connected to the remote control.

COMPATIBILITY

Studer Innotec guarantees the compatibility of the software updates with the hardware for one year, starting from the date of purchase. The updates are no longer guaranteed beyond this date and a hardware upgrade may be required. Please contact your reseller for any additional information on compatibility.

APPLICATION EXAMPLES

The examples below illustrate some implementation options for current installations. Useful configurations for these situations are also given. These are common and non-obligatory configurations.

For more details on each configuration shown, please refer to the complete description given above in this manual.

GÉNÉRAL USE : INVERTER, CHARGER WITH GRID

Description:

In this configuration, the Xtender is connected to a grid with high power output. The basic functions are configured for this type of application. The loads are supplied by the grid via the transfer relay and this helps to charge the battery. In the event of a disconnection from the grid, the transfer is stopped and the inverter is activated automatically.

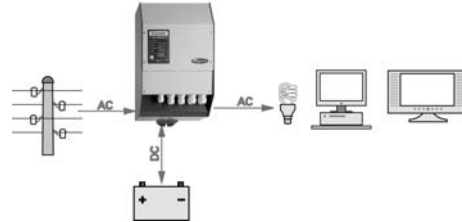

Associated current configurations:

- Battery charge current {1138} Adapt this configuration to the technical data for the batteries for the best charging capacity.
- Adjustment of the standby level {1187} Adjust this configuration if the minimum load has not been detected or, conversely, if the inverter remains engaged when all the loads have been deactivated.

Additional configurations:

- Battery curve {1140} {1156} {1157} Adapt these configurations in order to adjust the voltage levels and the durations of charge to your battery manufacturer's data.

USE OF A LIMITED POWER SOURCE

Description:

For example, a source such as a generator, a camping or dock connection. In this case the power available is limited. In the case of high power consumers the source is insufficient and needs an assistance by means of the energy stored in the batteries.

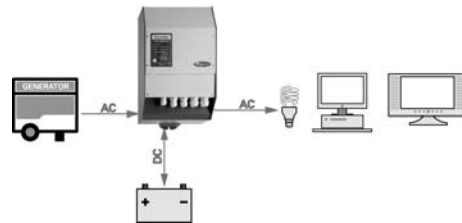

Associated current configurations:

- Maximum current of the AC source {1107} By adjusting this configuration to the maximum current that the source can supply, the power available is ideally shared between the battery charging and the consumers. For example, if a load is deactivated, the battery charger current is automatically increased.
- Locking: Smart boost active {1126} In the event that the maximum source current is exceeded, the inverter supplies the energy required to keep the source current at the set maximum level. Thus, the inopportune stopping of the generator is avoided, the circuit breaker of the dock or camping connection is not activated and the supply of the loads is assured.
- Option of exceeding the power sharing value without opening the transfer relay {1436}. Allows retention of the drawn transfer in the event of consumption of peak currents such as compressor startups.

USE TO INCREASE THE POWER ON AN EXISTING INSTALLATION

Description:

The availability of an inverter or a inverter/charger allows its power to be extended with an Xtender connected in cascade. The maximum power of the first inverter is limited by the maximum current from the transfer relay of the Xtender.

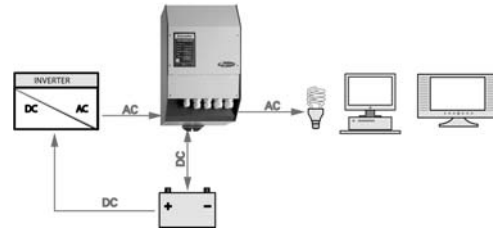

Associated current configurations:

- Maximum current of the AC source {1107} Adjust this configuration in relation to the maximum current that can supply the old inverter.
- Locking: Smart boost inactive {1126} Suppress the locking of this function: This way, when the first inverter has reached it maximum power, the power consumed that will be supplied by the Xtender could be increased.
- Locking: Inactive charger {1125} This lock, without which the battery energy would be taken by the first inverter, is returned by the Xtender charger. This would only have the effect of discharging the battery with losses caused in the two inverters or inverter/chargers.

LOAD SHEDDING OF THE SECOND PRIORITY LOADS

Description:

Consumers with different supply priorities allow automatic disconnection of the supply to consumers of lower priority if the battery becomes weak. The supply of the priority loads is thus assured, such as lighting or computers, for example. In this case, the low-priority loads must be cabled via one of the auxiliary relays. The reference for the example below correspond to the auxiliary contact no 1.

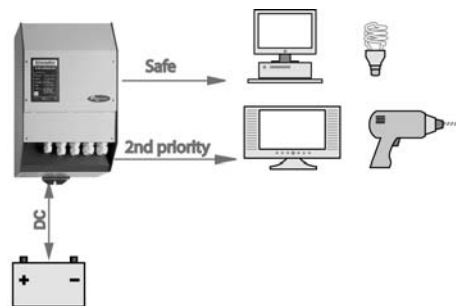

Associated current configurations:

- Communication mode {1202}
- Relay activated by the battery voltage {1245}
- Voltage 1 active {1246}
- Voltage 1 {1247}
- Duration 1 active {1248}
- Voltage for deactivation of the auxiliary relay {1255}
- Duration for deactivation {1256}

ANNEXES

ANNEXE 1 : LIST OF CONFIGURATION INTERDEPENDENCIES

N°	Configuration	N°	Minimum limit by	N°	Maximum limit by
1108	Undervoltage of the empty battery	1109	Undervoltage of the charged battery	1110	Reactivation voltage after battery undervoltage
1109	Undervoltage of the charged battery			1108	Undervoltage of the empty battery
1110	Reactivation voltage after battery undervoltage	1108	Undervoltage of the empty battery		
1113	Activation temperature for buzzer	1114	Deactivation temperature for buzzer		
1114	Deactivation temperature for buzzer			1113	Activation temperature for buzzer
1115	Maximum operating temperature	1116 1308 1292	Restart temperature Temperature at which the charge current begins to reduce Temperature for the start of the output correction (Uout)		
1116	Restart temperature			1115	Maximum operating temperature
1117	Activation temperature for ventilator speed 1	1118	Deactivation temperature for ventilator speed 1		
1118	Deactivation temperature for ventilator speed 1			1117	Activation temperature for ventilator speed 1
1119	Activation temperature for ventilator speed 2	1120	Deactivation temperature for ventilator speed 2		
1120	Deactivation temperature for ventilator speed 2			1119	Activation temperature for ventilator speed 2
1121	Maximum operating voltage	1122	Reactivation voltage after battery overvoltage		
1122	Reactivation voltage after battery overvoltage			1121	Maximum operating voltage

1308	Temperature at which the charge current begins to reduce			1115	Maximum operating temperature
1140	Battery maintenance voltage (floating)			1156	Battery absorption voltage
1152	Startup voltage of the timer before alarm			1156	Battery absorption voltage
1156	Battery absorption voltage	1140	Battery maintenance voltage (floating)		
1164	Battery equalization voltage	1156	Battery absorption voltage		
1172	Reduced maintenance voltage			1140	"Battery maintenance voltage (floating)"
1174	Periodic absorption voltage	1172	Reduced maintenance voltage		
1292	Temperature for the start of the output correction (Uout)			1115	Maximum operating temperature
1195	Adaptable maximum low voltage	1108	Undervoltage of the empty battery		
1199	Transfer voltage to the inverter	1200	Immediate open critical threshold for the transfer (UPS)		
1200	Immediate open critical threshold for the transfer (UPS)			1199	Transfer voltage to the inverter
1255	Deactivation voltage	1247 1250 1253	Voltage 1 Voltage 2 Voltage 3		
1267	Deactivation power			1259 1262 1265	Power 1 Power 2 Power 3
1364	Deactivation voltage	1356 1359 1362	Voltage 1 Voltage 2 Voltage 3		
1376	Deactivation power			1368 1371 1374	Power 1 Power 2 Power 3

NOTES



Free Manuals Download Website

<http://myh66.com>

<http://usermanuals.us>

<http://www.somanuals.com>

<http://www.4manuals.cc>

<http://www.manual-lib.com>

<http://www.404manual.com>

<http://www.luxmanual.com>

<http://aubethermostatmanual.com>

Golf course search by state

<http://golfingnear.com>

Email search by domain

<http://emailbydomain.com>

Auto manuals search

<http://auto.somanuals.com>

TV manuals search

<http://tv.somanuals.com>