

BRITA® Water Filter & Chiller II

Chilled water filter

Instruction Booklet
WF6100

Please read these instructions carefully
and retain for future reference.



Contents

Sunbeam's Safety Precautions	1
Features of your Water Filter & Chiller	2
Using your Water Filter & Chiller	4
Care and Cleaning	8
Help Line	8

Important instructions – retain for future use.

تأكد من تفهم احتياطات السلامة المذكورة اعلاه

請務必理解上述的安全預防措施。

Assurez-vous que les précautions ci-dessus relatives à la sécurité sont bien comprises

Versichern Sie sich, dass die obenstehenden Sicherheitsmaßnahmen Verstanden werden

Βεβαιώνετε πως οι παραπάνω προφυλάξεις ασφαλείας γίνονται κατανοητές

Pastikan bahwa tindakan-tindakan keselamatan seperti di atas dimengerti anda

Accertatevi che le suddette norme di sicurezza siano comprese a dovere

上記の注意事項をよくお読みになり、安全を御確認ください

Уверете се дека погоре споменатите мерки на претпазливост се добро разбрани

Asegúrese de que las precauciones de seguridad precedentes sean bien comprendidas

کاری بکنید کہ احتیاط‌های بالا حتماً درک بشوند

ต้องแน่ใจว่า ข้อควรระวังเรื่องความปลอดภัยข้างต้น เป็นที่เข้าใจกันดี

Yukarda belirtilen güvenlik önlemlerinin anlaşılığundan emin olunuz

Xin kiểm chắc rằng những biện pháp làm an toàn kể trên được hiểu rõ

Sunbeam's Safety Precautions

SAFETY PRECAUTIONS FOR YOUR WATER FILTER & CHILLER.

- This water filter must only be used with municipally treated water. Do not attempt to filter untreated, raw water or water of unknown quality.
- Filter replacement is essential for the product to perform as represented. The filter must be replaced every eight weeks.
- To protect against electric shock do not place the cord, plug or appliance in water or any other liquid.

- Always place the appliance on a flat, even surface.
- Always unplug the appliance before changing the filter.
- This appliance has been designed to be used continuously.
- Do not operate without a filter in place.
- Do not place this unit in an area that receives direct sunlight. Placing the unit in direct sunlight can affect unit performance as well as promote the growth of algae.

Sunbeam is very safety conscious when designing and manufacturing consumer products, but it is essential that the product user also exercise care when using an electrical appliance. Listed below are precautions which are essential for the safe use of an electrical appliance:

- Read carefully and save all the instructions provided with an appliance.
- Always turn the power off at the power outlet before you insert or remove a plug. Remove by grasping the plug - do not pull on the cord.
- Turn the power off and remove the plug when the appliance is not in use and before cleaning.
- Do not use your appliance with an extension cord unless this cord has been checked and tested by a qualified technician or service person.
- Always use your appliance from a power outlet of the voltage (A.C. only) marked on the appliance.
- This appliance is not intended for use by persons (including children) with reduced physical, sensory or mental capabilities, or lack of experience and knowledge, unless they have been given supervision or instruction concerning use of the appliance by a person responsible for their safety.
- Children should be supervised to ensure that they do not play with the appliance.
- The temperature of accessible surfaces may be high when the appliance is operating.
- Never leave an appliance unattended while in use.

- Do not use an appliance for any purpose other than its intended use.
- Do not place an appliance on or near a hot gas flame, electric element or on a heated oven.
- Do not place on top of any other appliance.
- Do not let the power cord of an appliance hang over the edge of a table or bench top or touch any hot surface.
- Do not operate any electrical appliance with a damaged cord or after the appliance has been damaged in any manner. If damage is suspected, return the appliance to the nearest Sunbeam Appointed Service Centre for examination, repair or adjustment.
- For additional protection, Sunbeam recommend the use of a residual current device (RCD) with a tripping current not exceeding 30mA in the electrical circuit supplying power to your appliances.
- Do not immerse the appliance in water or any other liquid unless recommended.
- Appliances are not intended to be operated by means of an external timer or separate remote control system.
- This appliance is intended to be used in household and similar applications such as: staff kitchen areas in shops, offices and other working environments; farm houses; by clients in hotels, motels and other residential type environments; bed and breakfast type environments.

If you have any concerns regarding the performance and use of your appliance, please visit www.sunbeam.com.au or contact the Sunbeam Consumer Service Line on 1300 881 861. Ensure the above safety precautions are understood.

Features of your Water Filter & Chiller

Memo display

Provides an indication of when the BRITA® MAXTRA Cartridge needs to be replaced.

2 litre filtering tank

Holds two litres of water before it passes through the BRITA® MAXTRA cartridge.

Power on and chilled indicator light

A white light will display when the unit is turned on and will switch to blue to let you know when water is chilled.

Water dispensing lever

Simply push the lever in to dispense fresh tasting filtered and chilled water.

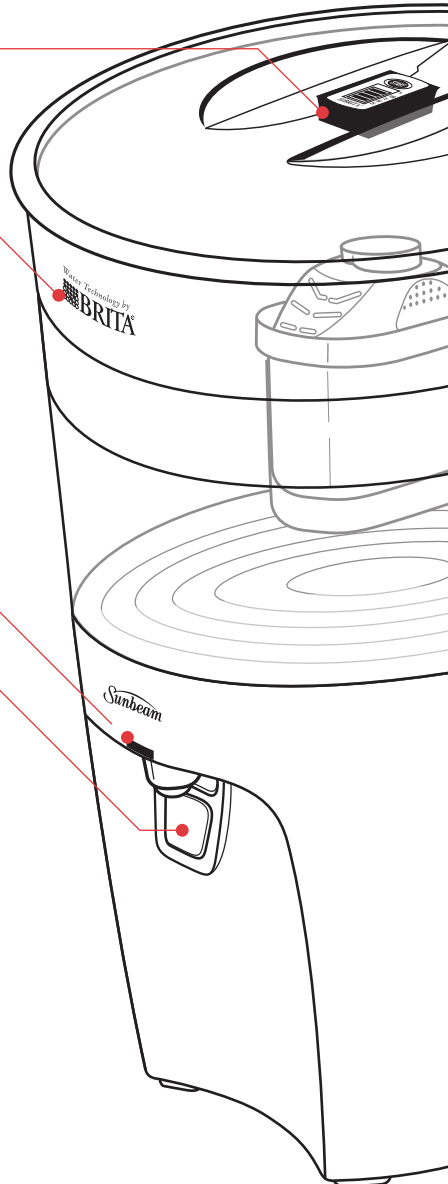

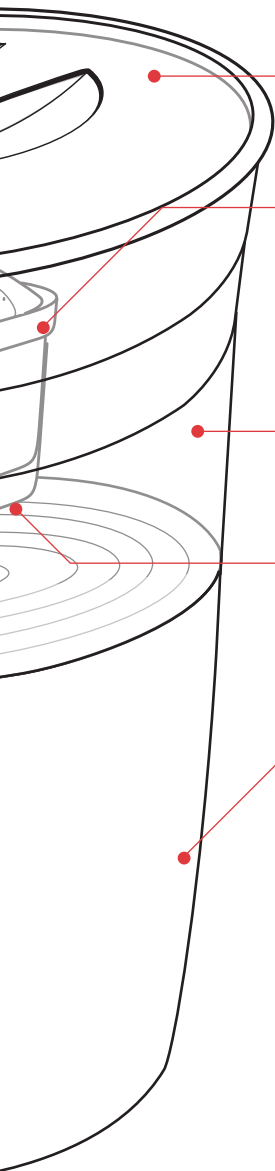

Lid

Protects your water from dust and other impurities.

BRITA® Maxtra cartridge

Offers advanced filtration due to MAXTRA Technology which reduces chlorine and limescale as well as metals such as lead and copper to give you great tasting water every time.

4 litre filtered water tank

Holds 4 litres of water which travels to the 1.2 litre chilling reservoir.

Filter funnel

A key element of the filtration system allowing filtered water to pass into the water tank before it reaches the chilling reservoir.

1.2 litre chilling reservoir

Holds 1.2 litres of refreshing chilled water at a time.

BRITA® MAXTRA filter cartridge

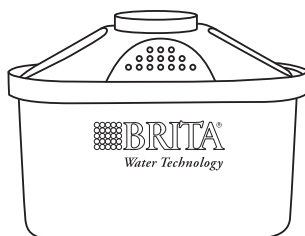

Using your Water Filter & Chiller

Before using your Water Filter & Chiller

- Carefully unpack the appliance and check that all the components are included. Please refer to pages 2-3.
- Remove the filter cartridge and put to one side.
Do not re-insert until (a) flushing process and (b) preparation of filter cartridge procedures, as explained below, have been completed.
- Wipe out the filtered water tank with a damp cloth which has been soaked in water.
- Position the appliance on a dry, level and secure bench top. Allow for good airflow around the appliance so do not place directly against a wall.
- Do not position the unit in an area that receives direct sunlight. Placing the unit in direct sunlight may affect unit performance as well as promote the growth of algae.

Flushing Process

- It is important that you flush and rinse out the dispensing system before using the appliance for the first time.
- Fill the water tank to the brim with hot tap water.
- Place a large container or jug under the spout.
- Press the dispenser lever until all the water is dispensed and the water tank is empty.
- Repeat this flushing process twice with cold tap water and discard.
- Please note that when flushing for the first time, while pressing the dispensing lever, no water will be dispensed until the tank is almost empty as it will be filling the chilling tank.
- Do not fill above the maximum level indicated.
- Please note that you should carry out these steps without the Maxtra cartridge in place.
- Plug the appliance into an appropriate electrical outlet and switch on.
- A white power on light will be illuminated to show that the appliance is switched on and working.

Using your Water Filter & Chiller (continued)

Preparing the BRITA® MAXTRA filter cartridge for use

- Remove the cartridge from its wrapping (it is normal for the cartridge to appear moist).
- Immerse the cartridge in cold water and agitate gently to remove any air bubbles. (See figure 1).

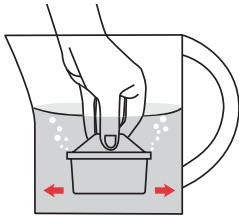

Figure 1

- Insert the cartridge into the 2 litre filtering tank and push it firmly into place until it 'clicks'.
- Place the filtering tank into the sink. Fill the filtering tank from the tap with cold water, and allow the water to pass through the filter into the sink until empty. This first filling is used to activate the filter cartridge.
- Insert the filtering tank into the water tank. Now refill with cold tap water, and the system is ready for use.
- To exchange the cartridge, simply use the ring pull handle on the top of the cartridge to remove it from the funnel. (See figure 2).



Figure 2

Note: Repeat the cartridge preparation process each time you insert a new cartridge.

- Once the water has been filtered, you can refill this section.
- This will then filter through as water is dispensed.
- After approximately 4 hours, the power light will change from white to blue to indicate that the water has been chilled.
- The light may flicker from blue to white as water is dispensed and if the ambient temperature increases. The fan may be activated in these conditions and will remain so until the required temperature has been reached.

Using your Water Filter & Chiller (continued)

Filtering time

Please note that on average it will take 5½ minutes to filter 1 litre of water through the BRITA® MAXTRA cartridge.

Using the Memo function

It is important to change your filter cartridge regularly to enjoy the benefits of filtered water.

The BRITA® Memo system automatically reminds you when your filter cartridge needs to be changed. It is automatically calibrated according to average use of one litre of water per day and will remind you to change your filter every 8 weeks. If you are a heavier user than one litre per day you will need to change your filter more often according to your usage rate. A filter will effectively filter 150 litres of water before needing replacement.

Once you have fitted and prepared your filter cartridge as outlined on page 5, start the Memo system as follows:

- Press and hold the Start button until 4 bars appear on the display and flash twice. The Memo is now set. The flashing dot in the corner of the display indicates that the Memo is working. (See figure 3).

Note: Repeat the cartridge preparation process each time you insert a new cartridge.

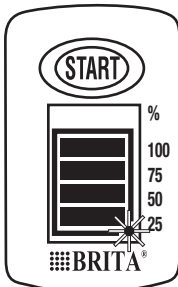

Figure 3

- At the end of every two weeks, one bar will disappear to indicate the remaining cartridge life. When only one bar is showing, ensure that you have a replacement BRITA® MAXTRA water filter cartridge available. (See figure 4).

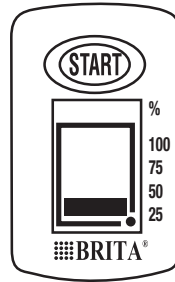

Figure 4

- After 8 weeks, all four bars will disappear and a flashing arrow will appear to indicate that the cartridge should be replaced. (See figure 5).

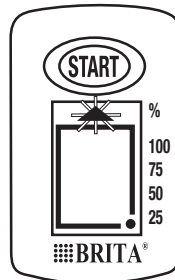

Figure 5

Wash and dry the filter funnel, insert a new cartridge (see 'Preparing the filter cartridge for use') and restart the BRITA® Memo as described above.

Note: The Memo system is only intended to be used with BRITA® filter cartridges.

Using your Water Filter & Chiller (continued)

- The cartridge may be disposed of in household waste or contact the BRITA® consumer service for advice on recycling schemes. Refer to page 8 for contact details.
- Always ensure that you have spare BRITA® MAXTRA cartridges available.

For more information on where to purchase BRITA replacement filters please visit www.brita.com.au for Australia or www.brita.co.nz for New Zealand.

You can also reach BRITA by email: solutions@brita.com.au or call BRITA Customer Service in Australia on 1300 557 762 or in New Zealand on 0800 4 BRITA/0800 437 82.

Care and Cleaning

- Do not use harsh detergents or abrasive cleaners.
- Do not place any part of this appliance in a dishwasher.
- Wipe the base with a clean cloth or paper towel.
- Wash the filtering tank in warm, soapy water using a mild detergent.
- Wipe the inside of the filtered water tank with a damp cloth which has been soaked in water.
- Do not immerse the base in water or any other liquid.
- If the unit is to be moved or stored for a prolonged period of time without being used, we recommend that you drain the internal tank of any water. Flush the unit as described on page 4 before using again.

Emptying the internal tank

- Switch off the appliance and unplug from the mains.
- Remove the lid and the filtering tank and any water in the filtered water tank.
- Turn the appliance upside down to reveal a drain plug located in the centre of the base. (See figure 6).

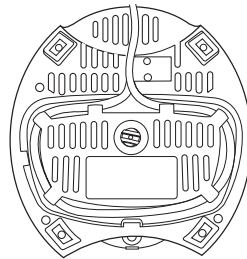

Figure 6

- Using a coin or a suitable screw driver, turn the plug anti clockwise until it is fully loosened. Please note that it cannot be completely removed.
- Drain the tank.
- Insert the plug after draining and using a coin or suitable screwdriver, turn it clockwise until it stops.
- Do not over tighten as this may damage the plug.

Help Line

If you have any additional questions about using the Water Filter & Chiller, please call the Sunbeam help line in Australia on 1300 881 861. In New Zealand, please call 0800 786 232. For BRITA® filter cartridge and Memo enquiries, contact BRITA® Customer Care. In Australia please call 1300 557 762. In New Zealand, please call 0800 427 482.

Notes

Notes

Notes

Notes

12 Month Warranty

This Sunbeam product is covered by a 12 month replacement or repair warranty, which is in addition to your rights under the Australian Consumer Law (if your product was purchased in Australia) or New Zealand Consumer Guarantees Act (if your product was purchased in New Zealand).

Should you experience any difficulties with your product during the warranty period, please contact our customer service line for advice on 1300 881 861 in Australia, or 0800 786 232 in New Zealand.

Alternatively, you can send a written claim to Sunbeam to:

Australia

Units 5 & 6, 13 Lord Street
Botany NSW 2019 Australia

New Zealand

26 Vestey Drive
Mt Wellington, Auckland New Zealand

Upon receipt of your claim, Sunbeam will seek to resolve your difficulties or, if the product is defective, advise you on how to obtain a replacement or refund.

To assist us in managing warranty claims, we recommend you register your product as soon as practicable after purchase by creating a MySunbeam account on our website and send a copy of your original receipt to Sunbeam.

In order to make a claim under our warranty, you must have the original proof of purchase documentation for the product and present it when requested.

Should your product develop any defect within 12 months of purchase because of faulty materials or workmanship, we will replace or repair it, at our discretion, free of charge. A product presented for repair may be replaced by a refurbished product of the same type rather than being repaired. Refurbished parts may be used to repair the product.

Our replacement or repair warranty only applies where a defect arises as a result of faulty material or workmanship during the warranty period. Your warranty does not cover misuse or negligent handling (including damage caused by failing to use the product in accordance with this instruction booklet), accidental damage, or normal wear and tear.

Your warranty does not:

- cover freight or any other costs incurred in making a claim, consumable items, accessories that by their nature and limited lifespan require periodic renewal (such as filters and seals) or any consequential loss or damage; or
- cover damage caused by:
 - power surges, power dips, voltage supply problems, or use of the product on incorrect voltage;
 - servicing or modification of the product other than by Sunbeam or an authorised Sunbeam service centre;
 - use of the product with other accessories, attachments, product supplies, parts or devices that do not conform to Sunbeam specifications; or
 - exposure of the product to abnormally corrosive conditions; or
- extend beyond 3 months if the product is used in commercial, industrial, educational or rental applications.

The benefits given to you by our warranty are in addition to other rights and remedies under law in relation to the product.

In Australia our goods come with guarantees that cannot be excluded under the Australian Consumer Law. You are entitled to a replacement or refund for a major failure and for compensation for any other foreseeable loss or damage. You are also entitled to have the goods repaired or replaced if the goods fail to be of acceptable quality and the failure does not amount to a major failure.

Our goods also come with guarantees that cannot be excluded under the New Zealand Consumer Guarantees Act.

If your warranty claim is not accepted, we will inform you and if requested to do so by you, repair the product provided you pay the usual charges for such repair. You will also be responsible for all freight and other costs.

Should your product require repair or service after the warranty period, contact your nearest Sunbeam service centre. For a complete list of Sunbeam's service centres, visit our website or call our customer service line for advice on 1300 881 861 in Australia, or 0800 786 232 in New Zealand.

Need help with your appliance?

Contact our customer service team or visit our website for information and tips on getting the most from your appliance.

In Australia

Visit www.sunbeam.com.au

Or call 1300 881 861

In New Zealand

Visit www.sunbeam.co.nz

Or call 0800 786 232

 is a registered trademark.

'Brita' is a registered trademark.

Made in China.

Due to minor changes in design or otherwise, the product may differ from the one shown in this leaflet.

© Copyright. Sunbeam Corporation Limited 2013.

ABN 45 000 006 771

Units 5 & 6, 13 Lord Street
Botany NSW 2019 Australia

Unit 3, Building D
26 Vestey Drive
Mt Wellington Auckland
New Zealand

Sunbeam Corporation is a division of GUD Holdings Ltd.

Free Manuals Download Website

<http://myh66.com>

<http://usermanuals.us>

<http://www.somanuals.com>

<http://www.4manuals.cc>

<http://www.manual-lib.com>

<http://www.404manual.com>

<http://www.luxmanual.com>

<http://aubethermostatmanual.com>

Golf course search by state

<http://golfingnear.com>

Email search by domain

<http://emailbydomain.com>

Auto manuals search

<http://auto.somanuals.com>

TV manuals search

<http://tv.somanuals.com>