

*Sunbeam*

# Non-Stick Wok

5.0 litre heat wall non-stick wok

Instruction/Recipe Booklet

WW4500D

Please read these instructions carefully  
and retain for future reference.



# Contents

<b>Sunbeam's Safety Precautions</b>	<b>1</b>
<b>Features of your Non-Stick Wok</b>	<b>2</b>
<b>Using your Non-Stick Wok</b>	<b>6</b>
<b>Cooking Techniques</b>	<b>7</b>
<b>Care and Cleaning</b>	<b>9</b>
<b>Recipes</b>	<b>10</b>

تأكد من تفهم احتياطات السلامة المذكورة اعلاه

請務必理解上述的安全預防措施。

Assurez-vous que les précautions ci-dessus relatives à la sécurité sont bien comprises

Versichern Sie sich, dass die obenstehenden Sicherheitsmaßnahmen verstanden werden

Βεβαιώστε πως οι παραπάνω προφυλάξεις ασφαλείας γίνονται κατανοητές

Pastikan bahwa tindakan-tindakan keselamatan seperti di atas dimengerti anda

Accertatevi che le suddette norme di sicurezza siano comprese a dovere

上記の注意事項をよくお読みになり、安全を御確認ください

Уверете се дека погоре споменатите мерки на претпазливост се добро разбрани

Asegúrese de que las precauciones de seguridad precedentes sean bien comprendidas

کاری بکنید کہ احتیاط‌های بالا حتماً درک بشوند

ต้องแน่ใจว่า ข้อควรระวังเรื่องความปลอดภัยข้างต้น เป็นที่เข้าใจกันดี

Yukarda belirtilen güvenlik önlemlerinin anlaşıldığından emin olunuz

Xin kiểm chắc rằng những biện pháp làm an toàn kể trên được hiểu rõ

# Sunbeam's Safety Precautions

## SAFETY PRECAUTIONS FOR YOUR SUNBEAM WOK.

- Use well away from walls and curtains.
- Avoid using on metal surfaces e.g. sink, hotplate.
- Use caution when cooking foods such as chicken as the skin may pop during cooking.
- Do not touch cooking vessel whilst hot, use cool touch handles.
- If using a plastic spatula do not leave in cooking vessel when hot.
- Do not immerse control probe in water.
- Use only the supplied temperature control probe Type 910, Model TC0700 with this wok.

**Sunbeam is very safety conscious when designing and manufacturing consumer products, but it is essential that the product user also exercise care when using an electrical appliance. Listed below are precautions which are essential for the safe use of an electrical appliance:**

- Read carefully and save all the instructions provided with an appliance.
- Always turn the power off at the power outlet before you insert or remove a plug. Remove by grasping the plug - do not pull on the cord.
- Turn the power off and remove the plug when the appliance is not in use and before cleaning.
- Do not use your appliance with an extension cord unless this cord has been checked and tested by a qualified technician or service person.
- Always use your appliance from a power outlet of the voltage (A.C. only) marked on the appliance.
- This appliance is not intended for use by persons (including children) with reduced physical, sensory or mental capabilities, or lack of experience and knowledge, unless they have been given supervision or instruction concerning use of the appliance by a person responsible for their safety.
- Children should be supervised to ensure that they do not play with the appliance.
- The temperature of accessible surfaces may be high when the appliance is operating.
- Never leave an appliance unattended while in use.
- Do not use an appliance for any purpose other than its intended use.
- Do not place an appliance on or near a hot gas flame, electric element or on a heated oven.
- Do not place on top of any other appliance.
- Do not let the power cord of an appliance hang over the edge of a table or bench top or touch any hot surface.
- Do not operate any electrical appliance with a damaged cord or after the appliance has been damaged in any manner. If damage is suspected, return the appliance to the nearest Sunbeam Appointed Service Centre for examination, repair or adjustment.
- For additional protection, Sunbeam recommend the use of a residual current device (RCD) with a tripping current not exceeding 30mA in the electrical circuit supplying power to your appliances.
- Do not immerse the appliance in water or any other liquid unless recommended.
- Appliances are not intended to be operated by means of an external timer or separate remote control system.
- This appliance is intended to be used in household and similar applications such as: staff kitchen areas in shops, offices and other working environments; farm houses; by clients in hotels, motels and other residential type environments; bed and breakfast type environments.

If you have any concerns regarding the performance and use of your appliance, please visit [www.sunbeam.com.au](http://www.sunbeam.com.au) or contact the Sunbeam Consumer Service Line. Ensure the above safety precautions are understood.

# Features of your Non-Stick Wok

## Glass lid with adjustable steam vent

Allows you to monitor your cooking progress.

## Teflon® Platinum Pro™ non-stick coating

DuPont's most durable and damage resistant non-stick coating to date. Three layers of premium non-stick coating for superior scratch resistance. Safe to use with metal utensils.

## 2000 watt 'heat-wall' element

The element wraps around the heavy duty base and sides of the wok providing superior heat distribution over the entire cooking surface.

## Detachable 'cook and clean' base

Quick release for easy cleaning. Simply turn to unlock the release dial.

## Steaming rack

Ideal for steaming fish, vegetables or dumplings for fast, healthy, fat-free cooking.

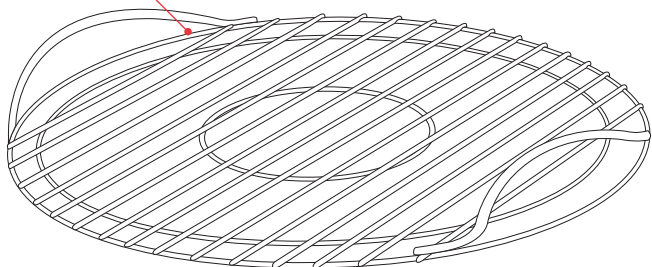
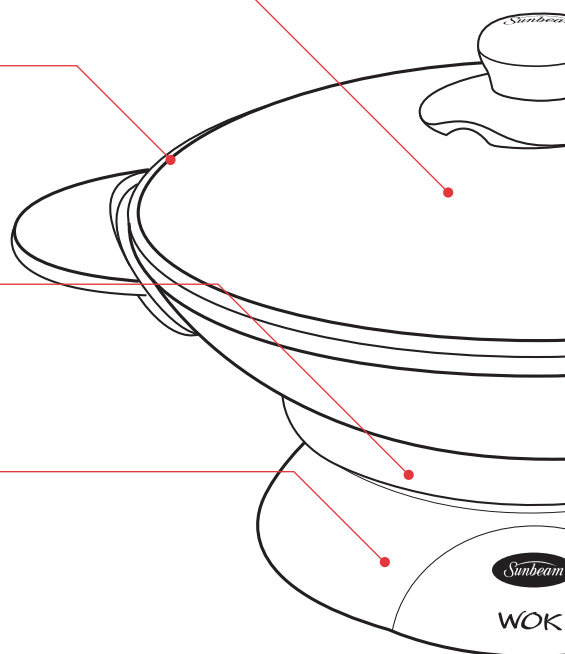

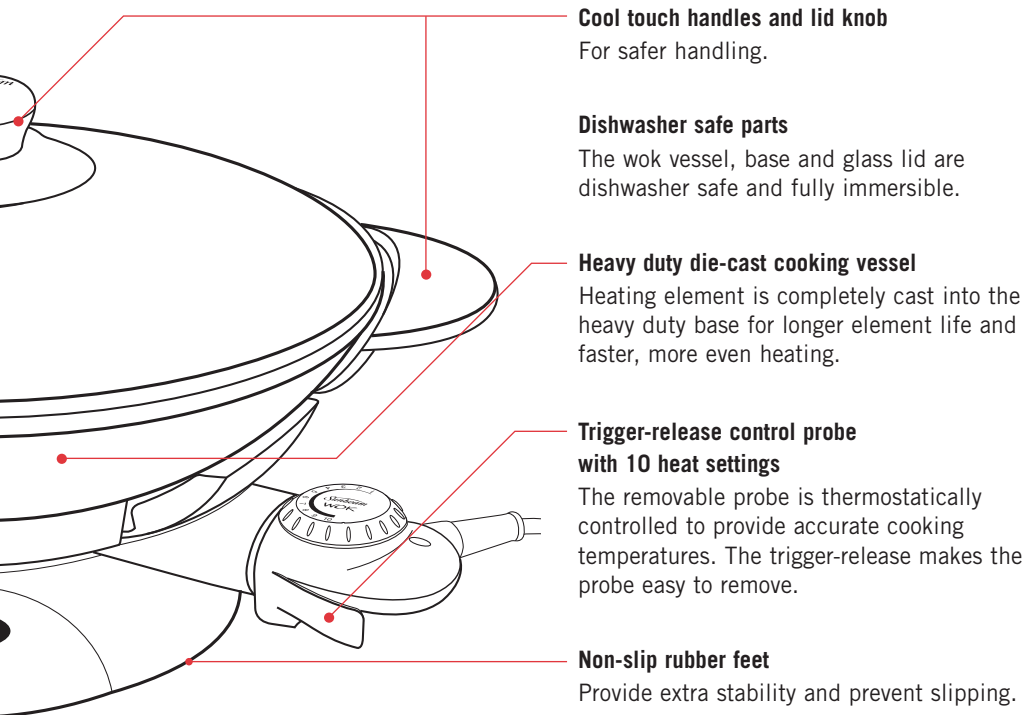

# DuPont Teflon® Platinum Pro™ Professional Use



Your Sunbeam Non-Stick Wok features a special scratch and abrasive-resistant non-stick cooking coating that makes it safe to use metal utensils when cooking. Teflon® Platinum Pro™ – Professional Use is DuPont's toughest non-stick coating to date – up to 10 times more scratch resistant than single layer non-stick coatings.\*

DuPont is the world leader in non-stick coatings and today more than 2 billion households have Teflon® non-stick coated cookware.

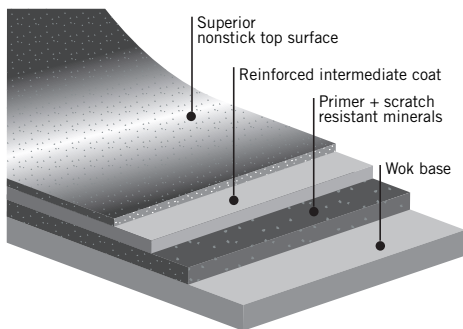

*Teflon® Platinum Pro™ – 3 layer scratch resistant coating*

Teflon® Platinum Pro™ is a premium 3 layer non-stick coating. It features special scratch resistant minerals causing metal utensils to slide over these particles without damaging the Teflon® matrix. This preserves the release properties of the non-stick coating and the life of the Non-Stick Wok.

The result is a non-stick coating that can be treated like ordinary cookware, enabling the use of metal utensils. However, Sunbeam recommends that care is taken with the non-stick coating when using metal utensils.

Do not use sharp objects or cut food inside the Non-Stick Wok. Damage caused to your Non-Stick Wok as a result of misuse of metal utensils will void your warranty.

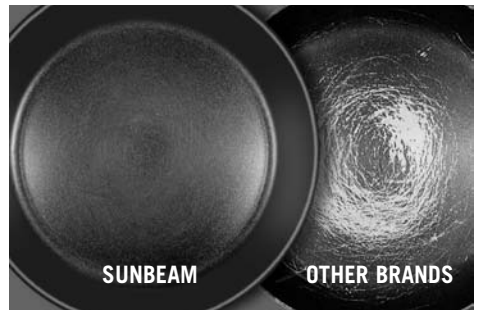

*Results from DuPont's 'In-house Cooking Abuse Test'*

*\* The images shown here and performance claims are based upon the DuPont In-house Cooking Abuse Test used to evaluate scratch resistance and release properties of non-stick coatings.*

# Features of your Non-Stick Wok

## 2000 Watt 'Heat Wall' Element

Your Sunbeam Non-Stick Wok features a special 2000 watt 'heat-wall' element. This element wraps around the base and side walls of your wok providing superior cooking temperatures and heat distribution.

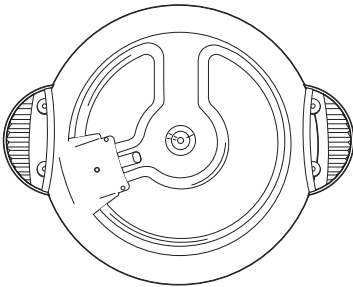

*Completely cast-in element*

The heat is quickly channelled from the base of the wok up the side walls. This 'heat-wall' system creates the ideal wok cooking environment for fast and easy cooking.

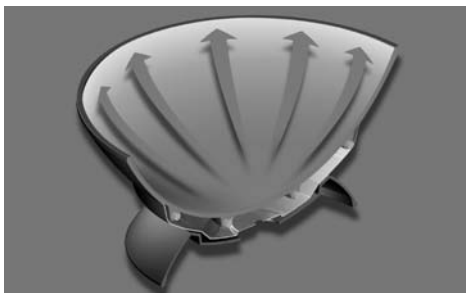

*Heat-Wall element channels heat upwards*

The 'heat-wall' element is completely cast into the heavy duty base. This increases the life of the element and provides faster heat distribution.

## Trigger-Release Control Probe with 10 Heat Settings

The heat control probe is thermostatically controlled with 10 settings to deliver perfect cooking control.

The indicator light switches 'on' when it is heating. When the wok has reached the desired temperature the indicator light switches 'off'. The indicator light will then cycle 'on' and 'off' as the thermostat maintains the set temperature.

The heat control probe is ergonomically designed with a handy trigger-release. Simply hold the probe and squeeze the trigger with your thumb to remove it.

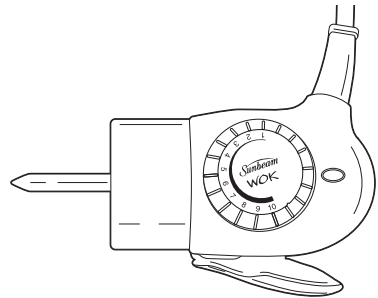

*Heat control probe with trigger release*

# Using your Non-Stick Wok

## Before First Use

Ensure any stickers are removed from the product. Wash in warm soapy water, rinse thoroughly and dry your wok and lid.

## Do not immerse the heat control probe in water or any other liquid.

1. Insert the heat control probe into the socket of the wok.
2. Plug the cord into a 230-240V power outlet and turn the power on.
3. Set the heat control probe dial to the desired temperature setting, or the recommended temperature setting for your required recipe.

Allow 5 minutes for your wok to reach the temperature setting you have selected. The wok is now ready to use.

**Note:** The thermostat light on the heat control probe indicates the temperature at which the dial is set.

This light will remain on until the set temperature has been reached and then will cycle on and off throughout cooking. This will ensure that the wok maintains the correct temperature.

## Detachable Cook & Clean Base

Your Sunbeam Non-Stick Wok features a quick release detachable 'Cook & Clean' base. This enables the base to be quickly and easily removed from the wok cooking vessel.

Simply turn the wok upside down and turn the release dial anti-clockwise as shown in the illustration below.

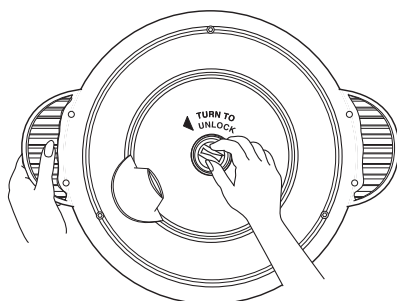

*Quick-release 'cook and clean' base*



# Cooking Techniques

Various cooking methods can be used to make a wide variety of foods in your Sunbeam Non-Stick Wok.

## Stir-Frying

Stir-frying is a quick cooking method conducted over very high heat. The wok should be hot before adding oil or any ingredients. Be sure to maintain maximum heat when stir-frying by cooking food in small batches. Use a constant tossing motion to ensure the food is evenly exposed to the heat and does not burn.

## Tips When Stir-Frying

- Meat should be cooked in batches, approximately 150g per batch. This prevents the temperature of the wok dropping too low and also prevents the meat from stewing. Once the meat is cooked, remove it from the wok and continue cooking other ingredients like vegetables, sauce and noodles. Then return the meat to the wok to heat through.
- Vegetables and meat should be cut into uniform shapes and sizes before starting, as stir-frying relies on quick cooking for best results.
- Slice meats into thin strips (about 5cm long) so that they can cook quickly.
- If stir-frying marinated meat strips, drain off excess marinade as it tends to boil, which toughens the meat.
- Ensure the oil has been preheated to the correct temperature before cooking.
- Suitable oils for stir-frying include canola, sunflower, peanut or light olive oils.
- Stir-frying is done quickly. The shorter the cooking time, the less chance there is for the meat to toughen or overcook. This also keeps the food crisp and full of nutrients.

- Do not use the lid when stir-frying as stir-frying is a method of dry cooking and the steam droplets will toughen the meat.
- Serve stir-fried foods immediately to retain their crisp texture.

## Shallow Frying

Shallow frying is a method used to cook and crispen foods in a small amount of oil. The food is cooked at a lower temperature so that a brown crust forms on the underside. The food is then turned over to brown the other side. Usually 1 cup of oil is sufficient for shallow frying.

## Deep Frying

Deep fried foods should be crispy on the outside and tender on the inside. The food should be coated with batter or breadcrumbs and placed in a larger quantity of hot oil.

## Tips When Deep Frying

- Preheat the oil to the desired temperature before adding food.
- Do not cover the wok with the lid when deep frying. This will prevent foaming or splattering of oil from condensation droplets.
- Wipe moisture from foods to avoid any splattering or foaming of oil.
- Do not fill the wok with more than 800mls of oil. For best results use a vegetable oil for sweet foods and peanut oil for Asian style foods.
- Food should be fried in batches, a few pieces at a time. This prevents the oil temperature from dropping too low and also prevents a soggy crust from forming on food.
- Drain the food on paper towel as soon as it is removed from the oil.
- Always allow the oil to cool completely before removing from the wok.

# Cooking Techniques

## Steaming

Steamed foods are tender and juicy, retaining most of their nutritional value. Most foods are suitable for steaming, including fish, seafood, chicken, vegetables, buns and dumplings.

When steaming, foods can cook very quickly so be sure to monitor your cooking progress. Place food on the steaming rack provided and place in wok over simmering water or stock. Cover with glass lid.

**Note:** The liquid should only be just simmering. If the heat is too high it may cause the liquid to bubble up over the food. Heat settings 2-3 should be sufficient.

## Stewing and Braising

The wok can be used on a low heat to make your favourite stews and casseroles. The lid should be left on when stewing.

Braising is a variation to stir-frying where liquid is added at the end of stir-frying and the ingredients are left to simmer, usually uncovered.

# Care and Cleaning

Always turn the power **OFF** and **REMOVE** the plug from the power outlet before cleaning. Remove the control probe from the socket of the wok.

## **Teflon® Platinum Pro™ Non-Stick Coating**

Your wok features a special scratch and abrasive-resistant non-stick coating that makes it safe to use metal utensils when cooking.

However Sunbeam recommends that care is taken with the non-stick coating particularly when using metal utensils.

Do not use sharp objects or cut food inside the wok vessel. Sunbeam will not be liable for damage to the non-stick coating where metal utensils have been misused.

When cleaning the non-stick coating do not use metal (or other abrasive) scourers. After cleaning, dry the wok and lid thoroughly with a soft cloth before storing.

## **Heat Control Probe**

If cleaning is necessary, wipe over probe with a damp cloth.

**Do not immerse the control probe in water or any other liquid.**

## **Storage**

Store the control probe carefully in a safe place. Do not knock or drop it as this can damage the probe.

If damage is suspected, return the control probe to your nearest Sunbeam Service Centre for inspection.

## **Wok, Base and Glass Lid**

The wok, base and lid are fully immersible and can be washed in warm soapy water using a mild household detergent and a soft washing sponge.

For added convenience, they can also be cleaned in the dishwasher. Do not place the control probe in the dishwasher.

## **Removing Stubborn Stains**

Should your wok require additional cleaning of stubborn stains and build-up, the following method is recommended:

Combine: 2 tablespoons bicarbonate of soda and 2 teaspoons water.

1. Pre-heat the wok for approximately 1-1½ minutes on setting 3.
2. Turn the power OFF and remove the plug from the power outlet. Brush the above paste solution onto the non-stick surface, allow to stand for 1 hour.
3. Wash the wok in warm soapy water using a mild household cleaner and a soft washing sponge.

Dry with a soft cloth before storing.

## **To Clean Steaming Rack**

Wash in warm soapy water using a mild household detergent. Rinse thoroughly and dry with a soft cloth before storing.

# Recipes

## Arancini - Cheese Filled Risotto Balls

**Makes: 24**

**Preparation: 20 minutes**

**Cooking: 45 minutes**

2 cups chicken stock

½ cup water

1 tablespoon olive oil

1 small brown onion, chopped finely

1 garlic clove, crushed

¾ cup arborio rice

2 tablespoons finely chopped basil

2 tablespoons finely grated parmesan

40g mozzarella, cut into 1cm pieces

¼ cup breadcrumbs

Vegetable oil, for deep frying

1. Combine stock and water in large microwave safe jug. Microwave on HIGH (100%) for 1 minute.
2. Heat wok on setting 4. Add oil and sauté onion and garlic until softened. Add rice and 1 cup of combined stock and water mixture, cook, stirring occasionally until mixture is absorbed. Continue adding stock mixture in batches until liquid is absorbed after each addition. Cooking time should be about 30 minutes.

**Note:** Heat setting may need to be varied during cooking.

3. Stir in basil and parmesan. Place mixture into a large bowl to cool. Clean wok for deep frying.
4. Roll level tablespoons of risotto into balls, press a piece of cheese into the centre and roll to enclose. Coat balls in breadcrumbs.
5. Using the clean wok, heat oil on setting 9-10 until hot.

**Note:** See tips on deep frying in a wok on page 7.

6. Deep fry balls in batches for 1-2 minutes or until golden brown and heated through; drain on paper towelling.

## Vegetarian Curry Puffs

**Makes: 54**

**Preparation: 30-40 minutes**

**Cooking: 15-20 minutes**

2 teaspoons vegetable oil

1 medium brown onion, chopped finely

2 cloves garlic, crushed

1 tablespoon mild curry paste

2 medium (350g) potatoes, peeled and finely diced

1 small (140g) carrot, finely diced

2 tablespoons mango chutney

2 tablespoons water

½ cup frozen peas

6 sheets ready rolled puff pastry

1 egg, beaten lightly

Peanut oil, for deep frying

Sweet chilli sauce, to serve

1. Heat wok on setting 7. Add oil, onion and garlic, stir until onion has softened.
2. Stir in curry paste and cook until fragrant. Reduce heat to setting 3, stir in potatoes, carrots and mango chutney; cover and cook, stirring occasionally until the potatoes are tender. Add water if mixture is too thick. Stir through peas, cover and cook for a further 2-3 minutes. Transfer mixture to heatproof bowl and allow to cool. Clean wok for deep frying.
3. Using an 8cm pastry cutter, cut 9 rounds from each sheet of pastry.
4. Place a heaped teaspoon of mixture into the centre of rounds; brush edges with a little egg. Fold rounds in half and pinch edges together to seal.
5. Heat oil on setting 9-10 until hot.

**Note:** See tips on deep frying in a wok on page 7.

## Recipes continued

6. Deep fry curry puffs in batches for 3-4 minutes or until golden brown. Drain on paper towelling.

7. Serve with sweet chilli sauce.

**Tip:** Prepared curry puffs can be frozen and thawed again for frying. Recipe can also be halved for a smaller quantity.

### Steamed Pork Buns

**Makes:** 6

**Preparation:** 20 minutes (+ 1 hour proving time)

**Cooking:** 10 minutes

200g Chinese style BBQ pork

¼ cup hoi sin sauce

1 tablespoon salt-reduced soy sauce

1 garlic clove, crushed

½ teaspoon sesame oil

¼ teaspoon Chinese five spice powder

#### Dough

1 ¼ cups plain flour

2 tablespoons caster sugar

2 teaspoons dried yeast

¼ cup warm milk

¼ cup lukewarm water

1 ½ tablespoons vegetable oil

1. To make the dough, combine the flour, sugar and yeast in a large bowl. Make a well in the centre. Combine the milk, water and 1 tablespoon of the oil in a jug. Add to dry ingredients and stir to combine.

2. Turn dough out onto a lightly floured surface; knead for 5 minutes or until smooth. Use remaining oil to lightly grease a large bowl. Place dough in bowl and turn to coat in oil. Cover with plastic wrap and place in a warm, draught-free place to prove for 30 minutes or until dough doubles in size.

3. Meanwhile, trim any fat from pork and finely chop. Combine sauces, garlic, oil and spice in a bowl; stir through pork and set aside.

4. Punch dough down with your fist, knead briefly on a lightly floured surface and cover with plastic wrap. Place in a warm draught-free area to prove for a further 30 minutes.

5. Shape dough into a 5 x 20cm log. Cut into six equal portions. Use a round 7cm pastry cutter as a guide to cut six discs from non-stick baking paper.

6. Flatten each dough portion. Place equal amounts of pork mixture on centre of dough and bring side of dough up to enclose. Roll into a ball. Place bun, seam-side down, on paper. Cut a small cross in the top of each bun. Arrange buns on steamer rack.

7. Pour approximately 1 cup of water into the base of the wok. Place steamer rack into wok. Cover with lid and turn wok onto setting 3. Once water starts to simmer, cook buns for 10 minutes or until dough is cooked.

**Tip:** Chinese BBQ pork can be bought from some Asian food stores.

## Recipes continued

### Thai Fish Cakes

**Serves:** 4-6 as an entrée

**Preparation:** 15 minutes

**Cooking:** 20 minutes

- 500g red fish fillets
- 2-3 tablespoons red curry paste
- 1 teaspoon sugar
- 2 tablespoons fish sauce
- 2 egg whites
- ½ cup thinly sliced snake beans
- 2 kaffir lime leaves, shredded
- Peanut oil, for deep frying

### Dipping Sauce

- ½ cup white sugar
- ½ cup water
- ½ cup white vinegar
- 1 large red chilli, thinly sliced
- 1 tablespoon chopped fresh coriander
- 1 tablespoon finely chopped roasted peanuts

1. Remove any bones from fish and roughly chop.
2. Combine fish, red curry paste, sugar, fish sauce and egg whites in a food processor. Process until mixture is combined.
3. Place mixture into a bowl and stir through beans and lime leaves.
4. Heat oil in wok on setting 9-10 until oil is hot.

**Note:** See tips on deep frying in a wok on page 7.

5. Using two dessertspoons carefully drop spoonfuls of fish mixture into the oil – about 6-7 at a time. Cook fish for 2-3 minutes until cooked through. Drain on paper towelling and repeat with remaining mixture.
6. Serve with dipping sauce.

**Dipping sauce:** Combine sugar, water and vinegar in a small saucepan. Stir over a low heat until sugar dissolves. Increase heat and simmer mixture for 5 minutes. Remove from heat and allow to cool. Stir through chilli, coriander and nuts.

### Honey Chilli Chicken Wings

**Serves:** 4-6

**Preparation:** 10 minutes

**Cooking:** 15 minutes

- 1.2kg chicken wings
- ½ cup plain flour
- Salt and pepper
- Peanut oil, for deep frying
- Green onions, to serve

### Honey Chilli Sauce

- 1 tablespoon grated fresh ginger
- 2 tablespoons honey
- 2 teaspoons cornflour
- 1 tablespoon water
- 2 tablespoons shao hsing cooking wine
- 2 tablespoons sweet chilli sauce
- 2 tablespoons lemon juice
- 2 teaspoons soy sauce

1. Cut wings in half and trim tips. Coat chicken in flour that has been seasoned with salt and pepper.
2. Heat oil in wok on setting 9-10.

**Note:** See tips on deep frying in a wok on page 7. Always use caution when deep frying foods such as chicken as the skin may pop during cooking.

3. Fry wings in batches until golden and just cooked through. Drain on paper towelling. Cover and keep warm.

## Recipes continued

4. Turn wok off and allow oil to cool before carefully removing oil from wok and wipe clean. Heat wok on setting 7; add 1 tablespoon of fresh oil to the wok. Add ginger and cook for 1 minute. Add honey and cook for a further minute. Add the combined remaining ingredients and stir until sauce boils and thickens.
5. Add chicken and stir until chicken is well coated and warmed through. Garnish with thinly slice green onions.

**Tip:** Shao Hsing is a Chinese cooking wine and is available from Asian supermarkets. If unavailable then recipe can be substituted with sweet sherry.

### **Sang Choy Bao**

**Serves: 4 as an entrée**

**Preparation: 10 minutes**

**Cooking: 8 minutes**

- 3 green onions
- 1 tablespoon peanut oil
- 1 clove garlic, crushed
- ½ teaspoon grated fresh ginger
- 6 fresh shiitake mushrooms, chopped finely
- 10 water chestnuts, chopped finely
- 350g lean chicken or pork mince
- 4 lettuce leaves, to serve
- 2 teaspoon sesame seeds, toasted

#### **Sauce**

- 1 tablespoon shao hsing cooking wine
- 1 tablespoon light soy sauce
- 1 tablespoon oyster sauce
- 1 tablespoon hoisin sauce
- 1 teaspoon sesame oil
- 1 teaspoon white sugar

1. Separate white and green parts of onions. Finely chop the white parts and thinly slice the green. Keep separate and set aside.
2. Heat oil in a wok on setting 10; add garlic, ginger, mushrooms, water chestnuts and white parts of green onions and cook, stirring frequently for 1 minute.
3. Add chicken mince and cook 3-4 minutes or until golden and crumbly.
4. Combine sauce ingredients in a separate bowl, mix well. Pour into chicken mince and stir-fry for 3 minutes or until chicken mince is cooked and sauce has thickened. Stir through green parts of green onions.
5. Spoon into lettuce cups, sprinkle with sesame seeds and serve immediately.

**Tip:** Shao Hsing is a Chinese cooking wine and is available from Asian supermarkets. If unavailable then recipe can be substituted with sweet sherry.

## Recipes continued

### Fried Rice

**Serves:** 4

**Preparation:** 20 minutes

**Cooking:** 10 minutes

- 3 green onions
  - 2 tablespoons peanut oil
  - 4 eggs, lightly whisked
  - 175g rindless bacon rashers
  - 1 small red capsicum, seeded, chopped finely
  - ¾ cup fresh or frozen peas
  - 4 cups cold cooked rice (see tip)
  - 2 tablespoons soy sauce
  - 2 tablespoons oyster sauce
  - 250g small cooked prawns, peeled and deveined
  - 2 cups shredded wom bok cabbage
  - White pepper, to taste
1. Slice green onions and separate white and green parts; set aside.
  2. Heat wok on setting 4. Add 1 teaspoon of the oil and pour one quarter of the egg mixture into the wok; carefully swirl the wok around to spread the egg into a thin omelette. Cook for 1-1 ½ minutes without turning over. Repeat with remaining egg to make 4 omelettes. Roll omelettes up and thinly slice.
  3. Increase heat to setting 9; add bacon and cook until browned; set aside.
  4. Add remaining oil to the wok and cook the white parts of the onions for 1 minute. Add the capsicum and peas and cook for a further 1 minute. Add the rice, sauces and prawns to the wok and stir fry until the rice has warmed through, then return the bacon to the wok together with the cabbage, green parts of the onions and the omelette. Season with ground white pepper.

**Tip:** Cook the rice the day before or several hours in advance as per the directions on the packet. Rinse rice and drain well then layer on a tray lined with baking paper; cover with paper towelling and refrigerate.

### Chicken Laksa

**Serve:** 4

**Preparation:** 15 minutes

**Cooking:** 10 minutes

- 3-4 tablespoons laksa paste
  - 1 clove garlic, crushed
  - 2 cups chicken stock
  - 2 cups coconut milk
  - 300g cooked chicken, roughly chopped
  - 150g store bought fried tofu (optional)
  - 250g rice vermicelli noodles, cooked and drained
  - 100g bean sprouts
  - ½ cup fresh coriander leaves
  - ⅓ cup packaged fried shallots
1. Heat wok on setting 7. Add paste and garlic and stir fry for 1-2 minutes or until fragrant. Add stock and coconut milk and simmer, stirring occasionally for 3-5 minutes.
  2. Add chicken and tofu to liquid and cook until heated through.
  3. Divide warm noodles among four bowls. Ladle liquid with chicken and tofu among the bowls. Top with bean sprouts, coriander leaves and fried shallots.

**Tip:** Fried shallots are available from Asian grocers and some good supermarkets.



## Recipes continued

### Pad Thai

**Serves:** 4

**Preparation:** 15 minutes

**Cooking:** 10 minutes

200g rice stick noodles

200g firm tofu

¼ cup vegetable oil

3 eggs

500g large green prawns, peeled and deveined

⅓ – ½ cup Pad Thai paste

1 bunch garlic chives, cut into 4cm pieces

100g bean sprouts

¼ cup packaged fried shallots

¼ cup chopped peanuts

½ cup fresh coriander leaves

Lime wedges, to serve

1. Soak noodles in a large bowl of cold water for 20 minutes; drain and set aside. Cut the tofu into 2 thick slices and pat dry with paper towelling.
2. Heat 2 tablespoons of the oil in wok on setting 8; cook tofu one piece at a time until golden on both sides; drain on paper towelling. Cut tofu into small pieces, about 1cm.
3. Break eggs into a small bowl.
4. Turn wok off and carefully wipe out and remaining oil with paper towelling.
5. Heat wok on setting 7. Add remaining oil and cook prawns until just cooked. Remove from heat and set aside.
6. Add paste to wok and stir fry for 1 minute or until fragrant. Add noodles and cook, stirring until the noodles are coated in the paste. Push the noodles to one side and pour eggs into wok. Stir eggs together until the base starts to cook then stir eggs into noodles. Add tofu, prawns, chives, bean sprouts and fried shallots and stir through. Top with nuts and coriander leaves. Serve with lime wedges.

**Note:** There are several types of Pad Thai pastes. We used the Valcom brand which is available in supermarkets. Fried shallots are available from Asian grocers and some good supermarkets.

### Mussels in White Wine and Garlic

**Serves:** 4

**Preparation:** 10 minutes

**Cooking:** 7-10 minutes

2 kg black mussels

1 tablespoon olive oil

3 eschalots, chopped finely

3 cloves garlic, chopped finely

1 cup white wine

½ cup chopped fresh parsley

100g unsalted butter, chopped

Freshly ground black pepper

Sliced ciabatta bread, to serve

1. Clean mussels and debeard.
  2. Heat wok on setting 7 then add oil. Add eschalots and garlic and cook, stirring until softened. Add the mussels and wine; cover and increase heat to setting 10. Cook mussels with lid on for about 2 ½ minutes, stirring once, until the mussels have opened. Remove mussels and set aside. Add the butter and parsley and cook for another few minutes until the butter has melted and the sauce has thickened.
- Note:** Some mussels release a lot of liquid. Reduce liquid down for a few minutes before adding butter if desired.
3. Spoon mussels into bowls and carefully spoon over liquid; season with pepper. Serve with crusty bread.

### **Rendang Daging – Spicy Coconut Beef Curry**

**Serves:** 6

**Preparation:** 30 minutes

**Cooking:** 1 ½ hours

- 1.5kg chuck steak
- ½ cup desiccated coconut
- 1 teaspoon ground coriander
- ¼ teaspoon ground turmeric
- 4 kaffir lime leaves, shredded
- 400ml coconut milk
- 2 tablespoons fish sauce
- Sea salt

#### **Curry Paste**

- 8 dried long red chillies
- 4 cloves garlic, roughly chopped
- 8 eschalots, roughly chopped
- 1 lemon grass stalk, white only, sliced
- 2cm piece fresh ginger, peeled, roughly chopped
- 2cm piece fresh galangal, peeled, roughly chopped
- pinch sea salt

1. To make curry paste, remove stem and seeds from chillies, soak chillies in hot water until just softened; roughly chop. Place all curry paste ingredients in a food processor and process to a smooth paste; add a little water if necessary.
2. Trim fat from beef and cut into 3cm pieces.
3. Heat wok on setting 4; lightly toast coconut, stirring, until lightly golden; remove from heat and allow to cool. Once cool, process in a food processor to a fine powder.
4. Heat wok on setting 3; add curry paste, coriander, turmeric and lime leaves and cook, stirring, for about 5 minutes or until fragrant.
5. Add beef and stir until browned. Add desiccated coconut, coconut milk and fish sauce into the wok and stir to combine.

6. Reduce heat to setting 2 and simmer, stirring occasionally for about 1 ½ hours or until beef is tender and sauce is a rich brown colour and has thickened. Season with salt.

**Tip:** If the sauce has thickened too much before the meat is tender then add 2-3 tablespoons of water and reduce again.

### **Beef with Cashews and Hokkien Noodles**

**Serves:** 4

**Preparation:** 15 minutes

**Cooking:** 10 minutes

- 500g rump steak, sliced thinly
  - 2 tablespoons peanut oil
  - 1 onion, sliced
  - 2 cloves garlic, crushed
  - 2 teaspoons grated fresh ginger
  - 1 bunch gai lan (Chinese broccoli), washed and roughly sliced
  - 400g fresh hokkien noodles
  - 2 tablespoons light soy sauce
  - 1 tablespoon honey
1. Combine beef with 1 tablespoon of the oil in a bowl; mix well to coat beef in oil.
  2. Heat wok on setting 9. Cook beef in batches until browned. Set aside.
  3. Reduce heat to setting 7. Add remaining oil to wok; add onion and garlic and stir fry for 1 minute. Add gai lan and stir fry for 1 minute then return beef to wok with noodles, soy and honey. Stir fry until noodles are heated through.
  4. Serve immediately.

### Thai Red Curry Chicken Stir Fry

**Serves: 4**

**Preparation: 15 minutes**

**Cooking: 5 minutes**

2 large chicken breast fillets  
2 tablespoons vegetable oil  
4 eschalots, sliced  
2-3 tablespoons red curry paste  
1 small red capsicum, sliced  
125g fresh baby corn, halved  
150g baby green beans, trimmed and halved  
270ml light coconut milk  
4 kaffir lime leaves, shredded  
2 teaspoons white sugar  
¼ cup chopped fresh coriander  
Jasmine rice, to serve

1. Slice chicken into thin slices. Place chicken in a medium bowl and stir through 1 tablespoon of the oil.
2. Preheat wok on setting 9. Stir fry chicken in batches until golden brown; set aside.
3. Add remaining oil to wok and cook eschalots until softened. Add curry paste and stir fry until fragrant. Add the vegetables and cook for 1-2 minutes then add the chicken and remaining ingredients except for the coriander to the wok. Cook, stirring, until chicken is cooked. Sprinkle with coriander and serve with steamed jasmine rice.

### Mongolian Lamb

**Serves: 4**

**Preparation: 15 minutes + marinating time**

**Cooking: 10 minutes**

800g lamb backstraps, sliced  
3 cloves garlic, crushed  
1 tablespoon cornflour  
¼ cup dark soy sauce  
⅓ cup shao hsing cooking wine  
1 tablespoon oil  
1 medium brown onion, sliced  
1 green capsicum, sliced  
1 tablespoon sugar  
1 teaspoon sesame oil  
4 green onions, thinly sliced

1. In a large bowl, combine the lamb, garlic, cornflour, soy sauce and wine. Mix well to combine; refrigerate for 1 hour.
2. Strain liquid from lamb and reserve liquid. Heat wok on setting 10. Add oil and cook lamb in small batches, until browned; set aside.
3. Add onion and capsicum to wok and stir fry for 1 minute. Return lamb to wok with sugar, sesame oil and reserved liquid.
4. Cook until sauce thickens and lamb has warmed through. Serve with green onions.

**Tip:** Shao Hsing is a Chinese cooking wine and is available from Asian supermarkets. If unavailable then recipe can be substituted with sweet sherry.

### Japanese Stir-Fry Pork

**Serves: 4**

**Preparation: 10 minutes + marinating time**

**Cooking: 5-7 minutes**

700g pork fillet

2 tablespoons mirin

2 tablespoons vegetable oil

1 onion, sliced

1 clove garlic, crushed

1 carrot, sliced

150g sugar snap peas

¼ cup teriyaki sauce

Rice, to serve

1. Trim any fat from pork and finely slice. Place pork in a small glass bowl and stir through mirin. Cover and refrigerate for 2-3 hours.
2. Remove pork from refrigerator, stir through 1 tablespoon of the oil and allow to sit at room temperature for 20 minutes.
3. Heat wok on setting 10. Stir fry pork in batches until browned; set aside.
4. Reduce heat to setting 7. Add remaining oil to wok; add onion and cook for 1 minute, add garlic and carrot and cook for a further 2-3 minutes. Add pork, sugar snap peas and teriyaki to wok and stir fry for 1-2 minutes or until pork is cooked and vegetables are just tender. Do not over cook.
5. Serve with rice.

### Chinese Style Tofu and Green Vegetables

**Serves: 4**

**Preparation: 10 minutes**

**Cooking: 5-7 minutes**

300g firm tofu

2 tablespoons peanut oil

1 onion, sliced

2 cloves garlic, crushed

2 small zucchini, sliced

3 bok choy, trimmed and quartered

100g enoki mushrooms, ends trimmed and pulled into small bunches

2 tablespoons oyster sauce

1 tablespoon sweet chilli sauce

1 tablespoon light soy sauce

1. Cut the tofu into 2 thick slices and pat dry with paper towelling.
2. Heat oil in the wok on setting 8; cook tofu one piece at a time until golden on both sides; drain on paper towelling. Cut each slice into 6 pieces.
3. Add onions to wok and stir fry for 1 minute. Add garlic and cook for a further minute. Add the zucchini and bok choy and cook for 1-2 minutes or until the zucchini starts to soften.
4. Add the mushrooms and the sauces and cook for a further 1 minute. Stir through the tofu and serve immediately.

## Recipes continued

### Cinnamon Doughnuts

**Makes:** 14

**Preparation:** 20 mins + proving

**Cooking:** 10 mins

- 2 teaspoons dry yeast
- 1 ¼ cups buttermilk or milk, warmed
- ¼ cup caster sugar
- 4 cups plain flour
- 1 teaspoon salt
- ¼ cup light olive oil
- 2 eggs, lightly beaten
- Vegetable oil, for deep frying

### Cinnamon Sugar

- 1 cup caster sugar
- 2 teaspoons ground cinnamon

1. In a small bowl, whisk the yeast into the warmed milk with 1 tablespoon of the sugar. Mix well and stand in a warm place for 10 minutes or until the mixture begins to bubble.
2. Sift the remaining sugar, flour and salt into a large bowl. Make a well in the centre and mix through the oil, eggs and yeast mixture. Mix to a soft dough.
3. Place mixture onto a lightly floured surface and knead dough for about 10 minutes or until dough is smooth and elastic.
4. Place dough in a bowl; cover, and stand in a warm place for about 40 minutes or until dough has doubled in size.
5. Turn dough onto a lightly floured surface and knead again until smooth and elastic. Roll dough out to a 1 cm thickness for a thinner doughnut or to a 1 ½ cm thickness for a thicker doughnut. To cut doughnuts use either a doughnut cutter or a 9cm cutter and a 3cm cutter. Place doughnuts onto a tray lined with baking paper and cover with plastic wrap, stand in a warm place for about 20 minutes.

6. Heat oil in wok on setting 9-10.

**Note:** See tips on deep frying in a wok on page 7.

7. Cook doughnuts, in batches, turning once during cooking, until golden in colour.
8. Drain doughnuts on paper towelling then toss in cinnamon sugar mixture.

### Banana Fritters

**Serves:** 4

**Preparation:** 10 minutes

**Cooking:** 5 minutes

- ½ cup plain flour
- ¼ cup cornflour
- 2 teaspoons sugar
- 1 egg
- ⅓ cup cold water
- 4 medium bananas
- Vegetable oil, for deep frying
- Icing sugar for dusting
- Ice cream, to serve

1. Sift flours and sugar into a large bowl. Make a well in the centre and whisk through combined egg and water.
2. Heat oil on setting 9-10 until hot.  
**Note:** See tips on deep frying in a wok on page 7.
3. Cut bananas in half lengthways. Dip halves, one at a time, into batter. Carefully lower banana halves into oil in batches. Fry for 1-2 minutes or until golden. Drain on paper towelling.
4. Serve fritters dusted with icing sugar and serve with ice cream.

# Notes

# 12 Month Replacement Guarantee

In the unlikely event that this appliance develops any malfunction within 12 months of purchase (3 months commercial use) due to faulty materials or manufacture, we will replace it for you free of charge.

Should you experience any difficulties with your appliance, please phone our customer service line for advice on 1300 881 861 in Australia, or 0800 786 232 in New Zealand. Alternatively, you can send a written claim to Sunbeam at the address listed below. On receipt of your claim, Sunbeam will seek to resolve your difficulties or, if the appliance is defective, advise you on how to obtain a replacement or refund.

Your Sunbeam 12 Month Replacement Guarantee naturally does not cover misuse or negligent handling and normal wear and tear.

Similarly your 12 Month Replacement Guarantee does not cover freight or any other costs incurred in making a claim. Please retain your receipt as proof of purchase.

The benefits given to you by this guarantee are in addition to your other rights and remedies under any laws which relate to the appliance.

Our goods come with guarantees that cannot be excluded under the Australian Consumer Law and under the New Zealand Consumer Guarantees Act.

In Australia you are entitled to a replacement or refund for a major failure and for compensation for any other reasonably foreseeable loss or damage. You are also entitled to have the goods repaired or replaced if the goods fail to be of acceptable quality and the failure does not amount to a major failure.

Should your appliance require repair or service after the guarantee period, contact your nearest Sunbeam service centre.

For a complete list of Sunbeam's authorised service centres visit our website or call:

## **Australia**

[www.sunbeam.com.au](http://www.sunbeam.com.au)

**1300 881 861**

Units 5 & 6, 13 Lord Street  
Botany NSW 2019 Australia

## **New Zealand**

[www.sunbeam.co.nz](http://www.sunbeam.co.nz)

**0800 786 232**

26 Vestey Drive, Mt Wellington  
Auckland, New Zealand

## Need help with your appliance?

Contact our customer service team or visit our website for information and tips on getting the most from your appliance.

### **In Australia**

Visit [www.sunbeam.com.au](http://www.sunbeam.com.au)

Or call 1300 881 861

### **In New Zealand**

Visit [www.sunbeam.co.nz](http://www.sunbeam.co.nz)

Or call 0800 786 232

 is a registered trademark.

'Non-Stick Wok' is a trademark of Sunbeam Corporation.

Made in China.

Due to minor changes in design or otherwise, the product may differ from the one shown in this leaflet.

© Copyright. Sunbeam Corporation Limited 2011.

ABN 45 000 006 771

Units 5 & 6, 13 Lord Street  
Botany NSW 2019 Australia

Unit 3, Building D  
26 Vestey Drive  
Mt Wellington Auckland  
New Zealand

Sunbeam Corporation is a division of GUD Holdings Ltd.



## Free Manuals Download Website

<http://myh66.com>

<http://usermanuals.us>

<http://www.somanuals.com>

<http://www.4manuals.cc>

<http://www.manual-lib.com>

<http://www.404manual.com>

<http://www.luxmanual.com>

<http://aubethermostatmanual.com>

Golf course search by state

<http://golfingnear.com>

Email search by domain

<http://emailbydomain.com>

Auto manuals search

<http://auto.somanuals.com>

TV manuals search

<http://tv.somanuals.com>