

## CARE AND OPERATION INSTRUCTIONS

### B-Vent Gas Fireplaces SLBV 35/40 Models

MODELS		MILLIVOLT:	ELECTRONIC:
SLBV-35NM	SLBV-40NM		SLBV-35NE
SLBV-35PM	SLBV-40PM		SLBV-40NE

WHAT'S INSIDE	
Table of Contents	2
<b>Safety and Your Fireplace</b>	2
FREE Safety Guard Offer (Protects Against Burns)	2
<b>Important Safety Information</b>	4
<b>Attaching the Safety-in-Operation Warnings</b>	5
[EN FRANÇAIS] L'information de sûreté importante	3-4
Apposition des mises en garde relatives à la sécurité d'utilisation	5
[EN ESPAÑOL] Información importante de seguridad	3-4
Colocación de advertencias de seguridad en operación	5



Intertek

ITS Report No. 100017854



**INSTALLER:** Leave this manual with the appliance.  
**CONSUMER:** Retain this manual for future reference.  
**INSTALLATEUR :** Laissez cette notice avec l'appareil.  
**CONSOMMATEUR :** Conservez cette notice pour consultation ultérieure.

# ! WARNING / AVERTISSEMENT / AVISO

- HOT GLASS WILL CAUSE BURNS.
- DO NOT TOUCH GLASS UNTIL COOLED.
- NEVER ALLOW CHILDREN TO TOUCH GLASS.



- UNE SURFACE VITRÉE CHAUDE PEUT CAUSER DES BRÛLURES.
- LAISSER REFROIDIR LA SURFACE VITRÉE AVANT D'Y TOUCHER.
- NE PERMETTEZ JAMAIS À UN ENFANT DE TOUCHER LA SURFACE VITRÉE.

- EL VIDRIO CALIENTE CAUSARÁ QUEMADURAS.
- USTED DEBE NUNCA TOCAR EL VIDRIO CALIENTE.
- LOS NIÑOS DEBEN NUNCA TOCAR EL VIDRIO.

**WARNING:** If the information in these instructions is not followed exactly, a fire or explosion may result, causing property damage, personal injury, or death.

- Do not store or use gasoline or other flammable vapors and liquids in the vicinity of this or any other appliance.
- **WHAT TO DO IF YOU SMELL GAS:**
  - Do not try to light any appliance.
  - Do not touch any electrical switch; do not use any phone in your building.
  - Immediately call your gas supplier from a neighbor's phone. Follow the gas supplier's instructions.
  - If you cannot reach your gas supplier, call the fire department.
- Installation and service must be performed by a qualified installer, service agency or the gas supplier.

**AVERTISSEMENT :** Assurez-vous de bien suivre les instructions données dans cette notice pour réduire au minimum le risque d'incendie ou d'explosion ou pour éviter tout dommage matériel, toute blessure ou la mort.

- Ne pas entreposer ni utiliser d'essence ni d'autres vapeurs ou liquides inflammables dans le voisinage de cet appareil ou de tout autre appareil.
- **QUE FAIRE SI VOUS SENTEZ UNE ODEUR DE GAZ :**
  - Ne pas tenter d'allumer d'appareil.
  - Ne touchez à aucun interrupteur. Ne pas vous servir des téléphones se trouvant dans le bâtiment où vous trouvez.
  - Appelez immédiatement votre fournisseur de gaz depuis un voisin. Suivez les instructions du fournisseur.
  - Si vous ne pouvez rejoindre le fournisseur de gaz, appelez le service des incendies.
- L'installation et l'entretien doivent être assurés par un installateur ou un service d'entretien qualifié ou par le fournisseur de gaz.

Thank you for your purchase. We appreciate your business!  
 Please carefully read and follow all instructions in this manual.  
**Pay special attention to all warnings and safety information.**  
 Following these safety, care, and operation instructions will help ensure many years of dependable and enjoyable service from your fireplace.

**• FREE SAFETY GUARD OFFER •**

*The Lennox® SAFETY GUARD protects against severe burns and injuries by preventing direct contact with the front glass surface of your fireplace.*

To receive your FREE SAFETY GUARD, call 1-800-786-7976 or visit [www.lennox.com](http://www.lennox.com) (Lennox Hearth Products / Owner Resources)

**TABLE OF CONTENTS**

**Safety and Your Fireplace** ..... 2  
**Important Safety Information** ..... 4  
**Attaching the Safety-in-Operation Warnings** ..... 5  
 Warranty Information ..... 6  
 Appliance Installation, Service, and Maintenance Notices ..... 6  
 Appliance Operation Notices ..... 6  
 General Information ..... 7  
     BTU Input ..... 7  
     Gas Pressure Requirements ..... 7  
     Orifice Sizes ..... 7  
     Burn-In Period ..... 7  
 Operation/Care of Your Appliance ..... 8  
 Gas Controls / Control Compartment Access ..... 8  
     Appliance Controls ..... 9  
     Lighting the Appliance ..... 9  
     ON/OFF Control ..... 9  
     Adjusting Flame Height ..... 9  
 Controls for Optional Outside Combustion Air Kit ..... 9  
 Maintenance Instructions ..... 10  
 Removing and Installing the Glass Enclosure Panel ..... 11  
 Installing Volcanic Stone, Glowing Embers (Rockwool), and Logs ..... 12  
     SLBV-35 Log Placement ..... 13  
     SLBV-40 Log Placement ..... 14  
 Burner Air Shutter Adjustments:  
     Flame Appearance and Sooting ..... 15  
     Air Shutter Adjustment Guidelines ..... 15  
     Burner Air Shutter Adjustment Procedure ..... 16  
 Appliance Checkout:  
     Millivolt Appliance Checkout ..... 16  
     Electronic Appliance Checkout ..... 16  
 Spillage Test ..... 17  
     Manually-Reset Safety Limit Switch ..... 17  
 Ordering Replacement Parts ..... 18  
 Product Reference Information ..... 18  
 Unit Catalog Nos. / Shipping Wts. .... 18  
 Wiring Diagrams ..... 18  
 Accessory Components ..... 19  
 Lighting Instructions – Millivolt ..... 22  
 Lighting Instructions – Electronic ..... 24  
 Maintenance Schedule ..... 26  
 Troubleshooting Guide – Millivolt ..... 27  
 Troubleshooting Guide – Electronic ..... 28  
 Replacement Parts List ..... 29



# Safety and Your Fireplace

**All parts of your Lennox Hearth Products fireplace get EXTREMELY HOT!**

- To prevent severe burns and injuries, install a screen or physical barrier to prevent direct contact with the glass.

*To order a FREE Lennox® SAFETY GUARD for your fireplace, see details at left.*

- Follow the safety instructions below and be sure everyone in your household understands this burn hazard:

- **The surfaces on your fireplace get EXTREMELY HOT!**

- **The glass on the front of the fireplace reaches EXTREMELY HIGH temperatures and can cause severe burns if touched.**

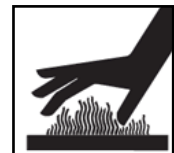

- **Keep children away from an operating fireplace. Closely supervise children in any room where a fireplace is operating to prevent contact with glass.**

- **Keep clothing, furniture, gasoline, and other flammable liquids away from the fireplace.**

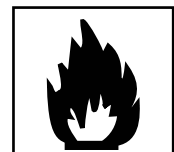

- **Even after the gas is turned off, fireplace surfaces remain extremely hot.**

- Be sure to attach the enclosed **Safety-in-Operation Warnings** where you turn on your fireplace, to help remind everyone of the dangers associated with high temperatures (see **Page 5**).

- Read **Important Safety Information** on **Page 4**.

[FRENCH]

## ***La sécurité et votre foyer***

**Toutes les parties de votre foyer Lennox Hearth Products deviennent EXTRÊMEMENT CHAUDES !**

- Afin d'éviter de vous brûler gravement ou de vous blesser, installez une grille ou une barrière physique pour empêcher tout contact direct avec la vitre.

***Pour commander un PANNEAU DE PROTECTION Lennox® GRATUIT pour votre foyer, consultez les détails dans la partie gauche.***

- Suivez les instructions de sécurité ci-dessous et veillez à ce que tous les membres de votre famille soient conscients du danger de brûlure encouru :
  - **Les surfaces de votre foyer deviennent EXTRÊMEMENT CHAUDES !**
  - **La vitre située à l'avant du foyer atteint des températures EXTRÊMEMENT ÉLEVÉES et peut causer de graves blessures en cas de contact.**
  - **Tenez les enfants à l'écart du foyer lorsqu'il fonctionne. Surveillez attentivement les enfants dans les pièces où un foyer est utilisé afin d'éviter qu'ils ne soient en contact avec la vitre.**
  - **Tenez tous les vêtements, les meubles, l'essence et tout autre liquide inflammable à l'écart du foyer.**
  - **Même après fermeture du gaz, les surfaces du foyer restent extrêmement chaudes.**
- Veillez à coller les **Étiquettes de mise en garde relatives à la sécurité d'utilisation** à l'endroit où vous utilisez le foyer, pour rappeler à tous les utilisateurs les dangers liés aux températures élevées (**voir Page 5**).
- Lisez la section **Informations importantes relatives à la sécurité, Page 4.**

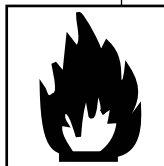

[SPANISH]

## ***Seguridad y su chimenea***

**¡Todas las partes de la chimenea Lennox Hearth Products se ponen MUY CALIENTES!**

- Instale una malla o barrera física para evitar el contacto directo con el vidrio y prevenir las quemaduras y lesiones graves.

***Ver los detalles a la izquierda para ordenar un Lennox® SAFETY GUARD GRATIS para su chimenea.***

- Siga las instrucciones de seguridad a continuación y asegúrese de que todos en su hogar sepan acerca de este peligro de quemadura:
  - **¡Las superficies de la chimenea se ponen MUY CALIENTES!**
  - **El vidrio delante de la chimenea alcanza temperaturas EXTREMADAMENTE ALTAS y puede causar quemaduras graves si se toca.**
  - **Mantenga a los niños alejados de la chimenea en funcionamiento. Supervise en forma cercana a los niños en cualquier cuarto donde haya una chimenea funcionando para impedir el contacto con el vidrio.**
  - **Mantenga la ropa, mobiliario, gasolina y otros líquidos inflamables alejados de la chimenea.**
  - **Aún después de haber apagado el gas, las superficies de la chimenea permanecen extremadamente calientes.**
- Asegúrese de colocar las **Etiquetas de advertencia de seguridad de operación** en el lugar donde enciende la chimenea, para que todos recuerden los peligros asociados con las altas temperaturas (**ver la página 5**).
- Lea la **Información importante** de seguridad en la **página 4.**

## Important Safety Information

- 1. WARNING: Do not operate appliance with the glass front removed, cracked or broken. Replacement of the glass should be done by a licensed or qualified service person .**
- 2. Do not use this appliance if any part has been under water. Immediately call a qualified service technician to inspect the appliance and to replace any part of the control system and any gas control which has been under water.**
- 3. Due to high temperatures, the appliance should be located out of traffic and away from furniture and draperies.**
- 4. Children and adults should be alerted to the hazards of high surface temperature and should stay away to avoid burns or clothing ignition.**
- 5. Clothing or other flammable material should not be placed on or near the appliance.**
- 6. Young children should be carefully supervised when they are in the same room as the appliance. Toddlers, young children, and others may be susceptible to accidental contact burns. A physical barrier is recommended if there are at-risk individuals in the house. To restrict access to a fireplace or stove, install an adjustable safety gate to keep toddlers, young children, and other at-risk individuals out of the room and away from hot surfaces.**
- 7. Any safety screen or guard removed for servicing an appliance must be replaced prior to operating the appliance.**
- 8. Installation and repair should be done by a qualified service person. The appliance should be inspected before use and at least annually by a professional service person. More frequent cleaning may be required due to excessive lint from carpeting, bedding material, et cetera. It is imperative that control compartments, burners, and circulating air passageways of the appliance be kept clean. See maintenance instructions on Page 10.**

## L'information de sûreté importante

- 1. AVERTISSEMENT. Ne pas utiliser l'appareil si le panneau frontal en verre n'est pas en place, est craqué ou brisé. Confiez le remplacement du panneau à un technicien agréé**
- 2. Ne pas utiliser cet appareil s'il a été plongé, même partiellement, dans l'eau. Appeler un technicien qualifié pour inspecter l'appareil et remplacer toute partie du système de commande et toute commande qui a été plongée dans l'eau.**
- 3. En raison des températures élevées, l'appareil devrait être installé dans un endroit où il y a peu de circulation et loin du mobilier et des tentures.**
- 4. Les enfants et les adultes devraient être informés des dangers que posent les températures de surface élevées et se tenir à distance afin d'éviter des brûlures ou que leurs vêtements ne s'enflamment.**
- 5. On ne devrait pas placer de vêtements ni d'autres matières inflammables sur l'appareil ni à proximité.**
- 6. Les jeunes enfants devraient être surveillés étroitement lorsqu'ils se trouvent dans la même pièce que l'appareil. Les tout petits, les jeunes enfants ou les adultes peuvent subir des brûlures s'ils viennent en contact avec la surface chaude. Il est recommandé d'installer une barrière physique si des personnes à risques habitent la maison. Pour empêcher l'accès à un foyer ou à un poêle, installez une barrière de sécurité ; cette mesure empêchera les tout petits, les jeunes enfants et toute autre personne à risque d'avoir accès à la pièce et aux surfaces chaudes.**
- 7. Tout écran ou protecteur retiré pour permettre l'entretien de l'appareil doit être remis en place avant de mettre l'appareil en marche.**
- 8. L'installation et la réparation devrait être confiées à un technicien qualifié. L'appareil devrait faire l'objet d'une inspection par un technicien professionnel avant d'être utilisé et au moins une fois l'an par la suite. Des nettoyages plus fréquents peuvent être nécessaires si les tapis, la literie, et cetera produisent une quantité importante de poussière. Il est essentiel que les compartiments abritant les commandes, les brûleurs et les conduits de circulation d'air de l'appareil soient tenus propres. Voyez les instructions d'entretien à la Page 10.**

[SPANISH]

## Información importante de seguridad

- 1. ADVERTENCIA: No opere el artefacto con el frente de vidrio quitado, agrietado o roto. Un técnico de servicio licenciado o capacitado debe reemplazar el vidrio.**
- 2. No use este artefacto si alguna de sus partes ha estado bajo agua. Llame de inmediato a un técnico de servicio calificado para que inspeccione el artefacto y reemplace cualquier parte del sistema de control y cualquier control de gas que haya estado bajo agua.**
- 3. Debido a las altas temperaturas, el artefacto debe situarse fuera de las áreas de tráfico y lejos del mobiliario y cortinas.**
- 4. Se debe alertar a los niños y adultos sobre los peligros de las altas temperaturas en la superficie y que se mantengan alejados para evitar quemaduras o ignición de la ropa.**
- 5. No debe colocarse ropa u otros materiales inflamables sobre y cerca del artefacto.**

- 6. Se debe supervisar de cerca a los niños cuando estén en el mismo cuarto que el artefacto. Los niños pequeños, los jóvenes y otras personas pueden ser susceptibles a quemaduras por contacto accidental. Se recomienda instalar una barrera física si hay personas en riesgo en la casa. Para restringir el acceso a una chimenea o estufa, instale una puerta de seguridad ajustable para mantener a los niños pequeños, jóvenes y otras personas en riesgo fuera del cuarto y lejos de las superficies calientes.**
- 7. Cualquier malla o resguardo de seguridad quitado para dar servicio a un artefacto, debe reinstalarse antes de operar el artefacto.**
- 8. Una persona de servicio competente debe realizar la instalación y reparación. Una persona de servicio profesional debe inspeccionar el artefacto antes de usar al menos una vez por año. Se puede requerir limpieza más frecuente debido a la pelusa excesiva del alfombrado, del material de cobijas, etc. Es imprescindible mantener limpios los compartimientos de control, los quemadores y los pasajes de circulación del aire del artefacto. Ver las instrucciones de mantenimiento en la página 10.**

## HOMEOWNER'S INSTRUCTIONS: ATTACHING "SAFETY-IN-OPERATION" WARNINGS

### ATTACHING "SAFETY-IN-OPERATION" WARNINGS

Your fireplace has been furnished with safety instruction labels that are to be affixed to the operation and control point of the fireplace. A safety instruction label should be affixed to the wall switch plate where the fireplace is turned on and off (See **Figure A**) and if used on the remote control handheld transmitter (**Figure B**). The warnings should already have been put in place when the fireplace initial set-up was completed. If they are not affixed at these spots, locate the multi-lingual adhesive labels provided with these instructions and proceed as follows:

1. Locate the wall switch that controls the fireplace (verify the switch operates the fireplace by turning it on and off). Clean the wall switch plate thoroughly to remove any dust and oils. Affix the label to the surface of the plate of the wall switch that controls the fireplace (**Figure A**). Choose the language primarily spoken in the home.
2. If a remote control is used to control the fireplace, locate the transmitter and clean it thoroughly to remove any dust and oils. Affix the label to the surface of handheld transmitter (**Figure B**). Choose the language primarily spoken in the home.
3. If you are unable to locate the labels, please call Lennox Hearth Products or your nearest Lennox Hearth Products dealer to receive additional safety instruction labels free of charge.

Cat. No. H8024 Replacement Label Kit

**LENNOX HEARTH PRODUCTS**  
1-800-9-LENNOX

*Note: English is red text on clear label. French and Spanish are white text on black label.*

### SAFETY LABEL DIAGRAMS



**Figure A**

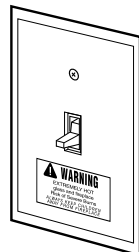

### APPOSITION DES MISES EN GARDE RELATIVES À LA SÉCURITÉ D'UTILISATION

Votre foyer a été livré avec des étiquettes de sécurité qui doivent être collées à côté des dispositifs de contrôle du foyer. Une étiquette de sécurité devrait être collée sur la plaque de l'interrupteur contrôlant l'allumage du foyer (*voir Figure A*) et, le cas échéant, sur le boîtier de la télécommande (*Figure B*). Les mises en garde auraient dû être collées au moment de l'installation initiale du foyer. Si ce n'est pas le cas, prenez les étiquettes adhésives multilingues fournies avec ces instructions et procédez comme suit:

1. Repérez l'interrupteur qui contrôle le foyer (vérifiez que l'interrupteur contrôle le fonctionnement du foyer en le faisant basculer de Marche à Arrêt, et vice-versa). Nettoyez soigneusement la plaque murale de l'interrupteur pour éliminer la poussière et les traces de graisse ou d'huile. Collez l'étiquette sur la surface de la plaque de l'interrupteur mural qui contrôle le foyer (**Figure A**). Choisissez la langue qui est principalement parlée dans la résidence du propriétaire.
2. Si une télécommande est utilisée pour contrôler le foyer, nettoyez la soigneusement pour éliminer la poussière et les traces de graisse ou d'huile. Collez l'étiquette sur le boîtier de la télécommande (**Figure B**). Choisissez la langue qui est principalement parlée dans la résidence du propriétaire.
3. Si vous ne trouvez pas les étiquettes, veuillez appeler Lennox Hearth Products ou votre distributeur Lennox Hearth Products local pour recevoir gratuitement des étiquettes supplémentaires.

Étiquettes de remplacement, n° cat. H8024

**LENNOX HEARTH PRODUCTS**  
1-800-9-LENNOX

*Remarque : Le texte anglais est rouge sur un support transparent. Le texte français et espagnol est blanc sur un support noir.*

### DIAGRAMMES DES ÉTIQUETTES DE SÉCURITÉ



**Figure B**

### COLOCACIÓN DE ADVERTENCIAS DE SEGURIDAD EN OPERACIÓN

Su chimenea incluye etiquetas de instrucciones de seguridad que deben colocarse en el punto de operación y control de la chimenea. Se debe colocar una etiqueta de instrucciones de seguridad en la placa del interruptor de pared desde el cual se enciende y se apaga la chimenea (*ver la Figura A*) y en el transmisor de control remoto (*Figura B*) si se usa. Las advertencias ya deben haberse colocado cuando se completó la instalación inicial de la chimenea. Si no están colocadas en estos lugares, encuentre las etiquetas adhesivas multilingües proporcionadas con estas instrucciones y prosiga de la siguiente manera:

1. Identifique el interruptor de pared que controla la chimenea (verifique que el interruptor opera la chimenea encendiéndola y apagándola). Limpie bien la placa del interruptor de pared para quitar el polvo y aceite. Pegue la etiqueta en la superficie de la placa del interruptor que controla la chimenea (**Figura A**). Seleccione el idioma que más se habla en la casa.
2. Si se usa un control remoto para controlar la chimenea, encuentre el transmisor y límpielo bien para quitar el polvo y aceite. Pegue la etiqueta en la superficie del transmisor (**Figura B**). Seleccione el idioma que más se habla en la casa.
3. Si no puede encontrar las etiquetas, sírvase llamar a Lennox Hearth Products o al distribuidor de Lennox Hearth Products más cercano para recibir etiquetas de instrucciones de seguridad adicionales gratuitas.

Juego de etiquetas de repuesto - N° de cat. H8024

**LENNOX HEARTH PRODUCTS**  
1-800-9-LENNOX

*Nota: La etiqueta en inglés es transparente con texto rojo. Las etiquetas en francés y español son negras con texto blanco.*

### DIAGRAMAS DE ETIQUETAS DE SEGURIDAD



NOTE: DIAGRAMS & ILLUSTRATIONS ARE NOT TO SCALE.

Download from Wwww.Somanuals.com. All Manuals Search And Download.

## Warranty Information

Your gas appliance is covered by a limited twenty-year warranty. You will find a copy of the warranty accompanying this manual. Please read the warranty to be familiar with its coverage.

Retain this manual. File it with your other documents for future reference.

**Failure to comply with the installation and operating instructions provided will result in an improperly installed and operating appliance, voiding its warranty.**

**Do not attempt to alter or modify the construction of the appliance or its components. Any modification or alteration may void the warranty, certification, and listings of this unit.**

## Appliance Installation, Service, and Maintenance Notices

**IMPORTANT: Improper installation, adjustment, alteration, service, or maintenance can cause injury or property damage. Refer to this manual. For assistance or additional information, consult a qualified installer, service agency or the gas supplier.**

**Only trim kit(s) supplied by the manufacturer shall be used in the installation of this appliance.**

**Draft relief openings must not be covered or blocked.**

**These appliances must not be connected to a chimney or flue serving a separate solid fuel burning appliance.**

**Any change to this appliance and/or its operating controls is dangerous. Improper installation or use of this appliance can cause serious injury or death from fire, burns, explosion or carbon monoxide poisoning.**

**CARBON MONOXIDE POISONING: Early signs of carbon monoxide poisoning are similar to the flu with headaches, dizziness and/or nausea. If you have these signs, obtain fresh air immediately. Turn off the gas supply to the appliance and have it serviced by a qualified professional, as it may not be operating correctly. Some people are more affected by carbon monoxide than others, including pregnant women, people with heart or lung disease or anemia, those under the influence of alcohol, and those at high altitudes.**

**Turn off gas and electrical power to the fireplace and allow it to cool before cleaning or servicing the appliance.**

## Appliance Operation Notices

**Do not operate appliance with the glass front removed, cracked, or broken.**

**These fireplaces are vented gas appliances. Do not burn wood or other material in these appliances.**

**This appliance is only for use with the type of gas indicated on rating plate. This appliance is not convertible for use with other gases, unless a certified kit is used.**

**These appliances are designed to operate on natural gas or propane gas only. The use of other fuels or combinations of fuels will degrade the performance of this system and may be dangerous.**

**Provide adequate clearances around air openings and adequate accessibility clearance for service and proper operation. Never obstruct the front openings of the appliance.**

**Do not use this appliance if any part has been under water. Immediately call a qualified service technician to inspect the appliance and to replace any part of the control system and any gas control that has been under water.**

**These fireplaces are designed as supplemental heaters. Therefore, it is advisable to have an alternate primary heat source when installed in a dwelling.**

### **WARNING**

**B-Vent appliances are not designed to operate in negatively pressured environments (pressure within the home is less than pressures outside). Significant negatively pressured environments caused by weather, home design, or other devices may impact the operation of these appliances. Negative pressures may result in poor flame appearance, sooting, damage to property and/or severe personal injury. Do not operate these appliances in negatively pressured environments.**

## GENERAL INFORMATION

The fireplace models covered in this manual are B-vented decorative gas appliances designed for residential application.

**Millivolt** appliances have a millivolt gas control valve with piezo ignition system.

**Electronic** appliances have a battery backed-up electronic intermittent pilot system. No external electrical power is required to operate these appliances; however, 120 VAC is recommended (see *Installation Instructions*).

These appliances comply with National Safety Standards and are tested and listed by ITS (Report No. 100017854) to ANSI Z21.50 (in Canada, CSA-2.22) and to CAN/CGA-2.17-M91 in both USA and Canada (latest editions at time of manual publication) as vented gas fireplaces.

Installation must conform to local codes, or, in the absence of local codes, with the National Fuel Gas Code, ANSI Z223.1/NFPA 54 (latest edition), or the Natural Gas and Propane Installation Code, CAN/CSA B149.1 (latest edition).

The appliance, when installed, must be electrically grounded and wired in accordance with local codes or, in the absence of local codes, with the USA National Electrical Code, ANSI/NFPA 70 (latest edition) or, in Canada, the Canadian Electrical Code, CSA C22.1 (latest edition).

### BTU Input

Millivolt and electronic models come standard with a manually-modulated gas valve; flame appearance and heat output can be controlled at the gas valve. The BTU inputs for these appliances are shown in *Table 1*.

Input (BTU/HR) Manually Modulated Gas Valves (all models)		
Models	Input Rate (BTU / HR)	
	Nat. Gas	Prop. Gas
SLBV-35	17,000 high 13,000 low	17,000 high 14,000 low
SLBV-40	22,000 high 17,000 low	20,000 high 15,500 low

*Table 1*

### Gas Pressure Requirements (All Models)

Gas pressure requirements are listed in *Tables 2 and 3*.

Test gauge connections are provided on the front of the gas control valve, identified **IN** for the inlet and **OUT** for the manifold side (see *Figures 3 and 4*).

Propane tanks are at pressures that will cause damage to valve components. Verify that the tanks have step-down regulators to reduce the pressure to safe levels.

### Gas Pressure Requirements

(continued)

Inlet Gas Supply Pressure (all models)		
Fuel #	Minimum	Maximum
Natural Gas	4.5" WC (1.12 kPa)	10.5" WC (2.61 kPa)
Propane	11.0" WC (2.74 kPa)	13.0" WC (3.23 kPa)

*Table 2*

Manifold Gas Supply Pressure (all models)		
Fuel #	Low	High
Natural Gas	(Lo) 2.2" WC (0.55 kPa)	(Hi) 3.5" WC (0.87 kPa)
Propane	(Lo) 6.3" WC (1.57 kPa)	(Hi) 10.0" WC (2.49 kPa)

*Table 3*

These appliances must be isolated from the gas supply piping system (by closing their individual manual shut-off valve) during any pressure testing of the gas supply piping system at test pressures equal to or less than 1/2 psig (3.5 kPa).

These appliances and their individual shut-off valves must be disconnected from the gas supply piping system during any pressure testing of that system at pressures greater than 1/2 psig (3.5 kPa).

### Burn-in Period

During the first few fires in this appliance, there will be some odor due to the curing of the paint and burning off of lubricants used in the manufacturing process. Depending on your use, the burn-in period may take a few hours or a few days.

**KEEP YOUR HOUSE WELL VENTILATED DURING THE BURN-IN PROCESS. THE ODOR AND HAZE EMITTED DURING THE BURN-IN PROCESS CAN BE QUITE NOTICEABLE AND MAY SET OFF A SMOKE DETECTOR.**

### Orifice Sizes

(Sea Level to High Altitude – All Models)

These appliances are tested and approved for installation at elevations of 0–4500 feet (0–1372 meters) above sea level using the standard burner orifice sizes (marked with an asterisk (\*) in *Table 4, below*).

For elevations above 4500 feet, contact your gas supplier or a qualified service technician.

### Deration

At higher elevations, the amount of BTU fuel value delivered must be reduced by either:

- using gas that has been derated by the gas company,
- changing the burner orifice to a smaller size as regulated by the local authorities having jurisdiction and by the (USA) National Fuel Gas Code NFPA 54/ANSI Z223.1 - latest edition or, in Canada, the CAN/CSA-B149.1 codes - latest edition.

Install the appliance according to the regulations of the local authorities having jurisdiction and, in the USA, the National Fuel Gas Code NFPA 54 / ANSI Z223.1 - latest edition or, in Canada, the CAN/CSA-B149.1 - latest edition.

**NOTE: Flame appearance will diminish 4% per thousand feet of altitude.**

Burner Orifice Sizes Elevation 0-4500 feet ( 0-1372 meters)		
Model Series	Nat. Gas drill size (inches)	Propane drill size (inches)
SLBV-35	#48 (0.076")* H1236•	#56 (0.046")* 62L37•
SLBV-40	#43 (0.089")* 99K75•	#55 (0.052")* 19L52•

*Table 4*      \* Standard size installed at factory.  
• Part /Catalog Number.

### IMPORTANT NOTE!

A white film may develop on the glass enclosure panel during the first few fires as part of the burn-in process.

**The first few times you use the fireplace, clean the glass after each use (AFTER THE GLASS HAS COMPLETELY COOLED); otherwise, the white film will bake onto the glass and become difficult to remove.**

See "Clean Glass Enclosure Panel" on *Page 10*.



## OPERATION AND CARE OF YOUR APPLIANCE

### WARNING

Young children should be carefully supervised when they are in the same room as the appliance. Toddlers, young children and others may be susceptible to accidental contact burns. A physical barrier is recommended if there are at risk individuals in the house. To restrict access to a fireplace or stove, install an adjustable safety gate to keep toddlers, young children and other at risk individuals out of the room and away from hot surfaces.

### AVERTISSEMENT

Les jeunes enfants devraient être surveillés étroitement lorsqu'ils se trouvent dans la même pièce que l'appareil. Les tout petits, les jeunes enfants ou les adultes peuvent subir des brûlures s'ils viennent en contact avec la surface chaude. Il est recommandé d'installer une barrière physique si des personnes à risques habitent la maison. Pour empêcher l'accès à un foyer ou à un poêle, installez une barrière de sécurité; cette mesure empêchera les tout petits, les jeunes enfants et toute autre personne à risque d'avoir accès à la pièce et aux surfaces chaudes.

Note: Millivolt system shown. Electronic system controls are similarly located.

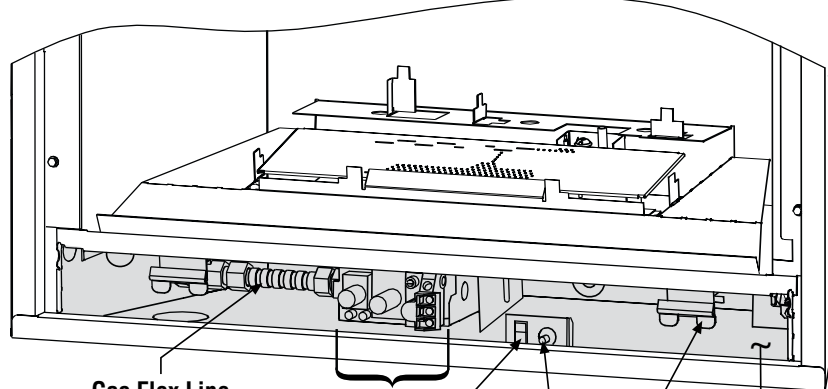

**Gas Flex Line**  
(Gas Shut-Off Valve is behind door latch; see DETAIL, below)

**Gas Control Valve**

**Piezo**  
(Millivolt units only)

**Spring Door Latch**  
(one of two)

DETAIL: Gas Shut-Off Valve in ON position (gas line OPEN)

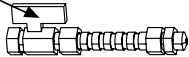

To shut OFF gas: Turn valve handle perpendicular (cross-wise) to gas line.

Optional Unit-Mounted ON/OFF Switch

Lower Control Compartment (shaded area)

Figure 1

## GAS CONTROLS / CONTROL COMPARTMENT ACCESS

Fireplace gas controls are located in the lower control compartment under the firebox (see **Figure 1**). Remove the control compartment door to access the controls.

### To remove the control compartment door:

Gently pull upward and forward on the door panel; then slide the panel, first to one side and then to the other, until the door tabs clear both holes (see **Figure 2**).

### To reinstall the control compartment door:

Insert one of the door panel side tabs into its corresponding hole in the control compartment opening (see **Figure 2**); then insert the other side tab. Lift upward on the door panel; then gently push the top edge forward and down into the grooves in the brackets until it locks into place.

(Continued on next Page)

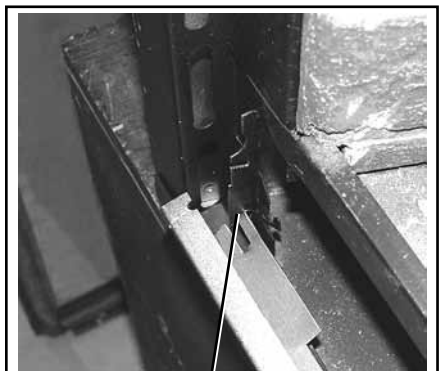

Control Compartment Door Tab

Figure 2



## Appliance Controls

Operation of millivolt and electronic gas control systems differs. Before lighting and operating your appliance, determine whether you have a millivolt or electronic appliance, and then familiarize yourself with the location of the **Gas Control Valve** and **Gas Shut-Off Valve** on your specific appliance.

- For general control location, see **Figure 1**.
- For **MILLIVOLT** appliances, see **Figure 3** for a detailed illustration of the **SIT Millivolt Gas Control Valve**.
- For **ELECTRONIC** appliances, see **Figure 4** for a detailed illustration of the **Dexen Electronic Gas Control Valve**.

## Lighting the Appliance

- Detailed **MILLIVOLT** appliance lighting instructions are on **Pages 22 and 23** and **also on the label attached to the gas control valve**.
- Detailed **ELECTRONIC** appliance lighting instructions are on **Pages 24 and 25** and **also on the label attached to the gas control valve**. Also see "Lighting an Electronic Appliance During a Power Outage," below.

### LIGHTING AN ELECTRONIC APPLIANCE DURING A POWER OUTAGE

1. Install (2) "D" batteries in battery holder.
2. Light the appliance according to the instructions on **Page 24**.
3. Operate the appliance normally.
4. After power is restored, remove the batteries.

**Note:** To prevent batteries from draining prematurely, do NOT install batteries until needed (e.g., during a power outage or if operating the appliance solely with batteries).

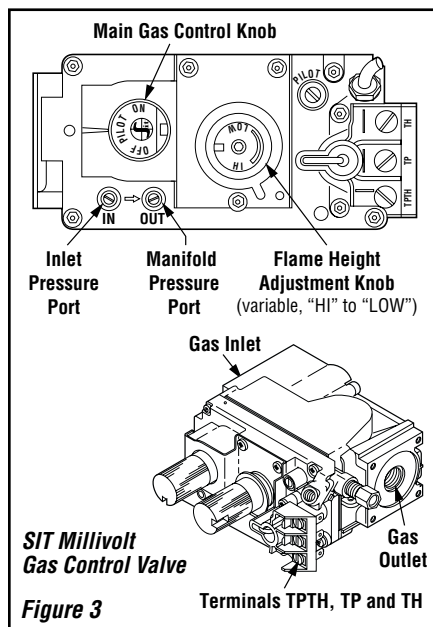

## ON/OFF Control

Available ON/OFF control options for both **MILLIVOLT** and **ELECTRONIC** models include a unit-mounted ON/OFF switch (shown in **Figure 1**), a wall switch, or a remote control system. See the "Accessory Components" section in this manual for details.

**Note:** To prevent excessive resistance in burner circuit (which can cause burner operation problems), wire only one burner control switch to the valve.

## Adjusting Flame Height

After lighting the appliance, rotate the **Flame Height Adjustment Knob** to adjust the flame in a variable range from "LOW" to "HI" (manual adjustment only; no remote options).

- For **MILLIVOLT** appliances, see **Figure 3**.
- For **ELECTRONIC** appliances, see **Figure 4**.

## CONTROLS FOR OPTIONAL OUTSIDE COMBUSTION AIR KIT

An optional outside combustion air system may be used with these appliances to provide supplemental combustion air from outside the home during appliance operation. If used, the outside combustion air kit must be installed before the fireplace is framed and enclosed in the finished wall.

The **Outside Air Control Lever** for this type of system is standard on all models (see **Figure 5**); however, do NOT operate the **Outside Air Control Lever** if the complete system is NOT installed.

When a complete outside supplemental combustion air system is installed, the installer will remove the securing screw from the control lever on the LEFT side of the fireplace opening (see **Figure 5**).

If the securing screw has NOT been removed, and you have reason to believe your fireplace has a **complete** outside supplemental combustion air system, contact your dealer or distributor to have your appliance inspected.

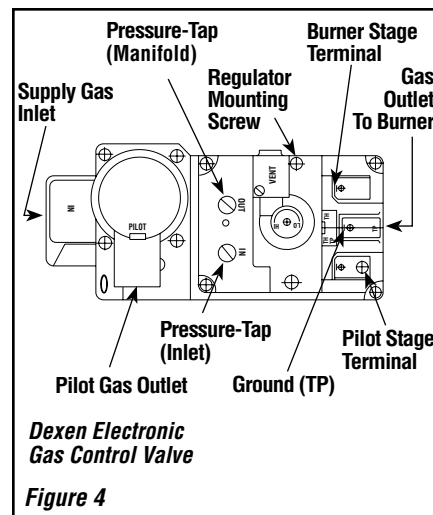

**IMPORTANT:** Do NOT assume your fireplace has a complete supplemental combustion air system, and do NOT operate the **Outside Air Control Lever** unless you have verified with your dealer or distributor that a **complete system is in place**.

The hand-operated outside air control lever is located on the lower LEFT side of the fireplace opening. See **Figure 5**.

To open the outside air shutter, open the bottom control access panel, reach into the control compartment, and pull the outside air control lever all the way out. The outside air shutter should be fully open when the fireplace is in use and completely closed when the fireplace is not being used. Closing it when not in use will greatly reduce the amount of outside cold air entering the dwelling through the fireplace.

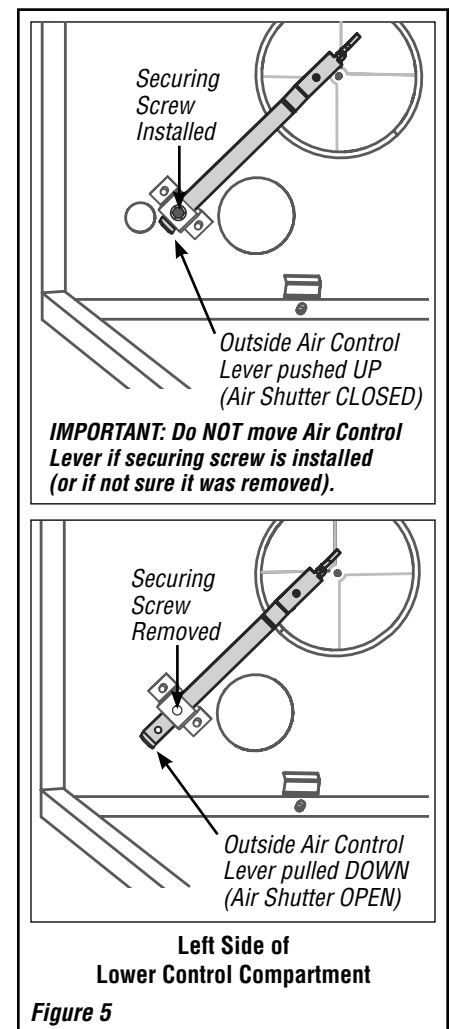

**WARNING**  
Do not operate the shutoff lever unless a complete outside combustion air system has been installed with your appliance.

NOTE: DIAGRAMS & ILLUSTRATIONS ARE NOT TO SCALE.

## MAINTENANCE INSTRUCTIONS

(See *Maintenance Schedule, Page 26*)

Refer to the maintenance schedule for maintenance tasks, procedures, frequency, and by whom they should be performed. Always verify proper operation of the appliance after servicing.

### WARNING

**Turn off gas and electrical power to the fireplace and allow it to cool before cleaning or servicing the appliance.**

**CAUTION: Wear gloves and safety glasses for protection while performing required maintenance.**

**Verify proper operation after servicing.**

*S'assurer que l'appareil fonctionne adéquatement une fois l'entretien terminé.*

**Always turn off gas to the pilot (millivolt appliances) before cleaning.**

**Before relighting the fireplace, refer to the lighting instructions in this manual. Instructions are also found on pull-out panels located below the glass enclosure panel, in the appliance control compartment.**

### **Inspect Venting System**

The appliance and venting system should be thoroughly inspected before initial use and at least annually by a qualified service technician (inspection should include ensuring that exhaust or intake passages are unobstructed and vent components are properly assembled and not damaged). **Homeowner must contact a qualified service technician at once if any abnormal condition is observed.**

If the venting system is disassembled for any reason, a qualified service technician should follow vent installation instructions for proper reassembly and proper sealing of the venting system components. However, more frequent periodic inspections and cleanings should be performed by the homeowner.

### **Inspect Glass Gasket**

Visually inspect the gasket on the backside of the glass enclosure panels. The gasket surface must be clean, free of irregularities and seated firmly.

### **Clean Glass Enclosure Panel**

(Refer to "Removing and Installing the Glass Enclosure Panel" on **Page 11**).

**Note:** *Clean glass after first two weeks of operation (after burn-in period is over) and then only when necessary and ONLY WHEN THE APPLIANCE IS COOL. Wipe surface with clean, dampened, soft cloth. Follow with dry, soft towel as desired. Take care not to scratch the glass surface.*

**IMPORTANT: Do not use abrasive cleaners on glass. Never clean the glass when it is hot.**

Clean the glass periodically, to remove any buildup caused by the following:

- *Filmy coating (during initial use after installation).* Initial curing of the high temperature paint and burning off of lubricants used in the manufacturing process may result in a filmy coating on the glass.
- *Dusty or dirty buildup.* It is normal for condensation and fog to form on the inside of the glass when first starting the appliance. This condensation and fog will usually disappear within a few minutes; however, over time the moisture can cause lint, dust, and other airborne particles to cling to the glass surface.
- *White coating.* A white coating may form on the glass as a result of impurities and minerals in the fuel.

It is recommended that the glass be cleaned two or three times during each heating season, depending on the circumstances. The following cleaning solutions are approved for use to clean the glass:

- Non-ammonia based household cleaner
- 50% white vinegar and 50% water
- Gas fireplace/stove glass cleaner

### **Clean Control Compartment**

Keep control compartment clean by vacuuming or brushing at least twice a year. More frequent cleaning may be required due to excessive lint from carpeting, bedding materials, etc. It is important that control compartments, burners and circulating air passageways of the appliance be kept clean.

### **Clean Logs and Burner**

Carefully remove the logs.

**Note:** *Use care when handling the logs, as they become quite fragile after curing.*

Vacuum out any foreign matter (lint, carbon, etc.) on the burner. Ensure the burner ports are "open." Remove any carbon deposits from the under side of the logs using a vacuum cleaner, or a soft bristled brush (i.e. paint brush).

**Note:** *Improper positioning of logs can create carbon buildup and will alter the performance of the appliance.*

### **Order Replacement Logs**

If the logs become damaged and need to be replaced, use only the proper replacement logs from the manufacturer (see **Pages 13 and 14** for ordering information).

### **Reinstall Embers and Logs**

Carefully follow placement instructions on **Pages 12–14**. All logs should fit onto corresponding pins and/or log stoppers. This will ensure a proper flame and safe combustion.

### **Inspect Wiring**

Refer to wiring diagrams on **Pages 18 and 19**.

**CAUTION: Label all wires prior to disconnection when servicing controls. Wiring errors can cause improper and dangerous operation. Verify proper operation after servicing.**

**ATTENTION: Au moment de l'entretien des commandes, étiquetez tous les fils avant de les débrancher. Des erreurs de câblage peuvent entraîner un fonctionnement inadéquat et dangereux.**

Inspect and clean all wire connections. Ensure that there is no melting or damage. Inspection should include:

- Terminals at the Valve
- Optional Control Switch (Wall ON/OFF Switch, Unit-Mounted ON/OFF Switch, or Remote ON/OFF Control System)

### **Inspect Burner Flame Appearance**

Ensure that the burner flame appearance resembles the flame shown in **Figures 11 and 12** and as described in "Flame Appearance and Sooting" on **Page q5**. The Homeowner must contact a qualified service technician at once if any abnormal condition is observed.

### **Small Area Paint Touch-up**

If the surface becomes stained or marred, it may be lightly sanded and touched-up with spray paint available from your local authorized Lennox Hearth Products dealer.

**NOTE:**

- **Only use factory-supplied paint for touch-ups.**
- **Never attempt to paint a hot fireplace.**

## REMOVING AND INSTALLING THE GLASS ENCLOSURE PANEL

### ⚠ WARNING

- Do not attempt to substitute the materials used on this door or replace cracked or broken glass.
- Handle this glass with extreme care! Glass is susceptible to damage; do NOT scratch or handle roughly while reinstalling the glass door frame.
- The glass door(s) of this appliance must only be replaced as a complete unit as provided by the manufacturer. Do not attempt to replace broken, cracked, or chipped glass separately.
- Do not attempt to touch the front enclosure glass with your hands while the fireplace is in use.

### ⚠ WARNING

Do not operate appliance with the glass front removed, cracked or broken.

### ⚠ AVERTISSEMENT

Ne pas utiliser l'appareil si le panneau frontal en verre n'est pas en place, est craqué ou brisé.

### ⚠ WARNING

Any safety screen or guard removed for servicing the appliance must be replaced prior to operating the appliance.

### ⚠ AVERTISSEMENT

Tout écran ou protecteur retiré pour permettre l'entretien de l'appareil doit être remis en place avant de mettre l'appareil en marche.

Only doors certified with the appliance shall be used.

*Seules des portes certifiées pour cet appareil doivent être utilisées.*

**CAUTION: DO NOT** abuse glass enclosure panel by striking or slamming shut.

This appliance is designed to operate only when the glass enclosure panel is installed. Do NOT remove the glass enclosure panel unless necessary (e.g., to gain access to components within the firebox or to clean the glass).

### Removing the Glass Enclosure Panel

1. Refer to **Figure 6**. To access the spring latches securing the front glass enclosure panel, open the lower control compartment door by lifting and pulling the bottom panel forward.
2. Pull the spring latches forward and down to release them from the lower door channel.
3. Pull the bottom of the glass enclosure panel out a few inches, and grasp it on the right and left sides. Gently lift to release the panel from its upper channel, and then pull the enclosure panel forward to remove it.
4. Visually inspect the gasket on the backside of the enclosure panel frame. The gasket surface must be clean, free of irregularities, and firmly seated.

### Installing the Glass Enclosure Panel

1. Refer to **Figure 6**. Position the glass enclosure panel in front of the firebox opening, with the bottom of the enclosure panel held away from the fireplace. Hook the top flange of the enclosure panel frame over the top of the firebox frame.
2. Gently move the bottom of the enclosure panel frame toward the fireplace, ensuring that the gasket seats evenly. Fasten the two latches under the firebox floor to the vee-flange on the enclosure panel. Close both latches securely.

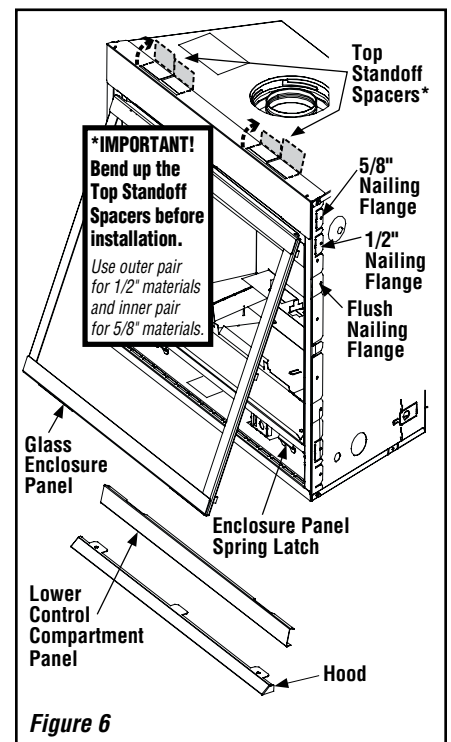
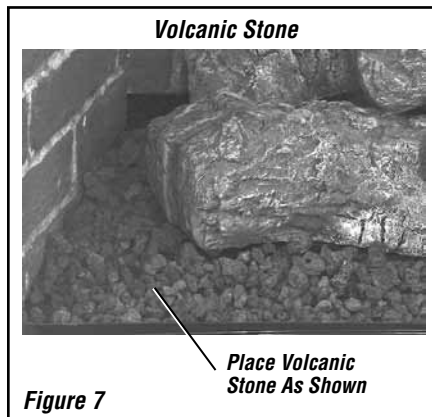

Figure 6

## INSTALLING VOLCANIC STONE, GLOWING EMBERS (ROCKWOOL), AND LOGS

**NOTE:** Turn OFF all electricity to the fireplace before installing volcanic stone, glowing embers, or logs.

1. Remove the front glass enclosure panel (see "Removing and Installing the Glass Enclosure Panel," on previous Page).
2. Install ceramic bricked panel liners.
3. Install decorative volcanic stone. Refer to **Figure 7**. Sprinkle the decorative volcanic stone in a pleasing pattern directly on the fire-box bottom, along the slope and to the back, at the right and left sides of the burner.



4. Place the glowing ember material (rockwool).

**Note:** The bag of Glowing Embers contains enough rockwool for several applications; therefore, do not use the entire bag at one time. For best glowing effect, replace the ember material annually.

Refer to **Figure 8**. Separate the glowing ember material into pieces about the size of a quarter. Keep the pieces fluffed up, not matted. Distribute the pieces over the surface of the burner, as shown in **Figures 9 and 10**. Do not use more than is necessary. Position the embers on the small holes of the ember bed area.

**Note:** Make sure the glowing ember material does NOT cover the main burner slots.

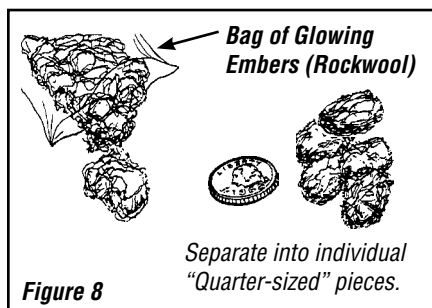

### 5. Install the Logs.

The logs have locating notches or slots to help ensure that they are properly positioned. The top logs that rest on lower logs, do so over notches, indents or nubs. Proper log placement is critical to prevent sooting. Logs should be placed in the gaps between the flame peaks and should be positioned so they do not impinge the flames. Follow the log placement instructions exactly.

#### SLBV-35

Carefully position the ceramic fiber logs over the burner in the order shown in **Figure 9** and per the following instructions:

1. Place the left front log (1) as shown. Position it on the two left front log brackets.
2. Place the right front log (2) as shown. Position it on the two right front log brackets.
3. Place the left rear log (3) as shown. Position it on the upper and lower left rear log brackets.
4. Place the right rear log (4) as shown. Position it on the right rear log bracket. Note that the hole on the bottom of the right rear log rests over the "nub" on the right front log.

#### SLBV-40

Carefully position the ceramic fiber logs over the burner in the order shown in **Figure 10** and per the following instructions:

1. Place the ember chunk (1) over the tab on the rear log support as shown.
2. Place the left front log (2) as shown. Position it on the two left front log brackets.
3. Place the right front log (3) as shown. Position it on the two right front log brackets.
4. Place the left rear log (4) as shown. Position it on the left rear log bracket.
5. Place the right rear log (5) as shown. Position it on the right rear log bracket. Note that the hole on the bottom of the right rear log rests over the "Nub" on the right front log.

## ⚠ WARNING

- **DO NOT attempt to install the logs until the appliance installation has been completed, the gas line connected and tested for leaks and the initial burner operation has been checked out.**
- **The size and position of the log set was engineered to give the appliance a safe, reliable and attractive flame pattern. Any attempt to use a different log set in the fireplace will void the warranty and will result in incomplete combustion, sooting, and poor flame quality.**
- **Logs get very hot and will remain hot up to one hour after gas supply is turned off. Handle only when logs are cool. Turn off all electricity to the appliance before you install grate, volcanic stone, embers, and logs.**
- **This appliance is not designed to burn wood. Any attempt to do so could cause irreparable damage to the appliance and prove hazardous to your safety.**
- **If logs are not installed according to the log installation instructions, flame impingement and improper combustion could occur and result in soot and/or excessive production of carbon monoxide (CO), a colorless, odorless, toxic gas.**

NOTE: DIAGRAMS & ILLUSTRATIONS ARE NOT TO SCALE.

### SLBV-35 LOG PLACEMENT INSTRUCTIONS

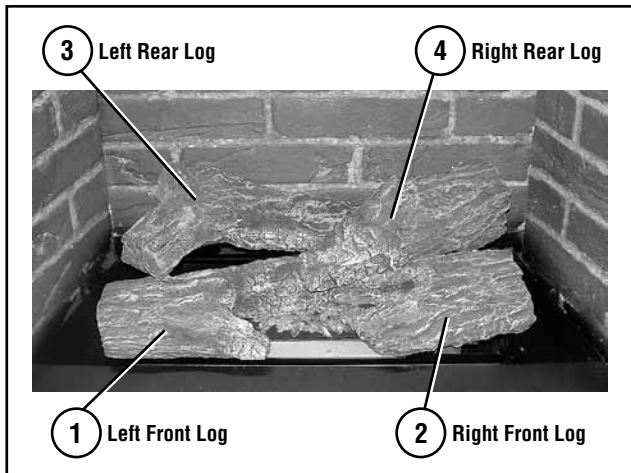

**Note:**

- Ceramic fiber logs are **FRAGILE!** Handle carefully to prevent breakage.
- Install volcanic stone and glowing embers **BEFORE** installing logs.
- To prevent sooting, make sure logs do not cover any burner openings.

SLBV Firebox Accessories/Parts		
Cat. No.	Model No.	Description
H7244	—	SLBV-35 Log Set Assembly
88L53	FGE	Bag of Glowing Embers (Rockwool)
80L42	FDVS	Bag of Decorative Volcanic Stone

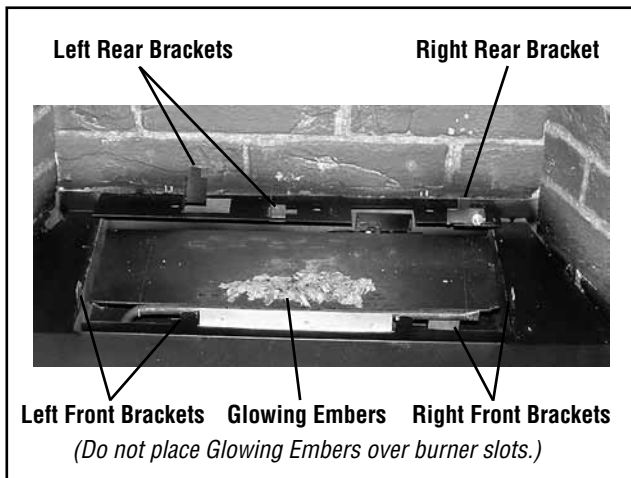

Step 1

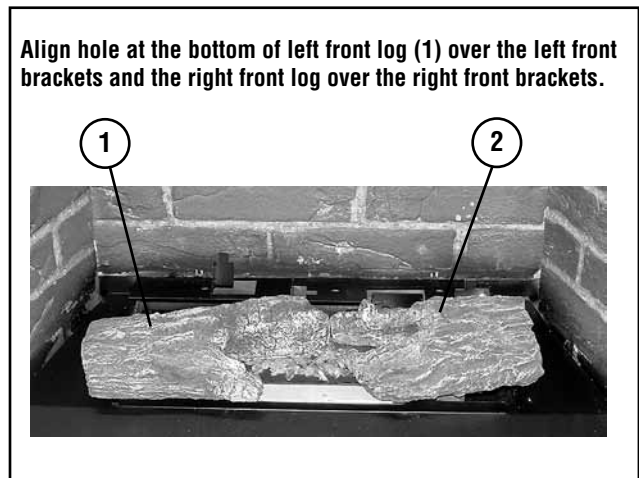

Step 2

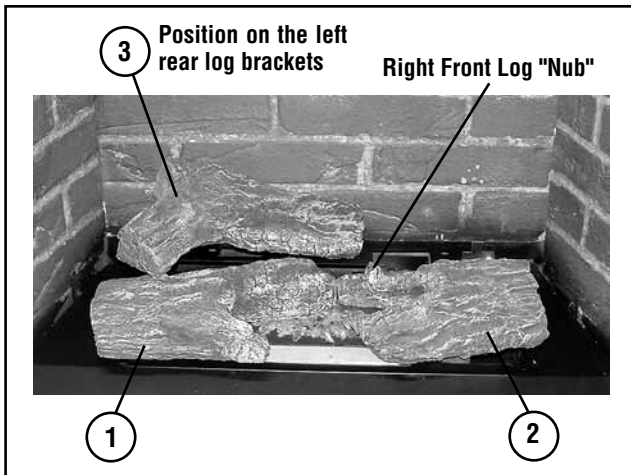

Step 3

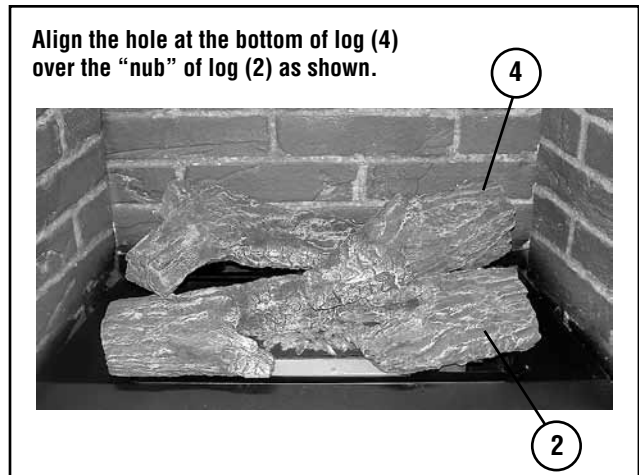

Step 4

Figure 9



### SLBV-40 LOG PLACEMENT INSTRUCTIONS

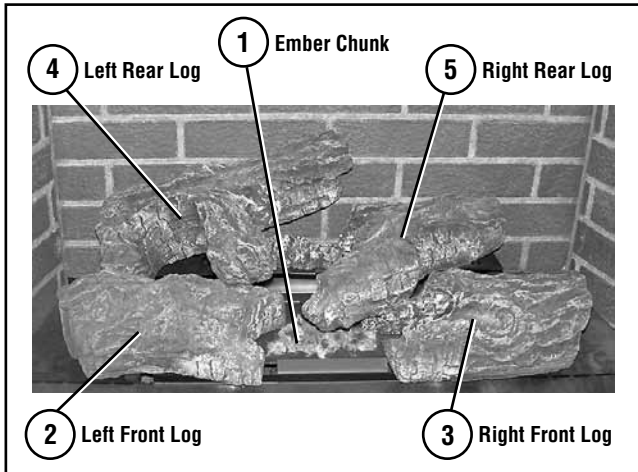

**Note:**

- Ceramic fiber logs are **FRAGILE!** Handle carefully to prevent breakage.
- Install volcanic stone and glowing embers **BEFORE** installing logs.
- To prevent sooting, make sure logs do **not** cover any burner openings.

SLBV Firebox Accessories/Parts		
Cat. No.	Model No.	Description
H7245	—	SLBV-40 Log Set Assembly
88L53	FGE	Bag of Glowing Embers (Rockwool)
80L42	FDVS	Bag of Decorative Volcanic Stone

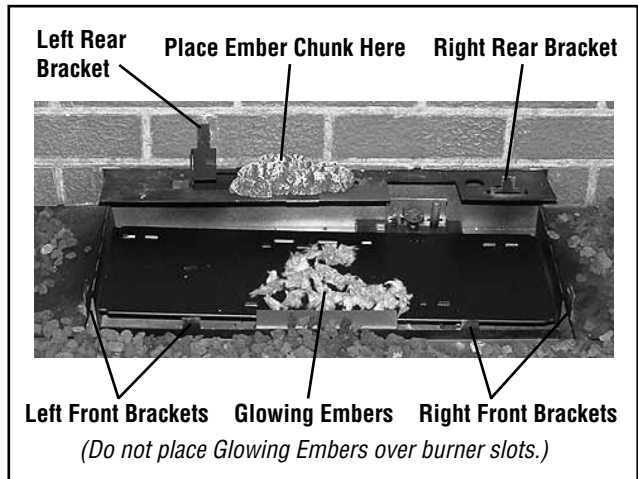

Step 1

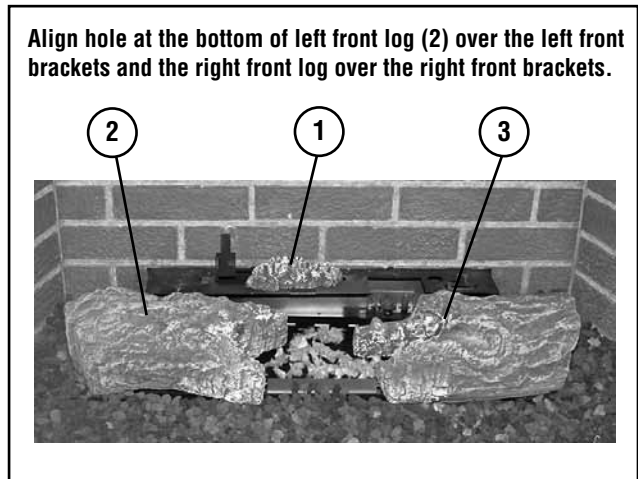

Step 2

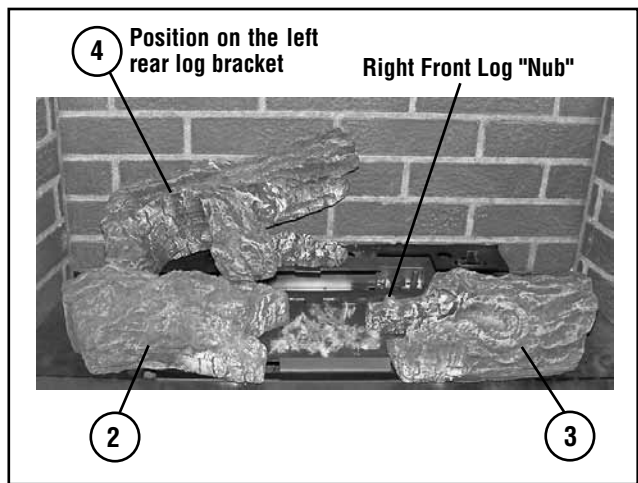

Step 3

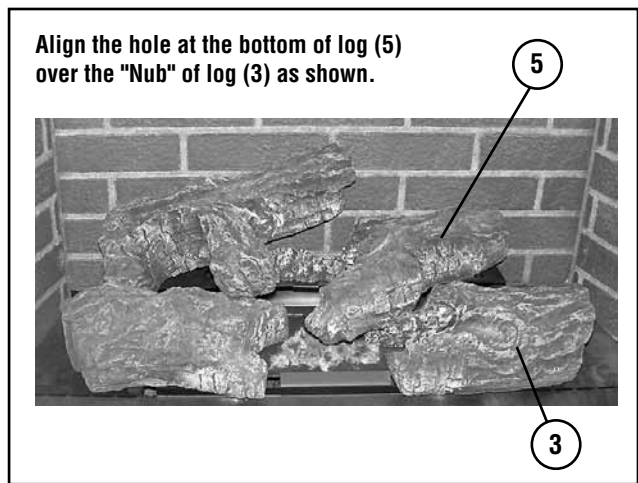

Step 4

Figure 10

## BURNER AIR SHUTTER ADJUSTMENTS

(QUALIFIED TECHNICIANS ONLY)

### Flame Appearance and Sooting

Proper flame appearance is a flame which is blue at the base and becomes yellowish-orange in the body of the flame. When the appliance is first lit, the entire flame may be blue and will gradually turn yellowish-orange during the first 15 minutes of operation. After 15 minutes of operation, if the flame is blue, or if the flame is orange with evidence of sooting (black tip), the air shutter opening may need to be adjusted.

If the air shutter opening is closed too far, sooting may develop. Sooting is indicated by black puffs developing at the tips of very long orange flames. Sooting results in black deposits forming on the logs, appliance inside surfaces and on exterior surfaces adjacent to the vent termination.

Sooting is caused by incomplete combustion in the flames and lack of combustion air entering the air shutter opening. To achieve a warm yellowish-orange flame with an orange body that does not soot, the shutter opening must be adjusted between these two extremes.

### Air Shutter Adjustment Guidelines

- If there is smoke or soot present, first check the log set positioning to ensure that the flames are not impinging on any of the logs. If the log set is properly positioned and a sooting condition still exists, then the air shutter opening should be increased.
- The more offsets in the vent system, the larger the air shutter opening will need to be.
- An appliance operated with the air shutter opened too far, may have flames that appear blue and transparent. These weak, blue and transparent flames are termed anemic.
- Propane models may exhibit flames which candle or appear stringy. If this is present and persists, adjust the air shutter to a more open position, then operate the appliance for a few more minutes to ensure that the flame normalizes and the flames do not appear sooty.

The following chart is provided to aid you in achieving the correct air shutter adjustment for your installation.

Air Shutter Adjustment Guidelines:		
Amount of Primary Air	Flame Color	Air Shutter Adjustment
If air shutter is closed too far →	Flame will be orange →	Air shutter gap should be increased
If air shutter is open too far →	Flame will be blue →	Air shutter gap should be decreased



Figure 11: Burner Flame Appearance Model SLBV-35



Figure 12: Burner Flame Appearance Model SLBV-40



**Burner Air Shutter Adjustment Procedure**

**⚠ WARNING**

- Air shutter adjustment should only be performed by a qualified professional service technician.
- Ensure front glass panel are in place and sealed during adjustment.

**⚠ CAUTION**

- Soot will be produced if the air shutter is closed too much. Any damage due to carboning resulting from improperly setting the air shutter is not covered under the warranty.
- The air shutter door and nearby appliance surfaces are hot. Exercise caution to avoid injury while adjusting flame appearance.

1. Locate adjustment rod and adjust air shutter to the standard setting as shown in **Figure 13** (adjustment rod is located in the lower control compartment).

*Note: Move the adjustment rod DOWN to decrease air and UP to increase air.*

2. Light appliance (follow lighting procedure on lighting label in control compartment or see the lighting instructions on **Pages 22 and 22** in this manual).

3. Allow the burner to operate for at least 15 minutes while observing the flame continuously to ensure that the proper flame appearance has been achieved (see **Figures 11 and 12 on previous Page**). If the following conditions are present, adjust accordingly.

- If flame appears weak or sooty, adjust the air shutter, incrementally, to a more open position until the proper flame appearance is achieved.
- If flame stays lowered blue, adjust the air shutter, incrementally, to a more closed position until the proper flame appearance is achieved.

4. Leave the control knob (off/pilot/on) in the ON position and the burner OFF/ON switch OFF (and remote switches, if applicable).

5. When satisfied that the burner flame appearance is normal, close the lower control compartment door (see **Figures 11 and 12 on previous Page**).

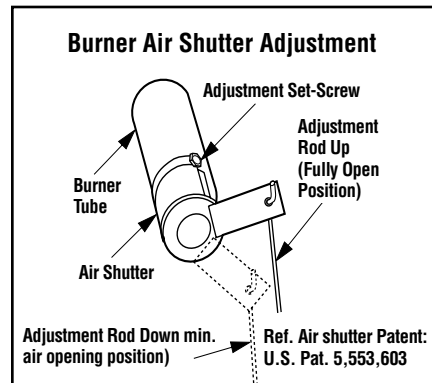

Main Burner Factory Air Shutter Opening Setting Inches (millimeter)		
Model	Natural Gas	Propane Gas
SLBV-35	1/32 (0.795)	3/16" (4.763)
SLBV-40	1/32 (0.795)	3/16" (4.763)

**Figure 13**

**APPLIANCE CHECKOUT**

**Millivolt Appliance Checkout**

The pilot flame should be steady, not lifting or floating. Flame should be blue in color with traces of orange at the outer edge.

The top 3/8" (10 mm) at the pilot generator (thermopile) and the top 1/8" minimum (tip) of the quick drop out thermocouple should be engulfed in the pilot flame. The flame should project 1" (25 mm) beyond the hood at all three ports (see **Figure 14**).

To light the burner, refer to the lighting instructions on **Page 22**.

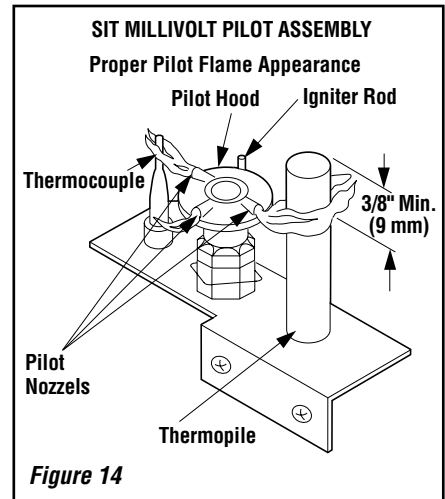

**Figure 14**

**Electronic Appliance Checkout**

To light the burner, refer to the lighting instructions on **Page 24**. Ensure the igniter lights the pilot. The pilot flame should engulf the flame sensor as shown in **Figure 15**.

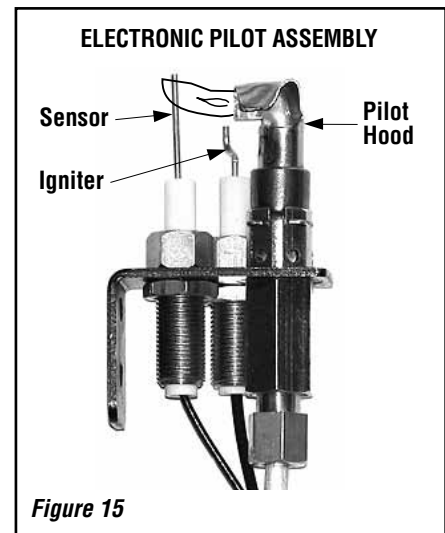

**Figure 15**

NOTE: DIAGRAMS & ILLUSTRATIONS ARE NOT TO SCALE.

## SPILLAGE TEST

After appliance installation, perform this spillage test to verify proper venting conditions:

- 1 - Place unit in its normally-operated condition, that is, with the glass enclosure panel in place.
- 2 - Close all doors and windows in the room. Turn on all exhaust fans in the house.
- 3 - Light the appliance.
- 4 - Wait 15 minutes.
- 5 - To check for venting action, start by holding a smoke producing device below the glass enclosure panel. The smoke should be drawn into the control compartment. Continue the test by moving the smoke-producing device along the entire length of the lower edge of the glass enclosure panel.
- 6 - **If the smoke is NOT drawn into the control compartment, turn off the appliance and call a qualified service technician.**

### Manually-Reset Safety Limit Switch

This appliance is equipped with a manually-reset safety limit switch in the upper RIGHT side of the firebox, behind the right side scoop. Refer to **Figure 16** for its location.

If, during appliance operation, the flame goes out (independently of the burner ON/OFF switch), the safety limit switch may have tripped.

Some causes for a tripped safety limit switch include the following:

- Incorrect flue configuration
- Blocked flue
- Negative pressure inside house

**Before resetting the safety limit switch, have a qualified service technician inspect the fireplace and venting for these conditions and repair as needed.**

**To RESET the safety limit switch**, push the reset button located between the wire terminals on the back of the switch. *Follow the steps below to access the switch (also see **Figure 16-C**).*

**To REPLACE the safety limit switch**, follow the steps below.

**IMPORTANT: This procedure should only be performed by a qualified service technician.**

- 1 - **Turn OFF electrical power to appliance.**
- 2 - **Allow the appliance to cool.**
- 3 - Remove the lower control compartment access panel.
- 4 - *Refer to **Figure 6 on Page 11**.* Open both latches under the firebox floor securing the glass enclosure panel. Remove the panel by tilting it outward at the bottom and lifting it up. Set aside the panel, taking care to protect it from damage.

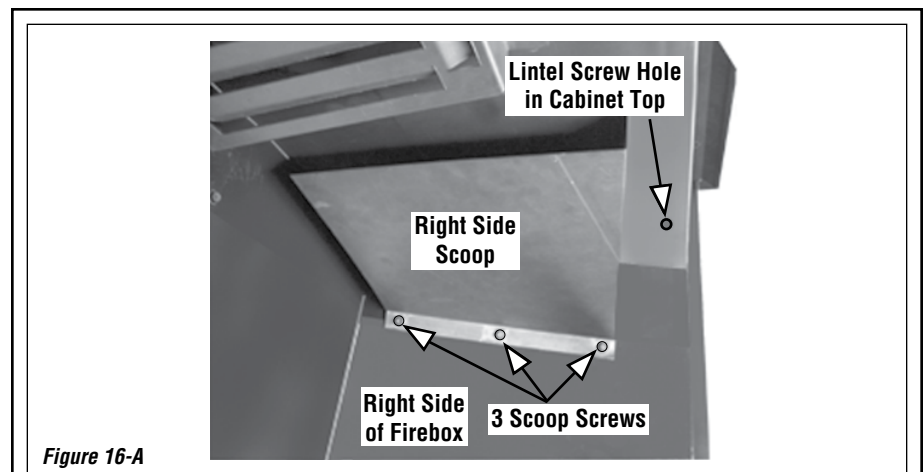

Figure 16-A

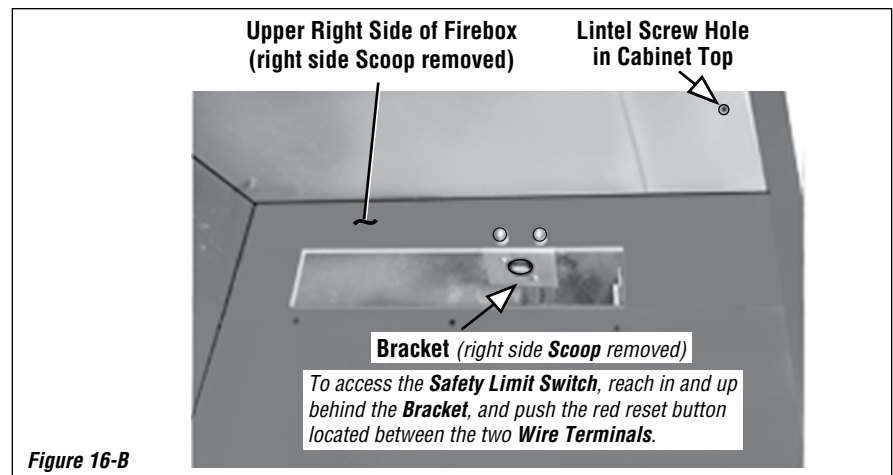

Figure 16-B

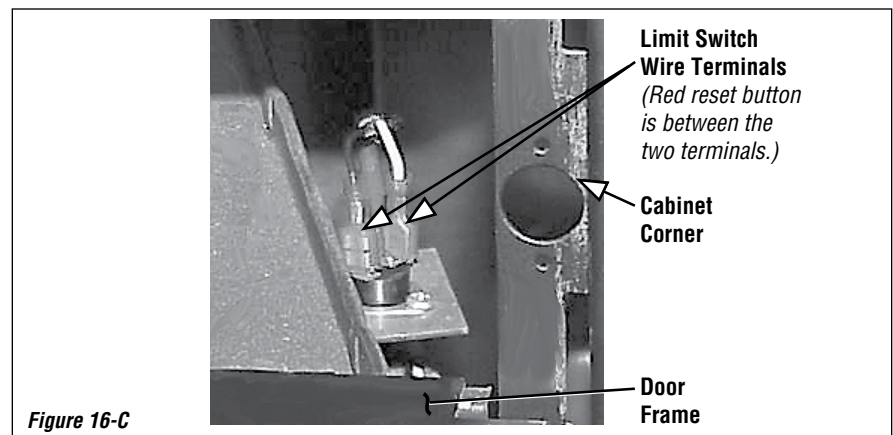

Figure 16-C

### Safety Limit Switch / Reset Button Location

Inside View of Firebox (upper right side)

Figure 16

- 5 - Remove the (3) screws securing the lintel, and then remove the lintel. One of the lintel cabinet top holes is shown in **Figure 16**.
  - 6 - Remove the (3) screws securing the scoop, and then remove the scoop. Refer to **Figure 16** for correct location for model size.
  - 7 - Reset the limit switch per **Figure 16-B**. If unit does not reset, remove the (2) screws securing the safety switch bracket, and pull the switch/bracket assembly (**with low voltage wires attached**) through the side panel slot into the firebox.
  - 8 - Replace the switch, if necessary.
  - 9 - Reinstall the scoop and lintel.
  - 10 - Reinstall the glass enclosure panel and control compartment access panel.
- The appliance should then relight and remain lit. If this does not occur, contact your dealer.

NOTE: DIAGRAMS & ILLUSTRATIONS ARE NOT TO SCALE.

## ORDERING REPLACEMENT PARTS

A complete parts list is found at the end of this manual. Use only parts supplied from the manufacturer.

With proper care and maintenance, your appliance will provide many years of enjoyment. If you should experience any problem, first refer to the troubleshooting guide in this manual. If problem persists, contact your Lennox Hearth Products dealer or distributor.

Normally, all parts should be ordered through your Lennox Hearth Products distributor or dealer. Parts will be shipped at prevailing prices at time of order.

When ordering repair parts, always give the following information:

1. Appliance model number.
2. Appliance serial number.
3. Part number.
4. Part description.
5. Quantity required.
6. Appliance installation date.

If you encounter any problems or have any questions concerning the installation or application of this system, please contact your dealer or distributor.

## PRODUCT REFERENCE INFORMATION

We recommend that you record the important reference information about your fireplace in the space provided below.

Please call Lennox Hearth Products for the phone number of your nearest Lennox Hearth Products dealer who will answer your questions or address your concerns.

**LENNOX HEARTH PRODUCTS**  
**1508 Elm Hill Pike, Suite 108**  
**Nashville, TN 37210**  
**Visit us at [www.Lennox.com](http://www.Lennox.com)**  
**1-800-9-LENNOX**

## UNIT CATALOG NUMBERS AND SHIPPING WEIGHTS

Cat. No.	Model	Shipping Weight	Shipping Volume
H8105	SLBV-35NM	100 lbs.	11.35 cu. ft.
H8106	SLBV-35PM	100 lbs.	11.35 cu. ft.
H8107	SLBV-35NE	100 lbs.	11.35 cu. ft.
H8108	SLBV-40NM	120 lbs.	14.88 cu. ft.
H8109	SLBV-40PM	120 lbs.	14.88 cu. ft.
H8110	SLBV-40NE	120 lbs.	14.88 cu. ft.

### PRODUCT REFERENCE INFORMATION

Model Number \_\_\_\_\_  
 Serial Number \_\_\_\_\_  
 Date Installed \_\_\_\_\_  
 Gas Type Used \_\_\_\_\_  
 Dealer Name \_\_\_\_\_

## WIRING DIAGRAMS

Wiring diagrams are provided for reference purposes only. This information is also provided on schematics attached directly to the appliance on a pullout panel located within the control compartment.

**CAUTION: LABEL ALL WIRES PRIOR TO DISCONNECTION WHEN SERVICING CONTROLS. WIRING ERRORS CAN CAUSE IMPROPER AND DANGEROUS APPLIANCE OPERATION.**

**ATTENTION : AU MOMENT DE L'ENTRETIEN DES COMMANDES, ÉTIQUETEZ TOUS LES FILS AVANT DE LES DÉBRANCHER. DES ERREURS DE CÂBLAGE PEU-VENT ENTRAÎNER UN FONCTIONNEMENT INADÉQUAT ET DANGEREUX.**

### MILLIVOLT WIRING DIAGRAM

**CAUTION: WHEN SERVICING CONTROLS, LABEL ALL WIRES PRIOR TO DISCONNECTION. WIRING ERRORS CAN CAUSE IMPROPER AND DANGEROUS OPERATION.**

**VERIFY PROPER OPERATION AFTER SERVICING.**

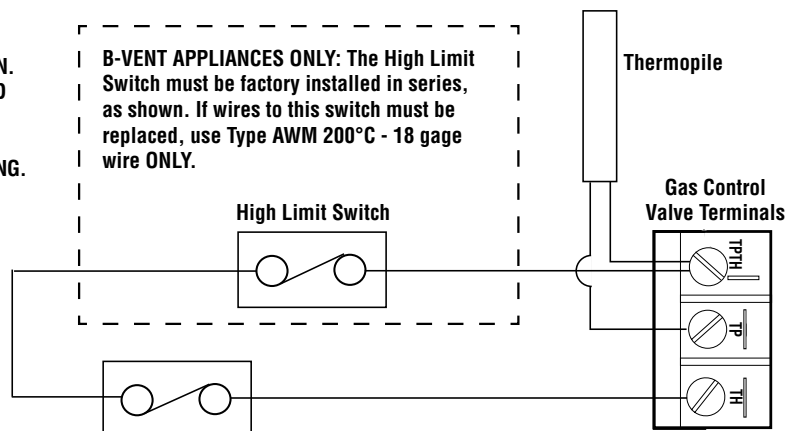

**B-VENT APPLIANCES ONLY: The High Limit Switch must be factory installed in series, as shown. If wires to this switch must be replaced, use Type AWM 200°C - 18 gage wire ONLY.**

**If any of the original wire must be replaced, use Type AWM 105° C - 18 gage wire ONLY.**

\*Control switch options: ON/OFF wall switch, unit-mountable ON/OFF switch, or ON/OFF remote control system

Figure 17

### ELECTRONIC IGNITION WIRING DIAGRAM

**NOTES:**

1. If any of the original wire as supplied must be replaced, use Type AWM 105°C - 18 gage wire ONLY.
  2. 120 VAC, 60 Hz - Less than 3 Amps.
- CAUTION:** label all wires prior to disconnection when servicing controls. Wiring errors can cause improper and dangerous operation. Verify proper operation after servicing.

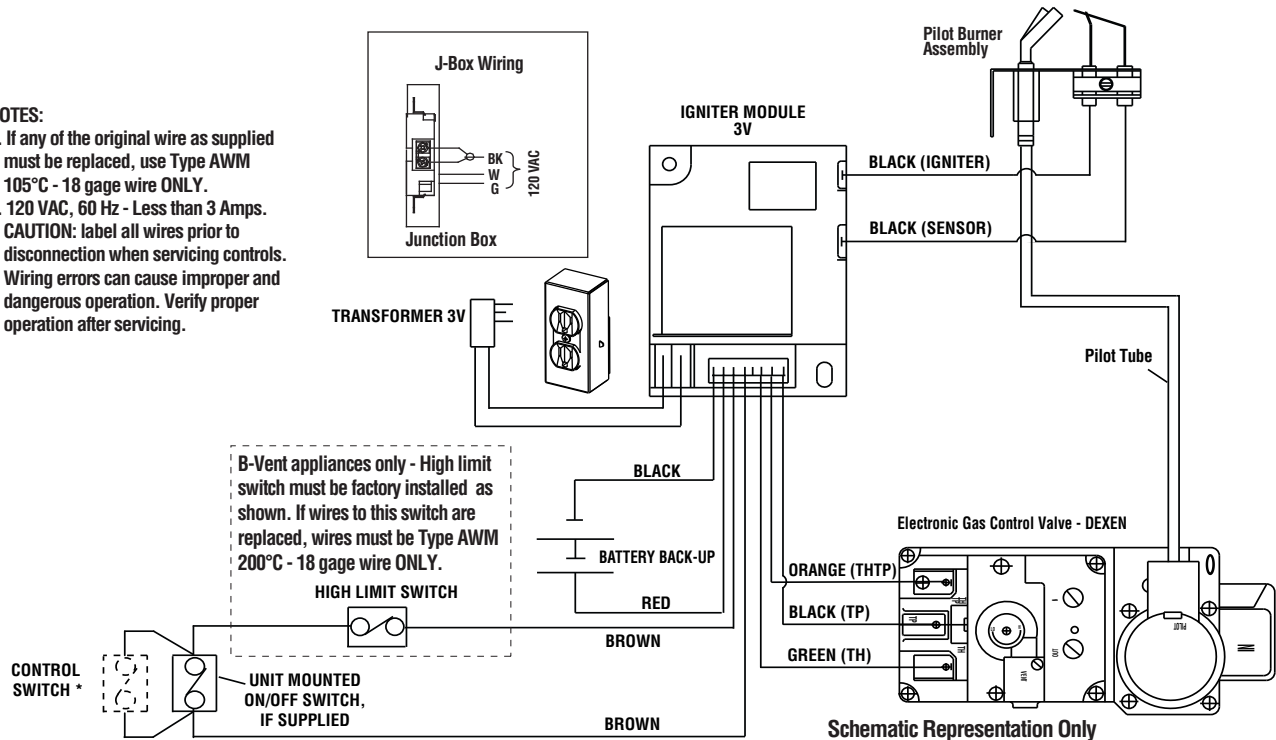

B-Vent appliances only - High limit switch must be factory installed as shown. If wires to this switch are replaced, wires must be Type AWM 200°C - 18 gage wire ONLY.

Schematic Representation Only

\*Control switch options: ON/OFF wall switch, unit-mountable ON/OFF switch, or ON/OFF remote control system

Figure 18

### ACCESSORY COMPONENTS

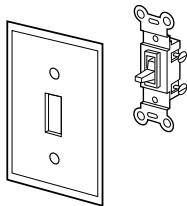

#### ON/OFF Wall Switch Kit

Install the wall switch in a convenient location near the fireplace to provide ON/OFF operation in lieu of a unit-mounted switch.

White Wall Switch Kit		
Cat. No.	Model No.	Description
85L87	FWSK	OFF/ON Wall Switch Kit

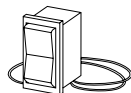

#### Unit-Mountable ON/OFF Switch

Install the ON/OFF switch kit in the mounting bracket to provide ON/OFF operation in lieu of a wall switch.

Unit Moutable ON/OFF Switch Kit		
Cat. No.	Model No.	Description
80L41	FRS	ON/OFF Switch Kit



#### Standard ON/OFF Remote Control System

The Model RCL Standard Remote Control System provides convenient fireplace ON/OFF control in an easy-to-install kit.

The kit includes the following items:

- Hand-held transmitter with ON/OFF buttons that briefly illuminate when pressed, to indicate a signal has been sent
- Remote receiver with wall-mount cover plate (receiver can be wall- or hearth-mounted)
- All required hardware to install the unit
- Detailed instructions

Model RCL is designed to operate with all millivolt and electronic ignition systems, as well as either natural gas or propane gas appliances.

Remote Control Kit, Standard		
Cat. No.	Model No.	Description
H0249	RCL	Std Remote Control System

NOTE: DIAGRAMS & ILLUSTRATIONS ARE NOT TO SCALE.

## ACCESSORY COMPONENTS (continued)

### Style View Screen Doors

These decorative but functional twin-pane screen doors provide a barrier to prevent direct contact with the hot glass surface of the fireplace front enclosure panel. Style View Screen Doors easily install over the standard glass enclosure panel with heavy-duty magnet door latches (no hardware required).

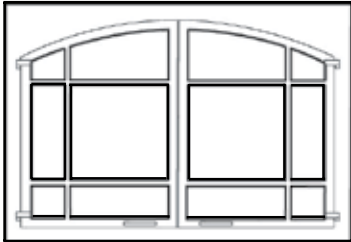

Arch Pane Design

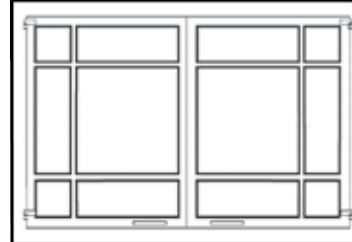

Square Pane Design

ARCH PANE DESIGN KITS			
Cat. No.	Model	Description	Model Series
H6106	APDML35C	35" Arch Pane Door, Painted	SLBV -35
H6107	APDML35SP	35" Arch Pane Door, Satin Pewter	
H6108	APDML40C	40" Arch Pane Door, Painted	SLBV -40
H6109	APDML40SP	40" Arch Pane Door, Satin Pewter	

SQUARE PANE DESIGN KITS			
Cat. No.	Model	Description	Model Series
H6098	SPDML35C	35" Square Pane Door, Painted	SLBV -35
H6099	SPDML35SP	35" Square Pane Door, Satin Pewter	
H6100	SPDML40C	40" Square Pane Door, Painted	SLBV -40
H6101	SPDML40SP	40" Square Pane Door, Satin Pewter	

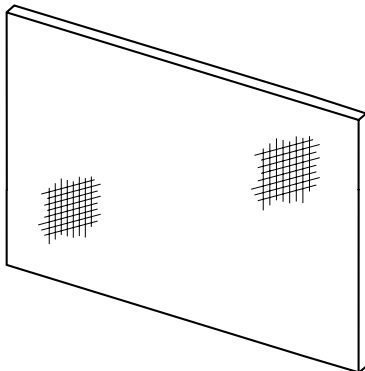

### Barrier Screen Panel Kit

This easy-to-install optional screen panel installs over the standard glass enclosure panel and provides a barrier to prevent direct contact with the hot glass surface.

**Note: Barrier Screen Panels cannot be used in conjunction with Style View doors.**

Barrier Screen Panel Kits		
Cat. No.	Model No.	Models Where Used
H6095	35MSPK	SLBV-35
H3989	40LSPK	SLBV-40

## ACCESSORY COMPONENTS

(continued)

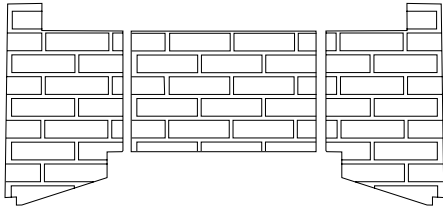

### Ceramic Brickaded Panel Liner Kit

Ceramic Brickaded Panel Liner Kits contain a complete set of ceramic panels with brick-like features and detail.

Ceramic Brick Liner Kits		
Cat. No.	Model No.	Description
H8083	BLPKB-35TB	Brickaded Panel Liner Kit 35" Buff Traditional
H8085	BLPKB-40TB	Brickaded Panel Liner Kit 40" Buff Traditional

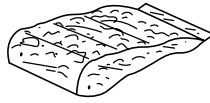

- **Bag of Glowing Embers (Rockwool)**
- **Bag of Decorative Volcanic Stone**

Order replacement Glowing Ember material (rockwool) or Decorative Volcanic Stone as needed for periodic maintenance of the appliance.

Decorative Firebox Accessories (all models)		
Cat. No.	Model No.	Description
88L53	FGE	Bag of Glowing Embers
80L42	FDVS	Bag of Decorative Volcanic Stone



### Touch-Up Paint Kit

Use the touch-up paint to cover minor scratches or discoloration of the appliance's black painted surfaces.

Touch-Up Paint Kit (all models)		
Cat. No.	Model No.	Description
90L73	FTPK-B	Touch-Up Paint (Black)

NOTE: DIAGRAMS & ILLUSTRATIONS ARE NOT TO SCALE.

## LIGHTING INSTRUCTIONS – MILLIVOLT GAS VALVE



## FOR YOUR SAFETY READ BEFORE LIGHTING

**WARNING:** If you do not follow these instructions exactly, a fire or explosion may result causing property damage, personal injury or loss of life.

A. This appliance has a pilot which must be lighted by a piezo igniter. When lighting the pilot, follow these instructions exactly.

B. BEFORE LIGHTING smell all around the appliance area for gas. Be sure to smell next to the floor because some gas is heavier than air and will settle on the floor.

## WHAT TO DO IF YOU SMELL GAS:

- Do not try to light any appliance.
- Do not touch any electric switch; do not use any phone in your building.



- Immediately call your gas supplier from a neighbor's phone. Follow the gas supplier's instructions.

- If you cannot reach your gas supplier, call the fire department.

C. Use only your hand to push in or turn the gas control knob. Never use tools. If the knob will not push in or turn by hand, don't try to repair it, call a qualified service technician. Force or attempted repair may result in a fire or explosion.

D. Do not use this appliance if any part has been under water. Immediately call a qualified service technician to inspect the appliance and to replace any part of the control system and any gas control which has been under water.

## LIGHTING INSTRUCTIONS

1. STOP! Read the safety information above on this label.
2. (If applicable) Set the thermostat to lowest setting. Turn wall on/off switch, unit mounted on/off switch or remote control switch "OFF."
3. Turn OFF all electric power to the appliance.
4. Access the control compartment.
5. Push in gas control knob slightly and turn clockwise  to "OFF."  
NOTE: Knob cannot be turned from "PILOT" to "OFF" unless knob is pushed in slightly. Do Not force.
6. Wait five (5) minutes to clear out any gas. Then smell for gas, including near the floor. If you smell gas, STOP! Follow "B" in the safety information above on this label. If you don't smell gas, go to the next step.
7. Find pilot - located in firebox on the same plane as the top of the burner.
8. Turn knob on gas control counterclockwise  to "PILOT."
9. Push in control knob all the way and hold in. Immediately light the pilot by triggering the piezo igniter (pushing the button) until pilot lights. Continue to hold the control knob in for about 1-1/2 minutes after the pilot is lit. Release knob and it will pop back up. Pilot should remain lit. If it goes out, repeat steps 5 through 9.
  - If knob does not pop up when released, stop and immediately call your service technician or gas supplier.

- If the pilot will not stay lit after several tries, turn the gas control knob to "OFF" and call your service technician or gas supplier.
10. Turn gas control knob counterclockwise  to "ON."
  11. Close control compartment.
  12. (If applicable) Turn on all electrical power to the appliance.
  13. (If applicable) Set thermostat to desired setting. Turn wall on/off switch, unit mounted on/off switch or remote control switch "ON."

Gas Control Valves

Pilot Assemblies

SIT

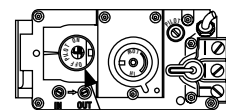

Gas Control Knobs

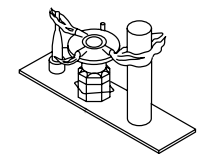

Robertshaw

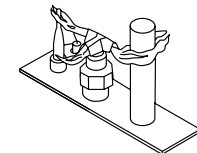
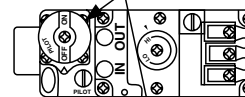

Honeywell

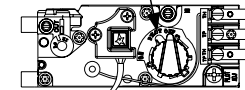

## TO TURN OFF GAS TO APPLIANCE

1. (If applicable) Set the thermostat to lowest setting. Turn wall on/off switch, unit mounted on/off switch or remote control switch "OFF."
2. Turn OFF all electric power to the appliance, if service is to be performed.
3. Access the control compartment.

4. Push in gas control knob slightly and turn clockwise  to "OFF." Do not force.
5. Close the main line gas shut-off valve.
6. Close control compartment.

62L2901



## INSTRUCTIONS D'ALLUMAGE – VANNE GAZ MILLIVOLT



## POUR PLUS DE SÉCURITÉ, LIRE AVANT D'ALLUMER

**AVERTISSEMENT.** Quiconque ne respecte pas à la lettre les instructions dans la présente notice risque de déclencher un incendie ou une explosion entraînant des dommages, des blessures ou la mort.

A. Cet appareil est muni d'une veilleuse qui doit être allumée avec un allumeur piézo-électrique. Respectez les instructions ci-dessous à la lettre.

B. **AVANT L'ALLUMAGE:** Avant d'allumer la veilleuse, reniflez tout autour de l'appareil pour déceler une odeur de gaz. Reniflez près du plancher, car certains gaz sont plus lourds que l'air et peuvent s'accumuler au niveau du sol.

**QUE FAIRE SI VOUS SENTEZ UNE ODEUR DE GAZ :**

- Ne pas tenter d'allumer d'appareil.
- Ne touchez à aucun interrupteur ; ne pas vous servir des téléphones se trouvant dans le bâtiment.

- Appelez immédiatement votre fournisseur de gaz depuis un voisin. Suivez les instructions du fournisseur.
- Si vous ne pouvez rejoindre le fournisseur, appelez le service des incendies.

C. Ne pousser ou tourner la manette d'admission du gaz qu'à la main. Ne jamais employer d'outil à cette fin. Si la manette reste coincée, ne tentez pas de la réparer; appelez un technicien qualifié. Quiconque tente de forcer la manette ou de la réparer peut provoquer une explosion ou un incendie.

D. N'utilisez pas cet appareil s'il a été plongé dans l'eau, même partiellement. Faites inspecter l'appareil par un technicien qualifié et remplacez toute partie du système de contrôle et toute commande qui ont été plongés dans l'eau.

## INSTRUCTIONS D'ALLUMAGE

1. **ARRÊTEZ !** Lisez les instructions de sécurité sur la portion supérieure de cette étiquette.
2. (Si applicable) Réglez le thermostat à la température la plus basse. Tournez l'interrupteur murale, l'interrupteur sur l'unité ou le contrôle à distance à "OFF."
3. Coupez l'alimentation électrique de l'appareil.
4. Accédez au compartiment de contrôle.
5. Enfoncez légèrement le bouton de réglage du gaz et tournez-le dans le sens des aiguilles d'une montre jusqu'à la position d'arrêt "OFF". Remarque: Il est impossible de tourner le bouton de "PILOT" à "OFF" à moins qu'il ne soit légèrement enfoncé. Ne le forcez pas.
6. Attendre cinq (5) minutes pour laisser échapper tout le gaz. Reniflez tout autour de l'appareil, y compris près du plancher, pour déceler une odeur de gaz. Si vous sentez une odeur de gaz, **ARRÊTEZ !** Passez à l'étape B des instructions de sécurité sur la portion supérieure de cette étiquette. S'il n'y a pas d'odeur de gaz, passez à l'étape suivante.
7. Trouver le pilote – Situé dans l'âtre sur la même surface que le dessus du brûleur.
8. Tournez le bouton de contrôle sur la valve à gaz dans le sens antihoraire vers "Pilote".
9. Enfoncez le bouton de réglage jusqu'au fond et gardez-le enfoncé. Allumez immédiatement la veilleuse en déclenchant l'allume-gaz à étincelle (en poussant le bouton) jusqu'à ce que la veilleuse s'enflamme. Continuez de tenir le bouton de réglage enfoncé pendant environ 90 secondes après l'allumage de la veilleuse. Relâchez le bouton et il sortira subitement. La veilleuse devrait rester allumée. Si elle s'éteint, répétez les étapes 5 à 8 inclusivement.

- Si la manette ne se soulève pas d'elle-même lorsqu'on la relâche, arrêter et appeler immédiatement un technicien qualifié ou le fournisseur de gaz.
  - Si la veilleuse ne reste pas allumée après plusieurs tentatives, réglez la manette d'admission du gaz à la position OFF et appelez un technicien qualifié ou le fournisseur de gaz.
10. Tournez le bouton de réglage du gaz en sens inverse des aiguilles d'une montre jusqu'à sa position de marche "ON".
  11. Fermer le compartiment de contrôle.
  12. (Si applicable) Mettez l'appareil sous tension.
  13. (Si applicable) Réglez le thermostat à la température désirée. Tournez l'interrupteur murale, l'interrupteur sur l'unité ou le contrôle à distance à "ON."

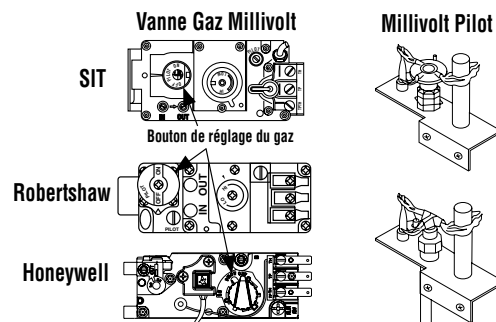

## COMMENT COUPER L'ADMISSION DE GAZ DE L'APPAREIL

1. (Si applicable) Réglez le thermostat à la température la plus basse. Tournez l'interrupteur murale, l'interrupteur sur l'unité ou le contrôle à distance à "OFF."
2. Coupez l'alimentation électrique de l'appareil s'il faut procéder à l'entretien.
3. Accédez au compartiment de contrôle.
4. Enfoncez légèrement le bouton de réglage du gaz et tournez-le dans le sens des aiguilles d'une montre jusqu'à la position d'arrêt "OFF". Ne forcez pas le bouton.
5. Fermer la valve de gaz principale.
6. Fermer le compartiment de contrôle.

62L3001

## LIGHTING INSTRUCTIONS — ELECTRONIC



## FOR YOUR SAFETY READ BEFORE OPERATING

**WARNING:** If you do not follow these instructions exactly, a fire or explosion may result causing property damage, personal injury or loss of life.

A. This appliance is equipped with an ignition device which automatically lights the pilot. Do not try to light the pilot by hand.

B. BEFORE OPERATING smell all around the appliance area for gas. Be sure to smell next to the floor because some gas is heavier than air and will settle on the floor.

## WHAT TO DO IF YOU SMELL GAS:

- Do not try to light any appliance.
- Do not touch any electric switch; do not use any phone in your building.

- Immediately call your gas supplier from a neighbor's phone. Follow the gas supplier's instructions.

- If you cannot reach your gas supplier, call the fire department.

C. If any portion of this appliance does not operate as the instructions indicate, do not try to repair it, call a qualified service technician. Do not use tools. Force or attempted repair may result in a fire or explosion.

D. Do not use this appliance if any part has been under water. Immediately call a qualified service technician to inspect the appliance and to replace any part of the control system and any gas control which has been under water.

## OPERATING INSTRUCTIONS

1. STOP! Read the safety information above on this label.
2. (If applicable) Set the thermostat to lowest setting. Turn wall on/off switch, unit mounted on/off switch or remote control switch "OFF." If used, remove the batteries from the battery holder.
3. Turn OFF all electric power to the appliance.
4. This appliance is equipped with an ignition device which automatically lights the pilot. Do not try to light the pilot by hand.
5. Access the control compartment.
6. Wait five (5) minutes to clear out any gas. If you smell gas, STOP! Follow "B" in the safety information above on this label. If you don't smell gas, go to the next step.
7. Turn on all electrical power to the appliance.
8. (If applicable) Set thermostat to desired setting. Turn wall on/off switch, unit mounted on/off switch or remote control switch "ON." Replace the batteries in the battery holder, if used.

9. Close control compartment.

10. If the appliance will not operate, follow the instructions "To Turn Off Gas To Appliance" and call your service technician or gas supplier.

Electronic Gas Control Valve - DEXEN

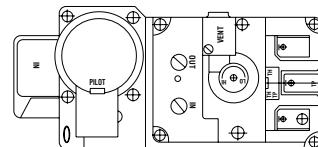

Electronic Pilot Assembly



## TO TURN OFF GAS TO APPLIANCE

1. (If applicable) Set the thermostat to lowest setting. Turn wall on/off switch, unit mounted on/off switch or remote control switch "OFF."
2. Turn OFF all electric power to the appliance and remove

backup batteries, if service is to be performed.

3. Access the control compartment.
4. Close the main line gas shut-off valve.
5. Close control compartment.

100963-01

## INSTRUCTIONS D'ALLUMAGE — ELECTRONIC



## POUR PLUS DE SÉCURITÉ LIRE AVANT DE METTRE EN MARCHÉ

**AVERTISSEMENT.** Quiconque ne respecte pas à la lettre les instructions dans la présente notice risque de déclencher un incendie ou une explosion entraînant des dommages, des blessures ou la mort.

- A. Cet appareil est muni d'un dispositif d'allumage qui allume automatiquement la veilleuse. Ne tentez pas d'allumer la veilleuse manuellement.
- B. **AVANT DE FAIRE FONCTIONNER**, reniflez tout autour de l'appareil pour déceler une odeur de gaz. Reniflez près du plancher, car certains gaz sont plus lourds que l'air et peuvent s'accumuler au niveau du sol.

## QUE FAIRE SI VOUS SENTEZ UNE ODEUR DE GAZ :

- Ne pas tenter d'allumer d'appareil.
- Ne touchez à aucun interrupteur; ne pas vous servir des téléphones se trouvant dans le bâtiment.

- Appelez immédiatement votre fournisseur de gaz depuis un voisin. Suivez les instructions du fournisseur.
- Si vous ne pouvez rejoindre le fournisseur, appelez le service des incendies.
- C. Si un élément de cette unité ne fonctionne pas tel que décrit dans les instructions, n'essayez pas de le réparer, appelez un technicien qualifié. N'utilisez pas d'outils. Le fait de forcer la manette ou de la réparer peut déclencher une explosion ou un incendie.
- D. N'utilisez pas cet appareil s'il a été plongé dans l'eau, même partiellement. Faites inspecter l'appareil par un technicien qualifié et remplacez toute partie du système de contrôle et toute commande qui ont été plongés dans l'eau.

## INSTRUCTIONS DE MISE EN MARCHÉ

1. **ARRÊTEZ !** Lisez les instructions de sécurité sur la portion supérieure de cette étiquette.
2. (Si applicable) Réglez le thermostat à la température la plus basse. Tournez l'interrupteur murale, l'interrupteur sur l'unité ou le contrôle à distance à "OFF." Si l'appareil fonctionne avec des batteries, retirez-les de leur support.
3. Coupez l'alimentation électrique de l'appareil.
4. Cet appareil est muni d'un dispositif d'allumage qui allume automatiquement la veilleuse. Ne tentez pas d'allumer la veilleuse manuellement.
5. Accédez au compartiment de contrôle.
6. Attendez cinq (5) minutes pour laisser échapper tout le gaz. Reniflez tout autour de l'appareil, y compris près du plancher, pour déceler une odeur de gaz. Si vous sentez une odeur de gaz, **ARRÊTEZ !** Passez à l'étape B des instructions de sécurité sur la portion supérieure de cette étiquette. S'il n'y a pas d'odeur de gaz, passez à l'étape suivante.
7. Mettez l'appareil sous tension.
8. (Si applicable) Réglez le thermostat à la température désirée. Tournez l'interrupteur murale, l'interrupteur sur l'unité ou le contrôle à distance à "ON." Remplacez les batteries dans leur support.
9. Fermez le compartiment de contrôle.
10. Si l'appareil ne se met pas en marche, suivez les instructions intitulées « Comment couper l'admission de gaz de l'appareil » et appelez un technicien qualifié ou le fournisseur de gaz.

Valve électronique - DEXEN

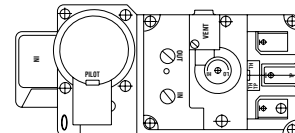

Veilleuse de l'appareil électronique



## COMMENT COUPER L'ADMISSION DE GAZ DE L'APPAREIL

1. (Si applicable) Réglez le thermostat à la température la plus basse. Tournez l'interrupteur murale, l'interrupteur sur l'unité ou le contrôle à distance à "OFF."
2. Couper toute alimentation électrique et retirer les batteries de leur support, si un entretien doit être fait sur l'unité.
3. Accédez au compartiment de contrôle.
4. Fermer la valve de gaz principale.
5. Fermer le compartiment de contrôle.

100964-01

## MAINTENANCE SCHEDULE

### Annually (before burning season)

MAINTENANCE TASK	ACCOMPLISHING PERSON	PROCEDURE
Inspect/Clean Burner, Logs, and Controls	Qualified Service Technician	Inspect valve and ensure it is properly operating. Check piping for leaks. Vacuum the control compartment, logs, and burner area.
Check Flame Patterns and Flame Height	Qualified Service Technician	Refer to <b>Figures 11 and 12 on Page 15</b> and verify the flame pattern and height displayed by the appliance conforms to the picture. Flames must not impinge on the logs. Ensure flames are steady (not lifting or floating).
Inspect/Clean Pilot and Burner	Qualified Service Technician	Refer to <b>Figure 14 (SIT Millivolt) or Figure 15 (Electronic) on Page 16</b> . Remove any surface build-up on pilot and burner assembly. Wipe the pilot nozzles, igniter/flame rod and hood. Ensure the pilot flame engulfs the flame sensor as shown.
Check Vent System	Qualified Service Technician	Inspect the vent system at the top and at the base (within the firebox) for signs of blockage or obstruction. Look for any signs of dislocation or deterioration of the vent components. Reconnect or replace, as needed.  <i>Note: Excessive condensation can cause corrosion of caps, pipe and fittings (excessive condensation can be caused by long lateral runs, too many elbows and/or exterior portions of the system being exposed to cold weather). Also inspect wall straps or plumbers's tape to ensure it is secure and in place.</i>
Appliance Checkout	Qualified Service Technician	Perform the appropriate appliance checkout procedure detailed in this manual.
Replace Glowing Ember Materials (Rockwool)	Homeowner/Qualified Service Technician	Remove old glowing ember materials (rockwool) and vacuum the ember placement area. Place new embers as described and shown in <b>Figures 8–10</b> .

### Periodically (after burning season)

MAINTENANCE TASK	ACCOMPLISHING PERSON	PROCEDURE
Clean Firebox Interior	Homeowner	Carefully remove logs, glowing embers (rockwool), and volcanic stone. Vacuum out interior of the firebox. Clean firebox walls and log grate. Replace logs, rockwool, and volcanic stone as detailed in this manual.
Check Flame Patterns and Flame Height	Homeowner	Refer to <b>Figures 11 and 12 on Page 15</b> and verify the flame pattern and height displayed by the appliance conforms to the picture. Flames must not impinge on the logs.
Check Vent System	Homeowner	Inspect the vent system at the top and at the base (within the firebox) for signs of blockage or obstruction. Look for any signs of dislocation of the vent components. Reconnect or replace, as needed.
Clean Front Glass Enclosure Panel	Homeowner	Clean as necessary following the directions provided in this manual. <b>DO NOT TOUCH OR CLEAN GLASS WHILE HOT.</b>

## TROUBLESHOOTING GUIDE – MILLIVOLT CONTROL SYSTEM

**Note:** Before troubleshooting the gas control system, make sure the external gas shut off valve (located at gas supply inlet) and wall switch (if applicable) are in the “ON” position.

**Important:** Valve system troubleshooting should only be performed by a qualified service technician.

SYMPTOM	POSSIBLE CAUSES	CORRECTIVE ACTION
<p>1. Spark igniter will not light pilot after repeated triggering of igniter button.</p> <p><b>WARNING: if the pilot will not light after 1 minute of lighting attempts, wait at least 5 minutes for gas to clear before attempting again.</b></p>	A. Defective igniter (no spark at electrode).	Check for spark at electrode and pilot; if no spark and electrode wire is properly connected, replace igniter.
	B. Defective or misaligned electrode at pilot (spark at electrode).	Using a match, light pilot. If pilot lights, turn off pilot and trigger the igniter button again. If pilot lights, an improper gas mixture caused the bad lighting and a longer purge period is recommended. If pilot will not light, check gap at electrode and pilot; it should be 1/8" to have a strong spark.
	C. Gas supply pressure errant.	Check inlet gas pressure. It should be within the limits as marked on the rating plate.
	D. Pilot orifice plugged.	Clean or replace pilot orifice.
2. Pilot will not stay lit after carefully following the lighting instructions.	A. Defective pilot generator (thermocouple).	Check pilot flame, it must impinge on thermocouple (see <b>Figure 14</b> on <b>Page 16</b> ). Clean and/or adjust pilot for maximum flame impingement on thermocouple. Ensure that the connection between the valve and thermocouple are tight and secure.
<p>3. Pilot burning; no gas to burner; valve knob set to “ON”; and burner OFF/ON switch (unit-mounted switch, wall switch, or remote control) is set to “ON.”</p>	A. Wall switch or wires defective.	Check wall switch and wires for proper connections. Jumper wire across terminals at wall switch, if burner comes on, replace defective wall switch. If okay, jumper wires across wall switch wires at valve, if burner comes on, wires are faulty or connections are bad.
	B. Thermopile may not be generating sufficient millivolts.	Check thermopile with millivolt meter. Take reading at thermopile terminals of gas valve. Should read 325 millivolts minimum with optional wall switch in the “OFF” position. Replace faulty thermopile if reading is below specified minimum.
	C. Plugged burner orifice.	Check burner orifice for blockage; remove, if found.
	D. OFF/ON Switch and *Remote Switch are in the <b>ON</b> position, resulting in excessive resistance.	When turning on the burner using a *remote switch, ensure that the standard OFF/ON switch is in the “OFF” position. If both switches are in the “ON” position, it may result in excessive resistance (and millivolt drainage) and the burner may not come on.
4. Frequent pilot/burner outage problem.	A. Pilot flame may be too low or blowing (high), causing the pilot/valve safety to drop out.	Clean and/or adjust pilot flame for maximum flame impingement on thermocouple (see <b>Figure 14</b> on <b>Page 16</b> ).

## TROUBLESHOOTING GUIDE – ELECTRONIC IGNITION SYSTEM

**Note:** Before troubleshooting, make sure the appliance main line gas shut-off valve, gas control valve, and wall switch (if applicable) are in the “ON” position.

**Important:** Valve system troubleshooting should only be performed by a qualified service technician.

SYMPTOM	POSSIBLE CAUSES	CORRECTIVE ACTION
1. Nothing happens when ON/OFF switch is turned on (pilot does not spark).	<b>A.</b> Low voltage/or bad lead wires.	Check voltage on AC terminals of module an/or batteries. Voltage should be between 2.7 and 3.2 VAC. Make sure wire connections are secure.
	<b>B.</b> Damaged igniter wire.	Check for visible cracked casing, cuts, etc.
	<b>C.</b> Damaged pilot assembly.	Check pilot assembly for visibly broken spark electrode, etc.
	<b>D.</b> Batteries Low	Check voltage on DC terminal of batteries. The value should be around 3.0V.
2. Main burner does not light and igniter is sparking.	<b>A.</b> No fuel supply.	Make sure gas supply is turned on.
	<b>B.</b> Loose sensor wire.	Make sure sensor wire connection is securely connected.
	<b>C.</b> Loose wires to valve.	Make sure black, green, and orange wires are securely connected to the valve.
	<b>D.</b> Loose wires to ignition module.	Make sure black sensor wire and black igniter wire are securely connected to ignition module.
	<b>E.</b> Air in gas line.	Purge gas line of air.
	<b>F.</b> Low voltage.	Test voltage at AC terminals of module and/or batteries. Voltage should be between 2.7 and 3.2 VAC.
3. Main burner lights; then shuts off unexpectedly.	<b>A.</b> Gas supply is set to “OFF.”	Set gas supply to “ON.”
	<b>B.</b> Loose wires to valve.	Make sure black, green, and orange wires are securely connected to the valve.
	<b>C.</b> Loose wires to ignition module.	Make sure black sensor wire (“S”) and black igniter wire (“I”) are securely connected to ignition module.
	<b>D.</b> Flame does not engulf flame sensor.	Check location of sensor.
	<b>E.</b> Obstructed vent system.	Check vent system for obstructions. Reset safety limit switch ( <b>see Page 17</b> ).
4. Soot on logs and/or glass.	<b>A.</b> Flame impingement on the log.	Check for proper log placement.
	<b>B.</b> Improper air shutter opening.	Check for proper air shutter openings.

## REPLACEMENT PARTS LIST

Item No.	Description	SLBV-35		SLBV-40	
		Part No.	Qty.	Part No.	Qty.
1	Hood	H7266	1	H7267	1
2	Lower Control Compartment Panel	H7262	1	H7263	1
3	Enclosure, Glass Front (Complete)	H7264	1	H7265	1
4	Door Latch Spring	H1264	2	H1264	2
5	Log Set (Complete)	H7244	1	H7245	1
6	Burner Assembly	H7253	1	H7259	1
7	Orifice, Main Burner - Natural Gas	H1236	1	99K75	1
	Orifice, Main Burner - Propane Gas	62L37	1	19L52	1
8	Bag of Glowing Embers (Rockwool)	88L53	1	88L53	1
	Bag of Decorative Volcanic Stone	80L42	1	80L42	1
9	Orifice Holder	H7257	1	H7257	1
10	Gas Line Flexible Connector	93L32	1	93L32	1
11	Sub-Floor	H7450	1	H7462	1
12	Limit Switch	H1614	1	H1614	1

### Gas Controls - SIT Millivolt

Item No.	Description	Natural Gas		Propane Gas	
		Part No.	Qty.	Part No.	Qty.
15	Gas Valve, SIT	H6209	1	88J53	1
16	Piezo Igniter	10K86	1	10K86	1
	Piezo Igniter Wire	56L21	1	56L21	1
17	Pilot Assembly	69L17	1	69L18	1
18	Pilot Generator	60J79	1	60J79	1
19	Thermocouple	74L57	1	74L57	1
20	Pilot Tube	74L56	1	74L56	1
21	Electrode and Cable	H6212	1	H6212	1

Contact an Authorized Lennox Hearth Products dealer to obtain any of these parts. Never use substitute materials. Use of non-approved parts can result in poor performance and safety hazards.

### ⚠ WARNING

Failure to position the parts in accordance with these diagrams or failure to use only parts specifically approved with this appliance may result in property damage or personal injury.

### ⚠ AVERTISSEMENT

Risque de dommages ou de blessures si les pièces ne sont pas installées conformément à ces schémas et ou si des pièces autres que celles spécifiquement approuvées avec cet appareil sont utilisées.

### Gas Controls - Dexen Electronic

Item No.	Description	Natural Gas	
		Part No.	Qty.
28	Gas Valve, Dexen	H4681	1
29	Pilot Assembly	H4673	1
30	Igniter Module	H4674	1
31	Battery Holder	H4675	1
32	Wire Harness	H4676	1
33	Adaptor	H4677	1

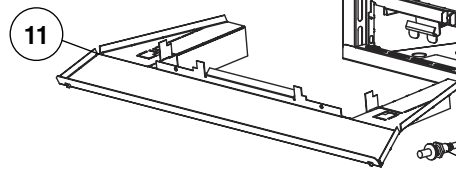
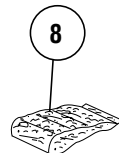
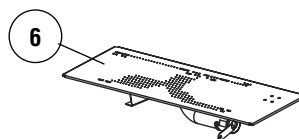
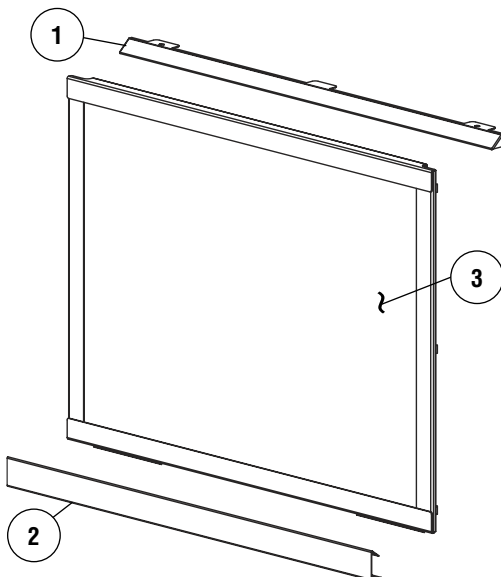
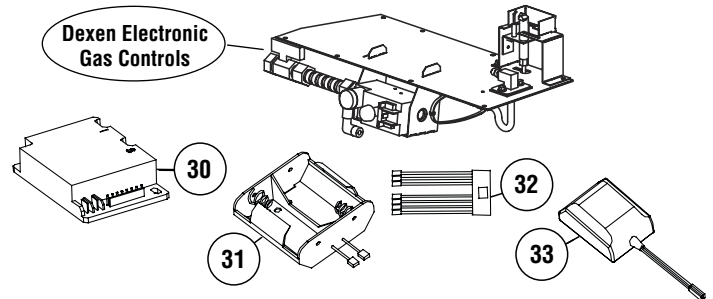
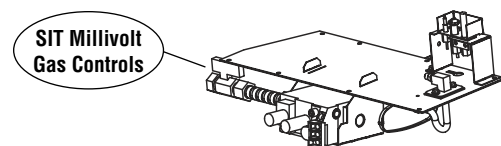

NOTE: DIAGRAMS & ILLUSTRATIONS ARE NOT TO SCALE.



---

Lennox Hearth Products reserves the right to make changes at any time, without notice, in design, materials, specifications, prices and also to discontinue colors, styles and products. Consult your local distributor for fireplace code information.



Printed in U.S.A. © 2010 Lennox Hearth Products

**P/N 506010-02 Rev. B 06/2011**

**1508 Elm Hill Pike, Suite 108 • Nashville, TN 37210**

## Free Manuals Download Website

<http://myh66.com>

<http://usermanuals.us>

<http://www.somanuals.com>

<http://www.4manuals.cc>

<http://www.manual-lib.com>

<http://www.404manual.com>

<http://www.luxmanual.com>

<http://aubethermostatmanual.com>

Golf course search by state

<http://golfingnear.com>

Email search by domain

<http://emailbydomain.com>

Auto manuals search

<http://auto.somanuals.com>

TV manuals search

<http://tv.somanuals.com>