



Professional Mixing Controller

PCV-175

OWNER'S MANUAL

VESTAX CORPORATION

1-18-6 Wakabayashi, Setagaya-ku, Tokyo 154-0023 Japan

Phone:03-3412-7011 Fax:03-3412-7013

Web:www.vestax.jp

VESTAX America

2750N. 29th Avenue, Suite 115, Hollywood, FL33020.

Phone:954-926-6622 Fax:954-926-3304

Web:www.vestaxdj.com

VESTAX (Europe)Ltd.

Unit 5 Riverwey Industrial Park Alton, Hampshire GU34 2QL England, U.K

Phone:(0)1420-83000 Fax:(0)1420-80040

Web:www.vestax.co.uk

Vestax Technical Center of America

8489 W.Third Street Ste.1044 Los Angeles CA 90048

Phone:1-323-801-2111 Fax:1-323-801-2112

Vestax Europe Technical Support

Rheinstr.213 D-53332 Bornheim Germany

Phone:49(0)2222-95-23-72 Fax:49(0)2222-95-23-74

CONGRATULATIONS!

The PCV-175 is a high profile mixer designed to meet various professional requirements of today's dance music DJs. Please read this owner's manual carefully before you start to use your mixer, so that you will fully understand all of the special features and enjoy the full use of the product.

CONTENTS

C A U T I O N	1
IMPORTANT SAFEGUARDS	2
F E A T U R E S	3
F U N C T I O N S	4
PROGRAM INPUT SECTION	5
HOW TO CHANGE THE FADER UNIT	6
MIC. MASTER SECTION	7
REAR PANEL SECTION	8
CONNECTIONS	9
SPECIFICATIONS	10

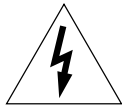

CAUTION

RISK OF ELECTRIC SHOCK DO NOT OPEN



**CAUTION : TO REDUCE THE RISK OF ELECTRIC SHOCK
DO NOT REMOVE COVER (OR BACK)
NO USER-SERVICEABLE PARTS INSIDE
REFER SERVICING TO QUALIFIED SERVICE PERSONNEL**



The lightning flash with arrowhead symbol, within an equilateral triangle, is intended to alert the user to the presence of uninsulated "dangerous voltage" within the product's enclosure that may be of sufficient magnitude to constitute a risk of electric shock to persons.



The exclamation point within an equilateral triangle is intended to alert the user to the presence of important operating and maintenance (servicing) instructions in the literature accompanying the appliance.

**TO REDUCE THE RISK OF FIRE OR ELECTRIC SHOCK, DO NOT
EXPOSE THIS APPLIANCE TO RAIN OR MOISTURE.**

IMPORTANT SAFEGUARDS

READ BEFORE OPERATING EQUIPMENT

This product was designed and manufactured to meet strict quality and safety standards. There are, however, some installation and operation precautions which you should be particularly aware of.

1. Read instructions-All the safety and operating instructions should be read before the appliance is operated.
2. Retain instructions-The safety and operating instructions should be retained for future reference.
3. Heed Warnings-All warnings on the appliance and in the operating instructions should be adhered to.
4. Follow Instructions-All operating and use instructions should be followed.
5. Cleaning-Do not use liquid cleaners or aerosol cleaners. Use a damp cloth for cleaning.
6. Attachments-Do not use attachments not recommended by the product manufacturer as they may cause hazards.
7. Water and Moisture-Do not use this product near water-for example, near a bath tub, wash bowl, kitchen sink, or laundry tub, in a wet basement, or near a swimming pool, and the like.
8. Accessories-Do not place this product on an unstable cart, stand, tripod, or table. The product may fall, causing serious injury to a child or adult, and serious damage to the appliance. Use only with a cart, stand, tripod, bracket, or table recommended by the manufacturer, or sold with product. Any mounting of the appliance should follow the manufacturer's instructions, and should use a mounting accessory recommended by the manufacturer.
9. This product should never be placed near or over a radiator or heat register. This product should not be placed in a built-in installation such as a bookcase or rack unless proper ventilation is provided or the manufacturer's instructions have been adhered to.
10. Power sources-This product should be operated only from the type of power source indicated on the marking label. If you are not sure of the type of power supply to your home, consult your appliance dealer or local power company.
11. Lightning-For added protection of this product during a lightning storm, or when it is left unattended and unused for long periods of time, unplug it from the wall outlet. This will prevent damage to the product due to lightning and power-line surges.
12. Overloading-Do not overload wall outlets and extension cords as this can result in a risk of fire or electric shock.
13. Object and Liquid Entry-Never push objects of any kind into this product through openings as they may touch dangerous voltage points or short-out parts that could result in a fire or electric shock. Never spill liquid of any kind on the product.
14. Servicing-Do not attempt to service product yourself as opening or removing covers may expose you to dangerous voltage or other hazards. Refer all servicing to qualified personnel.

-
15. Damage Requiring Service-Unplug this product from the wall outlet and refer servicing to qualified service personnel under the following conditions:
 - a. When the power-supply cord or plug is damaged.
 - b. If liquid has been spilled or objects have fallen into the product.
 - c. If the product has been exposed to rain or water.
 - d. If the product does not operate normally by following the operating instructions. Adjust only those controls that are covered by the operating instructions as an improper adjustment of other controls may result in damage and will often require extensive work by a qualified technician to restore the product to its normal operation.
 - e. If the product has been dropped or cabinet has been damaged.
 - f. When the product exhibits a distinct change in performance this indicates need for service.
 16. Replacement Parts-When replacement parts are required, be sure the service technician has used replacement parts specified by the manufacturer or have the same characteristics as the original parts. Unauthorized substitutions may result in fire, electric shock or other hazards.
 17. Safety Check-Upon completion of any service or repairs to product, ask the service technician to perform safety checks to determine that the product is in proper operating condition.
 18. Carts and Stands-The appliance should be used only with a cart stand that is recommended by manufacturer.
 19. An appliance and cart combination should be moved with care. Quick stops, excessive force, and uneven surfaces may cause the appliance and cart combination to overturn.



FEATURES

- 60mm long faders are provided for 3 program channels. More sensitive control can be achieved for Techno/Trance mixing.
- Effect send switch is equipped on each input channel for effect performance. The effect send and return level controls are provided in the master section.
- P.F.L. (pre fader listen) switch is provided for pre fader monitoring.
- The input levels are monitored by over load indicator.
- Four mic input levels are provided. The main mic can be assigned to program channel 2 for full control. The other three mics are mixed with individual level control, 2 band EQ, effect send and P.F.L.
- Ten segment LED level meter is provided for careful level check.
- A powerful 3 band EQ with +6/-24dB range is provided along with the instant out switch on each band. More sensitive and drastic control can be achieved for Techno/Trance mixing.
- The new PCV-175 features removable flat panel that covers all screws etc., that will impede fast mixing. The panel is removed for crossfader and input faders replacement.
- New superior grade crossfader (CF-PCV) fitted to PCV-175 enabling super smooth operation together with long life.

FUNCTIONS

MIC INPUT SECTION

PROGRAM INPUT SECTION

MASTER SECTION

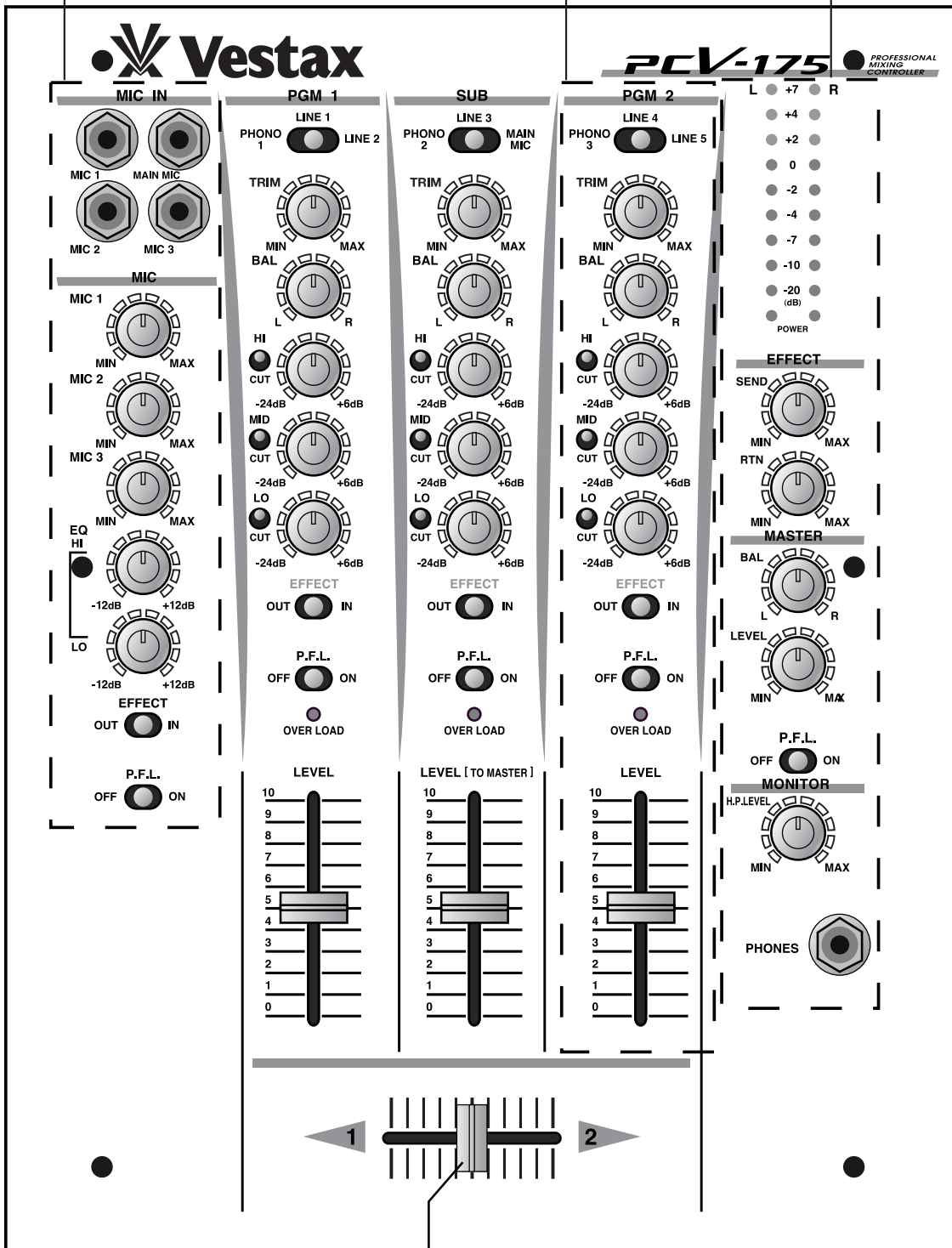

12

PROGRAM INPUT SECTION

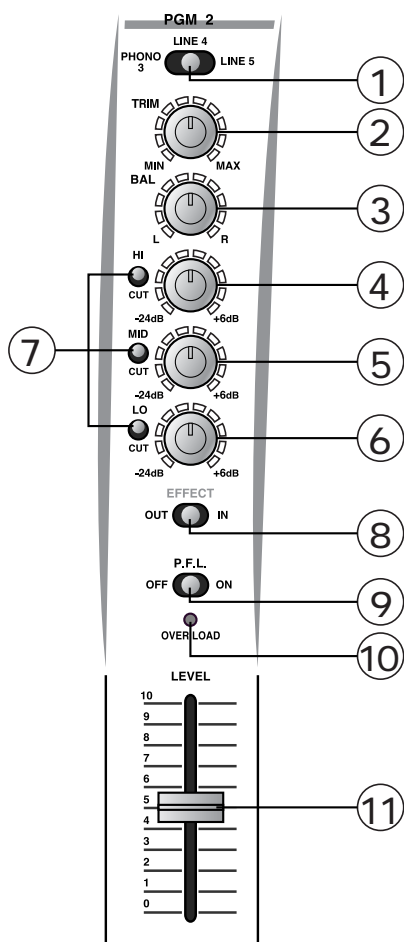

① INPUT SELECTOR

Used to select input (2 line or 1 phono) to be sent to each PGM channel.

② TRIM CONTROL

Adjusts the input level of each channel. Set INPUT FADER to 7-8 position, adjust the TRIM CONTROL so that the sufficient signal is fed without distortion.

③ BALANCE CONTROL

Adjusts the stereo balance for each PGM channel. Can be used for adjusting the unbalanced stereo image. Clockwise rotation from center position increases the volume of R over L channel. A counter clockwise rotation increases the volume of L channel over R.

④ EQUALIZER (HI 10Hz +6dB~-24dB)

Adjusts the HI frequency level of each PGM channel.

⑤ EQUALIZER (MID 1KHz +6dB~-24dB)

Adjusts the MID frequency level of each PGM channel.

⑥ EQUALIZER (LOW 80Hz +6dB~-24dB)

Adjusts the LOW frequency level for each PGM channel.

⑦ EQ CUT SWITCH (HI, MID, LOW)

Cuts off the each frequency range by 24dB. The EQUALIZER volume dose not function when this switch is set to "CUT".

⑧ EFFECT SWITCH

Used to send the signal to the external effect processor connected to the effect SEND/RETURN.

⑨ P.F.L. SWITCH

Used to send the signal from the PGM channel to the monitor section for headphone monitoring.

⑩ OVERLOAD INDICATOR

Lights when input level is over.

⑪ INPUT FADER

This is a detachable fader for the ease of replacement. Replace with IF-175 when it is worn out.

⑫ CROSS FADER

When the input level of PGM1 and PGM2 are properly set, PGM1 will be heard with the cross fader set to the left side. PGM2 will be heard with the cross fader set to the right side. When the cross fader is set in the center, both programs will be heard. This is detachable fader for the ease of replacement with "CF-PCV" when it is worn out.

HOW TO CHANGE THE FADER UNIT

■ HOW TO REMOVE THE TOP PANEL

- ① Remove each fader knobs and 6 screws which fix the top panel.
- ② Remove the top panel.

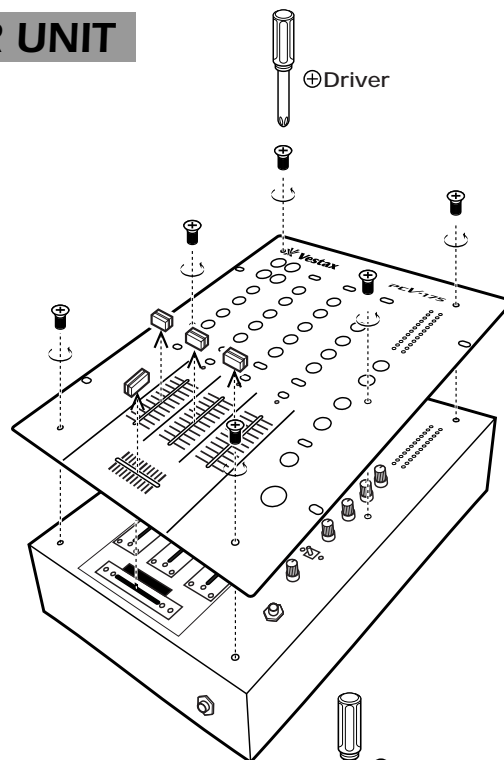

■ HOW TO CHANGE THE FADER UNIT

- ① Remove the screws on the fader panel.
- ② Remove the fader unit from position in mixer.
- ③ Carefully remove the multi-cable connector from fader unit.
- ④ Attach multi-cable connector to new fader unit.
- ⑤ Position the fader unit carefully and secure with screws.

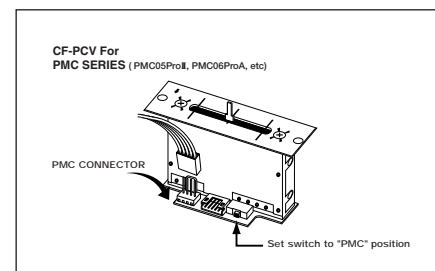
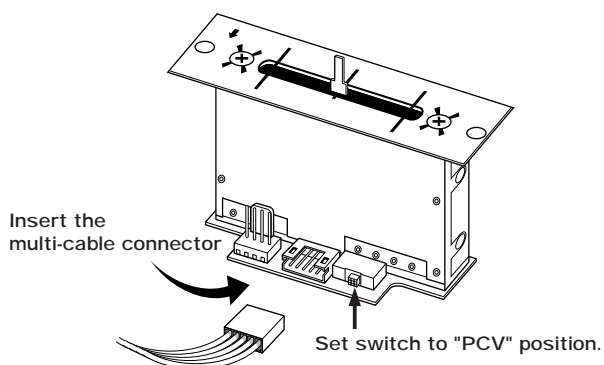
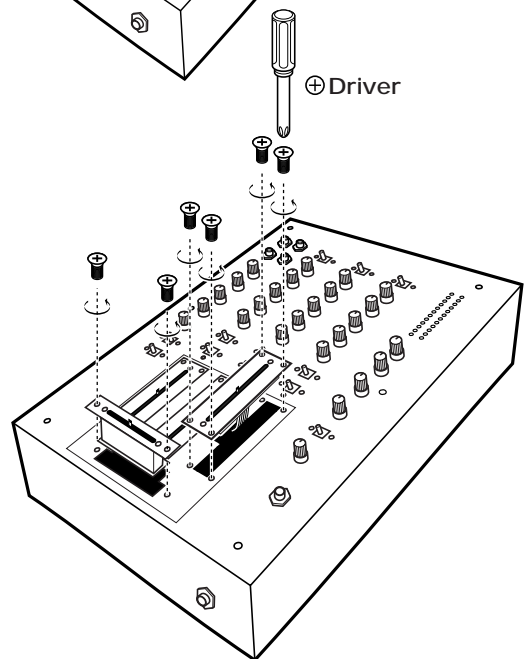

MIC INPUT SECTION

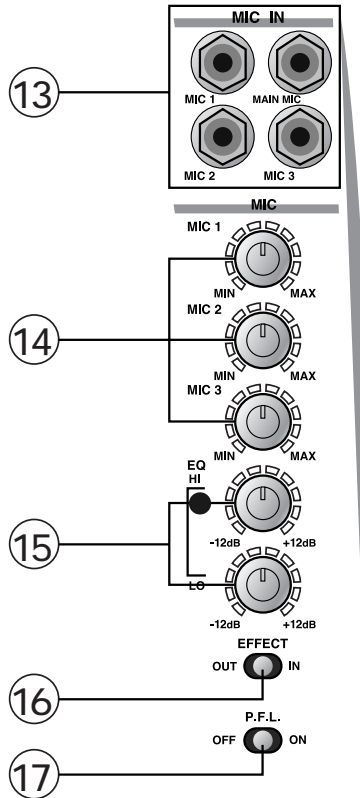

13 MIC INPUT JACK(MAIN MIC, MIC1~3)
Input jacks for MAIN MIC, MIC1, MIC2 and MIC3.

14 MIC LEVEL
Adjusts the input level of MIC1, 2 and 3.

15 MIC EQUALIZER(HI,LOW)
Adjusts the HI and LOW frequency level of MIC1, 2 and 3.

16 EFFECT SWITCH
Used to send the signal to the external effect processor connected to the effect SEND/RETURN.

17 P.F.L. SWITCH
Used to send the signal from the mic channel to the monitor section for headphone monitoring.

MASTER SECTION

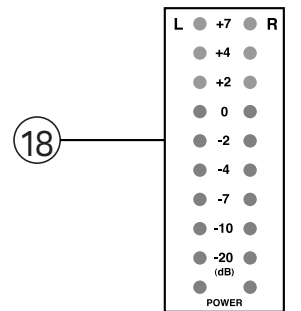

18 MASTER OUT LEVEL METER
Indicate the signal level of the line output. The lowest segment lights when the power is on.

19 EFFECT SEND LEVEL
Used to adjust the output level from EFFECT SEND JACK.

20 EFFECT RETURN LEVEL
Used to adjust the input level from EFFECT RETURN JACK.

21 MASTER BALANCE VOLUME
Adjust the signal balance between left and right of the master output.

22 MASTER LEVEL VOLUME
Adjust the signal level of the master output.

23 P.F.L. SWITCH
Used to send the master output signal to the monitor section for the headphone monitoring.

24 HEADPHONE LEVEL
Adjusts the headphone monitor level.

25 HEADPHONE JACK
Connect the headphones with the impedance of 8ohm to 600 ohm.

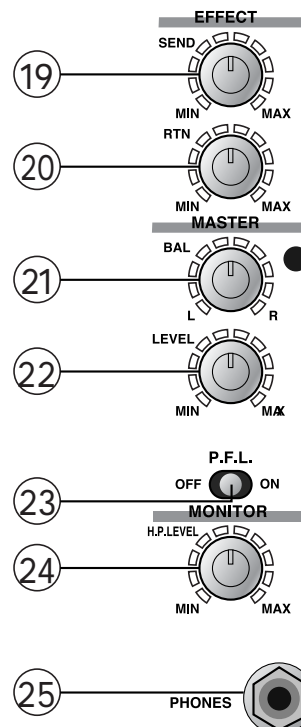

REAR PANEL SECTION

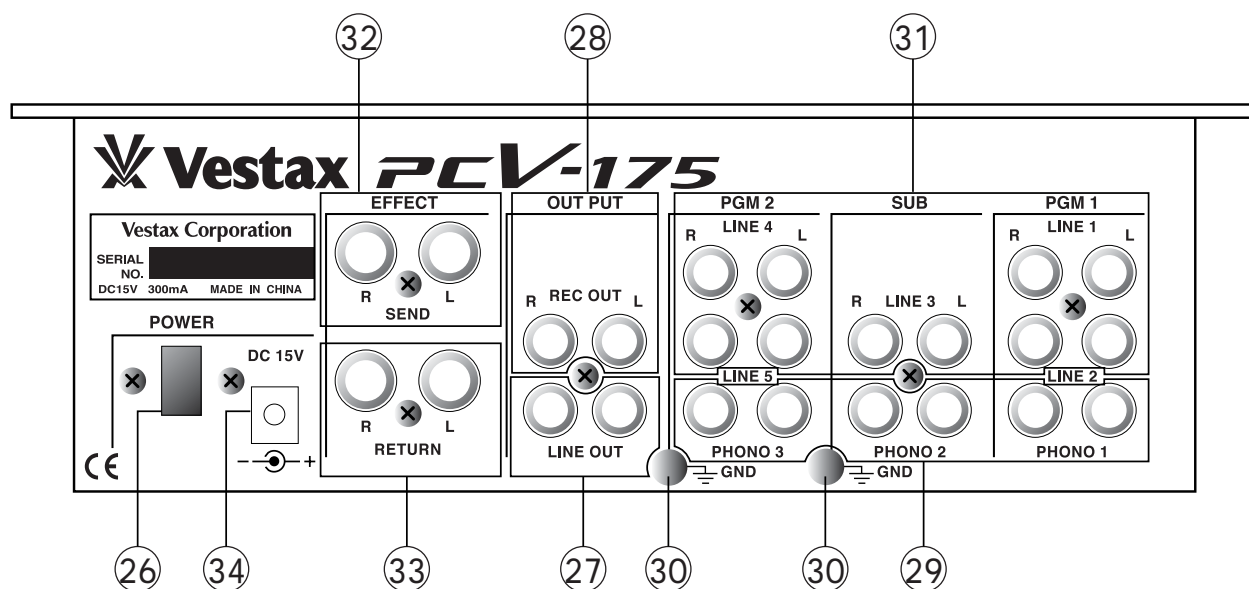

- ②6 **POWER SWITCH**
- ②7 **LINE OUTPUT JACK**
Connect to the power amplifier.
- ②8 **REC OUT JACK (RCA PIN JACK)**
Connect to the input jack of the tape recorder, MD, DAT, etc. The output level of this jack is fixed and does not change with the master volume level volume.
- ②9 **PHONO INPUT JACK**
Input jack for the turntable with MM (Moving Magnet) type cartridge.
- ③0 **GROUND TERMINAL**
Connect this terminal to the ground lead of the turntable.
- ③1 **LINE INPUT JACK**
Input jack for the line level equipment such as CD PLAYER, TAPE DECK, DAT, MD, etc.
- ③2 **EFFECT SEND JACK**
Connect to the input of the external effects. (Delay, Reverb etc)
- ③3 **EFFECT RETURN JACK**
Connect to the output of the external effects.
- ③4 **AC POWER JACK**
Connect the external power supply (DC-15A). Connecting wrong power supply may cause severe damage to the unit.

CONNECTIONS

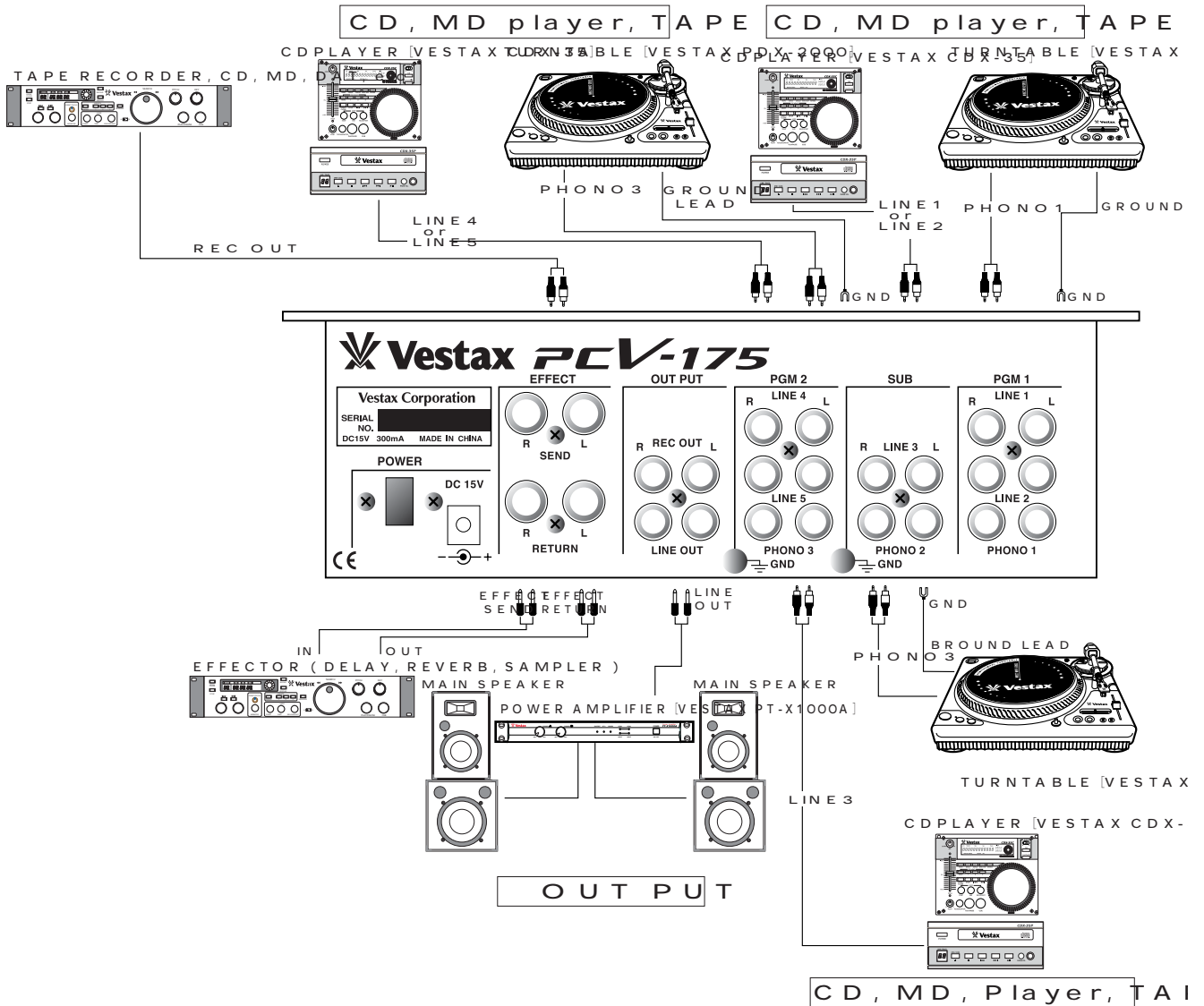

SPECIFICATIONS

		NOMINAL INPUT LEVEL	MAXIMUM INPUT LEVEL	INPEDANCE
INPUT SECTION	MIC (1/4 PHONE JACK)	-50dBv	-20dBv	3.3kΩ
	PHONO 1~3L/R (RCA JACK)	-42dBv	-22dB v	470kΩ
	LINE 1~5L/R (RCA JACK)	-10dBv	+14dBv	47kΩ
EQUALIZER SECTION	HI	10KHz +6dB ~-24dB		
	MID	1KHz +6dB ~-24dB		
	LOW	80KHz +6dB ~-24dB		
OUTPUT SECTION		RATED OUTPUT	MAXIMUM OUTPUT	INPEDANCE
	LINE L/R (RCA JACK)	-4dBv	+10dBv	10kΩ OVER
	REC OUT L/R (RCA JACK)	-10dBv	+10dBv	10kΩ OVER
	EFFECT SEND (1/4' PHONE JACK)	-10dBv	+14dBv	10kΩ OVER
	HEAD PHONE (1/4' PHONE JACK)		130mW	8Ω OVER/47Ω
FREQUENCY RESPONSE	MIC	30Hz ~ 20kHz ±3dB	CROSSFADER CROSSTALK	> 75dB
	LINE	20Hz ~ 20kHz ±1dB	CHANNEL CROSSTALK	> 65dB
S/N RATIO	MIC	>60dB	POWER SUPPLY	DC15V ADAPTOR
	LINE	>85dB	DIMENSIONS (W×H×D)	270×89×353
		WEIGHT		4kg



Vestax Corporation

MAY.2001 PCV175 E2



Vestax Corporation 1-18-6 Wakabayashi, Setagaya-ku, Tokyo 154-0023 Japan
Telephone : 81-(0)3-3412-7011 Fax : 81-(0)3-3412-7013. www.vestax.jp

**This is to certify that the product subsequently referred to
was designed and manufactured in conformity with the
following EC directives;
89/336/EEC (EMC)
73/23/EEC (LVD)**

Model type : Professional Mixing Controller

Model Description : Professional DJ Mixer / PCV series

Model Number : PCV-175

Applicable Standards : EN55013:1990+A12:1994+A13:1996 Limits and methods of measurement of radio disturbance characteristics of broadcast receivers and associated equipment (including amendments A12:1994 and A13:1996) (CISPR13:1975/Amdt1:1983, modified)
EN50082-1:1997 Electromagnetic compatibility-Generic immunity standard Part1:Residential, commercial and light industry

Date : Wednesday, December 19, 2001

Place of Issue : Vestax Corporation, 1-18-6 Wakabayashi, Setagaya-ku,
Tokyo 154-0023 Japan

**Manufacturers Authorized
Signature :**

Function of Signatory :

Masaaki Shiomi

Director

Free Manuals Download Website

<http://myh66.com>

<http://usermanuals.us>

<http://www.somanuals.com>

<http://www.4manuals.cc>

<http://www.manual-lib.com>

<http://www.404manual.com>

<http://www.luxmanual.com>

<http://aubethermostatmanual.com>

Golf course search by state

<http://golfingnear.com>

Email search by domain

<http://emailbydomain.com>

Auto manuals search

<http://auto.somanuals.com>

TV manuals search

<http://tv.somanuals.com>