

 **Vestax**
Professional Mixing Controller
PMG-55
OWNER'S MANUAL

VESTAX CORPORATION
2-37-1 Kamitama, Setagaya-ku, Tokyo 154-0011 Japan
Phone 03-3412-7011 Fax 03-3412-7013

VESTAX America
2750C 29th Ave Suite 115 Hollywood, FL 33020
Phone 303-766-5269 Fax 303-766-2196

VESTAX (Europe) Ltd.
18 St Christophers Road, Haslemere, Surrey GU 27 1DQ England.
Phone 01428-653117 Fax 01428-661021

CONGRATULATIONS!

Thank you for purchasing the VESTAX PMC-55, Professional Mixing Controller. Please read this owner's manual carefully before you start to use your mixer, so that you will fully understand all of the special features and enjoy the full use of the product.

CONTENTS

C A U T I O N	1
IMPORTANT SAFEGUARD	2
F E A T U R E S	3
CONTROL AND FUNCTIONS	4
PROGRAM INPUT SECTION	5
CROSSFADER SECTION	6
MICROPHONE SECTION	6
MASTER SECTION	7
MONITOR SECTION	8
FRONT PANEL SECTION	8
REAR PANEL SECTION	9
BLOCK DIAGRAM	10
C O N N E C T I O N	11
BOOST CANCEL SW/ TRIM LEVEL SELECT SW	12
M E M O	13
SPECIFICATIONS	14



CAUTION

RISK OF ELECTRIC SHOCK DO NOT OPEN



**CAUTION : TO REDUCE THE RISK OF ELECTRIC SHOCK
DO NOT REMOVE COVER (OR BACK)
NO USER-SERVICEABLE PARTS INSIDE
REFER SERVICING TO QUALIFIED SERVICE PERSONNEL**



The lightning flash with arrowhead symbol, within an equilateral triangle, is intended to alert the user to the presence of uninsulated "dangerous voltage" within the product's enclosure that may be of sufficient magnitude to constitute a risk of electric shock to persons.



The exclamation point within an equilateral triangle is intended to alert the user to the presence of important operating and maintenance (servicing) instructions in the literature accompanying the appliance.

TO REDUCE THE RISK OF FIRE OR ELECTRIC SHOCK, DO NOT EXPOSE THIS APPLIANCE TO RAIN OR MOISTURE.

IMPORTANT SAFEGUARDS

READ BEFORE OPERATING EQUIPMENT

This product was designed and manufactured to meet strict quality and safety standards. There are, however, some installation and operation precautions which you should be particularly aware of.

1. Read instructions-All the safety and operating instructions should be read before the appliance is operated.
2. Retain instructions-The safety and operating instructions should be retained for future reference.
3. Heed Warnings-All warnings on the appliance and in the operating instructions should be adhered to.
4. Follow Instructions-All operating and use instructions should be followed.
5. Cleaning-Do not use liquid cleaners or aerosol cleaners. Use a damp cloth for cleaning.
6. Attachments-Do not use attachments not recommended by the product manufacturer as they may cause hazards.
7. Water and Moisture-Do not use this product near water-for example, near a bath tub, wash bowl, kitchen sink, or laundry tub, in a wet basement, or near a swimming pool, and the like.
8. Accessories-Do not place this product on an unstable cart, stand, tripod, or table. The product may fall, causing serious injury to a child or adult, and serious damage to the appliance. Use only with a cart, stand, tripod, bracket, or table recommended by the manufacturer, or sold with product. Any mounting of the appliance should follow the manufacturer's instructions, and should use a mounting accessory recommended by the manufacturer.
9. This product should never be placed near or over a radiator or heat register. This product should not be placed in a built-in installation such as a bookcase or rack unless proper ventilation is provided or the manufacturer's instructions have been adhered to.
10. Power sources-This product should be operated only from the type of power source indicated on the marking label. If you are not sure of the type of power supply to your home, consult your appliance dealer or local power company.
11. Lightning-For added protection for this product during lightning storm, or when it is left unattended and unused for long periods of time, unplug it from the wall outlet. This will prevent damage to the product due to lightning and power-line surges.
12. Overloading-Do not overload wall outlets and extension cords as this can result in a risk of fire or electric shock.
13. Object and Liquid Entry-Never push objects of any kind into this product through openings as they may touch dangerous voltage points or short-out parts that could result in a fire or electric shock. Never spill liquid of any kind on the product.
14. Servicing-Do not attempt to service product yourself as opening or removing covers may expose you to dangerous voltage or other hazards. Refer all servicing to qualified personnel.

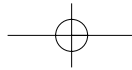

15. Damage Requiring Service-Unplug this product from the wall outlet and refer servicing to qualified service personnel under the following conditions:
 - a. When the power-supply cord or plug is damaged.
 - b. If liquid has been spilled or objects have fallen into the product.
 - c. If the product has been exposed to rain or water.
 - d. If the product does not operate normally by following the operating instructions. Adjust only those controls that are covered by the operating instructions as an improper adjustment of other controls may result in damage and will often require extensive work by a qualified technician to restore the product to its normal operation.
 - e. If the product has been dropped or cabinet has been damaged.
 - f. When the product exhibits a distinct change in performance-this indicates need for service.
16. Replacement Parts-When replacement parts are required, be sure the service technician has used replacement parts specified by the manufacturer or have the same characteristics as the original parts. Unauthorized substitutions may result in fire, electric shock or other hazards.
17. Safety Check-Upon completion of any service or repairs to product, ask the service technician to perform safety checks to determine that the product is in proper operating condition.
18. Carts and Stands-The appliance should be used only with a cart stand that is recommended by manufacturer.
19. An appliance and cart combination should be moved with care. Quick stops, excessive force, and uneven surfaces may cause the appliance and cart combination to overturn.



FEATURES

1. A high specification VCA, Voltage Controlled Amplifier, is utilized in the Crossfader system. This minimizes noise and wear from the mechanical parts of the Crossfader. Additionally, the Crossfader "Curve" can be easily adjusted on the front panel for change in Mixing styles. At one extreme is the long running mix and at the other is the Scratch or Cut mix.
2. Each of the input channels will accept one stereo phono and two stereo line sources, these are instantly switchable giving a massive twelve input capability. Each input channel has a gain control for the setting of input levels. A level display, balance control and three band EQ are also provided on each channel. The separate Mic input section has its own EQ.
3. One stereo input of each channel can be connected via the top panel for quick and easy access. This is particularly useful for "visiting" DAT players, etc.
4. The stereo Insertion ports are provided on the front panel. These allow for the easy connection of outboard effects such as VESTAX DCR-1200PRO Frequency Separator, Compressor and Gate machines. And the stereo Master loop is provided on the top panel also. This allows for total sound control with Graphic EQ or Reverberator, etc.
5. The PMC-55 has the most comprehensive output lineup as well. No less than two separate Masters (balanced and unbalanced), one DJ Booth Monitor, one stereo Cue and a Headphones Monitor makes this mixer the most versatile "MIXER'S MIXER" available today.

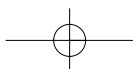

CONTROL AND FUNCTIONS

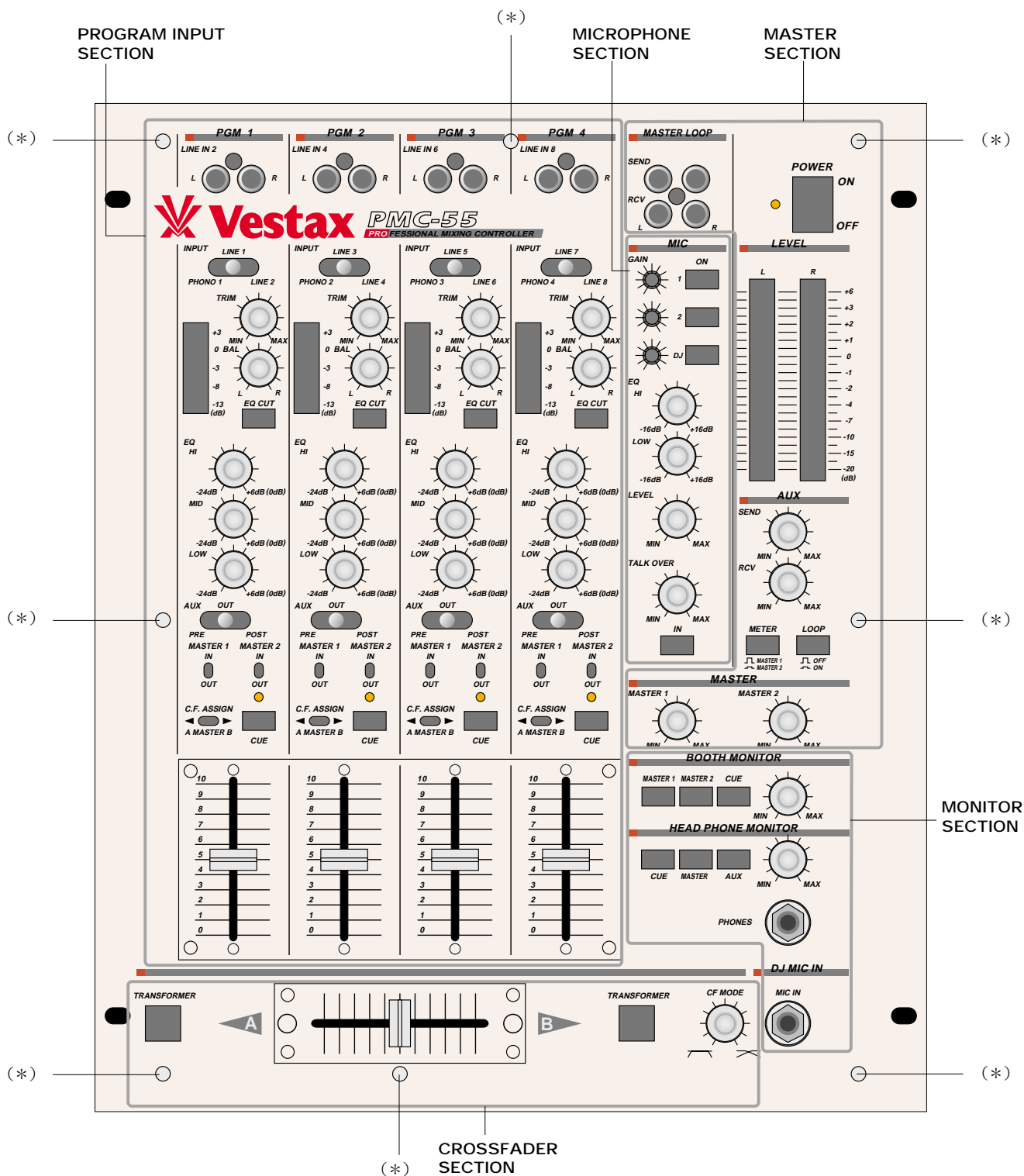

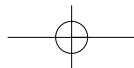

PROGRAM INPUT SECTION

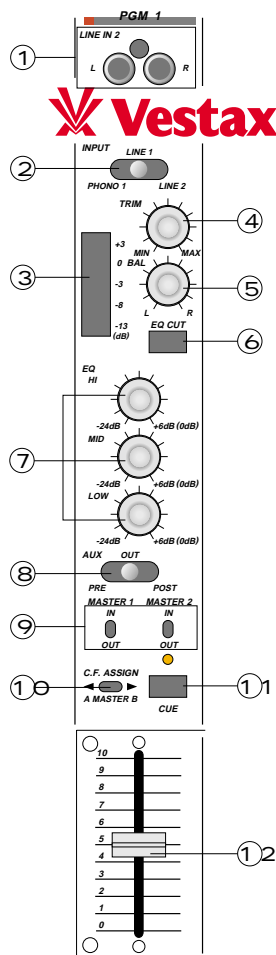

① LINE IN 2, 4, 6, 8 (RCA)

Used for line level input. Connect CD player or tape deck to these jacks. Line level musical instruments with stereo outputs such as rhythm machine or sampler are also good for LINE IN. And they are located on the top panel for quick and easy access. This is particularly useful for "visiting" equipment.

② INPUT SELECTOR

Used to select the input (two LINE or one PHONO) to be sent to each PGM channel.

③ INPUT LEVEL METER

The LED level meters indicate the input signal level of each PGM channel.

④ GAIN CONTROL

Adjusts the input level of each channel. Set INPUT FADER (12) to 7-8 position, adjust GAIN so that INPUT LEVEL METER(3) shows about 0dB.

⑤ BALANCE CONTROL

Adjusts the stereo balance for each PGM channel. Can be used for adjusting the unbalanced stereo image caused by strong Anti-Skating setting. Clockwise rotation from center position increase volume of R over L channel. Counter clockwise rotation increase volume of L channel over R.

⑥ EQ CUT SWITCH

Press this switch to bypass EQ section.

⑦ EQ (HI, MID, LOW)

Adjusts the HI, MID and LOW frequencies for each PGM channel. Each band has following specifications.

HI	8kHz	-24dB~+6dB	Shelving type
MID	500Hz	-24dB~+6dB	Peaking type
LOW	80Hz	-24dB~+6dB	Shelving type

⑧ AUX ASSIGN SWITCH

Used when sending signal to external effect processor connected to AUX SEND/RETURN (42).

⑨ MASTER OUT ASSIGN 1, 2

Used to send the signal from each program to either MASTER OUT 1 or 2 (43). MASTER LOOP is located on MASTER OUT 1.

⑩ CROSSFADER ASSIGN

Used to send the signal from each program to either the crossfader (A or B) or the master directory. A for left side of the crossfader, B for right side.

⑪ CUE ASSIGN

Used to send the signal from each program to monitor section for headphones monitoring. Signal is sent to CUE OUT (42) too. This allows for sending signal to external sampling unit connected to CUE OUT.

⑫ INPUT FADER

Used to adjust the Input level of each program. Usually set at the 7-8 position. This is a detachable fader for the ease of replacement. Replace with IF-50 when It is worn out.

HOW TO REPLACE THE INPUT FADER

- Remove four screws which hold the fader unit panel.
- Take the unit out with the panel
- Remove a knob and two screws which hold the fader unit.
- Carefully remove the multi-cable connector from the fader unit.
- Insert the connector to the new fader unit.
- Replace the knob and the fader unit to the panel and fix it with screws.
- Replace the fader unit panel and tighten the screws.

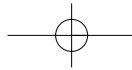

CROSSFADER SECTION

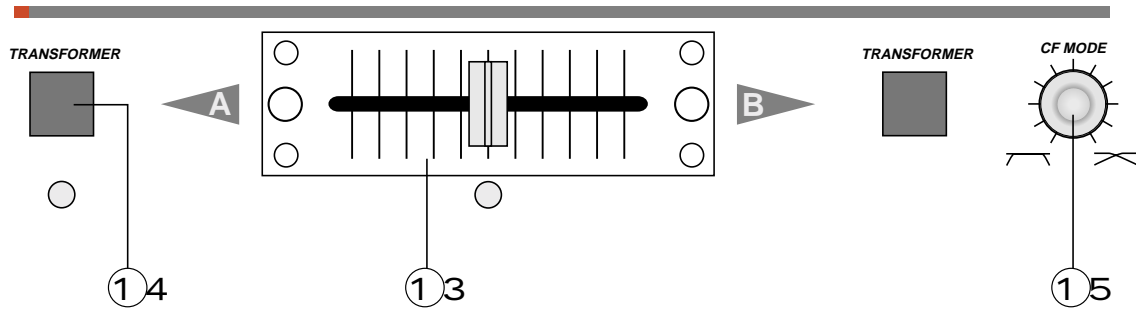

13 CROSS FADER

Mixes the signal assigns by CROSSFADER ASSIGN(10) to A side of the crossfader and B side. When the crossfader is set in the center position, both A and B can be heard. This is a detachable fader for ease of replacement with CF-50 when it is worn out.

HOW TO REPLACE THE CROSS FADER

- Remove a knob and four screws which hold the fader unit.
- Take the unit out.
- Carefully remove the multi-cable connector from the fader unit.
- Insert the connector to the new fader unit.
- Replace the knob and the fader unit and fix it with screws.

MICROPHONE SECTION

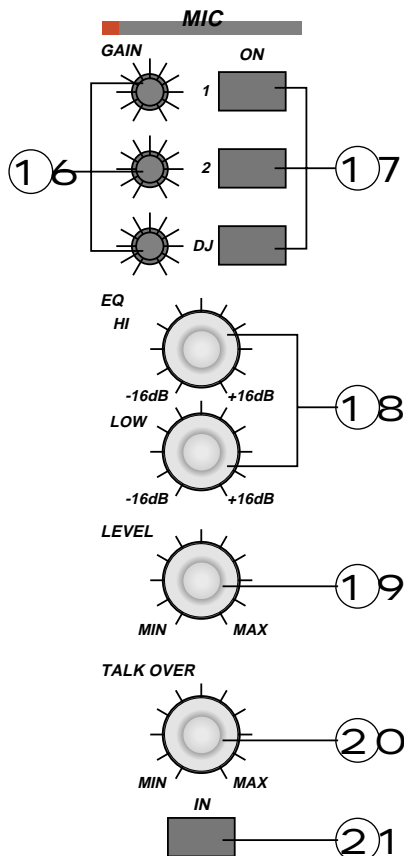

14 TRANSFORMER SWITCH

With the crossfader moved to either right or left, the opposite program can be heard instantly by pressing the opposite²⁰ transformer button.

15 CF MODE VOLUME

Adjust the crossfader curve. Clockwise rotation give a gentle crossfade good for long running mixes. Counter clockwise rotation gives a steep crossfade good for scratching and cutting.

16 MIC GAIN

Adjusts the input level from each microphone input.

17 MIC SELECTOR

Used to select the microphones to be Master section.

18 MIC EQ (HI,LOW)

Adjusts the HI and LOW frequencies for all microphones input.

19 MIC LEVEL

Adjusts the input level from all microphones input.

20 TALK OVER LEVEL

When TALK OVER SWITCH²¹ is depressed, the level of all sources excluding the microphone input are reduced. Reduction level can be adjusted by this control. Clockwise rotation gives a large reduction level.

21 TALK OVER SWITCH

When this switch is depressed, the level of all sources excluding the microphone input are reduced.

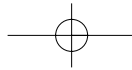

MASTER SECTION

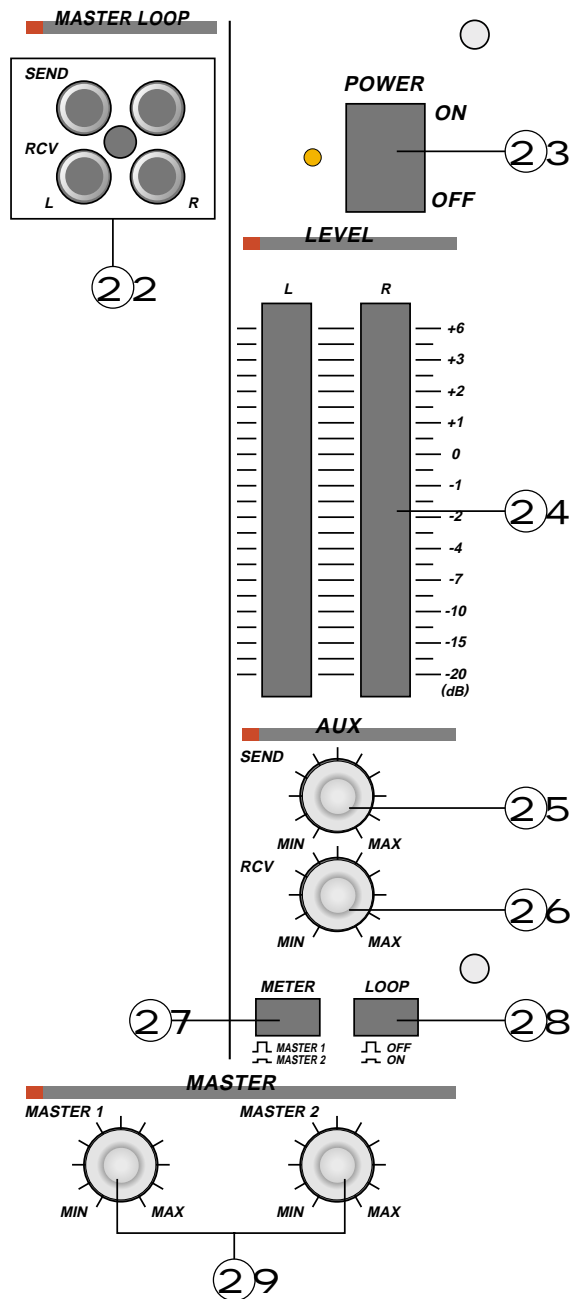

22 MASTER LOOP (RCA)

This loop(send/return) is located on MASTER OUT 1 (43) before output jack. It is useful for total sound control with Graphic EQ or Reverberator,etc.

23 POWER SWITCH

LED located on the top panel is lit when on.

24 OUTPUT LEVEL METER

The LED level meters indicate the signal level of MASTER OUT 1 or 2 (43).

25 AUX SEND LEVEL

Used to adjust send level from AUX SEND (41). The signal is selected by AUX ASSIGN SWITCH (8).

26 AUX RETURN LEVEL

Used to adjust return level to AUX RETURN (41). This AUX RETURN can be used as the sub line input.

27 METER ASSIGN

Select either MASTER OUT 1 or 2 indicated by OUTPUT LEVEL METER (25).

28 LOOP SWITCH

Used when sending signal to external effect processor connected to MASTER LOOP (22).

29 MASTER OUT LEVEL 1, 2

Used to adjust the output level from MASTER OUT 1 and 2 (43).

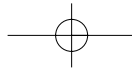

MONITOR SECTION

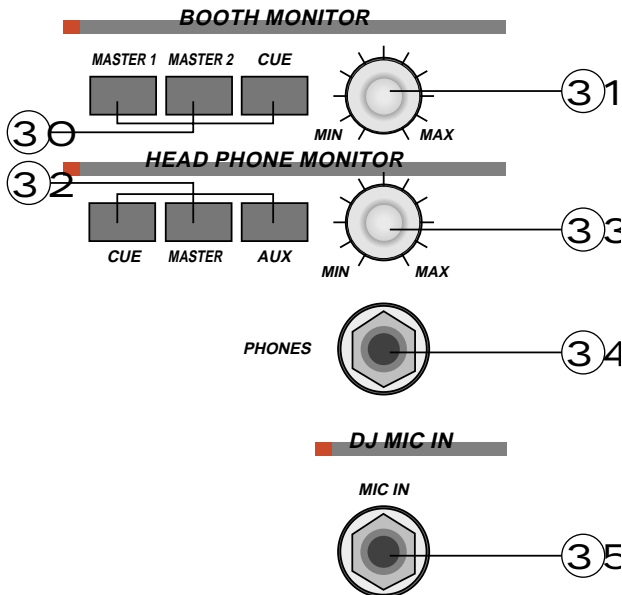

- ③① **BOOTH MONITOR SELECTOR**
Select either MASTER OUT 1,2 (43) or CUE ASSIGN (11) for monitoring by boothout.
- ③② **BOOTH MONITOR LEVEL**
Used to adjust the output level from BOOTH OUT (44).
- ③③ **HEADPHONES MONITOR SELECTOR**
Select either CUE OUT (42), MASTER OUT (43) or AUX SEND (41) for monitoring by headphones.
- ③④ **HEADPHONES LEVEL**
Adjusting the headphones output level.
- ③⑤ **HEADPHONES JACK**
When listening with stereo headphones, connect them to this jack. This features stereo cue system.
- ③⑥ **DJ MIC JACK**
Input jack for connecting a DJ microphone.

FRONT PANEL

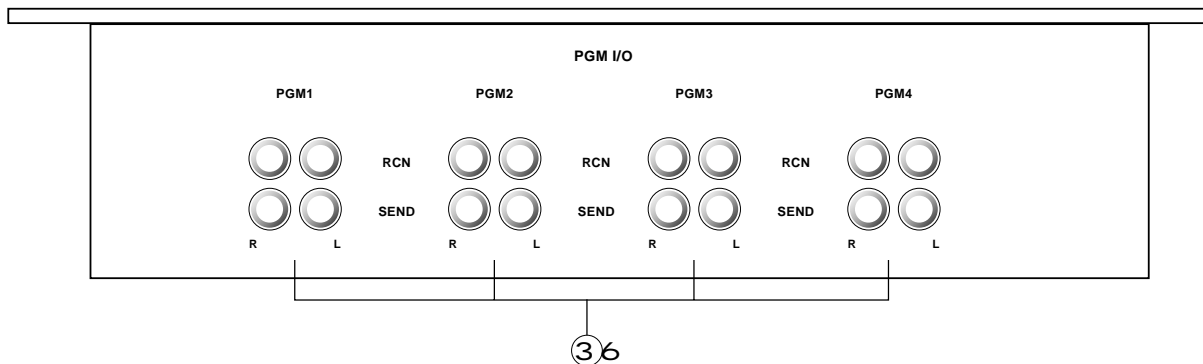

- ③⑥ **PROGRAM SEND/RETURN (RCA)**
They are stereo channel insertion ports allow for the easy connection of outboard effects.

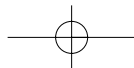

REAR PANEL

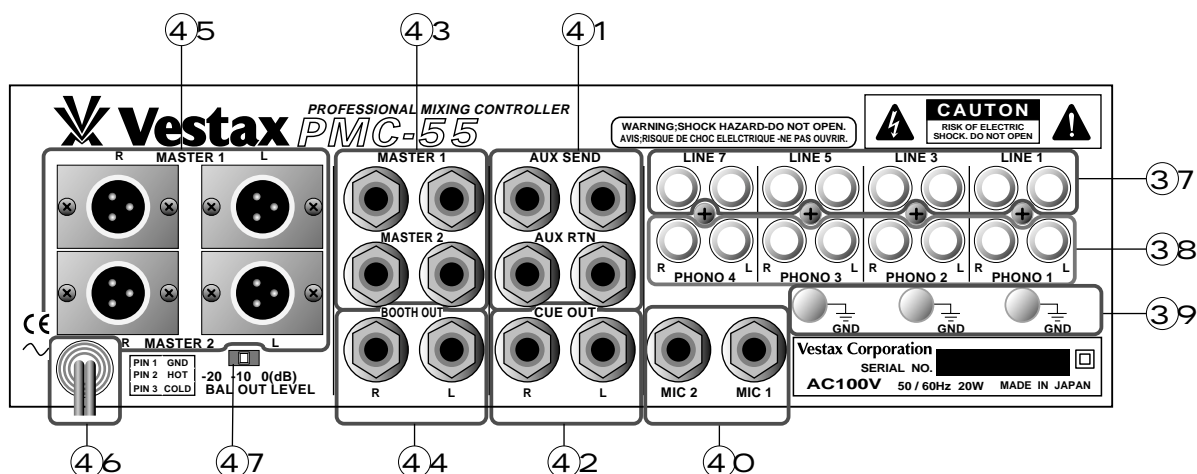

- ③⑦ **LINE IN 1, 3, 5, 7 (RCA)**
They work the same as LINE IN 2, 4, 6, 8 (1).
- ③⑧ **PHONO IN 1, 2, 3, 4 (RCA)**
Connects turntable output equipped with MM type pickup cartridge. If MC type cartridge is used, a pre-amp is required.
- ③⑨ **GROUND TERMINAL**
Connects to ground lead of the turntable. This helps to reduce noise and hum.
- ④⑩ **MIC 1, 2 (1/4" Phone)**
Input jack for connecting the microphones.
- ④① **AUX SEND/RETURN (1/4" Phone)**
Connects to outboard effects such as Delay machine. AUX SEND is located on pre-input fader.
- ④② **CUE OUT (1/4" Phone)**
When CUE ASSIGN(11) is depressed, the signal comes out from this jack. It can be used for sampling source output.
- ④③ **MASTER OUT 1, 2 (1/4" Phone, Unbalanced)**
Connects to the input of power amplifier. These jacks are Phone type for consumer applications. This mixer has two pairs of MASTER OUT. And each output level can be set separately. This means that MASTER OUT (43) can be used for main output and sub. For example, one for hall, the other for entrance.
- ④④ **BOOTH OUT (1/4" Phone)**
This can be used for DJ booth monitor. Same signal as HEADPHONES OUT comes out.
- ④⑤ **MASTER OUT 1, 2 (XLR, Balanced)**
Connects to the input of power amplifier. These connectors are XLR type for professional audio applications. They work the same as Unbalanced MASTER OUT 1, 2 (43). Pin No.3 for HOT.
- ④⑥ **AC POWER CABLE**
Connects the plug to AC outlet on the wall.
- ④⑦ **BALANCE OUT LEVEL SWITCH**
Used to select the output level of the MASTER OUT 1, 2.

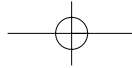

CONNECTION

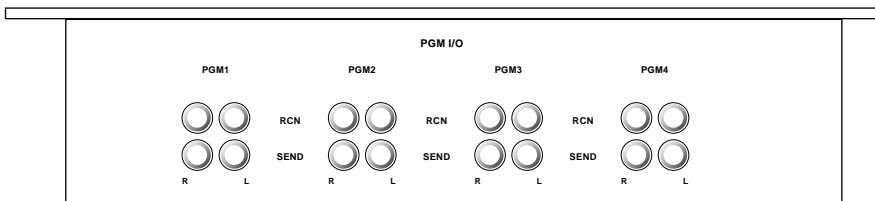
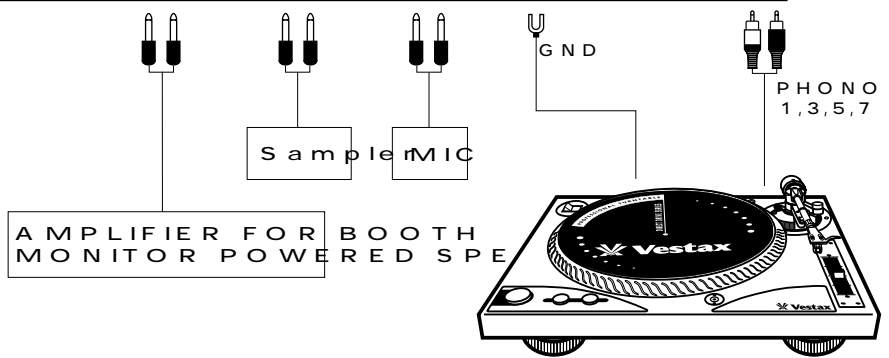
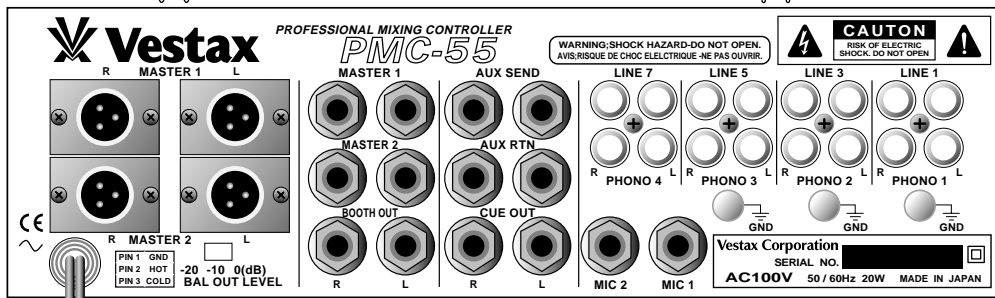
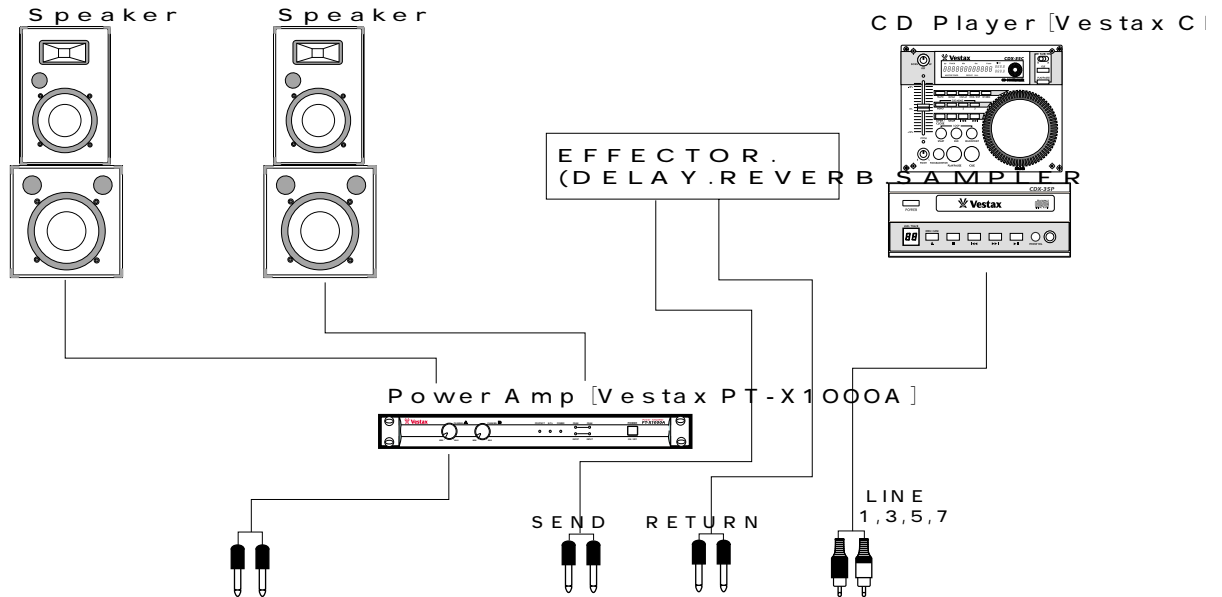

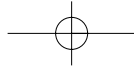

BOOST CANCEL SW/TRIM LEVEL SELECT SW

CAUTION

BOOST CANCEL SWITCH and TRIM LEVEL SELECT SWITCH are located under front panel. When you change settings, remove 8 screws (*) on front panel (refer to page 5, CONTROL AND FUNCTION) . And remove front panel.

BOOST CANCEL SWITCH

①

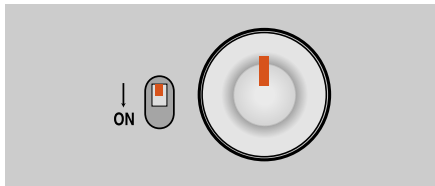

① Each EQ volume has boost cancel switch.

②



② When boost cancel switch is on, equalizer range changes - 24 ~ +6dB to - 24 ~ 0dB EQ boost is canceled.

TRIM LEVEL SELECT SWITCH

③



③ Each trim volume has level select switch. you can select range of trim from -20,-10,and 0dB.

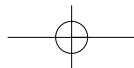

SPECIFICATIONS

	Normal Input Level/Impedance
PHONO	- 42dBv / 60kΩ
LINE	- 10dBv / 20kΩ
MIC	- 60dBv / 2kΩ
AUX RTN	- 10dBv / 10kΩ
MASTER LOOP RTN	- 10dBv / 10kΩ
PGM I/O RTN	-10dBv / 5kΩ
	Normal Output Level/Impedance
MASTER OUT (UNBAL.)	0dBv / 1kΩ
MASTER OUT (BAL.)	+4dBm / 200Ω
AUX SEND	-10dBv / 500Ω
CUT OUT	0dBv / 500Ω
BOOTH OUT	0dBv / 500Ω
HEADPHONES	80mW max. @ 33Ω / ≥8Ω
MASTER LOOP SEND	-10dBv / 1kΩ
PGM I/O SEND	-10dBv / 500Ω
Frequency Response	20Hz ~ 20kHz (+0, - 1dB)
S/N Ratio	≥120dB
THD	<0.01%
Dimensions (W×H×D)	330×90×400mm
Weight	7.0kg
Power Requirement	20W

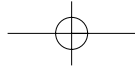

Vestax Corporation

Free Manuals Download Website

<http://myh66.com>

<http://usermanuals.us>

<http://www.somanuals.com>

<http://www.4manuals.cc>

<http://www.manual-lib.com>

<http://www.404manual.com>

<http://www.luxmanual.com>

<http://aubethermostatmanual.com>

Golf course search by state

<http://golfingnear.com>

Email search by domain

<http://emailbydomain.com>

Auto manuals search

<http://auto.somanuals.com>

TV manuals search

<http://tv.somanuals.com>