

## FCC STATEMENT

This device complies with Part 15 of the FCC Rules. Operation is subject to the following two conditions:

- (1) This device may not cause harmful interference, and
- (2) This device must accept any interference received, including interference that may cause undesired operation.

**Note:**

This equipment has been tested and found to comply with the limits for Class B digital devices, pursuant to Part 15 of the FCC rules. These limits are designed to provide reasonable protection against harmful interference in a residential installation. This equipment generates, uses and can radiate radio frequency energy and, if not installed and used in accordance with the instructions, may cause harmful interference to radio communications.

However, there is no guarantee that interference will not occur in a particular installation. If this equipment does cause harmful interference to radio or television reception, which can be determined by turning the equipment off and on, the user is encouraged to try to correct the interference by one or more of the following measures:

- Reorient or relocate the receiving antenna
- Increase the separation between the equipment and receiver
- Connect the equipment into an outlet on a circuit different from that to which the receiver is connected
- Consult the dealer or an experienced radio/TV technician for help

Use of shielded cable is required to comply with Class B limits in Subpart B of Part 15 of the FCC rules. Do not make any changes or modifications to the equipment unless otherwise specified in the manual. If such changes or modifications should be made, you could be required to stop operation of the equipment.

## TRADEMARK INFORMATION

- Microsoft® and Windows® are U.S. registered trademarks of Microsoft Corporation.
- Pentium® is a registered trademark of Intel Corporation.
- Macintosh is a trademark of Apple Computer, Inc.
- SD™ is a trademark.
- Other names and products may be trademarks or registered trademarks of their respective owners.

## READ THIS FIRST

### Notice:

1. Product design and specifications are subject to change without notice. This includes primary product specifications, software, software drivers, and user's manual. This User Manual is a general reference guide for the product.
2. The product and accessories that come with your ViviCam 3105s may be different from those described in this manual. This is due to the fact that different retailers often specify slightly different product inclusions and accessories to suit their market requirements, customer demographics, and geographical preferences. Products very often vary between retailers especially with accessories such as batteries, memory cards, cables, pouches, and language support. Occasionally a retailer will specify a unique product color, appearance, and internal memory capacity. Contact your dealer for precise product definition and included accessories.
3. The illustrations in this manual are for the purpose of explanation and may differ from the actual design of your ViviCam 3105s.
4. The manufacturer assumes no liability for any errors or discrepancies in this user manual.

## SAFETY INSTRUCTIONS

Read and understand all **Warnings** and **Cautions** before using this product.

### Warning

**If foreign objects or water have entered the ViviCam 3105s, turn the power OFF and remove the batteries.**

Continued use in this state might cause fire or electric shock. Consult the store of purchase.



**If the ViviCam 3105s has fallen or its case has been damaged, turn the power OFF and remove the batteries.**

Continued use in this state might cause fire or electric shock. Consult the store of purchase.



**Do not disassemble, change or repair the ViviCam 3105s.**

This might cause fire or electric shock. For repair or internal inspection, ask the store of purchase.



**Use the specified batteries.**

Use with any other type of batteries might cause explosion or influence the ViviCam 3105s' performance.



**Do not use the ViviCam 3105s in areas near water.**

This might cause fire or electric shock. Take special care during rain, snow, on the beach, or near the shore.



**Do not place the ViviCam 3105s on inclined or unstable surfaces.**

This might cause the ViviCam 3105s to fall or tilt over, causing injury.



**Keep the batteries out of the reach of children.**

Swallowing batteries might cause poisoning. If the batteries are accidentally swallowed, immediately consult a physician.



**Do not use the ViviCam 3105s while you are walking, driving or riding a vehicle.**

This might cause you to fall over or result in traffic accident.



**WARNING:** Handling the USB cable on this product may expose you to lead, a chemical known to the State of California to cause birth defects or other reproductive harm. **Wash hands after handling.**

**Caution****Load the batteries paying careful attention to the polarity (+ or -).**

Load the batteries with their polarities inverted might cause fire and injury, or damage to the surrounding areas due to the battery rupturing or leaking.

**Do not fire the flash close to anyone's eyes.**

This might cause damage to the person's eyesight.

**Do not subject the LCD monitor to impact.**

This might damage the glass on the screen or cause the internal fluid to leak. If the internal fluid enters your eyes or comes into contact with your body or clothes, rinse with fresh water. If the internal fluid has entered your eyes, consult a physician to receive treatment.

**ViviCam 3105s is a precision instrument. Do not drop it, strike it or use excessive force when handling the ViviCam 3105s.**

This might cause damage to the ViviCam 3105s.

**Do not use the ViviCam 3105s in humid, steamy, smoky, or dusty places.**

This might cause fire or electric shock.

**Do not remove the batteries immediately after long period of continuous use.**

The batteries become hot during use. Touching hot batteries might cause burns.

**Do not wrap the ViviCam 3105s or place it in cloth or blankets.**

This might cause heat to build up and deform the case, resulting in fire. Use the ViviCam 3105s in a well-ventilated place.

**Do not leave the ViviCam 3105s in places where the temperature may rise significantly, such as inside a car.**

This might adversely affect the case or the parts inside, resulting in fire.

**Before you move the ViviCam 3105s, disconnect cords and cables.**

Failure to do this might damage cords and cables, resulting in fire and electric shock.



## Notes on Batteries Usage

When you use the batteries, carefully read and strictly observe the **Safety Instructions** and the notes described below:

- Use only the specified batteries.
- Avoid using the batteries in extremely cold environments as low temperatures can shorten the batteries life and reduce ViviCam 3105s performance. This low temperature will also influence Alkaline batteries performance, therefore Ni-MH rechargeable batteries are highly recommended.
- When you are using the new rechargeable batteries or rechargeable batteries that has not been used for an extended period of time (the batteries that passed the expiry date are exception) might affect the number of images that can be captured. Therefore, to maximize their performance and lifetime, we recommend that you fully charge the batteries and discharge them for at least one complete cycle before use.
- The batteries may feel warm after long period of continuous use of the ViviCam 3105s or the flash. This is normal and not a malfunction.
- The ViviCam 3105s may feel warm after long period of continuous use. This is normal and not a malfunction.
- If the batteries are not to be used for a long period of time, remove it from the ViviCam 3105s to prevent leakage or corrosion.
- If the batteries are not to be used for a long period of time, store them after no batteries power left. If the batteries are stored for a long time in a fully charged state, their performance may be impaired.
- Risk of explosion if batteries are replaced by an incorrect type.
- Dispose of used batteries according to the instructions.
- Never use batteries of different types (together) or mix old and new batteries.
- Never use manganese batteries.

# CONTENTS

## 8 INTRODUCTION

- 8 Overview
- 9 Package Contents

## 10 GETTING TO KNOW YOUR VIVICAM 3105S

- 10 Front View
- 11 Rear View
- 12 LED Indicator & Beep
- 13 LCD Monitor Icons

## 15 GETTING STARTED

- 15 Attaching the ViviCam 3105s Strap
- 15 Loading the Batteries (Optional Accessory)
- 16 Inserting and Removing the SD Memory Card (Optional Accessory)
- 17 Turning the Power On/Off
- 18 Choosing the Language
- 18 Formatting the SD Memory Card or Internal Memory
- 19 Setting Image Resolution and Quality

## 21 CAPTURE MODE

- 21 Normal Mode
- 22 Macro Mode
- 22 Digital Zoom
- 23 Flash
- 24 Shooting Mode

## 25 Video Mode

- 25 Recording Video Clips

## 26 PLAYBACK MODE

- 26 Playing Back Still Images
- 26 Playing Back Video Clips
- 27 Slideshow Display
- 27 Protecting Images
- 28 Thumbnail Display
- 28 Rotating the Image

## 29 Deleting Images

- 29 Deleting single image / Deleting all images

## 30 MENU OPTIONS

- 30 Capture Menu

- 31 Video Menu
- 31 Playback Menu
- 32 Setup Menu
- 33 TRANSFERRING RECORDED IMAGES AND VIDEOS TO YOUR COMPUTER**
  - 33 Step 1: Installing the USB Driver
  - 34 Step 2: Connecting the ViviCam 3105s to Your Computer
  - 35 Step 3: Downloading Images and Video Files
- 36 USING THE DIGITAL STILL VIVICAM 3105S AS A PC VIVICAM 3105S**
  - 36 Step 1: Installing the PC camera driver
  - 37 Step 2: Connecting the ViviCam 3105s to your computer
  - 37 Step 3: Running your application software (i.e. Yahoo Messenger)
- 38 EDITING SOFTWARE INSTALLATION**
  - 38 Installing Photo Explorer
  - 39 Installing Photo Express
- 40 INSTALLING ACROBAT READER**
- 41 USER'S MANUAL ON CD-ROM**
- 42 VIVICAM 3105S SPECIFICATIONS**
- 43 TROUBLESHOOTING**

# INTRODUCTION

## Overview

Congratulations on your purchase of the new ViviCam 3105s.

The main features provided by the ViviCam 3105s include the following:

---

**LCD monitor –** 1.5" color TFT LCD (228 x 220 pixels) monitor makes it easy to frame your subject when capturing images. It also displays the images you have captured.

---

**Recording media –** 2 MB SDRAM available for image storage. External memory supports SD memory card up to 1 GB capacity.

---

**Digital zoom –** 4X digital zoom permits zoom photography.

---

**Flexible flash settings –** Change the flash setting according to your lighting environment and photography mode setting.

---

**Focus mode –** Images can be captured with the distance to the subject set by normal and macro.

---

**Shooting mode –** Capture different still images including single, self-timer, continuous 1.3MP and continuous VGA.

---

**Video mode –** Record video clips without voice.

---

**Thumbnail display –** Displays a set of 6 images on the LCD monitor for easier and quicker selection of images.

---



## Package Contents

Carefully unpack your ViviCam 3105s and ensure that you have the following items.

### Common Product Components:

- ViviCam 3105s
- User's manual
- Software CD-ROM
- USB cable
- ViviCam 3105s strap
- ViviCam 3105s pouch

### Common (Optional) Accessories:

- SD memory card
- Batteries



## Note

- Accessories and components vary by retailer.

# GETTING TO KNOW YOUR VIVICAM 3105S

## Front View

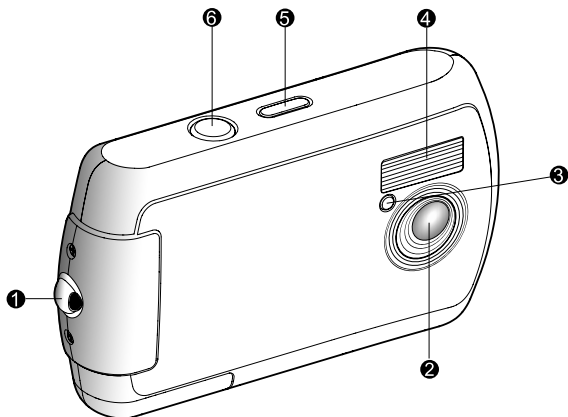

#	Name	Description
1	Strap holder	ViviCam 3105s strap attachment.
2	Lens	Designed to collect and focus rays of light to form a sharp image on the sensor.
3	Self-timer LED	Blinks during Self-timer mode until image is captured.
4	Flash	Provides flash illumination.
5	<b>POWER</b> (Power) button	Turns the ViviCam 3105s power on and off.
6	Shutter button	Captures an image or records a video clip when the button is pressed.

## Rear View

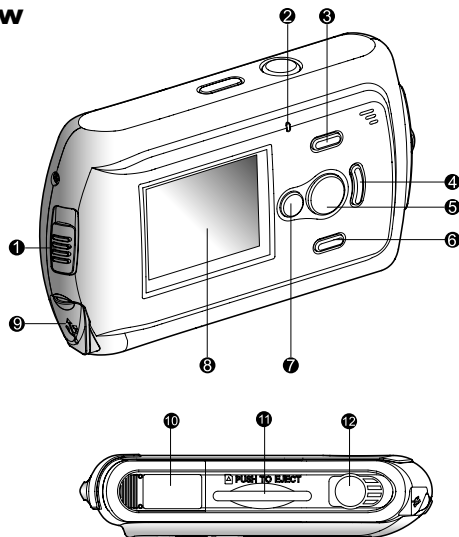

#	Name	Description
1	Focus switch ▲ Normal mode 🌸 Macro mode	Allows you to choose the appropriate focus setting. Allows you to capture images of subjects at a distance of 1.5m to infinity (59"~infinity). Allows you to capture close-ups of subjects up to the distances from 0.4 - 0.6m (15.7"~23.6").
2	Status LED	Displays the ViviCam 3105s current state.
3	▲ button ▶ Playback button	Scrolls upward. Enters or exits playback mode.
4	▶ button MODE button	Scrolls right. Sets the ViviCam 3105s mode.
5	SET button ⚡ Flash button	Confirms the chosen settings. Allows you to choose the appropriate flash setting.
6	▼ button MENU button	Scrolls downward. Toggles OSD menu on and off.
7	◀ button Q Zoom button	Scrolls left. Zooms in/out the image.
8	LCD monitor	Provides menu information to operate the ViviCam 3105s and previews the image before capturing it and review it afterwards.
9	USB connector	Connects a USB cable to the ViviCam 3105s.
10	Battery cover	Allows to load the batteries.
11	Memory card cover	Accesses to the memory card.
12	Tripod socket	Allows tripod mounting.

## LED Indicator & Beep

This describes the color and state of the LED indicator.

LED	Color	State	Description
Self-timer	Red	Blinking	Self-timer function is activated.
Status	Green	Blinking	Flash charging in progress.
		On	ViviCam 3105s is powered on. Charging process is completed.
	-	Off	Flash is off.

### Beep

Beep	Description
1 sound	The ViviCam 3105s is powered on.
	ViviCam 3105s operation.
	Self-timer mode for the first 7 seconds.
	After an image / video clip is captured.
2 sounds	Cannot operate or undefined button function.
	Low battery power
4 sounds	Self-timer mode for the last 3 seconds.
No sound	Beeper is set to off.

## LCD Monitor Icons

### ■ Capture mode

1. Capture mode
2. Focus mode
  - [No icon] Normal mode
  - [🌿] Macro mode
3. Shooting mode
  - [No icon] Single
  - [🕒] Selftimer
  - [📷] Cont. 1.3MP
  - [📷] Cont. VGA
4. WB (White Balance)
  - [A] AUTO
  - [☀️] Daylight
  - [☁️] Cloudy
  - [🌙] Tungsten
  - [💡] Fluorescent
5. Size
  - [..] VGA
  - [...] 1.3MP
  - [..] 3MP
  - [::] 4MP
  - [:::] 5MP
6. Quality
  - [★] Normal
  - [★★] Fine
  - [★★★] Super Fine
7. Possible number of shots
8. Digital zoom indicator
9. Flash mode
  - [🚫] Flash off
  - [A🚫] Auto flash
10. Remaining battery status
  - [🔋] Full battery power
  - [🔋] Medium battery power
  - [🔋] No battery power (Blinking)
11. Storage media
  - [No icon] Internal memory
  - [💾] SD memory card

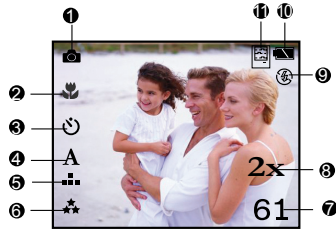

### ■ Video mode

1. Video mode
2. Storage media
3. Remaining battery status
4. Possible recording time
5. Size
6. Focus mode (at preview mode only)



### ■ Playback mode-Still image playback

1. Capture mode
2. Protect icon
3. File number / total files

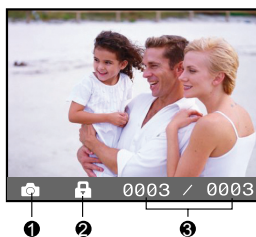

### ■ Playback mode-Video preview

1. Total recorded time
2. Video mode
3. Protect icon
4. File number / total files
5. Video playback/stop indicator

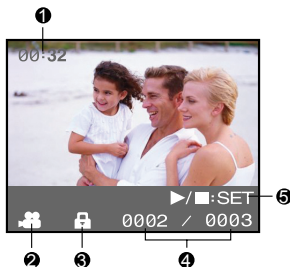

# GETTING STARTED

## Attaching the ViviCam 3105s Strap

Attach the ViviCam 3105s strap as shown in the illustration.

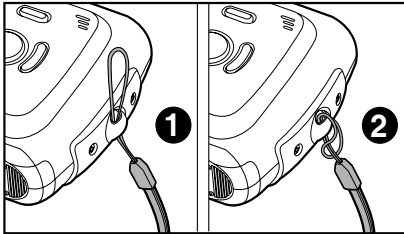

## Loading the Batteries (Optional Accessory)

You can use either 2 AAA size batteries (Alkaline or Ni-MH) to power the ViviCam 3105s.

1. Make sure the ViviCam 3105s is turned off.
2. Open the battery cover.
3. Load the batteries, noting correct polarity (+ and -).
4. Close the battery cover firmly.

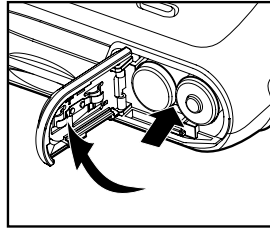

### Note

- The SDRAM needs power supply all the time to maintain its function. If the batteries are removed from the ViviCam 3105s, images stored in SDRAM may lose or the captured images may deteriorate or the ViviCam 3105s may not be operated normally or may shut down automatically. When one of the above issues occurred, remove the batteries from the ViviCam 3105s for approximate five to ten minutes, and then load the batteries again to turn on the power. In this case, the stored images have been deleted.

## Inserting and Removing the SD Memory Card (Optional Accessory)

The ViviCam 3105s comes with 2 MB SDRAM, allowing you to store images and video clips in the ViviCam 3105s. However, you can expand the memory capacity by using an optional SD memory card so that you can store more files.

### Inserting the SD memory card

1. Make sure the ViviCam 3105s is turned off.
2. Insert the SD memory card in the correct orientation shown.

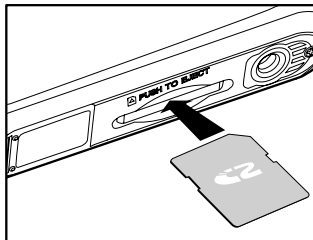

### Removing the SD memory card

Make sure the ViviCam 3105s is turned off. Press lightly on the edge of the SD memory card and it will eject.

### Note

- To prevent valuable data from being accidentally erased from an SD memory card you can slide the write-protected tab (on the side of the SD memory card) to "LOCK".
- To save, edit or erase data on an SD memory card, you must unlock the card.
- Be sure to format an SD memory card with this ViviCam 3105s before using it. Refer to section in this manual titled "Formatting the SD Memory Card or Internal Memory" for further details.

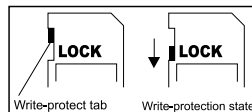



## Turning the Power On/Off

Load the batteries before starting.

### Turning the power on

1. Press the **POWER** button to turn the power on.
  - The status LED lights green and the ViviCam 3105s is initiated.
  - When the power is turned on, the ViviCam 3105s will start in the capture mode.

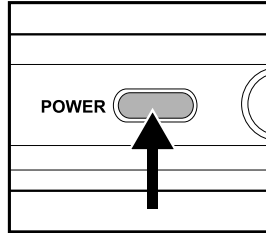

### Turning the power off

Press the **POWER** button to turn the power off.



### Note

- The power is turned off automatically when the ViviCam 3105s has not been operated for a fixed period of time. To resume the operation condition, turn the power on again. Refer to section in this manual titled "**Power Off**" in the **Setup Menu** for further details.

## Choosing the Language

Specify in which language menus and messages are to be displayed on the LCD monitor.

1. Toggle the **MODE** button to  $\%$  and press the **SET** button.
2. Select [Language] and toggle the **SET** button to select the displayed language.
3. To exit from the menu, press the **MENU** button.

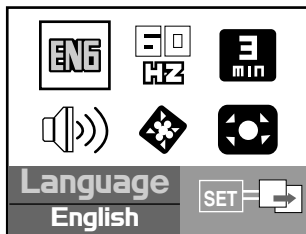

## Formatting the SD Memory Card or Internal Memory

This utility formats the SD memory card (or internal memory) and erases all stored images and data.

1. Toggle the **MODE** button to  $\%$  and press the **SET** button.
2. Select [Format] with the  $\blacktriangleleft / \blacktriangleright$  buttons and press the **SET** button.
3. Select  $\text{OK}$  with the  $\blacktriangleleft / \blacktriangleright$  buttons and press the **SET** button.
  - To cancel formatting, select  $\text{ESC}$  and press the **SET** button.
4. To exit from the menu, press the **MENU** button.

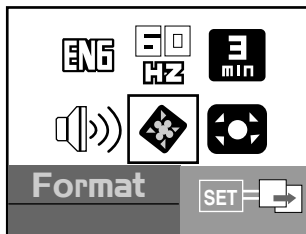

### Note

- To format the internal memory, do not insert an SD memory card into the ViviCam 3105s. Otherwise, you will format the SD memory card.
- Formatting the SD memory card also erases the protected images. All data other than images are also erased. Before formatting the card, make sure that all the images are unnecessary.
- Formatting is an irreversible action and data cannot be recovered at a later time.
- An SD memory card having any problem cannot be properly formatted.

## Setting Image Resolution and Quality

Resolution and quality settings determine the pixel size (dimension), image file size, and compression ratio for your images. These settings affect the number of images that can be stored. As you get to know the ViviCam 3105s, it is recommended that you try each quality and resolution setting to get an appreciation for the effects that these settings will have on your images.

Higher resolution and higher quality images offer the best photographic results but produce large file sizes. Therefore, few images will take up a lot of memory space. High resolution and quality settings are recommended for printed output and situations requiring the finest detail. Lower resolution/quality images take up less memory space and may be quite suitable for sharing images via e-mail, in a report, or on a web page.

To change image resolution or image quality, perform these steps below:

1. Toggle the **MODE** button to  and press the **SET** button.
2. Press the **MENU** button.
3. Select [Quality]/[Size] with the ◀ / ▶ buttons.
4. Toggle the **SET** button to select the desired setting.
5. To exit from the menu, press the **MENU** button.

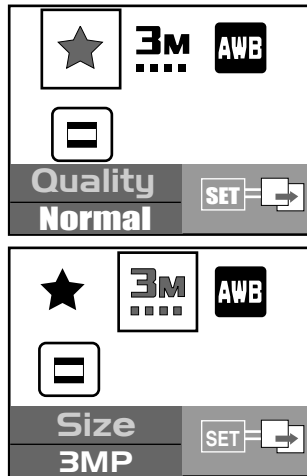

### Note

- In video mode, only size setting is available.

## Possible number of shots (still image)

The table shows the approximate shots that you can capture at each setting based on the capacity of the 2 MB SDRAM and SD memory card.

Size	Quality	2MB SDRAM	SD memory card capacity					
			32MB	64MB	128MB	256MB	512MB	1GB
5MP	★ Normal	2	44	90	182	367	737	1475
	★★ Fine	2	37	76	153	308	619	1239
	★★★ Super Fine	1	29	60	121	244	491	983
4MP	★ Normal	3	46	95	192	385	773	1549
	★★ Fine	2	38	79	160	321	644	1291
	★★★ Super Fine	2	31	63	128	257	515	1033
3MP	★ Normal	3	54	111	225	453	910	1822
	★★ Fine	3	45	92	187	376	755	1511
	★★★ Super Fine	2	37	76	153	308	619	1239
1.3MP	★ Normal	6	98	200	404	812	1629	3262
	★★ Fine	5	84	172	349	701	1407	2817
	★★★ Super Fine	4	66	135	274	551	1105	2213
VGA	★ Normal	14	207	490	853	1714	3439	6886
	★★ Fine	12	169	345	698	1402	2418	5634
	★★★ Super Fine	9	143	292	590	1187	2381	4767

## Possible recording time / sec (video clip)

Size	2MB SDRAM	SD memory card					
		32MB	64MB	128MB	256MB	512MB	1GB
VGA	00:07	01:53	03:52	07:49	15:42	31:30	1:03:05
QVGA	00:07	02:19	04:45	09:37	19:19	38:45	1:17:35

- \* The data shows the standard testing results. The actual capacity varies according to the shooting conditions and settings.
- \* Frame rate of video recording would be different depending on the SD memory card access speed. If using a low access speed SD memory card, it influences the frame rate and recording time.
- \* We recommend use a high speed SD memory card when recording video clips on VGA setting.

# CAPTURE MODE

## Normal Mode

Your ViviCam 3105s is equipped with a 1.5" TFT LCD monitor to help you compose images, playback recorded images/movie clips or adjust menu settings. Before you start capturing images, be sure that the focus switch is set to the appropriate photography mode.

1. Set the focus switch to ▲.
2. Press the **POWER** button.
3. Toggle the **MODE** button to  and press the **SET** button.
4. Compose your image in the LCD monitor.  
Place the subject of your photo at the center and press the shutter button.

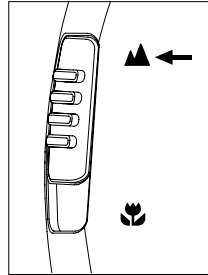



### Note

- The LCD monitor darkens in strong sunlight or bright light. This is not a malfunction.

## Macro Mode

For close-up of small subjects like flowers or insects, shoot using the Macro mode. You can use this feature for close-ups of subjects up to the distances from 0.4 – 0.6m (15.7"~23.6").

1. Set the focus switch to .
2. Press the **POWER** button.
3. Toggle the **MODE** button to  and press the **SET** button.
4. Compose the image and press the shutter button.

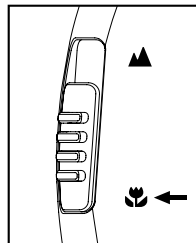

### Note

- The flash mode is automatically set to off for close-up photography.
- Don't forget to set the focus switch back to Normal mode (the focus switch is set to ) after close-ups shooting.

## Digital Zoom

Images appear closer when using the digital zoom.

1. Toggle the **MODE** button to  and press the **SET** button.
2. Compose the image on the LCD monitor.
3. Toggle the **Q** button to magnify up to 4x.

1X ↔ 2X ↔ 3X ↔ 4X

4. Press the shutter button to capture a "zoomed" image.





### Note

- The digital zoom function is not automatically cancelled after the image is captured.
- The digital zoom is only activated in single and self-timer shooting modes.
- 4MP and 5MP are made by F/W interpolation so the digital zoom is not available.



## Flash

Set the flash for capturing images. The flash firing mode can be set to suit for the photographic conditions. When the ViviCam 3105s is in Normal mode (the focus switch is set to ▲.), you can capture an image using a flash mode suitable to your circumstances.

1. Toggle the **MODE** button to  and press the **SET** button.
2. Toggle the  button until the desired flash mode appears.
3. Compose the image and press the shutter button.



The available flash settings in normal mode:

Flash mode	Description
 Flash off	The flash will not fire. Select this mode when taking images in a place where flash photography is prohibited, or when the distance to the subject is beyond the effective range of the flash.
 Auto flash	The flash fires automatically according to the ambient lighting conditions. Select this mode for general flash photography.

### Note

- Flash off is the default setting.
- The flash mode is automatically set to off for close-up photography.
- If you will not be using the flash, turn it off. Turning the flash OFF will result in faster ViviCam 3105s startup and faster operation because the capacitor will not be charged needlessly. Turning the flash OFF when not needed, will also improve battery life.



## Shooting Mode

This sets the recording method at the time of capturing images. You can capture different still images including single, self-timer, continuous 1.3MP and continuous VGA.

1. Toggle the **MODE** button to  and press the **SET** button.
  - a. Press the **MENU** button.
  - b. Select [Shooting] with the ◀ / ▶ buttons.
  - c. Toggle the **SET** button to select the desired option item.
  - d. Press the **MENU** button to exit from the menu screen.
2. Compose the image and press the shutter button.



This table below will help you choose the appropriate shooting mode:

Shooting mode	Description
(No icon) Single	Captures an image at a time.
 Self-timer	The image is captured about 10 seconds after the shutter button is pressed. The self-timer LED blinks slowly for 7 seconds and then blinks rapidly for the last 3 seconds. This allows you to get into the scene when taking group images.
 Cont. 1.3MP	Permits continuous photography of 3 images max with the image size of 1.3MP.
 Cont. VGA	Permits continuous photography of 3 images max with the image size of VGA.



# Video Mode

## Recording Video Clips

This mode allows you to record video clips (without audio) at a resolution of VGA / QVGA pixels.

1. Press the **POWER** button.
2. Toggle the **MODE** button to  and press the **SET** button.
3. To start recording a video clip, press the shutter button.
  - The recording time depends on the storage size and the subject of the image to be recorded.
4. Pressing the shutter button again stops recording.







### Note

- Flash cannot be used.

# PLAYBACK MODE

## Playing Back Still Images

You can play back still images on the LCD monitor.

1. Press the **POWER** button.
2. Press the  button.
  - The last image appears on the screen.
3. Select the desired image with the  /  buttons.
  - To view the previous image, press  button.
  - To view the next image, press  button.

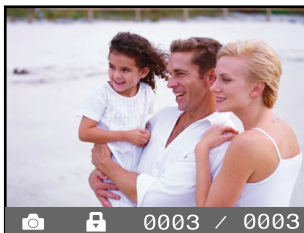





### Note

- Images are played back from the following storage media:
  - \* When no memory card is loaded, it plays back from internal memory.
  - \* When an SD memory card is loaded, it plays back from SD memory card.
- If there are no images stored in memory,  icon will appear on the LCD monitor.

## Playing Back Video Clips

You can play back video clips on the LCD monitor.

1. Press the  button.
  - The last image appears on the screen.
2. Select the desired video clip with the  /  buttons.
  - To view the previous video clip, press  button.
  - To view the next video clip, press  button.
3. Press the **SET** button.
  - Playback begins.
  - The elapsed time is displayed on the LCD monitor.
  - Press the **SET** button again to stop the playback.

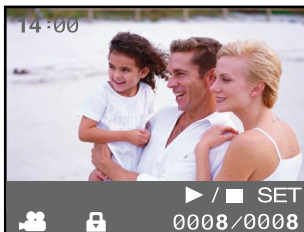



### Note

- To play the video clip back on your computer, you may use either Windows Media Player or Apple "QuickTime Player".
- QuickTime basic player is available free of charge, compatible with both Mac and Windows- computers and can be download from the Apple web site at [www.apple.com](http://www.apple.com). For help using QuickTime Player usage, please refer to the QuickTime on-line help for more information.

## Slideshow Display

The slideshow function enables you to playback still images automatically in order one image at a time.

1. Press the  button.
2. Press the **MENU** button.
3. Select [Slide Show] with the  /  buttons and press the **SET** button.
  - The slideshow starts.
  - All still images in the folder are automatically played back.
4. To stop the slideshow during playback, press the **SET** button.







### Note

- Video clips are displayed the first frame image, and they are not played back.

## Protecting Images





Set the data to read-only to prevent images from being erased by mistake.

1. Press the  button.
2. Press the **MENU** button.
3. Select [Protect] with the  /  buttons and press the **SET** button.
4. Select  and press the **SET** button
  - Protection is applied to the image and the ViviCam 3105s returns to the playback mode.
  - The protect icon  is displayed with protected images.



## Thumbnail Display

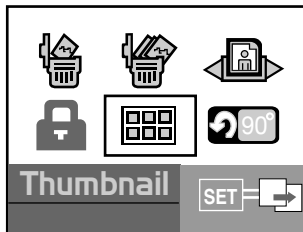

This function allows you to view as many as 6 thumbnail images on the LCD monitor simultaneously so you may search for a particular image.

1. Press the  button.
2. Press the **MENU** button.
3. Select [Thumbnail] with the  /  buttons and press the **SET** button.
4. Press the  /  buttons to select the image to be displayed at regular size.
5. Press the **SET** button.
  - The selected image is displayed at its regular size.



## Rotating the Image





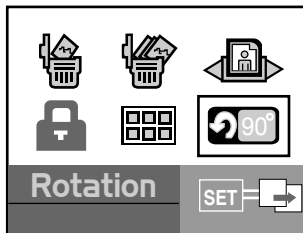



You can rotate still images during image playback.

1. Press the  button.
2. Press the **MENU** button.
3. Select [Rotation] with the  /  buttons and press the **SET** button.
  - The image is in a 90 degree rotated and displayed counterclockwise.
4. Repeating the steps 2 –3 will return the image to the normal display.



# Deleting Images

## Deleting single image / Deleting all images

1. Press the  button.
2. Press the **MENU** button.
3. Select the [Delete] or [Delete All] with the  /  buttons and press the **SET** button.
  - Delete: Deletes the selected/last image/video clip except for the protected file.
  - Delete All: Deletes all of the images/video clips except for the protected files.
4. Select  with the  /  buttons and press the **SET** button.
  - To not delete, select  and press the **SET** button.
  - =0 is displayed when no images are stored in the memory card (or internal memory).

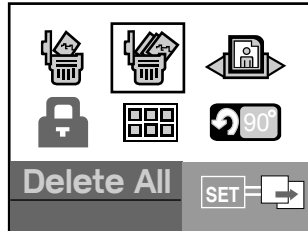
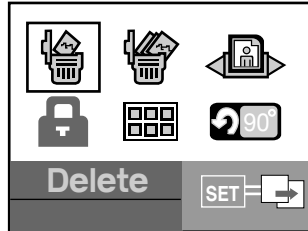



### Note

- To delete images or videos stored in internal memory, do not insert a memory card into the ViviCam 3105s. Otherwise, you will delete the images or video clips stored on the memory card.

# MENU OPTIONS

## Capture Menu



This menu is for the basic settings to be used when capturing still images.

1. Toggle the **MODE** button to  and press the **SET** button.
2. Press the **MENU** button.
3. Select the desired option item with the  /  buttons.
4. Toggle the **SET** button to select the desired setting.
5. To exit from the menu, press the **MENU** button.



### ■ Quality

This sets the quality (compression rate) at which the image is captured.

- \* [] Normal
- \* [] Fine
- \* [] Super Fine

### ■ Size

This sets the size of the image that will be captured.

- \* [] VGA
- \* [] 1.3MP
- \* [] 3MP
- \* [] 4MP
- \* [] 5MP

### ■ WB (White Balance)

This sets the white balance capturing under a variety of lighting conditions and permits images to be captured that approach the conditions that are seen by the human eye.

- \* [] AUTO
- \* [] Daylight
- \* [] Cloudy
- \* [] Tungsten
- \* [] Fluorescent

### ■ Shooting

Refer to section in this manual titled “**Shooting Mode**” for further details.

## Video Menu

This menu is for the basic settings to be used when recording video clips.

1. Toggle the **MODE** button to  and press the **SET** button.
2. Press the **MENU** button.
3. Toggle the **SET** button to select the desired setting.
4. To exit from the menu, press the **MENU** button.

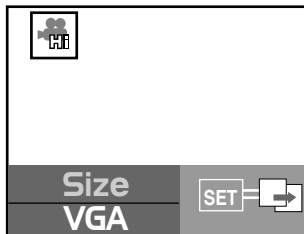

- **Size**







This sets the size of the video clip that will be recorded.

\* [..] VGA

\* [.] QVGA

## Playback Menu

In the  mode, set which settings are to be used for playback.

1. Press the  button.
2. Press the **MENU** button.
3. Select the desired option item with the  /  buttons.
4. Press the **SET** button to enter its sub-menu or execute its function.
5. Select the desired setting with the  /  buttons and press the **SET** button.
6. To exit from playback mode, press the  button.

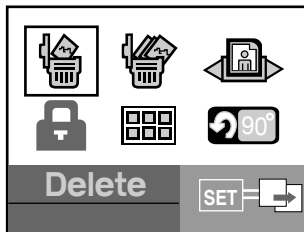

- **Delete**

Refer to section in this manual titled "Deleting Images" for further details.

- **Delete All**

Refer to section in this manual titled "Deleting Images" for further details.

- **Slideshow**

Refer to section in this manual titled "Slideshow Display" for further details.

- **Protect**

Refer to section in this manual titled "Protecting Images" for further details.

- **Thumbnail**



Refer to section in this manual titled "Thumbnail Display" for further details.

- **Rotation**

Refer to section in this manual titled "Rotating Images" for further details.

## Setup Menu

Set your ViviCam 3105s' operating environment.

1. Toggle the **MODE** button to  and press the **SET** button.
2. Select the desired option item with the  /  buttons.
3. Toggle the **SET** button to select the desired setting.
4. To exit from the menu, press the **MENU** button.



- **Language**

Refer to section in this manual titled “Choosing the Language” for further details.

- **Frequency**

This ViviCam 3105s supports different lighting frequencies: 50 Hz and 60 Hz. When photographing under fluorescent lighting, select the correct frequency setting depending in your local area's voltage. This function is only effective if you set the White Balance to Fluorescent setting.

\* 50Hz / 60Hz

- **Power Off**

If no operation is performed for a specific period of time, the power to the ViviCam 3105s is automatically turned off. This feature is useful to reduce battery wear.

\* 1 Min. / 3 Min. / Off

- **Beeper**

This sets whether or not to mute the ViviCam 3105s sound each time you press the ViviCam 3105s button.

\* On / Off

- **Format**

Refer to section in this manual titled “Formatting the SD Memory Card or Internal Memory” for further details.

- **Reset**

This returns all basic settings to the ViviCam 3105s' default settings.



# TRANSFERRING RECORDED IMAGES AND VIDEOS TO YOUR COMPUTER

To transfer images/video clips from the ViviCam 3105s to your computer, follow these steps:

**Step 1:** Installing the USB driver (Windows 98 users only)

**Step 2:** Connecting the ViviCam 3105s to your computer

**Step 3:** Downloading images and video files

## System Requirements (Windows)

- Pentium 166 MHz or higher
- Windows 98/98SE/Me/2000/XP
- 64MB RAM
- 128MB hard disk space
- CD-ROM drive
- Available USB port

## System Requirements (Macintosh)

- PowerPC G3/G4
- OS 9.0 or later
- 64MB RAM
- 128MB hard disk space
- CD-ROM drive
- Available USB port

## Step 1: Installing the USB Driver

### Windows 98 computers

The USB driver on the CD-ROM is exclusively for Windows 98 computers. Installing the USB driver on computers running Windows 2000/ME/XP is not necessary.

1. Insert the CD-ROM that came with the ViviCam 3105s into your CD-ROM drive.  
The welcome screen appears.
2. Click **"INSTALL USB/PC CAM DRIVER"**. Follow the on-screen instructions to complete the installation. After the USB driver has been installed, restart your computer.



### Note

- The USB driver that bundled inside the CD-ROM is designed in a form 2 in 1 (USB & PC camera).
  - a) On Windows 98, the Windows OS will install both USB & PC camera drivers.
  - b) On Windows 2000/ME/XP, it will only install PC camera driver.

## Macintosh OS 9.0 computers

For Mac OS 9.0 or higher, the computer will automatically recognize the ViviCam 3105s and load its own USB drivers.

### Step 2: Connecting the ViviCam 3105s to Your Computer

1. Connect one end of the USB cable to the USB terminal of the ViviCam 3105s.
2. Connect the other end of the USB cable to an available USB port on your computer.
3. Select  with the ◀ / ▶ buttons and press the **SET** button.
4. From the Windows desktop, double click on "My Computer".
5. Look for a new "Removable disk" icon. This "Removable disk" is actually the memory card in your ViviCam 3105s. Typically, the ViviCam 3105s will be assigned drive letter "e" or higher.
6. Double click on the removable disk and locate the DCIM folder.
7. Double click on the DCIM folder to open it to find more folders.
  - Your recorded images and video clips will be inside these folders.
  - Copy & Paste or Drag-N-Drop image and video files to a folder on your computer.

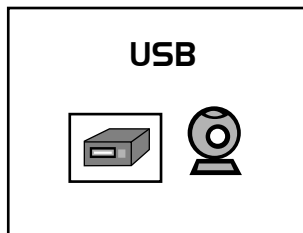
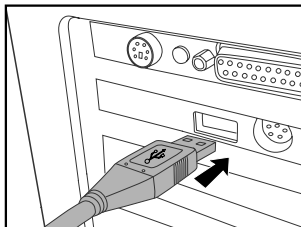

**Mac users:** Double-click the "untitled" or "unlabeled" disk drive icon on our desktop. iPhoto may automatically launch.

## Step 3: Downloading Images and Video Files

When the ViviCam 3105s is turned on and connected to your computer, it is considered to be a disk drive, just like a floppy disk or CD. You can download (transfer) images by copying them from the "Removable disk" ("untitled" or "unlabeled" disk on a Macintosh) to your computer hard drive.

### Windows

Open the "removable disk" and subsequent folders by double clicking on them. Your images are inside these folder(s). Select the images that you want, and then choose "Copy" from the "Edit" menu. Open the destination location (folder) and choose "Paste" from the "Edit" menu. You may also drag and drop image files from the ViviCam 3105s to a desired location.

### Macintosh

Open the "untitled" disk icon, and the destination location on your hard disk. Drag and drop from the ViviCam 3105s to the desired destination.



### Note

- Memory card users may prefer to use a memory card reader (highly recommended).
- Video playback application is not included with the package. Make sure that video playback application has been installed in your computer.

## USING THE VIVICAM 3105S AS A PC CAMERA

Your ViviCam 3105s can act as a PC ViviCam 3105s, which allows you to videoconference with business associates, or have a real-time conversation with friends or family. To use the ViviCam 3105s for videoconferencing, your computer system must include the items as below:

- Microphone
- Sound card
- Speakers or headphones
- Network or Internet connection



### Note

- Video conferencing (or video editing) software is not included with the ViviCam 3105s.
- This mode is not supported on the Mac.

### Step 1: Installing the PC ViviCam 3105s driver

The PC- camera driver included in the CD-ROM is exclusively for Windows. The PC camera function is not supported for Mac platforms.

1. Insert the CD-ROM that came with the ViviCam 3105s into your CD-ROM drive.
2. When the welcome screen appears, click **"INSTALL USB/PC CAM DRIVER"**. Follow the on-screen instructions to complete the installation.
3. After the driver installation is completed, restart your computer.



### Note

- The USB driver that bundled inside the CD-ROM is designed in a form 2 in 1 (USB & PC camera driver).
  - a) On Windows 98, the Windows OS will install both USB & PC camera drivers.
  - b) On Windows 2000/ME/XP, it will only install PC camera driver.

## Step 2: Connecting the ViviCam 3105s to your computer

1. Connect one end of the USB cable to the USB terminal of the ViviCam 3105s.
2. Connect the other end of the USB cable to an available USB port on your computer.
3. Select  with the ◀ / ▶ buttons and press the **SET** button.
4. Position the ViviCam 3105s steadily on top of your computer monitor or use a tripod.

## Step 3: Run your application software (i.e. Yahoo Messenger)

Yahoo Messenger is a free application available at [www.yahoo.com](http://www.yahoo.com). After installing the TWAIN driver in your Windows operating system, restart your computer. You can then use your ViviCam 3105s as a web cam allowing others to see you online.

Simply follow the instructions in Yahoo Messenger to start your camera.



### Note

- The video resolution for videoconferencing applications is generally 320 x 240.
- For more information about the operation of videoconference application software, refer to its respective help documentation.

# EDITING SOFTWARE INSTALLATION

## Installing Photo Explorer

Ulead® Photo Explorer provides a simple and efficient way to transfer, browse, modify and distribute digital media. Acquire photos, video or sound clips from various digital device types and easily browse or add personal descriptions; make timely modifications; or distribute the media through the medium of your choice: E-mail, Print, Slideshow Presentations. It is an indispensable all-in-one tool for owners of ViviCam 3105s, other digital cameras, WebCams, DV camcorders, scanners, or anyone who strives to effectively organize a large collection of digital media.

### To install Photo Explorer:

1. Insert the CD-ROM that came with the ViviCam 3105s into your CD-ROM drive. The welcome screen appears.
2. Click **“Install Photo Explorer 8.0”**. Follow the on-screen instructions to complete the installation.



### Note

- For more information about the operation of Photo Explorer application software, refer to its respective help documentation.
- For Windows 2000/XP users, please make sure to install and use the Photo Explorer in “Administrator” mode.
- Photo Explorer is not supported on the Mac. iPhoto or iPhoto2 is recommended.

## Installing Photo Express

Ulead® Photo Express is a complete photo project software for digital images. The step-by-step workflow, visual program interface, and in-program help assist users in creating exciting photo projects. Acquire digital photos effortlessly from ViviCam 3105s, other digital cameras or scanners. Organize them conveniently with the Visual Browse mode. Use hundreds of ready-to-use templates such as albums, cards, posters, slideshows, and more. Edit and enhance images with photo editing tools, photographic filters, and special effects. Embellish projects by adding creative design elements such as frames, callouts, and stamp objects. Share results with family and friends via e-mail and multiple print options.

### To install Photo Express:

1. Insert the CD-ROM that came with the ViviCam 3105s into your CD-ROM drive. The welcome screen appears.
2. Click "**Install Photo Express 5.0**". Follow the on-screen instructions to complete the installation.



### Note

- For more information about the operation of Photo Express application software, refer to its respective help documentation.
- For Windows 2000/XP users, please make sure to install and use the Photo Express in "Administrator" mode.
- Photo Express is not supported on the Mac.

## INSTALLING ADOBE READER

The CD-ROM includes a PDF (portable document format) copy of the user's manual. To view a PDF you must have Adobe Reader installed in your computer. Adobe Reader is included on the ViviCam 3105s CD-ROM. Using Adobe Reader, you can read the user's manual and print sections of interest.

1. Insert the CD-ROM that came with the ViviCam 3105s into the CD-ROM drive. The welcome screen appears.
2. Click "**Install Acrobat Reader**". Follow the on-screen instructions to complete the installation.



## USER'S MANUAL ON CD-ROM

A copy of the user's manual is provided on the CD-ROM in PDF format. It is a backup copy of the printed manual. If you misplace the printed guide, you may print another copy from the CD-ROM. The only requirement for viewing the User Manual on the CD-ROM is that you have Acrobat Reader installed on your computer. Updates to this manual, and versions in other languages may be found on our website [www.vivitar.com](http://www.vivitar.com).

1. Insert the CD-ROM that came with the ViviCam 3105s into the CD-ROM drive. The welcome screen appears.
2. Click "**Install User's Manual**". Follow the on-screen instructions to complete the installation. Alternatively, browse the CD-ROM to find the PDF file.

## VIVICAM 3105S SPECIFICATIONS

Item	Description
Image sensor	Approx. 3.2 Mega pixels
Image resolution	<Still image> 2560 x 1920 (F/W interpolation to 5 Mega pixels) 2304 x 1728 (F/W interpolation to 4 Mega pixels) 2048 x 1536 pixels 1280 x 960 pixels 640 x 480 pixels <Video clip> VGA pixels QVGA pixels
LCD monitor	1.5" color TFT LCD
Recording media	2 MB SDRAM available for image storage SD memory card (up to 1 GB capacity) (optional)
File format	JPEG, AVI for video clip
Lens	Focal length: f = 8.5mm F-number: 2.8
Focus range	Normal: 1.5m ~ infinity (59"~infinity) Macro: 0.4m ~ 0.6m (15.7"~23.6")
Frame rate	VGA: 10fps QVGA: 15fps
Digital zoom	4x digital zoom (Capture mode)
Terminal	USB connector
Power supply	2 AAA Alkaline (1.5V) or Ni-MH (1.2 V) batteries
Dimension (W x H x D)	Approx. 95.2x55.5x23.5mm (3.7" x 2.2" x 0.9")(without protruding parts)
Weight	Approx. 66g (2.3oz) (without batteries and memory card)

\* Design and specifications are subject to change without notice.

# TROUBLESHOOTING

Refer to the symptoms and solutions listed below before sending the ViviCam 3105s for repairs. If the problem persists, contact your local reseller or service center.

## Power supply

Symptom	Cause	Solution
The power does not come on.	The batteries are not loaded.	Load the batteries correctly.
	The batteries are exhausted.	Replace with a new set of batteries.
The power cuts out during use.	The ViviCam 3105s was left unattended and unused, so the auto power off cuts it off.	Turn the power back on.
	The batteries are exhausted.	Replace with a new set of batteries.
The batteries run out quickly.	It is being used in extreme low temperature.	
	Many shots are being captured in dark places inside, requiring flash.	
The batteries or ViviCam 3105s feels warm.	Long period of continuous use of the ViviCam 3105s or the flash.	

## Shooting

Symptom	Cause	Solution
Even if I press the shutter button, the ViviCam 3105s does not shoot.	The batteries are running low.	Replace with a new set of batteries.
	The power is not on.	Turn the power on.
	The ViviCam 3105s is not in shooting mode.	Toggle the <b>MODE</b> button to shooting mode.
	The internal memory or memory card does not have any free capacity.	Insert a new memory card, or delete unwanted files.
	End of memory card life.	Insert a new memory card.
	The flash is charging.	Wait until the status LED lights green.
	The memory card is unrecognized by the ViviCam 3105s.	Format the memory card in this ViviCam 3105s before its first use or when it was used other than this ViviCam 3105s.
	The auto power off function is activated.	Turn the power on again.
Images do not appear on the LCD monitor.	The memory card is write-protected.	Remove the write-protection.
	The power is not on.	Turn the power on.
The flash does not fire. The flash cannot recharge.	The flash is set to off.	Switch to another mode other than off.
The image is dark.	The image is captured in a dark place while set to flash off.	Set the flash to something other than flash off mode.

**Playback**

Symptom	Cause	Solution
Cannot playback.	It is not set to playback mode.	Press the  button to enter playback mode.
The contents of memory card cannot be played back.	You played back a memory card that was not formatted by this device.	Insert a memory card that was formatted and stored on by this device.
Files cannot be deleted.	The file is protected.	Cancel protection.
	You played back a memory card that was not formatted by this device.	Insert a memory card that was formatted and stored on by this device.
	The memory card is write-protected.	Remove the write-protection.
Cannot format a memory card.	The memory card is write-protected.	Remove the write-protection.
	End of memory card life.	Insert a new memory card.

**Other problems**

Symptom	Cause	Solution
Cannot insert the memory card.	The card is facing the wrong way.	Insert correctly.
Even when the ViviCam 3105s' buttons are pressed, it does not operate.	The batteries are running low.	Replace with a new set of batteries.

**About connecting to your computer/software**

Symptom	Cause	Solution
Cannot download images.	The free space on the hard disk in your computer may be insufficient.	Check whether the hard disk has a space for running Windows, and if the drive for loading image files has a capacity at least that of the memory card inserted in the ViviCam 3105s.
	The USB driver is not installed (for Windows 98/98SE).	Install USB driver.

## Free Manuals Download Website

<http://myh66.com>

<http://usermanuals.us>

<http://www.somanuals.com>

<http://www.4manuals.cc>

<http://www.manual-lib.com>

<http://www.404manual.com>

<http://www.luxmanual.com>

<http://aubethermostatmanual.com>

Golf course search by state

<http://golfingnear.com>

Email search by domain

<http://emailbydomain.com>

Auto manuals search

<http://auto.somanuals.com>

TV manuals search

<http://tv.somanuals.com>