

INSTRUCTION MANUAL

ViviCam 3765

3 Mega Pixel Digital Camera



Vivitar

About this Manual

This manual makes using the ViviCam 3765 Camera as easy as possible. Information in this manual has been checked for accuracy; however, the information is subject to change without notice.

Copyright

(c) Copyright 2004 Vivitar Corporation

This document contains proprietary information protected by copyright. All rights are reserved.

Trademarks

All trademarks and registered trademarks are the property of their respective owners.

Microsoft® and Windows® are U.S. registered trademarks of Microsoft Corporation.

Pentium® is a registered trademark of Intel Corporation.

Table of Contents

Chapter 1 – Getting Started	1
Safety Information	2
Included Components	4
Camera Overview.....	5
Front View.....	5
Back View.....	7
Bottom View.....	10
Inserting a Memory Card	11
Installing the Batteries	13
Selecting a Language	15
Setting the Time and Date	17
Chapter 2 - Capturing Images	21
Preparing the Camera	21
Selecting the Camera Mode	22
Framing the Shot.....	22
Zooming and Shooting	23
Turning off the Camera	23
Chapter 3 - Reviewing Your Images.....	24
Switching to Playback Mode	24
Full-Screen Review	24
Thumbnail Review	25
Chapter 4 - Connecting to a Computer	26
Installing Software.....	28
Transferring Images to your Computer	31
PC/web Camera mode	31

Chapter 5 - Mode / Operation Guide.....	33
(Still-Image) Capture Mode	33
Movie Mode	34
Preset Modes.....	35
Landscape	35
Portrait	36
Night Scene.....	36
Self-Timer	36
Macro.....	37
Playback Mode	37
Setup Mode.....	38
Delete All	39
Format	39
Quality.....	40
Buzzer	41
Date/Time.....	41
Memory Type	42
Language.....	43
Video Out	43
ISO.....	44
Welcome Screen.....	44
PC/Web Camera Mode.....	45
Chapter 6 - the LCD Display	46
LCD Icon Descriptions.....	47
Appendix 1 – Button Function Guide	49
Appendix 2 – Troubleshooting Guide	50

Chapter 1 – Getting Started

This chapter provides an overview of the features of the Vivicam 3675 camera overview and instructions on getting started.

V3765 Features:

- 3x Optical Zoom, 4x Digital Zoom
- Autofocus lens with macro function
- Native resolution of 2048 x 1472
- Interpolated resolution up to 2496 x 2016
- Color LCD viewfinder screen
- Optical viewfinder
- 16 MB Internal memory (14 MB available for image storage)
- Uses Secure Digital (SD) or MMC memory cards (not included) for memory expansion (up to 256 MB)
- Movie Clip Recording capability, with audio
- USB 1.1 interface (Mass-storage class)
- Automatic exposure with user-defined exposure capability
- Four-mode integral Flash
- Automatic White Balance with Preset Modes
- 10-second Timer mode
- Full screen or Thumbnail image review

Safety Information

- **Do not look at the sun through the viewfinder.** Viewing the sun or other strong light source through the viewfinder could cause permanent visual impairment.
- **Do not disassemble the camera.** Touching the internal parts could result in injury. In the event of a malfunction take the product to an authorized service center for inspection.
- **Avoid contact with liquid crystal.** Should the LCD display break, care should be taken to avoid injury due to broken glass. Prevent the liquid from touching the skin, eyes, or mouth.
- **Observe proper precautions when handling batteries.** The camera uses only size AA batteries. Batteries may leak or explode if handled improperly. Remove the batteries from the camera if you are going to store the camera for an extended period of time. Ensure the camera is turned off before inserting or removing batteries. Do not expose batteries to flame or excessive heat. Discontinue use immediately if you notice any changes in the battery such as discoloration, deformation or leakage.
- **Observe caution when operating the flash.** Do not use the flash close to anyone's eyes. This can cause temporary damage to eyesight. Particular care should be observed when imaging infants - keep the flash at a distance of at least 1 meter from infants' eyes.
- **WARNING:** Handling the USB and Video cables on this product may expose you to lead, a chemical known to the State of California to cause birth defects or other reproductive harm. Wash your hands after handling.

FCC STATEMENT

This device complies with Part 15 of the FCC Rules. Operation is subject to the following two conditions:

1. This device may not cause harmful interference, and
2. This device must accept any interference received, including interference that may cause undesired operation.

Note: This equipment has been tested and found to comply with the limits for Class B digital devices, pursuant to Part 15 of the FCC rules. These limits are designed to provide reasonable protection against harmful interference in a residential installation. This equipment generates, uses and can radiate radio frequency energy and, if not installed and used in accordance with the instructions, may cause harmful interference to radio communications. However, there is no guarantee that interference will not occur in a particular installation. If this equipment does cause harmful interference to radio or television reception, which can be determined by turning the equipment off and on, the user is encouraged to try to correct the interference by one or more of the following measures:

1. Reorient or relocate the receiving antenna
2. Increase the separation between the equipment and receiver
3. Connect the equipment into an outlet on a circuit different from that to which the receiver is connected
4. Consult the dealer or an experienced radio/TV technician for help

Use of shielded cable is required to comply with Class B limits in Subpart B of Part 15 of the FCC rules. Do not make any changes or modifications to the equipment unless otherwise specified in the manual. If such changes or modifications should be made, you could be required to stop operation of the equipment.

Included Components

The V3765 digital camera typically comes equipped with the following components. Check to make sure all items are included.

Note, however, that included accessories and components will vary, as specified by different retailers. Check with your retailer for specifics.

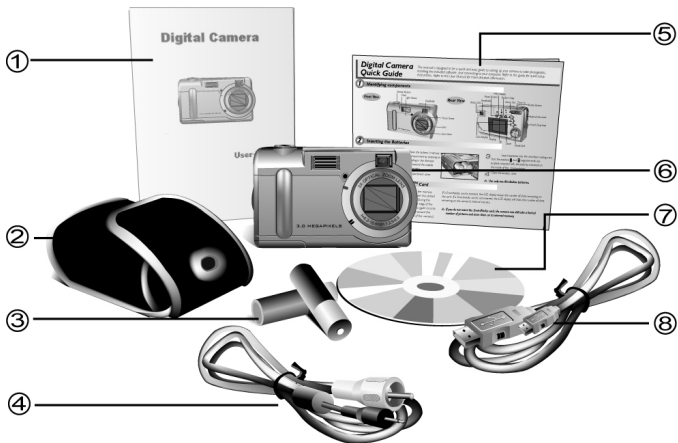

- | | |
|----------------------------------|--------------------------|
| 1. User's Manual | 5. Quick Reference Guide |
| 2. Soft Carrying Case | 6. V3765 Digital Camera |
| 3. Two (2) AA Alkaline Batteries | 7. Installation CD-ROM |
| 4. Video Cable | 8. USB Cable |

Camera Overview

The front, rear, and bottom views of the camera are shown on the following pages. Take a moment to review these illustrations to familiarize your self with the terms used in this manual.

Front View

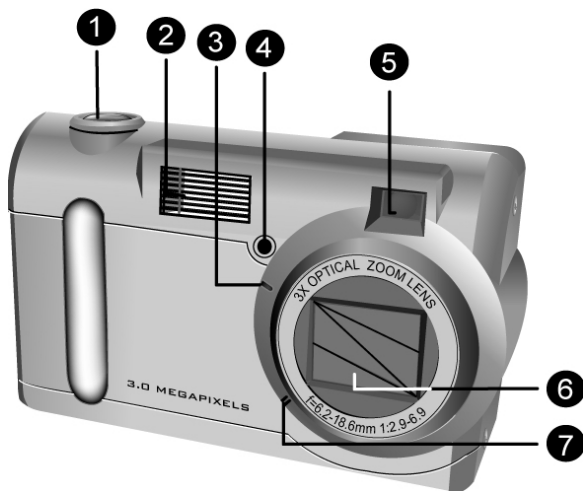

1. **Shutter Button:** Press this button to capture images, or to select menu options.
2. **Integral Flash:** The flash allows the camera to capture images in low light conditions and can





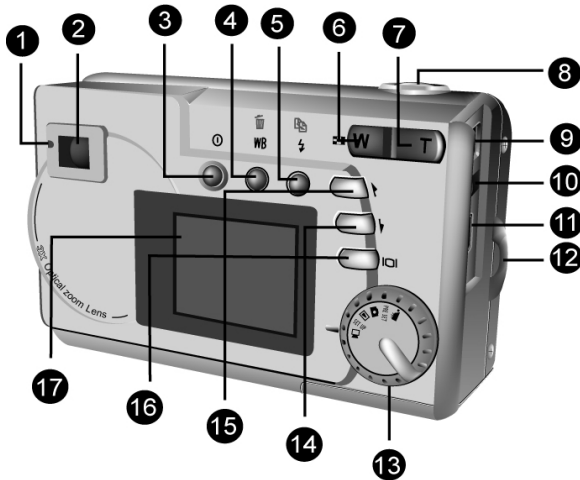

also be used in bright conditions to fill unwanted shadows.





3. **Self-Timer LED:** When the Self-Timer option is selected this LED blinks for ten seconds after the Shutter Button is pressed. At the end of the ten-second countdown the camera captures an image.
4. **Light Sensor:** Light measurements are made with this sensor. The camera detects the ambient light level and determines whether or not the flash should fire. Be careful not to block this sensor while capturing images.
5. **Viewfinder:** The viewfinder helps you frame an image. The actual image, however, is captured with the lens and not the viewfinder. For macro shots (close ups) use the LCD display for framing accuracy.
6. **Lens:** The lens focuses light onto the image sensor. For the optimal image quality, care should be taken to ensure that the lens remains free of dust, fingerprints, and scratches.
7. **Microphone:** Records audio when you use the camera for capturing movie clips.

Rear View



1. **Status LED:** This LED will flash orange when the camera is powered-on, or while the camera is processing an image. When the camera is again ready to capture an image or accept user commands, the LED will be solid green.
2. **Optical Viewfinder:** The optical viewfinder is used to frame your images. The optical viewfinder is essential for conditions of extreme brightness or darkness. The actual image is captured through the lens and not the viewfinder.

3.  **Power Button:** Press this button to turn on the camera. Press it again to turn the camera off.
4.  **WB/Delete:** In capture mode press this button to cycle through White Balance presets. In playback mode use this button to delete images.
5.  **Strobe / Copy:** In capture mode this button sets the flash mode. In playback mode, it copies images from internal camera memory to an SD/MMC Card (if present.)
6.  **Zoom Out Key:** In capture mode, press this key to zoom out. In playback mode if pressed repeatedly it switches between thumbnail  and full-screen views. If zooming in on an image during Playback, pressing this key zooms back out again.
7.  **Zoom In Key:** In capture mode, press this key to zoom in on your subject. In Playback mode, use this key to zoom in on an image.
8. **Shutter Button:** Press this button to capture a digital image. When navigating the camera's options menus, use it to select menu items.
9. **Power Jack:** Use this plug if using an AC Adapter or an external power source. (Not included)
10. **Video Out Jack:** Connect the video cable here (and the other end to your television set) to use the camera as a digital video camera or to playback your images on a TV.

11.  **USB Port:** The USB (Universal Serial Bus) port is used to connect the camera to a computer for transferring images. The USB port also enables PC users to use the camera as a PC/web Camera.
12. **Hand Strap Loop:** Attach the hand strap to this loop for ease of carrying.
13. **Mode Dial:** Rotate to select the camera mode: Movie, Preset, Capture, Playback, Setup, or PC/web Camera.
14.  **Down Button:** Used to move down through menus and to cycle to the next during image Playback.
15.  **Up Button:** Used to move up through menus and to cycle to the previous image during image Playback.
16.  **Display Button:** Press to cycle through the various display options: LCD, backlight and status information; LCD and backlight; LCD off; histogram.
17. **LCD Display:** You may use the LCD display to preview and frame your images. Always use the LCD display for framing macro shots. In conditions of extreme brightness or darkness use the optical viewfinder. While in the Setup menu, use the LCD to view messages and configure the camera.

Bottom View

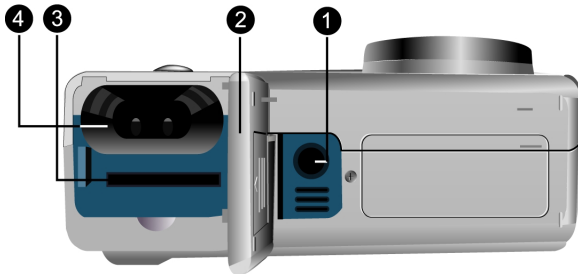

1. **Tripod Socket:** Attaches the camera to a common tripod using the popular $\frac{1}{4}$ -20 thread. (Tripod not included.) Use a tripod to hold the camera steady, especially for low light night images.
2. **Battery / Memory Card Cover:** Opens to allow access to the battery chamber and memory card slot.
3. **Memory Card Slot:** Holds an optional SD or MMC memory card to store images. For more information on memory cards refer to other sections of this manual including "Memory Type"
4. **Battery Chamber:** Requires two AA alkaline batteries. You may also use AA NiMH rechargeable batteries.

Inserting a Memory Card

To insert a memory card:

1. Turn off the camera.

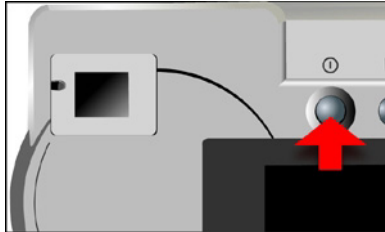

2. Open the battery / memory card compartment by pressing the cover and sliding in the direction of the arrow as shown.

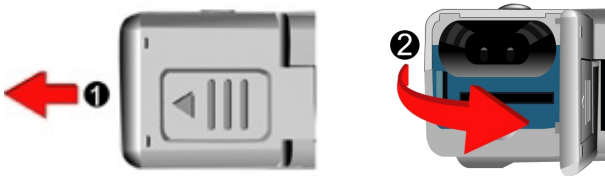

V3765 Digital Camera User's Manual

3. Insert the memory card with circuitry (pins) first. The notched corner of the memory card points towards the camera lens. The manufacturers label on the memory card will face the front (lens side) of the camera.

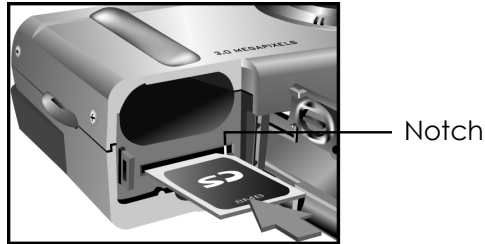

4. Close the battery / memory card cover.

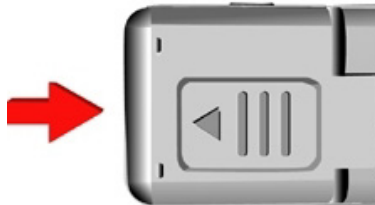

Note: The maximum usable memory card for the 3765 camera is 256 MB

Installing the Batteries

To install or replace the batteries:

1. Turn off the camera.

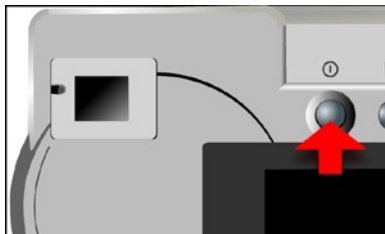

2. Open the battery compartment on the bottom of the camera by pressing the cover and sliding in the direction of the arrow as shown.



V3765 Digital Camera User's Manual

3. Insert batteries into the chamber making sure that the positive (+) and negative (-) ends are properly oriented, as indicated by the battery icons in the compartment.

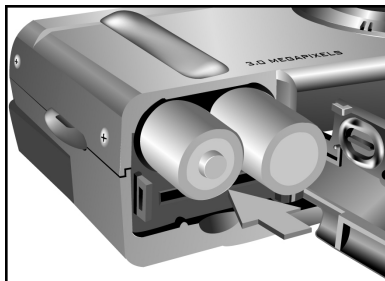

4. Close the battery cover.

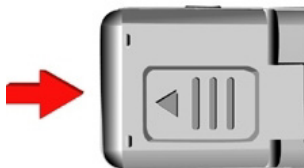

Selecting a Language

The 3765 camera can display text and messages in English, French, Spanish, German, Italian, Japanese and Simplified Chinese.

To select a different language:

1. Rotate the Mode Dial to Setup mode SET UP.

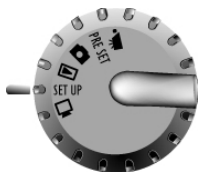

2. Turn the camera on.

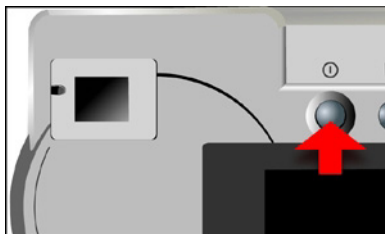

V3765 Digital Camera User's Manual

3. Use the Down button (▼) to select Language and then press the Display button (|◻|).



4. Use the Up and Down buttons (▲) / (▼) to select the language you wish to use.



5. Press the Display button (|◻|) to set the language. The Setup Menu returns.

Setting the Time and Date

The time and date are stored with each image you capture. When you transfer an image to a computer the time and date associated with that image will be transferred as well.

To set the date display style:

1. Rotate the Mode Dial to Setup SET UP.

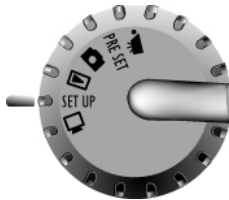

2. Turn on the camera.

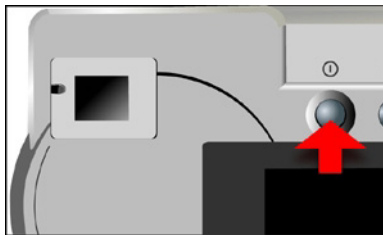

V3765 Digital Camera User's Manual

- Use the Down button (▼) to select Date/Time and then press the Display button (OK).

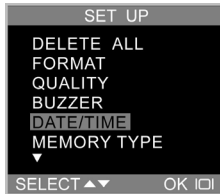

- Use the Down button (▼) to select Style and then press the Display button (OK).



- Choose the display style for the date.



Setting the Time and Date

- When the settings are correct, press the Display button  to save the changes.



To set the date and time:

- Use the Down button  to select Date/Time and then press the Display button .



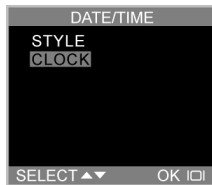

- Use the Down button  to select the Clock option and then press the Display button .





- Use the Up and Down buttons  /  to adjust the hour. Press the Strobe/Copy   button to set the hour and then move on to minutes.

V3765 Digital Camera User's Manual



4. Set the minutes in the same manner. Press the Strobe/Copy button   to set the minutes and move on to the next option.
5. Repeat step 3 to set the year, the month, and the day.
6. When the settings are correct, press the Display button  to save the changes.

NOTE: If you make a mistake and need to go back, use the White Balance/Delete button  .

Chapter 2 - Capturing Images

This chapter shows you how to capture images with your 3765 camera.

Preparing the Camera

To prepare the camera for capturing images:

Press the Power button to turn the camera on. After a short pause, the LED will stop flashing, signaling that the camera is ready to use.

NOTES:

- Make sure you have installed two AA batteries.
- If you want to store your images on an SD/MMC memory card, make sure it is inserted before you turn on the camera. If you want to store images to the camera's internal memory, either remove the memory card, or select "Internal" from the Memory Type menu.
- Using the LCD display consumes battery power. To prolong the life of your batteries it is recommended that you turn off the LCD display when not in use.

Selecting the Camera Mode

There are two modes for capturing images: Capture and Preset. Capture mode is for basic image capture, while Preset mode allows you to capture images in one of five preset schemes: Landscape, Portrait, Night Scene, Self-Timer, and Macro.

Rotate the Mode Dial to the mode you wish to use.

For basic "point and click" image capture, use the Capture mode indicated by the camera icon .



To use the self-timer, rotate the Mode Dial to Preset mode and then use the Up and Down buttons to select the Self-Timer mode.

Framing the Shot

Hold the camera steady to avoid capturing blurry images. Use either the Viewfinder or the LCD display to frame the image. Turning off the LCD display and capturing images with just the Viewfinder results in longer battery life. However, in some conditions it may be more convenient to use the LCD display. Always use the LCD display for framing macro shots.

Zooming and Shooting

Zoom in on a particular object

You can use the Zoom In  or Zoom Out  buttons to narrow or widen the camera's field of view. Use either the LCD display or the optical viewfinder to preview the effects of the zoom function.

Automatic Image Processing

Pressing the Shutter button halfway down initiates the camera's internal image processing functions. The camera adjusts white balance, exposure, and autofocus. In automatic flash mode, the camera determines whether or not the flash is required.

Capture the image

When you are satisfied with the preview, completely (slowly) press the Shutter button. Take care not to press the Shutter button too rapidly or forcefully; otherwise you might shake the camera and get a blurry image as a result.

Turning off the Camera

When you are finished capturing images, press the power button to turn it off. This conserves battery power.

Chapter 3 - Reviewing Your Images



One benefit of digital cameras is that you can immediately preview the image you just captured.







Switching to Playback Mode

To view the images that you have stored in internal memory or on an SD/MMC Card, rotate the Mode Dial to **Playback Mode**  and turn the camera on.



If the LCD display is not turned on, press the Display button . Cycle through the modes by repeatedly pressing the Display button.



Full-Screen Review

The default Playback method is to show each individual image, one at a time, sized to fit the full-screen. Press the Up and Down buttons  /  to cycle through the images you've captured.

Playback Zoom. You can also use the Zoom buttons  /  to see more detail of an image. The default zoom setting is 1x where you see the entire image in the LCD display. Press Zoom In  to increase the zoom ratio from 1x to 8x in .5x increments. Press the Zoom Out button  to decrease zoom ratio. Use the Up and Down buttons  /  to navigate (traverse) a zoomed image.

Thumbnail Review

If you press the Zoom Out button  when the zoom ratio is at x1 (default), the camera switches to Thumbnail Review .

In Thumbnail Review, up to nine images are shown on the LCD simultaneously. Use the Up and Down buttons  /  to cycle through the thumbnail pages.

To return to Full-Screen Review, select the image you want to view and press either the Shutter button or the Zoom Out button. The selected image will then expand to fill the entire LCD display.

Chapter 4 - Connecting to a Computer

The 3765 camera stores images as digital data rather than on film. Instead of making a trip to a developer and printing from negatives, you can copy your images to a computer for storage.

Once transferred, your images can be viewed, edited, printed, sent via e-mail, placed on a web page, added to a report, uploaded to a photo-processor, or saved to any removable media device (such as floppy disk or CD-ROM) for delivery to a photo finisher.

After successfully transferring images to your computer, images stored on the memory card or in the camera's internal memory may be deleted to make room for new images.

This chapter explains how to connect your digital camera to a computer to download images to a PC or to use as a PC Camera.

Do not connect the camera to your computer before installing the software. This may cause installation problems. It is best to install the software from the CD-ROM prior to connecting the camera to your computer.

The 3765 interfaces to your computer in either of two modes:

- 1) A mass storage device (a removable disk)
- 2) A PC (web) camera (PC users only)

This section explains how to connect your camera in either of these two modes. As a mass storage device you will be able

to access and view your images (photos), whereas the PC camera mode is for live video.

Which mode do you use?

- If you are interested in retrieving your digital images (images) from your camera you will need to use the **mass-storage** mode.
- If you wish to use your digital camera as a video camera where live (real-time) video is displayed on your computer use the **PC camera** mode.

Mass Storage Device. MSD is a name given to a USB product (like a digital camera) that works with your computer as if it was a removable disk. In essence the computer “sees” your camera as if it were a floppy disk or a CD ROM. The concept is simple. Think of the memory inside your camera as if it were a floppy disk (or a Zip disk, or a CD ROM). Think of the camera as a “reader”.

When you connect an MSD device to a computer it will appear as a new “drive.” Go to My Computer and observe the various drives. For example:

- 3-1/2” floppy drive (A:)
- Local disk (C:)
- CD ROM (D:)
- Removable disk (E:) **This is the Camera Memory**

PC Camera. The 3765 allows you to view live video from your camera on your computer using optional (third-party) video software. This mode is supported on Windows PCs only.

Installing Software

Follow these instructions to install the camera drivers and software on your system.

Follow these instructions to install the camera drivers and software on your system. Make sure to install the drivers **before** connecting the camera to your computer.

Operating System	MSD	PC Camera
Windows 98, 98SE	Driver required	Driver required
Windows Me, 2000, XP	No Driver required	Driver required
Mac OSX	No Driver required	Feature not supported
Desktop/LX (Linux)	No Driver required	Feature not supported

Note that Windows Me, 2000, and XP users do not need drivers to operate the camera in MSD mode, whereas drivers are required for PC Camera operation.

Note: Have your Windows CD-ROM ready beforehand, as you may be prompted to insert it during the installation process.

Step 1: Utility Installation

1. Insert the V3765 CD into your CD-ROM drive. Don't connect the camera to the PC at this time.
2. The installation program should start automatically. If not, double click the My Computer icon on your desktop, open the CD-ROM drive, and then run the 'setup.exe' found on the installation CD-ROM.
3. Follow the on-screen instructions. All the necessary software is installed automatically. The utility program that allow the camera to 'talk' to the computer via the USB cable are also installed.

Step 2: MSD / PC Camera Driver Installation

1. To install the necessary drivers for Mass Storage Device (MSD) mode (for Windows 98 users) and PC Camera mode (all Windows users), first set the correct operational mode for that function. For example, set the Mode Dial to PC Camera mode to install those drivers, and to any other mode to install Mass Storage Device drivers.
2. Connect the small connector of the USB cable to the camera, as shown:

V3765 Digital Camera User's Manual

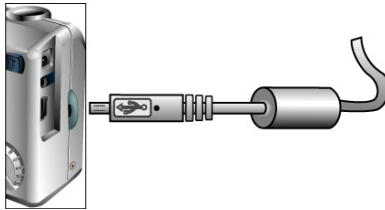

3. Connect the large end of the USB cable to an open USB slot on your computer. To locate USB slots on your computer, look for the USB icon .

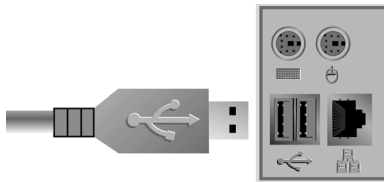

4. The Windows Add Hardware Wizard will automatically detect the camera and lead you through the installation procedures for each camera mode.
5. You will need to do this once for each mode (PC/web Camera and MSD mode.)

NOTE: You should reboot your computer before using camera and software for the first time. Remember to connect your camera to the PC with the USB cable before downloading images.

Copying Images to your Computer

When connected to your computer in MSD mode, the digital camera behaves exactly like any another disk drive attached to your computer. This makes copying the images to your hard drive as easy as copying files from a floppy disk, zip drive or CD-ROM.

To copy images to your computer:

1. Connect the digital camera to the computer with the USB cable.
2. Turn on the camera.
3. Open Windows Explorer. The contents of your computer will be displayed, including all your disk drives, and, if the camera is connected properly, an extra disk drive representing the camera's memory called "Removable Disk."
4. Select the digital camera drive. The camera's images are listed. Select the images and drag and drop them onto your computer's hard disk.

PC/Web Camera Mode

Windows PC users can use the 3765 as a PC/Web Camera, you must put the camera in PC Camera mode  and then connect it to your PC via the USB port.

When connected, the camera may be used in conjunction with any commercially available video

V3765 Digital Camera User's Manual

capture software to create your own home videos. Windows XP users can use Windows Movie Maker.

PC Camera mode can also be used with real-time video conferencing software such as Microsoft NetMeeting™.

NOTE: To use your camera as a PC/web Camera you must set the camera to PC Camera mode. To use the camera in MSD mode, you can use any of the modes **other than** PC Camera mode.

CAUTION: Do not disconnect the USB cable when the digital camera is functioning as a PC Camera (i.e. when an application window shows live camera video, or when the application is recording video). Unexpected problems could result.

Chapter 5 - Mode / Operation Guide

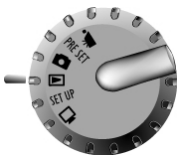

The 3765 camera has six operational modes. Select a mode by rotating the Mode Dial to the desired position. This chapter describes each mode and associated button functions.



Capture Mode



Capture mode is the most commonly used mode, offering the most automatic operation. The basic principles of photography apply to this mode.

Capture mode button functions:

- **▲ Up Button:** Increases the exposure value (eV), overriding the automatic exposure determination, effectively brightening the image.
- **▼ Down Button:** Decreases the exposure value, (eV), overriding the automatic exposure determination, effectively darkening the image.
- **|□| Display Button:** Cycles through the following LCD display settings: LCD with complete status information, include histogram, LCD without status information or histogram, LCD off.
- **⚡ |□| Strobe / Copy:** Specifies the strobe (flash) mode. Pressing the Strobe key cycles through the settings: Automatic, On (Fill), Auto with Red-Eye Reduction, Off.

- **WB**  **WB / Delete:** Specifies the White Balance setting. Pressing the WB key cycles through the following settings: Automatic, Day Light, Shade, Tungsten (incandescent), and Fluorescent Light.
- **W**  **Zoom Out:** Widens the field framed by the camera's lens from 3x to 1x.
- **T**  **Zoom In:** Narrows the field framed by the camera's lens optically from 1x to 3x in eight steps. After reaching the extent of the optical zoom you may also zoom digitally from 1x to 4x in steps of 0.2.

Movie Mode



Movie mode allows you record movie-clips (including audio).

To record a video clip:

1. Turn the Mode Dial to the Movie mode.
2. When the LCD screen comes on, frame your shot.
3. Press the Shutter Button to begin recording. Press the Shutter Button a second time to stop recording. Note that the camera will stop recording when memory is full.

You may zoom in and out digitally when recording videos but you cannot zoom optically. While capturing video you may use zoom as follows:

Digital zoom: You may change the digital zoom from 1x to 2x in steps of 0.2 while recording.

Optical zoom: You may set the optical zoom from 1x to 3x prior to recording. Note that you must set the optical zoom **before** recording. Once you begin recording the optical zoom cannot be changed.

Pressing the Up and Down buttons (▲) / (▼) while recording a video increases and decreases the lens' exposure value, which brightens or darkens the video.

Preset Mode

PRE SET

The Preset Mode has five pre-defined settings optimized for capturing specific types of scenes: Landscape, Portrait, Night Scene, Self-Timer, and Macro. Select the Preset appropriate to the scene you wish to capture using the Up and Down (▲) / (▼) buttons. Press the Shutter button to make a selection. Each of the five Preset-types are described in the following sections.

Landscape



The landscape preset is optimized for capturing landscape images where the desired object is far away. The lens will be adjusted for appropriate focus within the frame.

Portrait



The portrait preset is optimized for capturing "head shots" of people, focusing more on the center of the frame than on the peripheral areas.

Night Scene



The night scene preset is optimized for capturing images at night, opening the lens aperture wider and longer to gather as much ambient light as possible. You should hold the camera perfectly still when capturing night shot or place it on a stable surface or tripod to minimize blurring resulting from the longer exposure.

Self-Timer



Using the self-timer preset the camera captures an image after a ten second delay. This gives you the ability to capture hands-free images, such as self-portraits or group images.

To Capture a Group Image

1. Position the camera on a stable surface or on a tripod and frame the shot.
2. Rotate the Mode Dial to Preset mode

3. Use the Up and Down buttons to select the Self-Timer Preset.
4. Press the Shutter Button. The 10-second delay begins immediately. After ten-seconds the camera captures the image.

With the exception of the Shutter button, all of the camera's other buttons behave the same as they do in the other Preset modes.

Macro





The macro preset optimizes the camera for capturing close up shots of objects at a distance of 12 inches (30cm) or less from the camera. Close up images captured using the Macro preset will have sharper focus than close up images captured using other presets or Capture mode.

Playback Mode







Playback mode is used to view images stored in memory (either internal memory or on an SD memory card.) To view the images, rotate the Mode dial to the Playback position. (Press the Display  button to turn it on.)

Playback mode button functions:

-  Up Button: Move to the previous image.
-  Down Button: Move to the next image.

V3765 Digital Camera User's Manual

-  Display Button: Toggles the image information on/off.
-  Strobe / Copy: Copies the selected image from on-board memory to the memory card or vice versa.
-  WB / Delete: Deletes selected image.
-  Zoom Out: In Playback mode, the Zoom Out button switches the display to Thumbnail mode.
-  Zoom In: In Playback mode the Zoom In button magnifies the displayed image from 1x to 8x in steps of 0.5. Use the Up, Down, WB, and Strobe buttons to traverse a zoomed image.

Setup Mode

SET UP

Setup Mode is used to configure the camera. To open the Setup menu, rotate the Mode dial to the Setup position.

The Setup menu is displayed on the LCD as follows:



Delete All

To delete images from either the camera's internal memory or from an SD/MMC Card, select Delete All from the Setup menu.



Format

The format option completely erases and reformats memory. Although Format requires longer than Delete, be sure to format your storage device occasionally to ensure the card continues to function optimally.

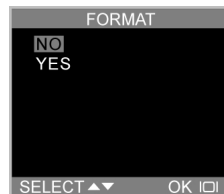

Quality

You can specify the resolution and quality of the images you capture in the Setup menu.



There are six resolution/quality combinations available:

Megapixel Count	Resolution (Horiz. x Vertical)	Quality
5.0 MP	2496 x 2016	Normal
3.0 MP	2048 x 1472	Fine
3.0 MP	2048 x 1472	Normal
2.8 MP	2048 x 1376	Fine
2.8 MP	2048 x 1376	Normal
0.7 MP	1024 x 736	Fine

The higher the resolution and quality, the sharper your images will be, but at the same time the image file size will be larger. Therefore you will be able to store fewer images in memory. 2048 x 1472 is the native resolution of the 3765. An interpolation method is employed to achieve the maximum effective resolution of 5.0M (2496 x 2016).

Buzzer

When the buzzer (beeper) is turned on, the camera generates a beep whenever you press a buttons or rotate the Mode dial.



To enable beep tones, select the Buzzer option from the menu. On the subsequent screen, select Yes to confirm and then press the Display button **|□|**.

Date/Time

The 3765 camera marks each image with a time stamp displaying the hour, minute and day the image was captured. This is useful for organizing and keeping track of your image collection.

For more on setting the time and date see page 17.

Memory Type

You can specify whether you want to store images in the on-board (internal) memory or on an SD/MMC Card.



To specify the memory to be used:

1. Rotate the Mode Dial to Setup SET UP.
2. Turn on the camera.
3. Use the Down button (▼) to select Memory Type and then press the Display button [O].

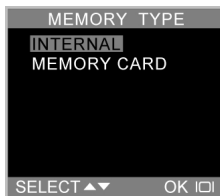

4. Use the Up and Down (▲) / (▼) buttons to select either Internal, to use the camera's on-board memory, or Memory Card, to use an SD/MMC Card.

5. Press the Display button **|O|** to confirm your selection and return to the main Setup screen.

Language

The 3765 can display menu items in English, French, Spanish, German, Italian, Japanese and Simplified Chinese. For more on setting the language, see page 15.

Video Out

When connecting your camera to a TV you may specify the video standard used by your TV. This enables you to view images on a TV or record images on a VCR.



Select the Video Out option. Choose either NTSC or PAL, according to your hardware and region. Press the Display button **|O|** to confirm your choice.

ISO

You may specify the camera's ISO light sensitivity. Two ISOs are available:

ISO 100: For shooting in bright sunlight

ISO 200: For general use in most situations



Opening

You can choose to display the welcome screen when the camera is turned on.



To turn the welcome screen on or off, scroll down to the Opening option, press the Display button **|****|**, select Yes or No, and press **|****|** to confirm.

PC Camera Mode



The 3765 camera can be used with most commercially available video software as a video camera. Simply connect it to your PC with the supplied USB cable, turn the Mode dial to PC Camera and then it turn on.







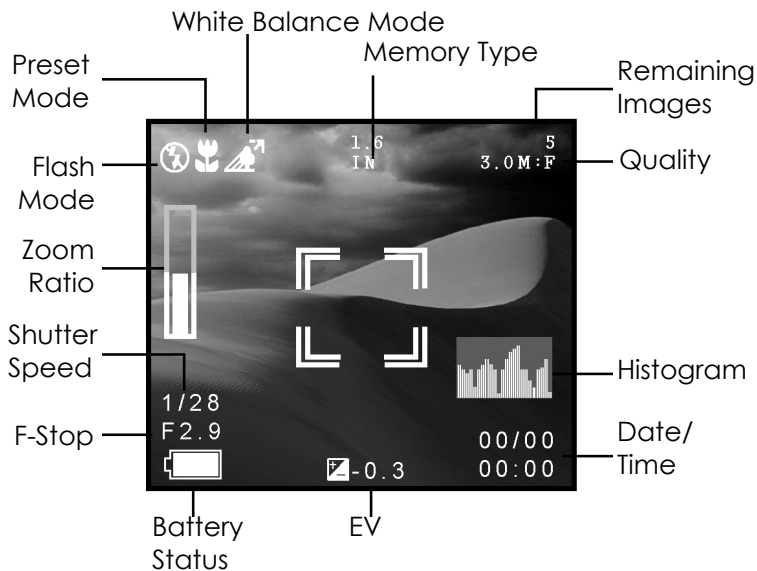

For more information regarding this mode, see Section 4.

Chapter 6 - the LCD Display





The icons on the LCD display indicate the status of camera settings and functions such as quality, zoom ratio, and number of images. This chapter describes the LCD display icons and their meanings.





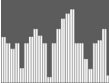

LCD Icon Descriptions

Icon	Name	Description
(None)	Auto Flash	The camera determines whether the flash is needed by detecting the amount of ambient light.
	Flash Off	Flash is turned off, regardless of the amount of light available.
	Red-Eye Reduction	Use the Red-Eye Reduction function to reduce the occurrence of "red-eye" (eyes appear red in the images due to flash reflection off the eyes' retinas.) This function causes the camera to pre-flash quickly before the image is captured to reduce red-eye. The use of flash is automatically determined by the camera.
	Flash On	Flash is always on, regardless of light available.
	Capture Mode	Indicates the camera is in Capture mode (the most common mode for capturing images.)
	Self-Timer	Indicates the camera is using the Self-Timer preset. Pressing the Shutter button will initiate the 10-second countdown timer before capturing a image.
	Playback Mode	Indicates the camera is in Playback mode. This mode is used to view images stored in internal or card memory.
	Zoom	Indicates the level of zoom currently applied. In Video Mode, optical zoom must be adjusted before recording; digital zoom can be adjusted during from 1x to 2x. In Capture Mode, optical zoom ranges from 1x to 3x and digital zoom from 1x to 4x. In Playback Mode zoom can be adjusted from 1x to 8x.
	Battery Indicator	Indicates the level of battery power remaining.

V3765 Digital Camera User's Manual

	White Balance	Indicates the current White Balance setting. The default setting is Automatic
(None)	Auto WB	The camera automatically determines the White Balance setting.
	Daylight	Use this setting when capturing images in bright daylight, to reduce the effect of "whitewashed" images.
	Shade	Use this setting when capturing images in shade, or any time your images come out too dark.
	Tungsten	Use this setting for capturing images under tungsten or incandescent light.
	Fluorescent	Use this setting for capturing images under fluorescent light.
	Histogram	This graphically shows the distribution of brightness in an image. This information can be used to judge the exposure quality.

Appendix 1 – Button Function Guide

Mode	Shutter	Up	Down	Display	Strobe/ Copy	WB/ Delete	Zoom Out	Zoom In
 Capture	Single Capture	EV+	EV-	LCD + Light → LCD Off	Auto → On → Off → Red-Eye Reduction	Auto → Day light → Shade → Tungsten → Fluorescent	Zoom Out	Zoom In
PRE SET Preset	Single Capture	Select Landscape, Portrait, Night Scent, Self-Timer or Macro	Select Landscape, Portrait, Night Scent, Self-Timer or Macro	LCD + Light → LCD Off	Auto → On → Off → Red-Eye Reduction	Auto → Day light → Shade → Tungsten → Fluorescent	Zoom Out	Zoom In
 Playback	Select Image	Page Up	Page Down	LCD + Light → LCD Off	Copy image to / from Internal / External	Delete	Zoom Out	Zoom In
 Video	Start / Stop Recording	EV+	EV-	LCD + Light → LCD Off	N/A	Auto → Day light → Shade → Tungsten → Fluorescent	Zoom Out	Zoom In
 PC Camera	N/A	N/A	N/A	N/A	N/A	N/A	N/A	N/A
SET UP Setup	Execute Function	Select	Select	N/A	N/A	N/A	Select	Select
N/A = Not Available								

Appendix 2 – Troubleshooting Guide

Problem	Possible cause	Solution
The camera has no power.	The camera is turned off.	Press the power button to turn the camera ON.
	The batteries are discharged.	Replace the batteries with fresh ones. Refer to Inserting Batteries.
	The batteries are inserted incorrectly.	Check the battery orientation. Refer to “Inserting the Batteries.”
The camera won't capture an image.	Ensure the green Camera-Ready LED indicator is on (not flashing.)	If the light is flashing, wait until it is a steady green before capturing a image. The camera may be waiting for the flash to charge.
	Is the camera connected to a computer?	The camera's buttons are not functional when connected to a PC. Disconnect the camera to restore control to the camera buttons.
The flash doesn't work.	Is the flash on?	Ensure the flash is set to auto or on. Refer to Setting the Flash.
	The batteries may be weak.	If the batteries are too weak, the flash will be unable to recharge. Turn the camera off and wait a few seconds before turning it back on. If this doesn't work, replace the batteries.
The images are blurry.	The camera or subject was moving when the shot was captured.	Hold the camera steady or put it on a tripod to capture images.
The computer does not recognize the camera. (Windows 98)	The camera was connected to PC computer before installing USB driver software.	Connect the camera to the computer with the USB cable. Select [My computer] > [Control panel] > [System] > [Device manager]. From [other devices] delete [Composite USB device] or [unknown device]. Disconnect the camera from the computer, install the software, and then reconnect the camera.

Appendix 2 – Troubleshooting Guide

<p>When using Windows ME or 2000 I get a message: "Unsafe Removal Device Detected" whenever the USB cable is unplugged from the PC</p>	<p>When removing USB devices, it is recommended that users follow the "Safe Removal of USB Device" procedure.</p>	<p>Procedure:</p> <ul style="list-style-type: none">A. Right-click the Unplug or Eject hardware icon at the bottom-right of your computer screen.B. Left-click the Unplug or Eject hardware text box to open the 'Unplug or Eject Hardware' screen.C. From the 'Unplug or Eject Hardware' screen, select the device to be disconnected and then click the Stop button to bring up the 'Stop a Hardware device' confirmation screen.D. From the 'Stop a Hardware device' confirmation screen select the device to be stopped and click OK to bring up the 'Safe To Remove Hardware' confirmation.E. Disconnect the Digital Camera from your PC.
<p>Images lose formatting data during image capture in "PC Camera" mode.</p>	<p>If your hard disk's DMA setting is turned off images may lose formatting data during image capture. (Windows 98 and ME only.)</p>	<p>Please check to make sure your hard drive's DMA setting is enabled, as follows:</p> <ul style="list-style-type: none">1. From the Windows Start menu, select Settings, then Control Panel.2. In the Control Panel double-click System, then click the Device Manager tab.3. Select your hard drive from the list, then click Properties.4. Click the Settings tab.5. Make sure the box marked DMA is checked. If not, check the box to ensure that your hard drive will protect image attributes during capture.

Free Manuals Download Website

<http://myh66.com>

<http://usermanuals.us>

<http://www.somanuals.com>

<http://www.4manuals.cc>

<http://www.manual-lib.com>

<http://www.404manual.com>

<http://www.luxmanual.com>

<http://aubethermostatmanual.com>

Golf course search by state

<http://golfingnear.com>

Email search by domain

<http://emailbydomain.com>

Auto manuals search

<http://auto.somanuals.com>

TV manuals search

<http://tv.somanuals.com>