Vivitar®

Vivicam 3625 User Manual



English

030211

FCC STATEMENT

This device complies with Part 15 of the FCC Rules. Operation is subject to the following two conditions:

- (1) this device may not cause harmful interference, and
- (2) this device must accept any interference received, including interference that may cause undesired operation

Note: This equipment has been tested and found to comply with the limits for Class B digital devices, pursuant to Part 15 of the FCC rules. These limits are designed to provide reasonable protection against harmful interference in a residential installation. This equipment generates, uses and can radiate radio frequency energy and, if not installed and used in accordance with the instructions, may cause harmful interference to radio communications. However, there is no guarantee that interference will not occur in a particular installation. If this equipment does cause harmful interference to radio or television reception, which can be determined by turning the equipment off and on, the user is encouraged to try to correct the interference by one or more of the following measures:

- Reorient or relocate the receiving antenna.
- Increase the separation between the equipment and receiver.
- Connect the equipment into an outlet on a circuit different from that to which the receiver is connected.
- Consult the dealer or an experienced radio/TV technician for help.

Use of shielded cable is required to comply with Class B limits in Subpart B of Part 15 of the FCC rules.

Do not make any changes or modifications to the equipment unless otherwise specified in the manual. If such changes or modifications should be made, you could be required to stop operation of the equipment.

この装置は、情報処理装置等電波障害自主規制協議会（VCCI）の基準に基づくクラスB情報技術装置です。この装置は、家庭環境で使用することを目的としていますが、この装置がラジオやテレビジョン受信機に近接して使用されると、受信障害を引き起こすことがあります。
取扱説明書に従って正しい取り扱いをして下さい。

TRADEMARK INFORMATION

- Microsoft® and Windows® are U.S. registered trademarks of Microsoft Corporation.
- Pentium® is a registered trademark of Intel Corporation.
- Macintosh is a trademark of Apple Computer, Inc.
- SD™ is a trademark.
- PhotoSuite, PhotoVista and the MGI logo are trademarks or registered trademarks of MGI Software Corp.
- Adobe, the Adobe logo, and Acrobat are trademarks of Adobe Systems Incorporated.
- Other names and products may be trademarks or registered trademarks of their respective owners.

E

READ THIS FIRST

Please start by reading the important messages below first.

1. The bundled driver, software, design, specifications and user's manual that packaged with the camera are subject to change without notice.
2. The accessories that come with the camera may vary between regions.
3. For driver update, you can contact the dealer who you purchased the camera from for help.
4. We are not liable whatsoever for any compensation arising from errors in descriptions in this user's manual.

WARNINGS

- Do not use the camera if it is emitting smoke, becomes unusually hot to be touched, emitting any unusual odor or noise, or if it is in any other abnormal states. Operating the camera in any of these situations may cause a fire or an electrical shock. Stop using the camera immediately, turn the camera off, and then disconnect the power source (batteries or AC power adapter). (If you are using the AC power adapter, unplug the adapter from the AC power outlet after you have disconnected the camera.) After checking that smoke is no longer being emitted, contact your dealer or your local authorized service facility and request repairs. Never attempt to repair the camera yourself as this is dangerous.
- Do not use the camera if any foreign objects have entered the camera. Turn the camera off, and then disconnect the power source (batteries or AC power adapter). (If you are using the AC power adapter, unplug the adapter from the AC power outlet after you have disconnected the camera.) Then contact your dealer or your local authorized service facility. Do not continue to use the camera as this may cause a fire or an electrical shock.
- If the camera has been dropped or if the camera case has been damaged, turn the camera off, and then disconnect the power source (batteries or AC power adapter). (If you are using the AC power adapter, unplug the adapter from the AC power outlet after you have disconnected the camera.) Then contact your dealer or your local authorized service facility. Do not continue to use the camera as this may cause a fire or an electrical shock.
- Do not place the camera in any unstable locations such as on a wobbly table or sloping surface where the camera may fall or tip over and cause injury.
- Do not expose the camera to moisture and make sure that there is no water getting into the camera. Take particular care when using the camera under extreme weather conditions such as rain or snow, or when operating the camera at the beach or near water. Water in the camera may cause a fire or an electrical shock.
- Do not attempt to modify the camera. This may cause a fire or an electrical shock.
- Do not remove the camera casing. This may cause an electrical shock. Internal inspection, maintenance and repairs should only be carried out by your dealer or local authorized service facility.
- Do not touch the power plug during a thunderstorm if you are using the AC power adapter. This may cause an electrical shock.

CAUTIONS

- Do not place the camera in damp or dusty locations. This may cause a fire or an electrical shock.
- Do not place the camera in a location affected by oil fumes or steam, such as near a cooking stove or humidifier. This may cause a fire or an electrical shock.
- Exposure to high temperatures may adversely affect the camera case and internal components and may cause a fire.
- Do not cover or wrap the camera or the AC power adapter with a cloth or quilt. This may cause heat to build up and distort the case and cause a fire. Always use the camera and its accessories in well-ventilated locations
- Handle the camera carefully and do not bump the camera into any hard object. Handling the camera roughly may cause a malfunction.
- Do not move the camera while it is switched on. (If you are using the AC power adapter, unplug the adapter from the AC power outlet after you have switched off the camera.) Ensure that any connector cords or cables to other devices are disconnected before moving the camera. Failure to do so may damage the cords or cables and cause a fire or an electrical shock.
- When leaving the camera unused for long periods, such as during a vacation, always unplug the camera from the power source (batteries or AC power adapter) for safety. (If you are using the AC power adapter, unplug the adapter from the AC power outlet after you have disconnected the camera.) Failure to do so could result in a fire.
- Do not use batteries other than those specified for use with the camera. The use of unsuitable batteries may result in the batteries splitting or leaking and causing a fire, injury, or soiling of the battery compartment.
- When fitting batteries into the camera, check the polarity markings on the battery (- and +) to ensure that you insert the battery correctly. Incorrect battery polarity may result in the batteries splitting or leaking and causing a fire, injury, or soiling of the battery compartment.
- Remove the batteries if the camera will not be used for an extended period of time. The batteries may leak and cause a fire, injury or soiling of the battery compartment. If the batteries leak, clean and wipe the battery compartment carefully and install new batteries. Wash your hands carefully if you touch the battery fluid.

CONTENTS

INTRODUCTION	7
Overview	7
Package contents	7
Common (Optional) Accessories	7
GETTING TO KNOW	
THE CAMERA	8
Front view	8
Rear view	9
Mode dial	10
LED indicators	10
Status LCD	11
LCD monitor information	12
GETTING STARTED	13
Installing the batteries	13
Using the AC power adapter ..	13
Loading a SD memory card	14
Attaching the strap	14
Choosing the language	15
Setting the date and time	15
Setting the image resolution and quality	16
RECORD MODE	17
Taking pictures	17
Using the viewfinder	17
Using the LCD monitor	18
Using the normal mode	18
Using the digital zoom	19
Using the self-timer	20
Using the macro mode	21

Using the flash	21
Taking pictures manually	23

PLAYBACK MODE	24
Viewing images	24
Zoom Playback	25
Displaying thumbnail images ..	26
Slideshow display	26
Deleting images	27

MOVIE MODE	28
Recording video clips	28
Viewing video clips	29

TRANSFERRING RECORDED IMAGES TO YOUR COMPUTER	30
--	-----------

Step 1: Installing the USB driver on Windows computers	31
Installing the USB driver on Macintosh computers	31
Step 2: Connecting the camera to your computer	31
Step 3: Downloading images/video clips	32
For computers running Windows ..	32
For computers running Mac OS	32

INSTALLING MGI PHOTOSUITE	33
INSTALLING MGI PHOTOVISTA	34

INSTALLING

ACROBAT READER 35

USING THE USER'S

MANUAL 36

MENU OPTIONS 37

Record menu 37

LCD BRIGHTNESS 37

QUICK VIEW 37

DIGITAL ZOOM 37

WHITE BALANCE 37

EV COMPENSATION 38

SHARPNESS 38

EXIT 38

Playback menu 39

LCD BRIGHTNESS 39

SLIDE SHOW 39

COPY TO CARD 39

DELETE ALL 39

DPOF 40

EXIT 40

Movie menu 41

LCD BRIGHTNESS 41

EXIT 41

Setup menu 42

DATE/TIME 42

LANGUAGE 42

SOUND 42

FORMAT MEDIA 42

VIDEO MODE 43

AUTO POWER OFF 43

RESET TO DEFAULT 44

CONNECTING THE CAMERA

TO OTHER DEVICES 45

CAMERA SPECIFICATIONS

..... 46

INTRODUCTION

Overview

Your new digital camera delivers high quality, 1600x1200 resolution images using a 2.1 Mega pixel CCD imager. Using either the optical viewfinder or the 1.6" TFT color image LCD monitor, you can compose images and then examine them in detail. An auto-flash sensor automatically detects the shooting (lighting) conditions and determines whether the flash should be used. This feature helps ensure that your images turn out right.

8MB internal (built-in) memory lets you capture and store images without the need for an additional memory card. However, you may wish to expand the memory capacity (up to 128MB capacity) by using an external memory card.

In addition to still images, you can record short videos using the movie function. Images you have taken can be downloaded to your computer using the USB cable (USB driver required for Win98 and Mac OS 8.6) You can enhance and retouch your images on your computer by using the provided editing software, or image editing software you may already own. You may share your images with your friends via e-mail, in a report, or on a website.

DPOF functionality allows you to print your images on a DPOF compatible printer by simply inserting the memory card.

E

Package contents

Carefully unpack your package and make sure that you have the following items.

Common Product Components:

- Digital camera
- Video cable
- User's manual
- USB cable
- Software CD-ROM
- Camera strap

Common (Optional) Accessories:

- SD memory card
(up to 128MB capacity)
- Camera pouch
- AC power adapter
- 2 x AA alkaline batteries

GETTING TO KNOW THE CAMERA

Front view

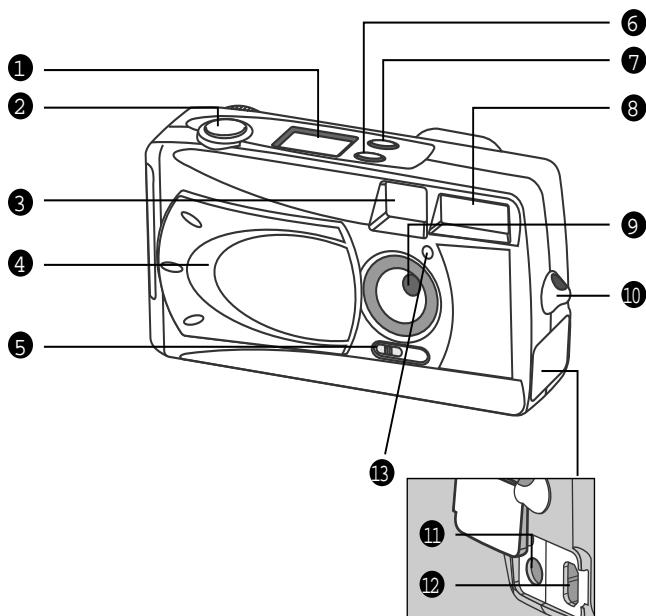

- 1. Status LCD
- 2. Shutter button
- 3. Viewfinder window
- 4. Lens cover
- 5. Focus switch
- 6. Flash button
- 7. Quality/Resolution button

- 8. Flash
- 9. Lens
- 10. Strap eyelet
- 11. DC IN jack
- 12. USB connector
- 13. Self-timer lamp

Rear view

1. ▲ Arrow button (up)
2. ◀ Arrow button (left)
- ⏱ Self-timer button
3. OKOK button
- 🔍 Digital zoom button
4. ▶ Arrow button (right)
5. ▼ Arrow button (down)
- 🗑 Delete button

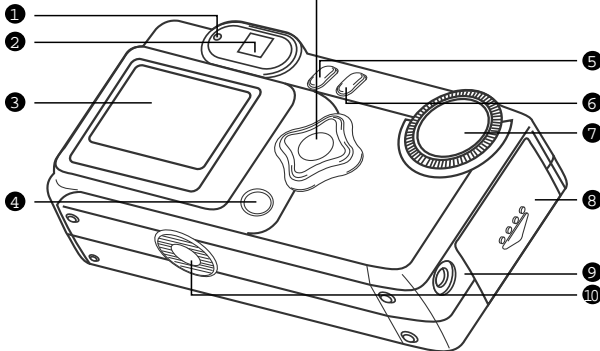
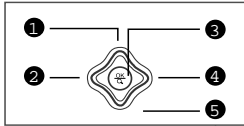



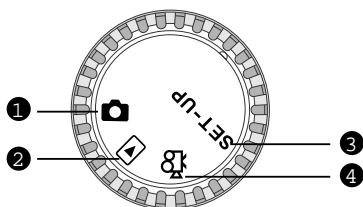

1. LED indicator
2. Viewfinder
3. LCD monitor
4. LCD button

5. ☰ Menu button
6. ⏻ Power button
7. Mode dial
8. Battery/SD card cover
9. VIDEO OUT jack
10. Tripod socket

Mode dial



1. Record mode
2. Playback mode
3. Setup mode
4. Movie mode

Mode	Description
 Record Mode	Use this mode to capture still images.
 Playback mode	Use this mode to view images & videos, delete images & video clips, view a slide show, view thumbnail displays.
SET-UP  Setup mode	Use this mode to adjust camera settings.
 Movie mode	Use this mode to record video (movie) clips.

LED indicators

Indicator	Status	Description/Activity	Sound
LED Indicator	Solid red	The camera is powering up.	No
LED Indicator	Blinking red	Camera system error	Yes *(3)
LED Indicator	Solid orange	Charging the flash	No
LED Indicator	Blinking orange	Image is being recorded to the memory card.	No
LED Indicator	Blinking orange	USB communication/transfer in progress	No
LED Indicator	Solid green	The camera is ready to record images (or movies).	Yes *(1)
Self-timer Indicator	Blinking red	The self-timer function is activated.	Yes *(1)
—	—	Error message	Yes *(3)
—	—	Valid button event	Yes *(1)

*(3) The camera sounds three beeps.

*(1) The camera sounds one beep.

Status LCD

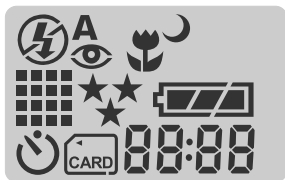

Flash mode

- Auto flash
- Red-eye reduction
- Fill flash (on)
- Flash off
- Slow synchro

Image resolution

- 1600 x 1200 pixels
- 800 x 600 pixels
- Self-timer mode
- Card indicator

Image quality

- Fine
- Normal
- Basic
- Macro mode

Battery check

- Full battery power
- Medium battery power
- Low battery power
- Virtually No battery power

E

00:00

Digital indicator (This display varies according to the camera mode setting.)

Displays the estimated shots that you can take in Record mode .

Displays the estimated seconds that you can record for the video clip in Movie mode .

Displays the current number of the recorded image in Playback mode .

Displays "PC" when connecting the camera to your computer by using the USB cable.

LCD monitor information

The displayed indicators when recording still images:



E The displayed indicators when recording video clips:

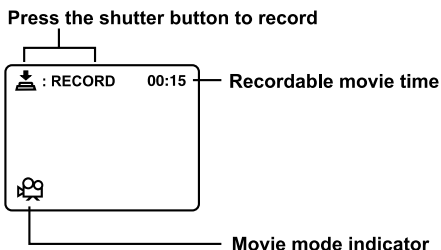

The displayed indicators when playing images back:



The displayed indicators when playing video clips back:

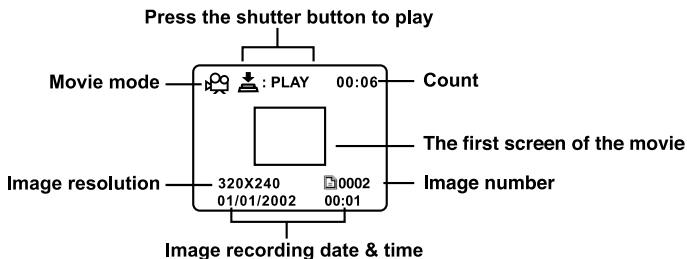

GETTING STARTED

You can use either 2 AA size batteries (Alkaline, Ni-MH) or an AC power adapter (optional accessory) to power the camera. Battery power is convenient for recording images or video clips while AC adapter power is recommended for transferring images to your computer.

Installing the batteries

1. Make sure the camera is off.
2. Slide the battery/SD card cover in the direction of the OPEN arrow.
3. Insert the batteries according to the correct polarity marks (+ or -).
4. Close the battery/SD card cover firmly.

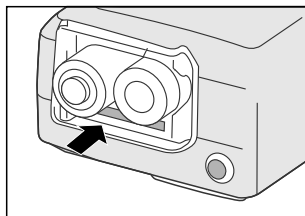

E

NOTE

- If you won't be using the batteries for an extended period of time, remove them from the camera to prevent leaks or corrosion.
- Never use manganese batteries.
- Never use different types of batteries (together) or mix old and new batteries.
- Avoid using batteries in extremely cold environments as low temperatures can shorten the battery life and reduce camera performance.

Using the AC power adapter (optional accessory)

1. Make sure the camera is off.
2. Open the DC IN jack cover and connect one end of the AC power adapter to the DC IN jack on the camera.
3. Connect the other end to an electrical outlet.

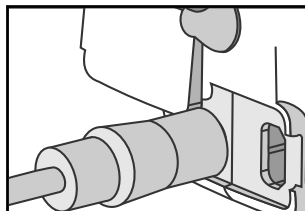

NOTE

- Make sure to use only the specified AC power adapter for the camera. Otherwise, it may cause damages to the camera, which is not covered under the warranty.
- To prevent unexpected auto power off resulting from no battery power left during the process of transferring your images to the computer, use the AC power adapter as a power supply.

Loading a SD memory card (optional accessory)

The camera comes with 8MB of internal memory, allowing you to store images and video clips in the camera. However, you can expand the memory capacity by using an optional SD memory card so that you can store additional images and video clips.

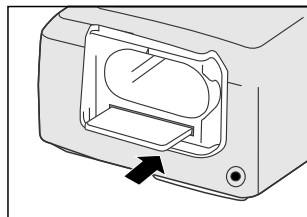

1. Make sure the camera is off.
2. Slide the battery/SD card cover in the direction of the OPEN arrow.
3. Insert the SD memory card.
 - The front side of the memory card (printed arrow) should face towards the front side of the camera.
 - If the card cannot be inserted, check the orientation.
4. Close the battery/SD card cover.
 - To remove the SD memory card, make sure the camera is off. Open the battery/SD card cover. Press lightly on the edge of the memory card and it will eject.



NOTE

- To prevent valuable data from being accidentally erased from an SD card you can slide the write protect tab (on the side of the SD memory card) to "LOCK".
- To save, edit, or erase data on an SD memory card, you must unlock the card.

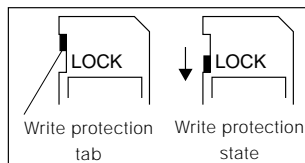

Attaching the strap

To prevent accidental dropping of the camera, always use the strap.

1. First thread the small loop of the wrist strap through the strap eyelet on the camera and then pull the large loop through the small loop until the strap is firmly secured.

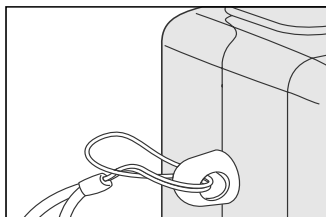

Choosing the language

When you first turn the camera on, the language setting screen appears, prompting you to choose a language for displayed information on the LCD monitor. Follow the steps below to set the OSD (On-Screen Display) language.

1. Select a language that you prefer by using the ▲ / ▼ button.
2. Press the OK button to confirm.



NOTE

- The language setting will be retained even if the camera is turned off.

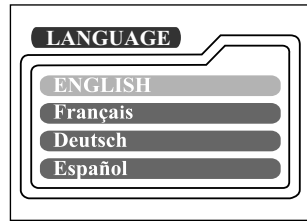

E

Setting the date and time

The Date/Time screen will be presented if/when:

- Camera is turned on for the first time (after setting the language)
- Camera is turned on after removing or replacing the batteries.

When the date and time setting screen appears, follow these steps to set the correct date and time. You may skip this procedure by pressing the OK button repeatedly.

1. Enter the values of the year, month, day and time fields by using the ▲ / ▼ / ◀ / ▶ button. Press the OK button after each field is set.
 - To increase a value, press the ▲ / ▶ button.
 - To decrease a value, press the ▼ / ◀ button.

Setting the image resolution and quality





















































Resolution and quality settings determine the pixel size (dimension), image file size, and compression ratio for your images. These settings affect the number of images that can be stored in memory, or on an SD memory card. As you get to know the camera, it is recommended that you try each quality and resolution setting to get an appreciation for the effects that these settings will have on your images.

Higher resolution and higher quality images offer the best photographic results but produce large file sizes. Therefore, fewer images will take up more memory space.

E

High resolution and quality settings are recommended for printed output and situations requiring the finest detail. Lower resolution/quality images take up less memory space and may be quite suitable for sharing images via e-mail, in a report, or on a web page. To change image resolution and quality settings, press the  button on top of the camera repeatedly to select the settings that you prefer. As you press this button watch the Status LCD.

Resolution & Quality:



The camera provides 2 resolution modes and 3 quality modes, which can be changed cyclically by pressing the  button. The cyclical order is                                                    

RECORD MODE

Taking pictures

Your camera is equipped with both an optical viewfinder and a 1.6" LCD monitor to compose images. Taking images using the optical viewfinder will conserve battery power. If your batteries are low, it is recommended that you only compose images by using the viewfinder. Using the LCD monitor you can compose images more accurately, but at the cost of battery consumption. Always use the image LCD for macro shots, however, to avoid parallax effects. The LCD image display must be used when Digital Zoom is used.

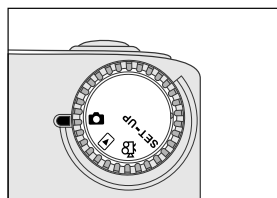

Using the viewfinder

1. Open the lens cover.
2. Turn the mode dial to the  mode.
3. Turn the camera on by pressing the  button.
4. Compose your shot in the viewfinder.
5. Press the shutter button down halfway (the camera adjusts the exposure and the focus), then press it the rest of the way down.
 - When the camera adjusts the exposure and focus, the LED indicator lights red. Take a picture until the LED indicator lights green.
 - The LED indicator blinks orange while the camera is processing a captured image.



E

Using the LCD monitor

1. Open the lens cover.
2. Turn the mode dial to the  mode.
3. Turn the camera on by pressing the  button.
4. Turn the LCD monitor on by pressing the  button.
5. Compose the picture.
6. Press the shutter button.
 - The LED indicator blinks orange while the camera is processing a captured image.

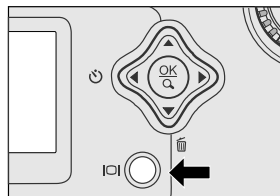



NOTE

- The image on the LCD monitor darkens when in strong sunlight or bright light. This is not a malfunction.
- Using the LCD monitor for an extended period of time will decrease the number of images you can take. To increase battery longevity, turn the LCD monitor off and use the viewfinder instead.
- Always use the image LCD for macro shots.
- The LCD monitor must be on when Digital Zoom is to be used.

Using the normal mode

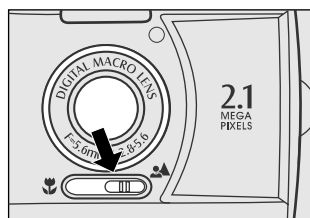

Normal mode is used to take images where the distance to the subject is 70 cm or more. Select this mode for general shooting, including portraits and scenery.

1. Open the lens cover, turn the mode dial to the  mode, and power on the camera.
2. Move the focus switch located on the front side of the camera to the  position.
3. Compose the picture.
4. Press the shutter button.



Using the digital zoom

Using digital zoom, images appear closer. Whereas digital zoom is a compelling feature, the more an image is enlarged (zoomed), the more pixilated (grainier) the image will appear. The digital zoom function is only available when you set the LCD monitor and the digital zoom to ON. To enable the digital zoom, refer to DIGITAL ZOOM in Record menu.

1. Open the lens cover, turn the mode dial to the  mode, and power on the camera.
2. Turn the LCD monitor on by pressing the  button.
3. Press the OK button to activate 2X digital zoom function.
 - The 2X icon appears on the LCD monitor.
 - To cancel the digital zoom function, press the OK button.
4. Press the shutter button to capture a "zoomed" image.





E

NOTE

- You can only set the digital zoom at the resolution of 1600x1200 pixels; digital zoom is not available at the resolution of 800x600 pixels. When you play back a "digitally zoomed" image, the image size is 800x600 pixels.
- The more the image is enlarged, the more pixilated (grainier) the image.
- Digital zoom cannot be used in the movie mode.

Using the self-timer

The self-timer duration is 10 seconds. After the activation of the self-timer by pressing the shutter button, the self-timer lamp starts blinking slowly for 7 seconds and then blinking faster for the rest of 3 seconds. This allows you to get into the scene when taking group images.

1. Secure the camera to a tripod or place it on a stable surface.
2. Open the lens cover, turn mode dial to the  mode, and power on the camera.
3. Press the  button.
 - The  icon appears on the LCD monitor and status LCD.
4. Compose the picture.
5. Press the shutter button.
 - The self-timer function is activated.
6. After ten seconds, the camera takes an image.
 - To cancel self-timer photography at any time, press the shutter button to disrupt the sequence.

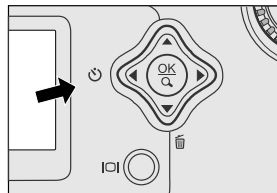

E





NOTE

- After one shot is taken, the self-timer mode is turned to off.

Using the macro mode

Use the macro mode to shoot a close-up of the subject, such as flowers or insects. The effective range is between 30cm and 80cm.

1. Open the lens cover, turn the mode dial to the  mode, and power on the camera.
2. Move the focus switch located on the front side of the camera to the  position.
 - The  icon appears on the LCD monitor and status LCD.
3. Compose the picture.
4. Press the shutter button.
 - To disable macro photography, slide the focus switch back to normal.

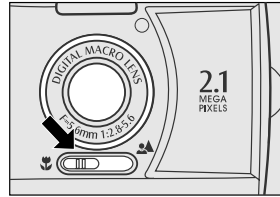



NOTE

- When shooting a close-up in macro mode, use the image LCD monitor to compose your shot, avoiding the off-center parallax phenomenon.
- There is not a distinct point (subject range) at which normal mode is favored over macro mode; take in image in both optical modes and compare the results.
- After a macro shot is taken DO NOT FORGET to reset the lens to the normal position.



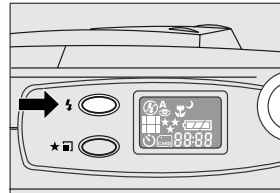

Using the flash

The flash is designed to function automatically when lighting conditions warrant the use of flash. You can take an image using a flash mode suitable to your circumstances. If you change the flash mode, the camera will retain that setting even if the camera is turned off.

1. Open the lens cover, turn the mode dial to the  mode, and power on the camera.
2. Press the  button located on top of the camera repeatedly until your desired flash mode appears.
3. Compose the picture and press the shutter button.









The camera has five flash modes: Automatic Flash (default), Red-Eye Reduction, Fill flash (on), Flash Off and Slow Synchro. The modes appear, cyclically, when you press the flash button on top of the camera. The table below will help choose the appropriate flash mode:

Flash Mode	Description
[] Auto Flash	The flash fires automatically according to the ambient conditions. Select this mode for general photography.
[] Red-eye Reduction	The flash emits a precursor-flash before the main flash fires. This causes the pupil in the human eye to constrict, reducing the red-eye. Select this mode when taking pictures of people and animals in low-light conditions.
[] Fill Flash (on)	The flash will always fire regardless of the surrounding brightness. Select this mode for recording images with high contrast (backlighting) and deep shadows. Also known as forced flash.
[] Flash Off	The flash will not fire. Select this mode when taking images in a place where flash photography is prohibited, or when the distance to the subject is beyond the effective range of the flash.
[] Slow Synchro	The flash fires and the shutter speed is reduced so that the subject will be exposed correctly while taking a image with dark (night) background.

Taking pictures manually

You can manually adjust conditions such as white balance, EV compensation and sharpness when taking pictures. For white balance, EV compensation and sharpness information, refer to WHITE BALANCE, EV COMPENSATION or SHARPNESS in Record menu.

To take pictures manually:

1. Turn the camera on.
2. Turn the mode dial to the  mode.
3. Press the  button.
4. Move to WHITE BALANCE, EV COMPENSATION or SHARPNESS with the  /  button.
5. Change the settings by using the  /  button and then press the OK button.
6. Compose the picture.
7. Press the shutter button.

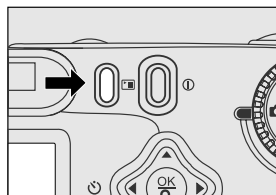





E

PLAYBACK MODE

In the  mode, you can view, magnify, delete images, play video clips, or run a slide show. Playback mode also provides a thumbnail image display, allowing you to quickly search for the image you want.

Viewing images

You may view your images without opening the lens cover since the lens is not used for playback. The camera lens is protected during playback.

1. Turn the mode dial to the  mode and power on the camera.
2. Select the image that you want to view by using the  /  button.
 - To view the previous image, press the  button.
 - To view the next image, press the  button.

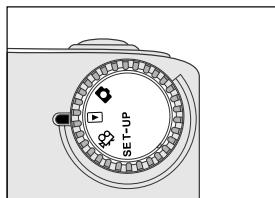







NOTE

- If there is no image stored in the internal memory or on the memory card, "ⓘ NO IMAGES" message will appear on the LCD monitor.
- You can also view your images on the TV screen. Connect one end of the video cable to the video out jack of the camera and connect the other end to the video input of your TV. Turn the mode dial to the  mode and then turn on both TV and camera.

Zoom Playback

While reviewing your images, you may enlarge a selected portion of an image. This magnification allows you to view fine details.

1. Turn the mode dial to the  mode with the camera power on.
2. Select the image that you want to view by using the   button.
3. Enlarge the image by pressing the OK button.
 - Pressing the OK button once magnifies the image to 2X. Pressing it again magnifies the image to 4X. When enlarging the recorded image, you will see a red frame with a red box inside. The red frame indicates the entire image, while the red box shows the enlarged area.
4. To view the different portion of the enlarged image, press the     button.
5. To return to the regular display from 4X-enlarged status, press the OK button twice.

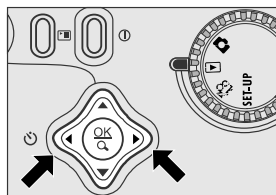

Current position of enlargement

Entire image







NOTE

- Pressing the OK button magnifies the image from 1X→2X→4X.
- Pressing the OK button reduces the image from 4X→2X→1X.

Displaying thumbnail images

This function allows you to view nine thumbnail images on the LCD monitor simultaneously so you may search for a particular image.

1. Turn the mode dial to the  mode and power on the camera.
2. Press the  button once.
 - The image information appears on the LCD monitor.
3. Press the  button again.
 - Nine thumbnail images appear on the LCD monitor (assuming there are nine or more images in memory).
 - To view a full-size image, press the OK button after selecting it by using the  /  button.

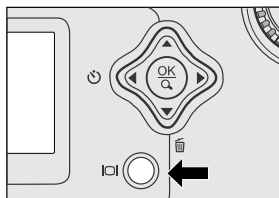









NOTE

- By pressing the  button repeatedly, the image will show as follows.
Image only → Image and OSD (on-screen display) → Thumbnail image display



Slideshow display

The slideshow function enables you to playback your images back automatically in sequential order as a slide show. This is a very useful and entertaining feature for reviewing recorded images and for presentations.

1. Turn the mode dial to the  mode and power on the camera.
2. Press the  button and move to SLIDE SHOW by using the  /  button.
3. Set the playback interval by using the  /  button and then press the OK button.
 - The slideshow starts, displaying your images on the LCD monitor, one by one, at the set interval.
 - To stop the slideshow display, press the OK /  /  /  button.







NOTE

- You can adjust the slideshow display interval within the range of 2 sec. to 10 sec. For interval setting, refer to SLIDE SHOW in the Playback menu.

Deleting images

You can delete one image/video clip by pressing the  button.

To delete one image at a time:

1. Select the image/video clip you want to delete by using the /  button. And then press the  button.
2. Select [YES], and then press the OK button. The next image/video clip appears.
 - If you want to cancel the deletion, select [NO].
3. Continue the deletion if necessary. If all images are deleted, [ NO IMAGES] pops up. To exit this function, turn the mode dial to any other mode.

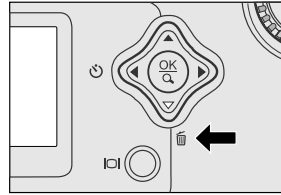

E



NOTE

- To delete the images or video clips stored in the internal memory, remember not to insert the memory card in the camera. Otherwise, you will delete the images or video clips stored in the memory card.

MOVIE MODE

Recording video clips

The movie mode allows you to record video clips at the resolution of 320 x 240 pixels.

1. Open the lens cover, turn the mode dial to the  mode, and power on the camera.
 - The recordable movie time displays on the status LCD and the LCD monitor.
2. You can start recording a video clip by pressing the shutter button.
 - The elapsed time displays on the LCD monitor while recording a video clip.
 - To stop recording, press the shutter button again.

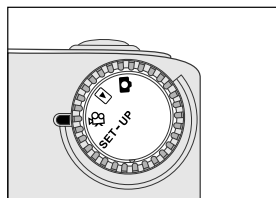

E







NOTE

- In movie mode, resolution/quality, macro, self-timer cannot be set or activated.
- In movie mode, the flash mode is automatically set to [OFF].

Viewing video clips

To view the recorded video clips, follow the steps below.

1. Turn the mode dial to the  mode and power on the camera.
2. Select the video clip that you want to view by using the   button.
3. Press the shutter button to start.
 - To pause playback at any time, press the shutter button again.
 - To stop playback, press the  button.

Pressing the shutter button or the  button while playing back the video clip will change the status as follows:

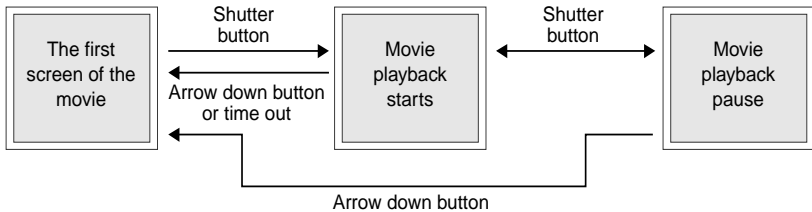

NOTE

- The zoom function cannot be activated while playing the video clip back.
- To play the video clip back on the computer, we recommend that you use the "Quick Time Player". This software is free of charge, compatible for Mac and Windows-based computers and can be downloaded from the Web site at www.apple.com. For Quick Time Player usage, please refer to its on-line help for more information.

TRANSFERRING RECORDED IMAGES TO YOUR COMPUTER

You can share recorded images/video clips with your family or friends via e-mail or post them on the Web. Before doing those things, you need to connect the camera to your computer by using the USB cable and then transfer the images/video clips.

To transfer images/video clips from the camera to your computer, follow the steps below.

Step 1: Installing the USB driver

Step 2: Connecting the camera to your computer

Step 3: Downloading images/video clips

E

	System requirements (Windows)	System requirements (Macintosh)
CPU	Pentium 166 MHz processor or higher	PowerPC G3/G4
OS	Windows 98/98SE/Me/2000/XP	OS 8.6 or later
Memory	32MB RAM (64MB recommended)	32MB RAM (64MB recommended)
Free Space on Hard Disk	128 MB hard disk space	128 MB hard disk space
Required Devices	A CD-ROM drive, An available USB port	An available USB port A CD-ROM drive,
Color Monitor	Color monitor (800x600, 24-bit or higher recommended)	Color monitor (800x600, 24-bit or higher recommended)

Step 1: Installing the USB driver on Windows computers

The USB driver on the supplied CD-ROM is exclusively for Windows 98. Installing the USB driver on computers running Windows 2000/ME/XP is not necessary.

1. Insert the CD-ROM packaged with the camera into the CD-ROM drive. The welcome screen appears.
2. Click "Install USB Driver". Follow the on-screen instructions to complete the installation. After the USB driver installation is complete, restart your computer.

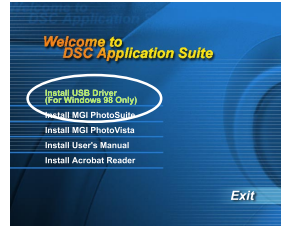

Installing the USB driver on Macintosh computers

Mac OS 8.6 users must install a USB driver. For Mac OS 9.0 or higher, the computer will automatically recognize the camera and load its own USB drivers.

1. Insert the CD-ROM packaged with the camera into the CD-ROM drive.
2. Select and double-click "Digital Camera Driver Installer".
3. Select "Install Location" and click "Install".
4. Follow the on-screen instructions to complete the installation and restart your computer.

Step 2: Connecting the camera to your computer

1. Connect one end of the USB cable to an available USB port on your computer.
2. Connect the other end of the USB cable to the USB connector on the camera.
3. Turn the camera on.
 - "PC" appears on the status LCD.
4. Look for a new "removable disk" appearing in the "My Computer" window. Your recorded images/video clips will be in a folder on this "removable disk". (For Mac users, double-click the "untitled" disk drive on the desktop.)

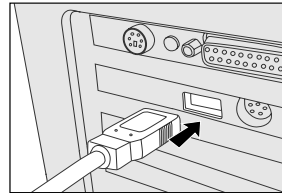

Step 3: Downloading images/video clips

When the camera is turned on and connected to your computer, it is considered to be one disk drive. You can download images/video clips by copying them from the "removable disk" ("untitled" disk on a Macintosh) to your hard drive or to another kind of disk.

For computers running Windows

Open the "removable disk" by double clicking on it. Double click on the folder. Your images are inside the folder(s). Select the images that you want, then choose copy from the Edit menu. Open the destination location and choose Paste from the Edit menu. You may also drag and drop image files from the camera to a desired location.

E

For computers running Mac OS

Open the "untitled" disk window and the hard disk or the destination location. Drag and drop from the camera disk to the desired destination.



NOTE

- It is recommended that you use the AC power adapter as a power supply for the camera while transferring images/video clips from the camera to your computer since camera power may be cut off unexpectedly if the batteries run out.

INSTALLING MGI PHOTOSUITE

MGI PhotoSuite is a very user-friendly image-editing program. With PhotoSuite, you can breezily retouch, compose and organize your images. It contains a variety of templates, such as photo frames, birthday cards, calendars and more. Get your images ready and go explore this amazing program.

To install MGI PhotoSuite:

1. Insert the CD-ROM packaged with the camera into the CD-ROM drive. The welcome screen appears.
2. Click "Install MGI PhotoSuite". Follow the on-screen instructions to complete the installation.

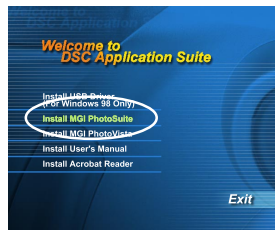

E



NOTE

- To use MGI PhotoSuite to edit and retouch your recorded images, please refer to the on-line help of this software as a guide.
- For Windows 2000/XP users, make sure to install and use the MGI PhotoSuite in the "Administrator" mode.
- PhotoSuite is not supported on the Mac.

INSTALLING MGI PHOTOVISTA

MGI PhotoVista is an easy-to-use program that lets you create spectacular 360° panoramic images in a snap. When you view these panoramas, you get the experience of being totally immersed in a realistic environment. PhotoVista's powerful engine quickly and automatically stitches images together, and its intuitive interface will let even a novice get great results in minutes.

To install MGI PhotoVista:

1. Insert the CD-ROM packaged with the camera into the CD-ROM drive. The welcome screen appears.
2. Click "Install MGI PhotoVista". Follow the on-screen instructions to complete the installation.

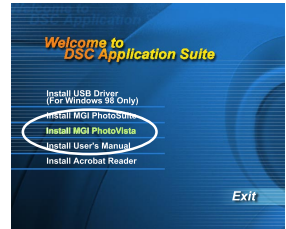

E



NOTE

- To use MGI PhotoVista to create spectacular 360° panoramic images, please refer to the on-line help of this software as a guide.
- For Windows 2000/XP users, make sure to install and use the MGI PhotoVista in the "Administrator" mode.
- PhotoVista is not supported on the Mac.

INSTALLING ADOBE ADOBE READER

The CD-ROM includes a PDF (portable document format) copy of the user manual. To view a PDF you must have Acrobat Reader installed in your computer. Acrobat Reader is included on the camera CD ROM. Using Acrobat Reader, you can read the user manual and print sections of interest.

1. Insert the CD-ROM that came with the camera into the CD-ROM drive. The welcome screen appears.
2. Click "Install Acrobat Reader". Follow the on-screen instructions to complete the installation.



For Mac users:

1. Insert the CD-ROM that came with the camera into the CD-ROM drive.
2. Select and double-click "Acrobat Reader".
3. Select and double-click the language that you want.
4. Double-click "Reader Installer".
5. Follow the on-screen instructions to complete the installation.

E

USING THE USER'S MANUAL

A copy of the user manual on is provided on the CD-ROM in PDF format. It is a backup copy of the printed manual. If you misplace the printed guide, you may print another copy from the CD ROM. The only requirement for viewing the User Manual on the CD ROM is that you have Acrobat Reader installed on your computer.

1. Insert the CD-ROM that came with the camera into the CD-ROM drive. The welcome screen appears.
2. Click "Install User's Manual". Follow the on-screen instructions to complete the installation.







For Mac users:

1. Insert the CD-ROM packaged with the camera into the CD-ROM drive.
2. Select and double-click "Manual".
3. Select and double-click the language that you want.
4. Drag and drop the PDF file from the current location to the destination location.
View the user's manual by opening it.



E

MENU OPTIONS

Record menu



You can use the record menu to change LCD brightness, change white balance, adjust EV compensation settings, etc. To do this, press the  button in the  mode. And then scroll through the options by using the  /  button.

LCD BRIGHTNESS

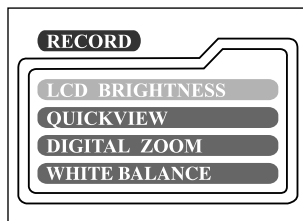
This option adjusts the brightness of the LCD monitor. Press the OK button, the LCD brightness control will appear. Press the  button to brighten the LCD monitor while press the  button to darken the LCD monitor. And then press the OK button.





QUICK VIEW

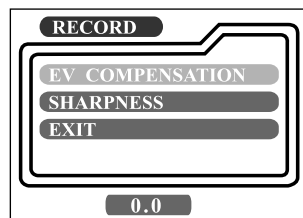

You can view each captured image on the LCD display immediately after capture by enabling Quick View. Each captured image will be displayed briefly, after which the camera returns to the  mode automatically. Set [ON] or [OFF] to enable or disable the instant review by pressing  /  button. And then press the OK button.



DIGITAL ZOOM

You can take digital zoom shots by activating the digital zoom function. Use the  /  button to enable this option if necessary. And then press the OK button.

WHITE BALANCE

Your camera adjusts the white balance of each scene automatically. However, the images that your camera captures will appear different under different lighting conditions (sun, shade, fluorescent, tungsten lights). Unlike your eyes, which can easily adjust to different lighting conditions (lighting temperatures), a digital camera cannot always differentiate between lighting types. Under some lighting conditions the image may appear in strange shades. If that occurs you may change the white balance setting by specifying a lighting condition (temperature) most appropriate for your scene. Use the  /  button to select the appropriate white balance and then press the OK button.

- [AUTO] : automatically adjusting the white balance
- [SUN] : for outdoors on a bright day
- [SHADE] : for cloudy and shady sky
- [FLUORESCENT] : for under fluorescent lighting
- [TUNGSTEN] : for under tungsten lighting

EV COMPENSATION

Your camera adjusts the exposure of each scene automatically. However, when if the subject is very dark, or very bright, you may override the camera automatic exposure determination to make the subject brighter or darker. This is called EV compensation. The EV compensation of the camera can be adjusted from -1.8EV to +1.8EV. Use the ◀▶ button to select the EV compensation that you want and then press the OK button.

Effective Subjects and Set Values

Positive (+) Compensation

- Imaging of printed text (black characters on white paper)
- Portraiture with back lighting
- Very bright scenes (such as snowfields) and highly reflective subjects
- Shots made up predominantly of sky

E

Negative (-) Compensation

- Spot lighted subjects, particularly against dark backgrounds
- Imaging of printed text (white characters on black paper)
- Scenes with low reflectivity, such as shots of green or dark foliage

SHARPNESS

This option sets the level of image sharpness. Use the ◀▶ button to select the sharpness mode that you want and then press the OK button.

[NORMAL] : leave the image detail as captured





[SOFT] : soften the edge of the image detail for special effect

[HARD] : sharpen the edge of the image detail

EXIT

This option exits the record menu and then returns to the 📷 mode. Press the OK button to exit. You can also press the 🏠 button again to exit.



Playback menu

Use the playback menu to create an on-camera slide show, configure DPOF settings, or transfer images from internal memory to a memory card. To access the playback menu, press the  button in the  mode and navigate through the options by using the  /  button.

LCD BRIGHTNESS



Refer to LCD BRIGHTNESS in Record menu.

SLIDE SHOW

Your camera can display your images sequentially as a slide show at a selected interval. Use the  /  button to select the slide interval time you desire and then press the OK button.

[2 sec], [4 sec], [6 sec], [8 sec], [10 sec]

COPY TO CARD

This feature allows you to copy your images from the camera's internal memory to an SD memory card. Of course, you can only do this if you have an SD memory card installed and some images in internal memory. Use the  /  button to select [YES] if necessary and then press the OK button.

DELETE ALL

This option allows you to delete all images/video clips the memory. If you wish to delete the images or video clips in the internal memory, ensure that the memory card is not inserted in the camera. Otherwise, you will delete the images or video clips stored in the SD memory card.

Use the  /  button to select [YES] if necessary and then press the OK button.

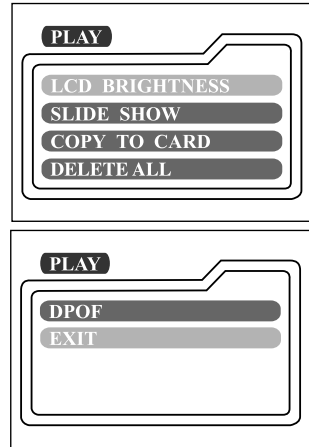

DPOF

DPOF allows you to embed printing information on your memory card. Using DPOF you can select an image to be printed and then specify how many prints to you would like. Take your memory card to a DPOF enabled printer that accepts SD memory cards. The DPOF/card-compatible printer will read the embedded information on the memory card and print your images as specified.

To use DPOF, first press the OK button to enter the DPOF sub-menu. Use the ◀/▶ button to set the values for each field and then press the OK button.

- [PRINT QUANTITY] : Select image quantity from 1–9
[PRINT SIZE] : Select your preferred image size
(standard, 3x5, 4x6, 5x7, 8x10)
[PRINT INDEX] : allows you to print the images in index format
[PRINT ENABLE] : If you select ENABLE, the camera will save the DPOF settings. If DISABLE is selected, all the settings will be erased.

E

DPOF shortcut

You can use the shutter button to quickly establish DPOF settings, as follows:

1. Turn the mode dial to the ▶ mode.
2. Press the shutter button to toggle the DPOF print tag setting for the specified image.





NOTE

- When using the shutter button to enable the DPOF setting, the default setting is size=standard, and quantity=1.

EXIT

This option exits the record menu and then returns to the ▶ mode. Press the OK button to exit. You can also press the ⏏ button again to exit.

Movie menu



To adjust movie menu setting, press the  button in the  mode and navigate to the option you wish to set by using the  /  button.

LCD BRIGHTNESS

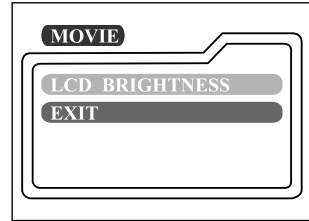
This option adjusts the brightness of the LCD monitor. Refer to LCD BRIGHTNESS in Record menu for detailed information.



EXIT

This option exits the movie menu and then returns to the  mode. Press the OK button to exit. You can also press the  button again to exit.

E

Setup menu

Select your general camera preferences in the SET-UP mode. Switch the mode dial to the SET-UP mode and navigate to the option you wish to configure by using the ▲/▼ button.

DATE/TIME

Press the OK button to enter the DATE/TIME sub-menu. Refer to section in this manual titled SETTING THE DATE AND TIME for further detail. After removing the batteries from the camera, the date and time will return to the default setting. If this happens, reset the date and time when using the camera.

[YEAR], [MONTH], [DAY], [TIME]

LANGUAGE

This option allows you to select the language for the menus and the text displayed on the LCD monitor. Press the OK button to enter the LANGUAGE sub-menu. And then select the preferred language using the ▲/▼ button and press the OK button.

[ENGLISH], [Français], [Deutsch], [Español], [Italiano], [日本語], [中國語(繁體)], [中国語(简体)]

SOUND

The camera produces a sound (beep) each time you press the camera button if this function is enabled. Select [ON] or [OFF] by using the ◀▶ button and then press the OK button.

FORMAT MEDIA

This utility formats the internal memory (or memory card) and erases all stored images and data. If you select [YES] with the ◀▶ button and press the OK button, the FORMAT MEDIA message appears on the LCD monitor. When you select [YES] and press the OK button again, a progress bar displays, showing the progress of the format. This utility formats the internal memory (or memory card) and erases all stored images and data.

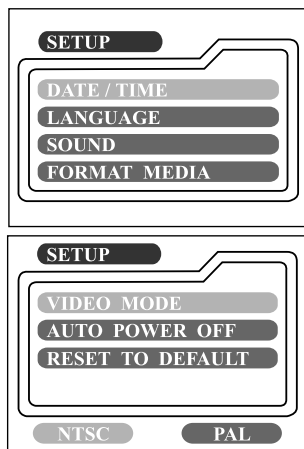

VIDEO MODE

This option allows you to view your images on a TV. Connect the camera to your TV using the video cable. Then select the video output format by using the ◀/▶ button and press the OK button.

- [NTSC] : select this format when located in the U.S.A., Canada, Japan, Korea, Taiwan, Central America, Mexico, etc.
- [PAL] : select this format when located in Australia, Austria, Belgium, China, Denmark, Finland, Germany, Great Britain, Holland, Italy, Kuwait, Malaysia, New Zealand, Singapore, Spain, Sweden, Switzerland, Thailand, Norway, etc.

AUTO POWER OFF

If there is no camera activity (no buttons are pressed) for a defined period of time while the camera is powered on, the camera will switch to an idle mode, and eventually turn itself off to conserve power.

Inactivity period (batteries)	Inactivity period (AC power adapter)	Camera status
90 seconds	90 seconds	stay idle
3 minutes	30 minutes	shut off

If the camera is idle, re-activate the camera by pressing any button or switch the mode dial. If the camera has powered-off you must to turn the camera on again by pressing the Ⓚ button. The table (above) shows the default time settings for idle, and power-off. You can change the power saving interval by using the ◀/▶ button and then press the OK button.

[3 min], [5 min], [10 min], [30 min]

RESET TO DEFAULT

If you wish to restore all camera settings to their original status, select [YES] by using the ◀▶ button and then press the OK button.

The following table shows the default setting for each item.

Item	Description
Image resolution	1600x1200 pixels
Image quality	★★ Fine
Flash	Auto
Quick view	Off
White balance	Auto
EV compensation	0.0
Slide show delay	4 seconds
Auto power off	Battery: 3 minutes AC power adapter: 30 minutes
Sound	On
Digital Zoom	Off

CONNECTING THE CAMERA TO OTHER DEVICES

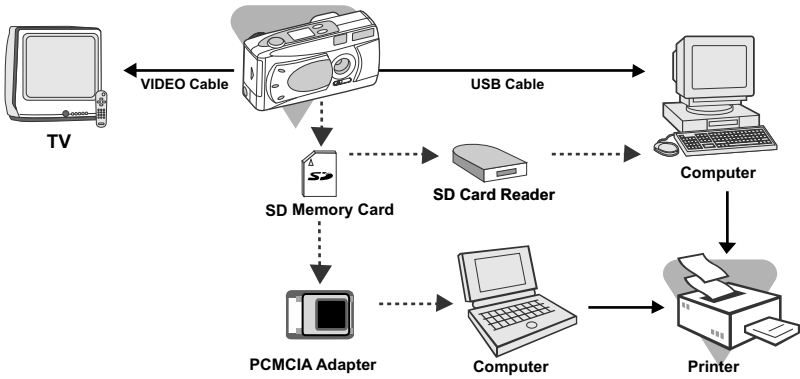

E

CAMERA SPECIFICATIONS

Item	Description
Sensor	Approx. 2.1megapixels 1/3.2" CCD
Color depth	24 bits (8 bits x 3 colors)
Resolution	1600x1200 pixels 800x600 pixels
LCD	1.6" color TFT LCD
Self-timer	10 seconds delay
Shutter speed	1/10 sec. ~ 1/500 sec.
Zoom	2 x digital zoom
Capture modes	Still photographs or video recording
Memory type	8 MB internal memory SD memory card (optional) (up to 128MB capacity)
Memory capacity	Storage for an 8MB SD memory card at 1600x1200 pixels: Fine: 10 images; Normal: 15 images; Basic: 20 images
Flash effective range	0.7m ~ 3m
Lens	Fixed focal length: 5.6mm Focal range: Standard—0.7m ~ infinity; Macro—0.3m ~ 0.8m F-number: 2.8/5.6
Focus	Focus range: 30cm to infinity
Exposure compensation	Auto; Manual: -1.8 ~ +1.8EV (0.3EV step)
White balance	Auto, Sun, Shade, Fluorescent, Tungsten
Compressed format	JPEG, Motion JPEG for video clip
Standards	JPEG, EXIF 2.1, DPOF, DCF, Motion JPEG
Interface	DC IN jack, USB connector, VIDEO OUT jack (NTSC or PAL)
Operating environment	Operation: 0°C ~ 40°C, 15 ~ 90% humidity Storage: -20°C ~ 80°C, 10 ~ 95% humidity
Power	2 AA Alkaline (1.5V) or Ni-MH (1.5V) batteries, or AC power adapter(2.5A/3.3V)
Tripod socket	Yes
Dimensions	105 x 44 x 55 mm (W x H x D) (without protruding parts)
Weight	Approx. 150g (without batteries and the SD memory card)

*Design and specifications are subject to change without notice.

Free Manuals Download Website

<http://myh66.com>

<http://usermanuals.us>

<http://www.somanuals.com>

<http://www.4manuals.cc>

<http://www.manual-lib.com>

<http://www.404manual.com>

<http://www.luxmanual.com>

<http://aubethermostatmanual.com>

Golf course search by state

<http://golfingnear.com>

Email search by domain

<http://emailbydomain.com>

Auto manuals search

<http://auto.somanuals.com>

TV manuals search

<http://tv.somanuals.com>