Vivitar®

Vivicam 3705 User Manual



English

040408TP

FCC STATEMENT

This device complies with Part 15 of the FCC Rules. Operation is subject to the following two conditions:

- (1) This device may not cause harmful interference, and
- (2) This device must accept any interference received, including interference that may cause undesired operation

Note: This equipment has been tested and found to comply with the limits for Class B digital devices, pursuant to Part 15 of the FCC rules. These limits are designed to provide reasonable protection against harmful interference in a residential installation. This equipment generates, uses and can radiate radio frequency energy and, if not installed and used in accordance with the instructions, may cause harmful interference to radio communications. However, there is no guarantee that interference will not occur in a particular installation. If this equipment does cause harmful interference to radio or television reception, which can be determined by turning the equipment off and on, the user is encouraged to try to correct the interference by one or more of the following measures:

- Reorient or relocate the receiving antenna
- Increase the separation between the equipment and receiver
- Connect the equipment into an outlet on a circuit different from that to which the receiver is connected
- Consult the dealer or an experienced radio/TV technician for help

Use of shielded cable is required to comply with Class B limits in Subpart B of Part 15 of the FCC rules. Do not make any changes or modifications to the equipment unless otherwise specified in the manual. If such changes or modifications should be made, you could be required to stop operation of the equipment.

TRADEMARK INFORMATION

- Microsoft® and Windows® are U.S. registered trademarks of Microsoft Corporation.
- Pentium® is a registered trademark of Intel Corporation.
- Macintosh is a trademark of Apple Computer, Inc.
- SD™ is a trademark.
- Adobe, the Adobe logo, and Acrobat are trademarks of Adobe Systems Incorporated.
- Other names and products may be trademarks or registered trademarks of their respective owners.

READ THIS FIRST

Notice:

1. Product design and specifications are subject to change without notice. This includes primary product specifications, software, software drivers, and user's manual. This User Manual is a general reference guide for the product.
2. The product and accessories that come with your camera may be different from those described in this manual. This is due to the fact that different retailers often specify slightly different product inclusions and accessories to suit their market requirements, customer demographics, and geographical preferences. Products vary often between retailers especially with accessories such as batteries, chargers, AC adapters, memory cards, cables, carrying cases/pouches, and language support. Occasionally a retailer will specify a unique product color, appearance, and internal memory capacity. Contact your dealer for precise product definition and included accessories.
3. The manufacturer assumes no liability for any errors or discrepancies in this user's manual.
4. For driver updates, revisions to this manual, and manuals in other languages please refer to our website.

WARNINGS

- Do not use this camera if it is emitting smoke (or an unusual odor), if it becomes unusually hot to the touch, produces a peculiar noise, or exhibits any other abnormal conditions. Operating the camera in any of these circumstances may cause a fire or an electrical shock. Stop using the camera immediately, turn the camera off, remove the batteries, and disconnect the power source if you are using an AC power adapter. Contact your dealer or authorized service facility for repairs. Never attempt to repair this camera by yourself, as this may be dangerous.
- Do not expose the camera to moisture and make sure no water gets into the camera. Take particular care when using the camera under extreme weather conditions, such as rain or snow, or when operating the camera at the beach or near water. Avoid using this camera in places subject to extreme moisture. Do not use the camera if water has entered the camera. Turn the camera off, remove the batteries, and disconnect the power source if you are using an AC power adapter. Unplug the adapter from the AC power outlet after you have disconnected the camera. Contact your dealer or authorized service facility. Do not continue to use the camera as this may cause a fire or an electrical shock.
- Do not touch the power plug during a thunderstorm if you are using the AC power adapter. This may cause an electrical shock.
- Do not use the camera if any foreign objects have entered the camera. Turn the camera off, remove the batteries, and disconnect the power source if you are using an AC power adapter. Unplug the adapter from the AC power outlet after you have disconnected the camera. Contact your dealer or authorized service facility. Do not continue to use the camera as this may cause a fire or an electrical shock.
- Do not place the camera in an unstable location such as on a wobbly table or sloping surface where the camera may fall or tip over and cause injury. If the camera has been dropped or damaged, turn the camera off and remove the batteries or AC power adapter. Contact your dealer or authorized service facility. Do not continue to use the camera as this may cause a fire or an electrical shock.
- Do not insert or drop metallic or other foreign objects into the camera through access points such as the SD memory card slot. This may cause a fire or an electrical shock.
- Do not attempt to modify this camera. Do not remove the camera casing. This may cause a fire or an electrical shock. Internal inspection and repairs should only be carried out by an authorized service facility.
- Never operate this camera in any way while driving a vehicle. This may cause a traffic accident.

CAUTIONS

- Do not place this camera in a location affected by oil fumes or steam, such as near a cooking stove or humidifier. This may cause a fire or an electrical shock.
- Do not leave this camera in a location subject to extremely high temperatures, such as in a sealed vehicle or in direct sunlight. Exposure to high temperatures may adversely affect the camera case and internal components and may cause a fire.
- Do not cover or wrap the camera or AC power adapter with a cloth or quilt. This may cause heat to build up and distort the camera case and cause a fire. Always use the camera and accessories in well-ventilated locations.
- Handle the camera carefully and do not expose the camera to shock or vibration. Handling the camera roughly may cause a malfunction.
- When handling and moving the camera, always unplug it from the power source (if you are using an AC power adapter). Unplug the adapter from the AC power outlet after you have disconnected the camera. Failure to do so may result in an electrical shock.
- Do not use batteries other than those specified for use with your camera. Use of unsuitable batteries may result in the batteries splitting, or leaking and may cause a fire, injury, or soiling of the battery compartment.
- When placing the batteries into the camera, check the polarity markings on the batteries (- and +) to ensure that the batteries are inserted correctly. Incorrect battery polarity will result in camera inoperability and may result in the batteries splitting or leaking and causing a fire, injury, or soiling of the battery compartment.
- Remove the batteries if the camera will not be used for an extended period of time. The batteries may leak and cause a fire, injury or soiling of the battery compartment. If the batteries leak, clean and wipe the battery compartment carefully and install new batteries. Wash your hands carefully if you touch the battery fluid.

CONTENTS

INTRODUCTION.....	8
Overview.	
Package Contents	
GETTING TO KNOW YOUR CAMERA.....	9
Front View	
Rear View	
LED Indicators	
LCD Display Icons	
GETTING STARTED.....	13
Installing Batteries	
Using an AC Power Adapter (optional accessory)	
Inserting an SD Memory Card (optional accessory)	
Attaching the Hand Strap	
Language Selection	
Setting the Date and Time	
Setting Image Resolution and Quality	
RECORD MODE.....	18
Taking Images	
Portrait Mode	
Landscape Mode	
Digital Zoom	
Self-timer	
Macro Mode	
Flash	
Taking Pictures Manually	

PLAYBACK MODE	24
Viewing Images	
Zoom Playback	
Displaying Thumbnail Images	
Slideshow Display	
Protecting Images	
Deleting Images	
MOVIE MODE	29
Recording Video Clips	
Viewing Video Clips	
TRANSFERRING RECORDED IMAGES AND VIDEOS TO YOUR COMPUTER	31
Step 1: Installing the USB Driver	
Step 2: Connecting the Camera to Your Computer	
Step 3: Downloading Image and Video Files	
INSTALLING PHOTOSUITE	34
INSTALLING PHOTOVISTA	35
INSTALLING AROBAT READER	36
USER'S MANUAL ON CD-ROM	37
MENU OPTIONS	38
Record Menu	
Movie Menu	
Playback Menu	
Setup Menu	
CONNECTING THE CAMERA TO OTHER DEVICES	49
CAMERA SPECIFICATIONS	50

INTRODUCTION



Overview

Your new digital camera delivers high quality, 2048 x 1536 resolution images using a 3.3 Mega pixel imager. Using either the optical viewfinder or the 1.5" TFT color image LCD display, you can compose images and then examine them in detail. An auto-flash sensor automatically detects the shooting (lighting) conditions and determines whether the flash should be used. This feature helps ensure that your images turn out right.

8MB internal (built-in) memory lets you capture and store images without the need for an additional memory card. However, you may wish to expand the memory capacity (up to 256MB capacity) by using an external memory card.

In addition to still images, you can record short videos using the movie function.

Images you have taken can be downloaded to your computer using the USB cable (USB driver required for Win 98 and Mac OS 8.6) You can enhance and retouch your images on your computer by using the provided editing software, or image editing software you may already own. You may share your images with your friends via e-mail, in a report, or on a website.



Package Contents

Carefully unpack your camera and ensure that you have the following items:

Common Product Components:

- Digital Camera
- USB cable
- Software CD-ROM
- User's Manual
- Camera strap
- 2 x AA alkaline batteries

Common (Optional) Accessories:

- SD memory card, up to 256MB capacity
- Camera pouch
- AC power adapter

Note: Accessories and components vary by retailer.

GETTING TO KNOW YOUR CAMERA

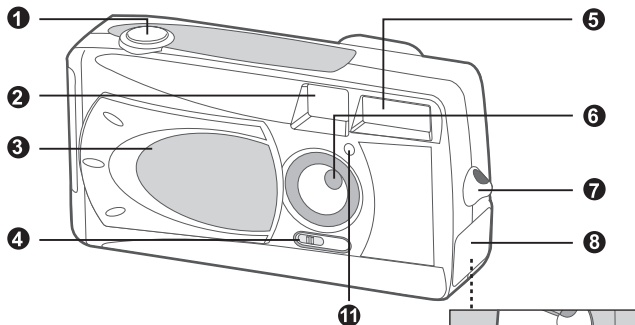

FRONT VIEW

1. Shutter button
2. Viewfinder window
3. Lens cover
4. Focus switch
5. Flash
 - 🌸 Macro mode
 - 👤 Portrait mode
 - ▲ Landscape mode
6. Lens
7. Hand strap eyelet
8. Jack cover
9. DC IN jack
10. USB connector
11. Self-timer LED

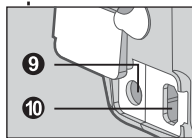

REAR VIEW

12. LED indicator
13. Viewfinder
14. LCD display
15. ICI Display button
16. Menu button
17. Power button
18. Tripod socket
19. **Mode** Mode button
20. Battery/SD memory card cover
21. Arrow button (left)
- Flash button
22. Arrow button (up)
- Thumbnail button
23. Arrow button (right)
- Self-timer button
24. Arrow button (down)
- Delete button
25. **OK** OK button
- Digital zoom button

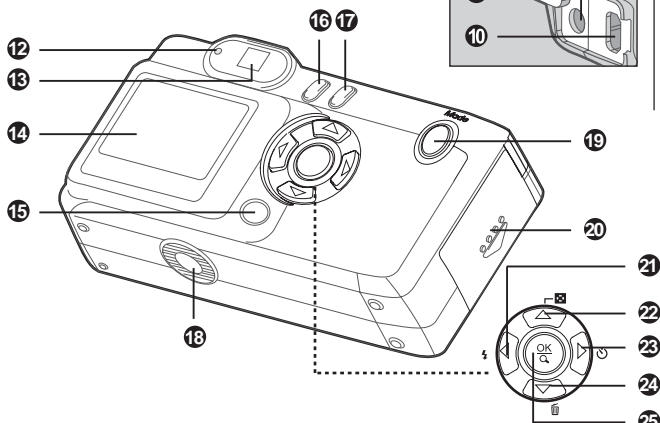



LED and Audible indicators

Indicator	Status	Description/Activity	Sound
LED indicator	Blinking red (after camera is powered on)	The camera is powering up (approx. two seconds)	No
LED indicator	Blinking red *(3)	Camera system error	Yes *(3)
LED indicator	Blinking green (after changing flash mode)	Charging the flash capacitor (flash icon on LCD display flashes red)	No
LED indicator	Blinking red (after picture has been taken or while a movie is being recorded)	An image is being recorded to memory card, or a movie is being recorded	No
LED indicator	Blinking red (while connecting to computer)	USB communication/transfer in progress	No
LED indicator	Solid green (in record or movie mode)	The camera is ready to record images (or movies)	Yes *(1)
Self-timer indicator	Blinking red	The self-timer function is activated	Yes *(1)
Three beeps	—	Error message	Yes *(3)
One beep	—	Valid button event	Yes *(1)

*(1) The camera sounds one beep

*(3) The camera sounds three beeps



LCD Display Icons

Display icons – Still Image Record Mode:

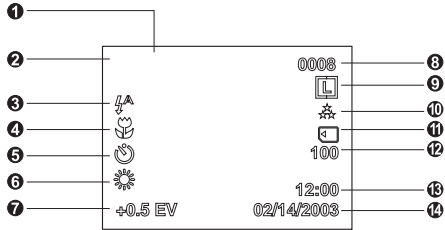

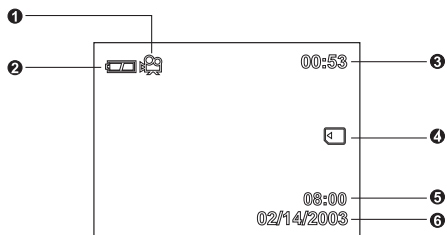

Display icons – Movie Mode:

1. Movie mode
2. Battery level
3. Recordable movie time available
4. Memory Card indicator
5. Time
6. Date

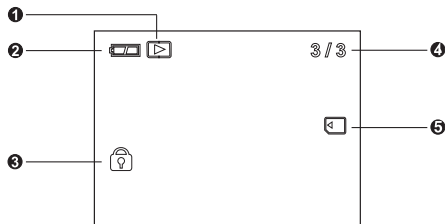

Display icons – Still-Image Playback Mode:

1. Playback mode
2. Battery level
3. Image Protected indicator (if protected)
4. Frame number
5. Memory Card indicator

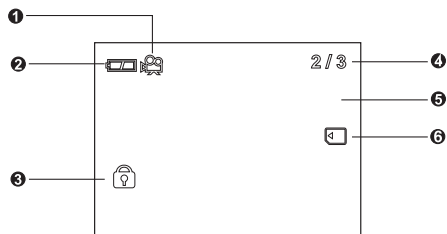

Display icons – Video (movie) Playback Mode:

1. Movie mode icon
2. Battery level
3. Movie Protected indicator (if protected)
4. Frame number
5. The first frame of the movie
6. Memory Card indicator

GETTING STARTED

You can use 2 AA size batteries (Alkaline, Ni-MH), or an AC power adapter (optional accessory) to power the camera. Battery power is convenient for capturing images or video clips while an AC adapter power is useful when transferring images to your computer.



Installing Batteries

1. Make sure the camera is turned off.
2. Slide the battery/SD memory card cover in the direction of the [OPEN] arrow.
3. Insert the batteries, noting correct polarity (+ and -).
4. Close the battery/SD memory card cover firmly.

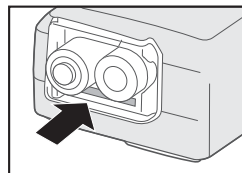

Note:

- If you will not be using the batteries for an extended period of time, remove them from the camera to prevent leakage or corrosion.
- Never use manganese batteries.
- Never use batteries of different type (together) or mix old and new batteries.
- Avoid using batteries in extremely cold environments as low temperatures can shorten the battery life and reduce camera performance.



Using an AC Power Adapter (optional accessory)

1. Make sure the camera is turned off.
2. Open the jack cover and connect one end of the AC power adapter to the jack labeled "DC IN".
3. Connect the other end to an electrical outlet.

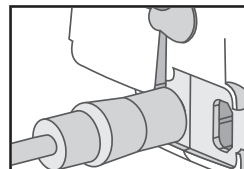

Note:

- Make sure to use only the AC power adapter specified for the camera. Damage caused by the use of an incorrect adapter is not covered under the warranty.
- Using an AC power adapter while transferring images to your computer prevents unexpected automatic power off of the camera.



Inserting an SD Memory Card (optional accessory)

The camera comes with 8MB of internal memory, allowing you to store images and video clips in the camera. However, you can expand the memory capacity by using an optional SD (Secure Digital) memory card so that you can store additional images and video clips.

1. Make sure the camera is turned off.
2. Slide the battery/SD memory card cover in the direction of the [OPEN] arrow.
3. Insert an SD memory card:
 - The front side of the memory card (printed arrow) should face towards the front side of the camera.
 - If the card cannot be inserted, check the orientation.
4. Close the battery/SD memory card cover.

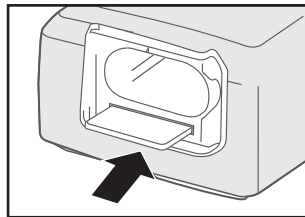

To remove a memory card:

Make sure the camera is turned off. Open the battery/SD memory card cover. Press lightly on the edge of the memory card and it will eject.

Note:

- To prevent valuable data from being accidentally erased from an SD memory card you can slide the write protect tab (on the side of the SD memory card) to "LOCK".
- To save, edit, or erase data on an SD memory card, you must unlock the card.

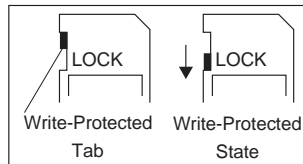





Setting the Date and Time

The Date Type and Date Setup screens will be presented if/when:

- Camera is turned on for the first time (after you select a language).
- Camera is turned on after leaving the camera without batteries for an extended period of time.

When the Date Type screen appears, follow these steps to select the date display format. Select the desired date type by pressing the **▲ / ▼** buttons, and press the **OK** button to confirm the selection.

When the Date Setup screen appears, follow these steps to set the correct date and time.

Note:

- You may skip this procedure by pressing the **OK** button repeatedly.

Select the year, month, day, and time fields by using the **◀ / ▶** buttons. Press the **OK** button after each field is set.

- To increase a value, press the **▲** button.
- To decrease a value, press the **▼** button.

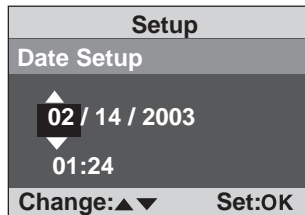
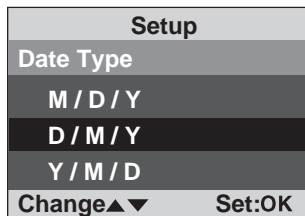

Setting Image Resolution and Quality

Resolution and quality settings determine the pixel size (dimension), image file size, and compression ratio for your images.

These settings affect the number of images that can be stored in memory, or on an SD memory card. As you get to know the camera, it is recommended that you try each quality and resolution setting to get an appreciation for the effects that these settings will have on your images.

- 16 Higher resolution and higher quality images offer the best photographic results but produce large file sizes. Therefore, fewer images will take up more memory space.



High resolution and quality settings are recommended for printed output and situations requiring the finest detail. Lower resolution/quality images take up less memory space and may be quite suitable for sharing images via e-mail, in a report, or on a web page.

To change image resolution or image quality, perform these steps below:

1. Power on the camera. (If already on, toggle the **Mode** button to the  mode.













2. Press the menu  button.
The Record menu appears.

3. Select **Image Size** or **Quality** by using the  /  buttons.

4. Press the  button. Select the image size or image quality you prefer by using the  /  buttons.

5. Press the **OK** button to confirm.
To exit the menu screen, press the menu  button.

This table shows the approximate number of images that you can store at each setting in 8MB internal memory or using an optional 8MB or 16MB SD memory card:

Resolution	Quality	Compression ratio	8 MB internal memory	8MB SD memory card	16MB SD memory card
 2048x1536 pixels	 Super fine	4:1	6	3	10
	 Fine	8:1	9	6	15
	 Normal	12:1	18	12	30
 1024x768pixels	 Super fine	4:1	12	10	20
	 Fine	8:1	18	15	30
	 Normal	12:1	37	30	65
 640x480 pixels	 Super fine	4:1	25	18	38
	 Fine	8:1	37	30	62
	 Normal	12:1	76	62	120

* The above data shows the standard testing results. The actual capacity varies according to the shooting conditions and settings.
Download from www.Somanuals.com. All Manuals Search And Download.

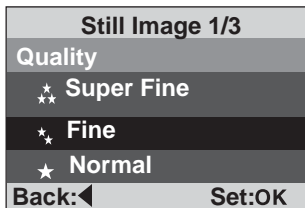
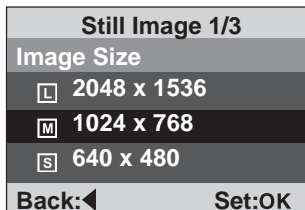



RECORD MODE



Taking Images



Your camera is equipped with both an optical viewfinder and a 2.1" LCD display to compose images. Taking images using the optical viewfinder will conserve battery power. If your batteries are low, it is recommended that you only compose images by using the viewfinder. Using the LCD display, you can compose images more accurately, but at the cost of battery consumption. Always use the image LCD for macro shots, however, to avoid parallax effects. The LCD image display must be used when Digital Zoom is used.

Using the Viewfinder

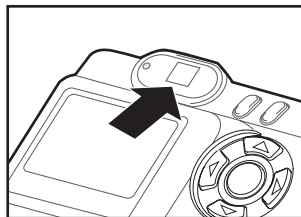
1. Open the lens cover.
2. Turn the camera on by pressing the power  button. (The camera will always power-up in still-image record mode.)
3. If not in record mode, toggle the **Mode** button to the  mode.
 - If you turn on the camera with the lens cover closed, a message "Lens Cover Closed" will appear on the LCD display.
4. Compose your shot in the viewfinder.
5. Press the shutter button.
 - The LED indicator blinks red while the camera is processing the image.



Using the LCD Display

1. Open the lens cover.
2. Turn the camera on by pressing the power  button. (The camera will always power-up in still-image record mode.)
3. If not in record mode, toggle the **Mode** button to the  mode.
 - If you turn on the camera with the lens cover closed, a message "Lens Cover Closed" will appear on the LCD display.

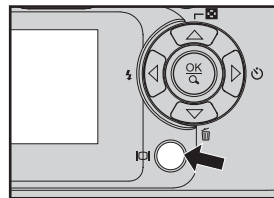

4. Turn on the LCD display and icons by pressing the LCD button.
5. Compose your shot on the display screen.
6. Press the shutter button.
 - The LED indicator blinks red while the camera is processing the image.

Note:



- By pressing the LCD button repeatedly in the  mode, the image display changes as follows:

Image and all OSD (on-screen display) icons -> Image only -> LCD display off

- The LCD display darkens in strong sunlight or bright light. This is not a malfunction.
- Using the LCD display for an extended period of time will consume battery power and decrease the number of images you can take. To increase battery longevity, turn the LCD display off and use the viewfinder instead.
- Always use the image LCD for macro shots.
- The LCD image display must be on when Digital Zoom is used.

Portrait Mode

Taking pictures by selecting the portrait mode will produce an image with a sharp subject and indistinct background. The effective range of focus is between 3 feet and 6 feet (0.9 meters and 1.9 meters.)

1. Open the lens cover, power on the camera. Make sure the camera is in Record  mode.
2. Move the focus switch located on the front side of the camera to the  position.
 - The  icon appears on the LCD display.
3. Compose your scene.
4. Press the shutter button.

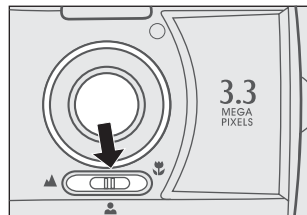

Landscape Mode



The landscape mode, suitable for scenery shooting, is used when the distance to the subject is greater than 6 feet (1.9 meters)

1. Open the lens cover, power on the camera. Make sure the

camera is in Record

Self-Timer

The self-timer duration is ten seconds. Activate the self-timer by pressing the shutter button. The self-timer LED blinks slowly for seven seconds and then blinks rapidly for the last three seconds. This allows you to get into the scene when taking group images.

1. Secure the camera to a tripod or place it on a stable surface.
2. Open the lens cover, power on the camera. Make sure the camera is in Record  mode.
 - The  icon appears on the LCD monitor.
3. Press the  button.
 - The self-timer function is activated.
4. Compose the scene.
5. Press the shutter button.
 - The self-timer mode is activated.
6. After ten seconds, the camera takes an image.
 - To cancel the self-timer at any time, press the shutter button to disrupt the sequence.

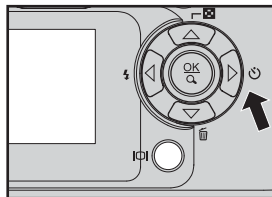

Note:

- After an image is taken using self-timer, the self-timer mode is turned off.
- If you wish to take another image using the self-timer, repeat these steps.



Macro Mode

Use the macro (close-up) mode to shoot a close-up of a subject (such as flowers or insects) where the range is between 21 and 36 inches (0.55 and 0.9 meters).

1. Open the lens cover, power on the camera. Make sure the camera is in Record  mode.
2. Move the focus switch located on the front side of the camera to the  position.
 - The  icon appears on the LCD display.
3. Compose the scene.

4. Press the shutter button.

- To disable macro photography, slide the focus switch back to portrait or landscape mode.

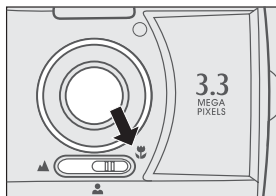

Note:

- When shooting a close-up in macro mode, use the image LCD display to compose your shot, avoiding the off-center parallax phenomenon.
- After a macro shot is taken DO NOT FORGET to reset the lens to the landscape or portrait positions.



Flash

The flash is designed to function automatically when lighting conditions warrant the use of flash. You can take an image using a flash mode suitable to your circumstances. If you change the flash mode, the camera will retain that setting even if the camera is turned off.



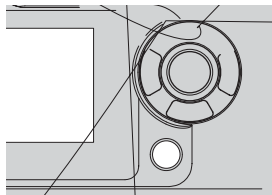

1. Open the lens cover, power on the camera. Make sure the camera is in Record  mode.
2. Press the  button repeatedly until the desired flash mode appears.
3. Compose the image and press the shutter button.

Note:

- When switching to a flash mode, it will take several seconds to charge the flash capacitor. While the flash capacitor is charging, the LED indicator will blink green and the flash icon will blink red on the LCD display.
- If you will not be using the flash, turn it off. Turning the flash OFF will result in faster camera startup and faster operation because the capacitor will not be charged needlessly. Turning the flash OFF when not needed will also improve battery life.











The camera has four flash modes: Automatic Flash (default), Red-Eye Reduction, Fill Flash (On), and Flash Off. The modes appear, cyclically, when you press the  button. The table below will help choose the appropriate flash mode:

Flash mode	Description
 Auto flash	The flash fires automatically according to the ambient lighting conditions. Select this mode for general flash photography.
 Red-eye reduction	The flash emits a precursor-flash before the main flash fires. This causes the pupil in the human eye to constrict, reducing the red-eye phenomenon. Select this mode when taking images of people and animals in low-light conditions.
 Fill flash	The flash will always fire regardless of the surrounding brightness. Select this mode for recording images with high contrast (backlighting) and deep shadows. Also known as forced flash.
 Flash off	The flash will not fire. Select this mode when taking images in a place where flash photography is prohibited, or when the distance to the subject is beyond the effective range of the flash.

Taking Images Manually

You can manually adjust conditions such as EV compensation, white balance or ISO speed when taking pictures. For EV compensation, white balance or ISO speed information, refer to Exposure, White Balance or ISO in the Record menu. To take images manually:

1. Open the lens cover, power on the camera. Make sure the camera is in Record  mode.
2. Press the menu  button.
3. Move to **Exposure**, **White Balance**, or **ISO** using the / buttons.
4. Press the  button to enter a sub-menu.
5. Change the setting using the  / buttons and then press the **OK** button to confirm your selection.
6. Press the menu  button to close the menus.
7. Compose your image.
8. Press the shutter button to capture an image with your new setting.

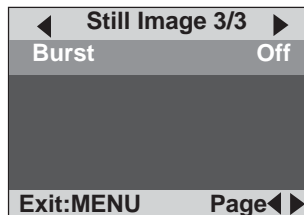
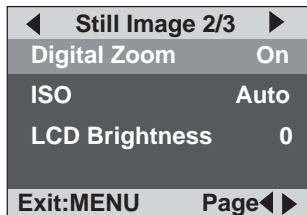
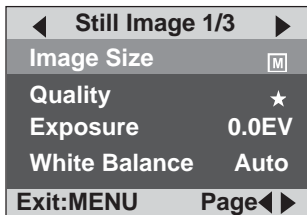







PLAYBACK MODE

In the playback  mode, you can view, magnify, delete images, play video clips, or run a slide show. Playback mode also provides a thumbnail image display, allowing you to quickly search for the image you want.

Viewing Images

You may view your images without opening the lens cover since the lens is not used for playback. The camera lens is protected during playback.





1. Power on the camera and toggle the **Mode** button to the playback  mode.
2. Viewing your images using the  /  buttons.
 - To view the previous image, press the  button.
 - To view the next image, press the  button.
 - Press the  button to display the detailed image information, such as image quality, image size and date.

Note:

- If there are no images stored in memory, "No images in memory" will appear on the LCD display.

Zoom Playback

While reviewing your images, you may enlarge a selected portion of an image. This magnification allows you to view fine details.

1. Power on the camera, and toggle the **Mode** button to the playback  mode.
2. Select the image that you want to view using the  /  buttons.
3. Enlarge the image by pressing the  button (the **OK** button).
 - Pressing the  button once magnifies the image to 2X.
 - Pressing it again magnifies the image to 4X.

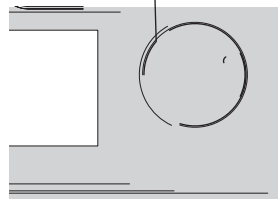
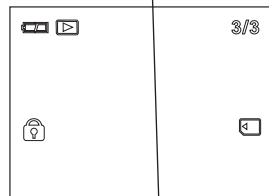

- To view the different portion of the enlarged image, press the ▲ / ▼ / ◀ / ▶ buttons.
- To return to the regular display (cancel playback zoom) from 4X-enlarged status, press the 🔍 button again.

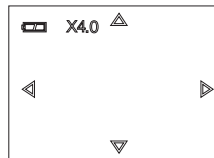

Displaying Thumbnail Images

This function allows you to view as many as nine thumbnail images on the LCD display simultaneously so you may search for a particular image.

- Power on the camera, and toggle the **Mode** button to the playback [▶] mode.
- Press the [🗪] button. (Same as the ▲ button.).
 - Nine thumbnail images appear on the LCD display (Assuming there are nine or more images in memory).
 - To view a full-size image, selecting it by using the ▲ / ▼ / ◀ / ▶ buttons, and then press the **OK** button and the selected image will be displayed in the full LCD frame.

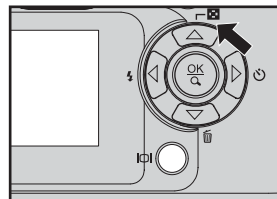

Slideshow Display

The slideshow function enables you to playback your images back automatically in sequential order as a slide show. This is a very useful and entertaining feature for reviewing recorded images and for presentations.

- Power on the camera, and toggle the **Mode** button to the playback [▶] mode.
- Press the menu [☰] button and move to **Slide Show** by using the ▲ / ▼ buttons.



3. Press the ► button.
4. Set the playback interval by using the ▲ / ▼ buttons and press the OK button.
 - The slideshow starts, displaying your images on the LCD display, one by one, at the set interval.
 - To stop the slideshow display, press the OK button.

Note:

- You can adjust the slideshow display interval from 0 to 30 seconds.
- If you set the interval to 0 seconds, the slideshow function is disabled.

Protecting Images

You can protect images and video clips from accidental erasure by using the Protect feature in the Playback menu. Follow these steps to protect an image or video.

Protecting an image or video clip:

1. Select the image/video clip you wish to protect by using the ◀ / ▶ buttons.
2. Press the menu [≡] button. Select **Protect** by using the ▲ / ▼ buttons.
3. Press the ► button.
4. Use the ▲ / ▼ buttons to select **This Image** and then press the ► button.
 - Note: To protect all images, select **All Images** in this step.
5. Select **Lock** by pressing the ▲ / ▼ buttons and press the OK button.
 - Once the image/video clip is protected, the 🔒 icon will display on the protected image/video clip.

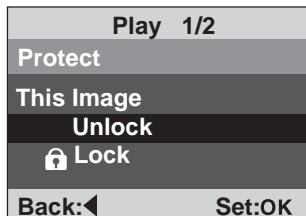
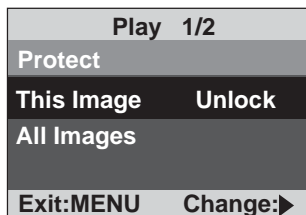

Removing protection from an image or video clip:

1. Perform steps 1 to 4 (see above).
2. Select **Unlock** by pressing the ▲ / ▼ buttons and press the **OK** button.

Note:

To erase protected image(s), use the format function. For more information about formatting, refer to **Format Media** in the Setup menu.

Deleting Images





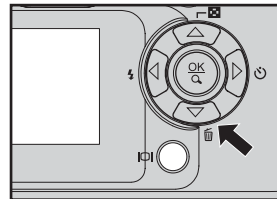

You can delete an image or video clip by pressing the delete  button. To delete all images and video clips at once, you can delete them by using the Delete All function in the Playback menu.

To delete one image or video clip:

1. Select the image/video clip you wish to delete by using the ◀/▶ buttons, and then press the  button. (Same as the ▼ button)
2. When the message appears, select [Yes] by using the ▲ / ▼ buttons and then press the **OK** button.
 - The next image/video clip appears.
 - If you wish to cancel the deletion, select [No].
3. Continue deletions, as desired. If all images are deleted, "No images in memory" will be displayed.



To delete all (unprotected) images or video clips (at once):

1. Press the menu  button.
2. Select **Delete All** by using the  /  buttons.
3. Press the  button.
4. Select [Yes] by using the  /  buttons and press the **OK** button to delete all images and return to playback menu screen.
5. To exit from the playback menu, press either the **Mode** or menu  buttons.
6. If you return to Playback mode, the message "No images in memory" appears because all images and video clips have been deleted.

Note:

- If you have protected any of your images or video clips, they will not be deleted using the **Delete All** function.
- To delete images or videos stored in internal memory, **do not** insert a memory card into the camera. Otherwise, you will delete the images or video clips stored on the memory card.

Play	1/2
Protect	Unlock
Delete All	
Slide Show	Off
LCD Brightness	0
Exit:MENU	Change:▶

Play	1/2
Delete All	
No	
Yes	
Back:◀	Set:OK

MOVIE MODE

Recording Video Clips

The movie mode allows you to record video clips at a resolution of 320 x 240 pixels.

1. Power on the camera, and toggle the **Mode** button to the  mode.
 - The amount of time available for movie recording is displayed on the LCD display. (The time format is Minutes: Seconds)
 - If you turn on the camera with the lens cover closed, a message "Lens Cover Closed" will appear on the LCD display.
2. To start recording a video clip press (and release) the shutter button.

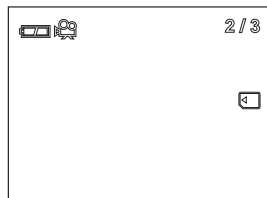



- The elapsed time is displayed on the LCD display while recording. The red LED will flash while recording.
- To stop recording, press the shutter button again.

Notes about Movie Mode:

- Resolution is always 320x240 and image quality cannot be specified.
- The self-timer cannot be adjusted used.
- You can use digital zoom for movies. However, you must set the digital zoom-factor before you start recording. Zoom cannot be adjusted or changed while recording a video clip.
- The flash mode is automatically set to [OFF].

Viewing Video Clips

To view a recorded video clip, follow these steps:

1. Power on the camera, and toggle the **Mode** button to the playback  mode.
2. Select the video clip you wish to view using the  /  buttons.
3. Press the **OK** button to start.

- To pause playback at any time, press the **OK** button.
 - Press the **OK** button again to resume playback.
 - Press and hold the ► button to forward the movie clip. (Release to stop)
 - Press and hold the ◀ button to backup the movie clip. (Release to stop)
- To exit this movie playback and return to the playback mode, press the ▼ button.

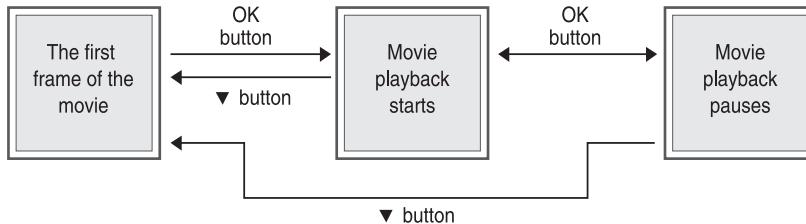

Notes about Video Playback:

- The zoom function cannot be activated during movie playback.
- To play the video clip back on your computer, you may use either Windows Media Player or Apple "QuickTime Player".
- QuickTime basic player is available free of charge, compatible with both Mac- and Windows- computers and can be download from the Apple web site at www.apple.com. For help using QuickTime Player usage, please refer to the QuickTime on-line help for more information.
- Video clips are in the AVI file format, 320 x 240 at 15fps

TRANSFERRING RECORDED IMAGES AND VIDEOS TO YOUR COMPUTER

To transfer images/video clips from the camera to your computer, follow these steps:

Step 1: Installing the USB driver (Windows 98 and Mac OS 8.6 users only)

Step 2: Connecting the camera to your computer

Step 3: Downloading image and video files

System Requirements (Windows)

- Pentium 200 MHz or higher
- Windows 98/98SE/Me/2000/XP
- 64MB RAM
- 128MB hard disk space
- CD-ROM drive
- An available USB port

System Requirements (Macintosh)

- PowerPC G3/G4
- OS 8.6 or later
- 64MB RAM
- 128MB hard disk space
- CD-ROM drive
- An available USB port



Step 1: Installing the USB Driver

Windows 98 computers

The USB driver on the CD-ROM is exclusively for Windows 98 computers. Installing the USB driver on computers running Windows 2000/ME/XP is not necessary.

1. Insert the CD-ROM that came with the camera into your CD-ROM drive. The welcome screen appears.
2. Click "Install USB driver". Follow the on-screen instructions to complete the installation. After the USB driver has been installed, restart your computer.

Macintosh OS 8.6 computers

Mac OS 8.6 users must install a USB driver. For Mac OS 9.0 or higher, the computer will automatically recognize the camera and load its own USB drivers.

1. Insert the CD-ROM that came with the camera into the CD-ROM drive.
2. Select and double-click "Digital Camera Driver Installer."
3. Select "Install Location" and click "Install".
4. Follow the on-screen instructions to complete the installation and restart your computer.



Step 2: Connecting the Camera to Your Computer

1. Connect one end of the USB cable to an available USB port on your computer.
2. Connect the other end of the USB cable to the USB connector on the camera.
3. Turn the camera on.
4. From the Windows desktop, double click on "My Computer".
5. Look for a new "removable disk" icon. This "removable disk" is actually the memory (or memory card) in your camera. Typically, the camera will be assigned drive letter "e" or higher.

6. Double click on the removable disk and locate the DCIM folder.
7. Double click on the DCIM folder to open it to find more folders.
 - Your recorded images and video clips will be inside these folders
 - Copy & Paste or Drag-N-Drop image and video files to a folder on your computer.

Mac users: double-click the "unlabeled" disk drive icon on our desktop. iPhoto may automatically launch. The volume label may vary depending upon whether you use internal camera memory, or a memory card.

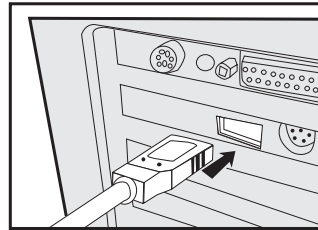



Step 3: Downloading Image and Video Files

When the camera is turned on and connected to your computer, it is considered to be a disk drive, just like a floppy disk or CD. You can download (transfer) images by copying them from the "removable disk" ("unlabeled" disk on a Macintosh) to your computer hard drive.

Windows -

Open the "removable disk" and subsequent folders by double clicking them. Your images are inside the folder(s). Select the images that you want, then choose "Copy" from the "Edit" menu. Open the destination location (folder) and choose "Paste" from the "Edit" menu. You may also drag and drop image files from the camera to a desired location.

Macintosh and Desktop/LX --

Open the "unlabeled" disk icon, and the destination location on your hard disk. Drag and drop from the camera to the desired destination.

Note:

- It is recommended that you use an AC power adapter for the camera while transferring images and video clips from the camera to your computer since camera power may be cut off unexpectedly if the batteries run out.
- Memory card users may prefer to use a memory card reader (highly recommended).

INSTALLING PHOTOSUITE

PC users will find that PhotoSuite is a very user-friendly image-editing program. With PhotoSuite, you can retouch, compose, and organize your images. It includes a variety of templates, such as photo frames, birthday cards, calendars and more. Get your images ready and explore this amazing program.

To install PhotoSuite:

1. Insert the CD-ROM that came with the camera into your CD-ROM drive. The welcome screen appears.
2. Click "Install PHOTOSUITE". Follow the on-screen instructions to complete the installation.

Note:

- To use PhotoSuite to edit and retouch your recorded images, please refer to the on-line help.
- For Windows 2000/XP users, please make sure to install and use the PhotoSuite in "Administrator" mode.
- PhotoSuite is not supported on the Mac. iPhoto or iPhoto 2 is recommended.

INSTALLING PHOTOVISTA

PC users will find that PhotoVista is an easy-to-use program that lets you create spectacular 360° panoramic images in a snap. When you view these panoramas, you get the experience of being totally immersed in a realistic environment. PhotoVista's powerful engine quickly and automatically stitches images together, and its intuitive interface will let even a novice get great results in minutes.

To install PhotoVista:

1. Insert the CD-ROM that came with the camera into your CD-ROM drive. The welcome screen appears.
2. Click "Install PHOTOVISTA". Follow the on-screen instructions to complete the installation.

Note:

- To use PhotoVista to create spectacular 360° panoramic images, please refer to the on-line help for this software.
- For Windows 2000/XP users, please make sure to install and use the PhotoVista in "Administrator" mode.
- PhotoVista is not supported on the Mac.
- Windows XP users who have not installed XP Service Pack 1, be sure to link to <http://java.sun.com/getjava/download.html> first and download the Java Virtual Machine installation. For more information about Java, please refer to its on-line help at <http://java.sun.com/getjava/help.html>
After this Java installation, you can install iSee Media PhotoVista.
- PhotoVista System Requirements are:
 - Windows 98, Windows NT 4 (Service Pack 3 or higher)
 - Windows 2000, Windows Me, Windows XP Service Pack 1 or higher

INSTALLING ADOBE ACROBAT READER

The CD-ROM includes a PDF (portable document format) copy of the user's manual. To view a PDF you must have Acrobat Reader installed in your computer. Acrobat Reader is included on the camera CD ROM. Using Acrobat Reader, you can read the user's manual and print sections of interest.

1. Insert the CD-ROM that came with the camera into the CD-ROM drive. The welcome screen appears.
2. Click "Install ADOBE ACROBAT READER". Follow the on-screen instructions to complete the installation.

For Mac users:

1. Insert the CD-ROM that came with the camera into the CD-ROM drive.
2. Select and double-click "Acrobat Reader".
3. Select and double-click the language that you want.
4. Double-click "Reader Installer".
5. Follow the on-screen instructions to complete the installation.

USER'S MANUAL ON CD-ROM

A copy of the user's manual on is provided on the CD-ROM in PDF format. It is a backup copy of the printed manual. If you misplace the printed guide, you may print another copy from the CD-ROM. The only requirement for viewing the User Manual on the CD-ROM is that you have Acrobat Reader installed on your computer. Updates to this manual, and versions in other languages may be found on our website.

1. Insert the CD-ROM that came with the camera into the CD-ROM drive. The welcome screen appears.
2. Click "Install User's Manual". Follow the on-screen instructions to complete the installation.

Alternatively, browse the CD-ROM to find the PDF file.





For Mac users:

1. Insert the CD-ROM that came with the camera into the CD-ROM drive.
2. Select and double-click "Manual".
3. Select and double-click the language that you want.
4. Drag and drop the PDF file from the current location to the destination location. View the user's manual by opening it.

MENU OPTIONS



Record Menu

You can use the Record menu to select image size, image quality, or ISO speed. You can also adjust exposure, white balance or LCD brightness in the Record menu. The Record menu even allows you to enable digital zoom. To access the Record menu, toggle the **Mode** button to the  mode and press the menu  button. Scroll through the menu options by using the  /  buttons.

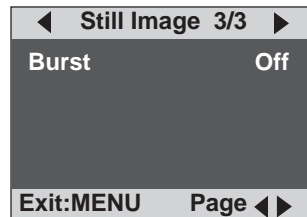
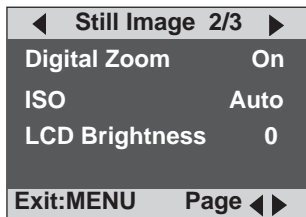
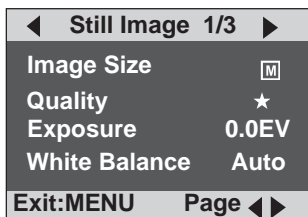

Image Size

Refer to section in this manual titled "Setting Image Resolution and Quality" for further details.

Quality

Refer to section in this manual titled "Setting Image Resolution and Quality" for further details.

Your camera adjusts the exposure of each scene automatically. However, if the subject is very dark, or very bright, you may override the camera's automatic exposure determination to make the subject brighter or darker. This is called EV compensation. The EV compensation can be adjusted from -1.8EV to +1.8EV. To select the EV compensation you wish, press the ► button. Then, use the ▲ / ▼ buttons to select the EV compensation you desire, and press the **OK** button.

Examples of Exposure Compensation -

Positive (+) Compensation

- Imaging printed text (black characters on white paper)
- Portraiture with back lighting
- Very bright scenes (such as snow) and highly reflective subjects
- Shots made up predominantly of sky

Negative (-) Compensation

- Spot lighted subjects, particularly against dark backgrounds
- Imaging of printed text (white characters on black paper)
- Scenes with low reflectivity, such as shots of green or dark foliage

White Balance

Your camera adjusts the white balance of each scene automatically. However, the images that your camera captures will appear different under different lighting conditions (sun, shade, fluorescent, tungsten lights). Unlike your eyes, which can easily adjust to different lighting conditions (lighting temperatures), a digital camera cannot always differentiate between lighting types. Under some lighting conditions the image may appear in strange shades. If that occurs, you may change the white balance setting by specifying a lighting condition (temperature) most appropriate for your scene. To set the white balance, press the ► button. Then

select the appropriate white balance by using the ▲ / ▼ buttons, and press the **OK** button.

[Auto]: Camera automatically adjusts white balance

[ Daylight]: For outdoors on a bright day

[ Cloudy]: For cloudy and shady sky

[ Sunset]: For sunset condition

[ Tungsten]: For tungsten lighting

[ Fluorescent]: For fluorescent lighting

Digital Zoom

You can take shots with the digital zoom by activating the digital zoom function. To enable this option, press the ► button. Then select [On] by using the ▲ / ▼ buttons and press the **OK** button.

ISO

The ISO speed defines light sensitivity. The higher the ISO number is, the more sensitive it is to light. When recording under dark situations or recording a fast-moving subject, use a high-number setting. When recording high-quality images, use a low-number setting. To set the ISO speed, press the ► button. Then select the ISO speed you prefer by using the ▲ / ▼ buttons and press the **OK** button.

[Auto]: Camera automatically adjusts ISO speed

[100]: Equivalent to ISO 100

[200]: Equivalent to ISO 200

[400]: Equivalent to ISO 400

LCD Brightness

This option adjusts the brightness of the LCD display. To adjust the LCD brightness, press the ► button. Then increase or decrease the LCD brightness by using the ▲ / ▼ buttons and press the **OK** button.

Burst

This function allows you to capture a sequence of continuous images (frames). If burst function is enabled, the image resolution will be set to **M**1024x768 pixels. (To enable this function, press the ► button. Then select [On] by using the ▲ / ▼ buttons and press the **OK** button.)



The approximate number of images you can capture varies according to the quality (compression) settings:

★ ★	Super fine	approx. 2
★	Fine	approx. 4
★	Normal	approx. 7

Of course, the remaining memory capacity will also affect the number of shots that can be captured. The average burst interval is approximately 0.7 seconds. (1.4 fps)



Movie Menu





To adjust movie settings, press the menu  button in the  mode and navigate to the option you wish to set by using the ▲ / ▼ buttons. For more information about Exposure, White balance, ISO, LCD brightness and Digital zoom, refer in the Record menu section.

◀ Movie Clip 1/2 ▶	
Exposure	0.0EV
White Balance	Auto
ISO	Auto
LCD Brightness	0
Exit:MENU	Page ◀▶

◀ Movie Clip 2/2 ▶	
Digital Zoom	On
Exit:MENU	Page ◀▶



Playback Menu

Use the playback menu to create an on-camera slide show or transfer images from internal memory to a memory card. You can also use the Playback menu to protect an image, delete all images or adjust the LCD brightness. To access the playback menu, press the menu  button in the playback  mode and navigate through the options by using the  /  buttons.

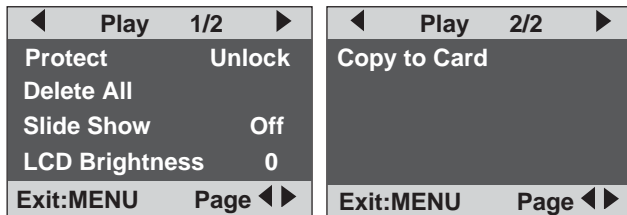

Protect

Refer to section in this manual titled "Protecting Images" in the PLAYBACK MODE for further details.

Delete All

Refer to section in this manual titled "Delete Images" in the PLAYBACK MODE for further details.

Slide Show

Refer to section in this manual titled "Slideshow Display" in the PLAYBACK MODE for further details.

LCD Brightness

Refer to LCD Brightness in the Record menu.

Copy to Card

This feature allows you to copy your images from the camera's internal memory to an SD memory card. Of course, you can only do this if you have an SD memory card installed and some images in internal memory.

To perform this function, press the ► button. Then, use the ▲ / ▼ buttons to select [Yes] and then press the OK button.



Setup Menu

Select your general camera preferences in the Setup mode. Toggle the **Mode** button until the Setup menu appears on the LCD display. Navigate to the option you wish to configure by using the ▲ / ▼ buttons.

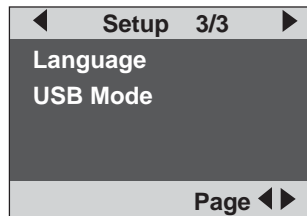
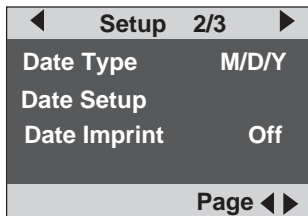
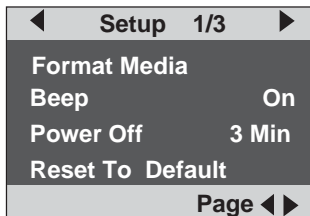

Format Media

This utility formats the internal memory (or memory card) and erases all stored images and data - even if they have been protected. To perform the format function, press the ▶ button. Select [Yes] by using the ▲ / ▼ buttons and press the **OK** button. Formatting is an irreversible action and data cannot be recovered at a later time.

Beep

The camera produces a sound (beep) each time you press a camera button, if this function is enabled. Press the ► button, then select [On] or [Off] by using the ▲ / ▼ buttons and then press the **OK** button.

Power Off

If there is no camera activity (no buttons are pressed) for a defined period of time while the camera is powered on, the camera will switch to an idle mode, and eventually turn itself off to conserve power.

Period of Inactivity (batteries)	Period of Inactivity (AC power adapter)	Camera status
60 seconds	60 seconds	Idle mode
30 minutes	30 minutes	Turn off

If the camera is idle, re-activate the camera by pressing any button on the camera. If the camera has powered-off you must to turn the camera on again by pressing the Ⓛ button.

The table (above) shows the default time settings for idle, and power-off.

You can change the power saving interval by pressing the ► button. Then, use the ▲ / ▼ buttons to select the desired interval time (from 1 to 30 minutes), and press the **OK** button.

Reset To Default

If you wish to restore all camera settings to their original status, select this option and press the ► button. Select [Yes] using the ▲ / ▼ buttons and then press the **OK** button.

The following table shows the default setting for each item:

Item	Description
Image Resolution	<input type="checkbox"/> 2048 X 1536 pixels
Image Quality	* Fine
Flash	Auto
LCD Brightness	0
White Balance	Auto
EV Compensation	0.0
Digital Zoom	On
Beep	On

Date Type

You can select the date type that is imprinted on your image. To set the date type, press the ► button. Then select one date type you prefer by using the ▲ / ▼ buttons and press the **OK** button.

[M/D/Y]

[D/M/Y]

[Y/M/D]

Date Setup

After removing the batteries from the camera, the date and time may return to the default settings. If this happens, reset the date and time when using the camera. Refer to section in this manual titled "Setting the Date and Time" for further details.

Date Imprint

If you set imprint function, your image will be displayed with the date on it. To enable this function, press the ► button. Then select [On] by using the ▲ / ▼ buttons and press the **OK** button.

Language

This option allows you to select the language for the menus and the text displayed on the LCD display. Refer to section in this manual titled "Language Selection" for further details.

USB Mode

While connecting camera to your computer via USB cable, your recorded images and video clips can be downloaded to your computer's hard drive. Refer to section in this manual titled "Transferring Recorded Images and Videos to Your Computer" for further details.

CONNECTING THE CAMERA TO OTHER DEVICES

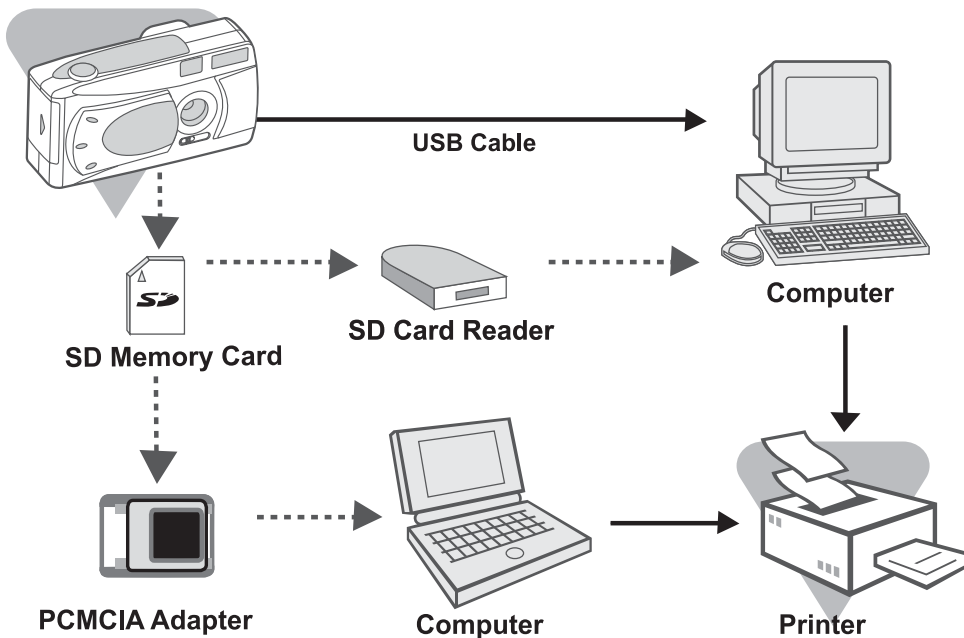

CAMERA SPECIFICATIONS

Item	Description
Sensor	Approx. 3.3 Mega pixel 1/2.7" CCD
Image resolution	2048 x 1536 pixels, 1024 x 768 pixels, 640 x 480 pixels
LCD	1.5" color TFT LCD
Self-timer	10 second delay
Zoom	4X digital zoom
Capture modes	Still Image, Video (movie) recording
Memory type	8 MB internal memory (common) SD memory card (optional, up to 256MB capacity)
Shutter speed	5 ~ 1/2000 sec.
Lens	Fixed focal length: 7.9 mm F-number: 3.5
Range of Focus	Landscape: Greater than 6 feet (1.9 meters to infinity) Portrait: 3 to 6 feet (0.9 to 1.9 meters) Macro: 21 to 36 inches (0.55 to 0.9 meters)
Exposure and Compensation	Automatic exposure with manual EV compensation +/- 1.8EV in 0.3EV steps
White balance	Automatic with presets for Daylight, Cloudy, Sunset, Fluorescent, Tungsten
Files formats	JPG, AVI (Motion JPEG) for video clip
File standards	JPEG, EXIF 2.1, DCF 1.1, M-JPEG
Interface (Ports)	DC IN jack, USB connector
Operating environment	Operation: 0°C to 40°C, 15% to 90% humidity Storage: -20°C to 60°C, 10% to 95% humidity
Power	2 AA Alkaline (1.5V) or Ni-MH (1.5V) batteries; or optional AC power adapter (2.5A/3.3V)
Dimensions	105 x 55 x 41 mm (W x H x D) (exclusive of protruding features)
Weight	Approx. 4.2 ounces (120g) (without batteries and memory card)

Free Manuals Download Website

<http://myh66.com>

<http://usermanuals.us>

<http://www.somanuals.com>

<http://www.4manuals.cc>

<http://www.manual-lib.com>

<http://www.404manual.com>

<http://www.luxmanual.com>

<http://aubethermostatmanual.com>

Golf course search by state

<http://golfingnear.com>

Email search by domain

<http://emailbydomain.com>

Auto manuals search

<http://auto.somanuals.com>

TV manuals search

<http://tv.somanuals.com>