Vivitar®

Vivicam 3715 User Manual



English

030401

FCC STATEMENT

This device complies with Part 15 of the FCC Rules. Operation is subject to the following two conditions:

- (1) this device may not cause harmful interference, and
- (2) this device must accept any interference received, including interference that may cause undesired operation

Note: This equipment has been tested and found to comply with the limits for Class B digital devices, pursuant to Part 15 of the FCC rules. These limits are designed to provide reasonable protection against harmful interference in a residential installation. This equipment generates, uses and can radiate radio frequency energy and, if not installed and used in accordance with the instructions, may cause harmful interference to radio communications. However, there is no guarantee that interference will not occur in a particular installation. If this equipment does cause harmful interference to radio or television reception, which can be determined by turning the equipment off and on, the user is encouraged to try to correct the interference by one or more of the following measures:

- Reorient or relocate the receiving antenna.
- Increase the separation between the equipment and receiver.
- Connect the equipment into an outlet on a circuit different from that to which the receiver is connected.
- Consult the dealer or an experienced radio/TV technician for help.

Use of shielded cable is required to comply with Class B limits in Subpart B of Part 15 of the FCC rules.

Do not make any changes or modifications to the equipment unless otherwise specified in the manual. If such changes or modifications should be made, you could be required to stop operation of the equipment.

この装置は、情報処理装置等電波障害自主規制協議会（VCCI）の基準に基づくクラスB情報技術装置です。この装置は、家庭環境で使用することを目的としていますが、この装置がラジオやテレビジョン受信機に近接して使用されると、受信障害を引き起こすことがあります。
取扱説明書に従って正しい取り扱いをして下さい。

TRADEMARK INFORMATION

- Microsoft® and Windows® are U.S. registered trademarks of Microsoft Corporation.
- Pentium® is a registered trademark of Intel Corporation.
- Macintosh is a trademark of Apple Computer, Inc.
- SD™ is a trademark.
- PhotoSuite, PhotoVista and the MGI logo are trademarks or registered trademarks of MGI Software Corp.
- Adobe, the Adobe logo, and Acrobat are trademarks of Adobe Systems Incorporated.
- Other names and products may be trademarks or registered trademarks of their respective owners.

E

READ THIS FIRST

Please start by reading the important messages below first.

1. The bundled driver, software, design, specifications and user's manual that were packaged with the camera are subject to change without notice.
2. The accessories that come with the camera may vary between regions.
3. For driver updates, you can contact the dealer where you purchased the camera for help.
4. We are not liable whatsoever for any compensation arising from errors in descriptions in this user's manual.

WARNINGS

- Do not use the camera if it is emitting smoke, becomes unusually hot to be touched, emitting any unusual odor or noise, or if it is in any other abnormal state. Operating the camera in any of these situations may cause a fire or an electrical shock. Stop using the camera immediately, turn the camera off, and then disconnect the power source (batteries or AC power adapter). (If you are using the AC power adapter, unplug the adapter from the AC power outlet after you have disconnected the camera.) After checking that smoke is no longer being emitted, contact your dealer or a local authorized service facility and request repairs. Never attempt to repair the camera yourself as this is dangerous.
- Do not use the camera if any foreign objects have entered the camera. Turn the camera off, and then disconnect the power source (batteries or AC power adapter). (If you are using the AC power adapter, unplug the adapter from the AC power outlet after you have disconnected the camera.) Then contact your dealer or a local authorized service facility. Do not continue to use the camera as this may cause a fire or an electrical shock.
- If the camera has been dropped or if the camera case has been damaged, turn the camera off, and then disconnect the power source (batteries or AC power adapter). (If you are using the AC power adapter, unplug the adapter from the AC power outlet after you have disconnected the camera.) Then contact your dealer or a local authorized service facility. Do not continue to use the camera as this may cause a fire or an electrical shock.
- Do not place the camera in any unstable locations such as on a wobbly table or sloping surface where the camera may fall or tip over and cause injury.
- Do not expose the camera to moisture and make sure that there is no water getting into the camera. Take particular care when using the camera under extreme weather conditions such as rain or snow, or when operating the camera at the beach or near water. Water in the camera may cause a fire or an electrical shock.
- Do not attempt to modify the camera. This may cause a fire or an electrical shock.
- Do not remove the camera casing. This may cause an electrical shock. Internal inspection, maintenance and repairs should only be carried out by your dealer or a local authorized service facility.
- Do not touch the power plug during a thunderstorm if you are using the AC power adapter. This may cause an electrical shock.

CAUTIONS

- Do not place the camera in damp or dusty locations. This may cause a fire or an electrical shock.
- Do not place the camera in a location affected by oil fumes or steam, such as near a cooking stove or humidifier. This may cause a fire or an electrical shock.
- Exposure to high temperatures may adversely affect the camera case and internal components and may cause a fire.
- Do not cover or wrap the camera or the AC power adapter with a cloth or quilt. This may cause heat to build up and distort the case and cause a fire. Always use the camera and its accessories in well-ventilated locations.
- Handle the camera carefully and do not bump the camera into any hard object. Handling the camera roughly may cause a malfunction.
- Do not move the camera while it is switched on. (If you are using the AC power adapter, unplug the adapter from the AC power outlet after you have switched off the camera.) Ensure that any connector cords or cables to other devices are disconnected before moving the camera. Failure to do so may damage the cords or cables and cause a fire or an electrical shock.
- When leaving the camera unused for long periods, such as during a vacation, always unplug the camera from the power source (batteries or AC power adapter) for safety. (If you are using the AC power adapter, unplug the adapter from the AC power outlet after you have disconnected the camera.) Failure to do so could result in a fire.
- Do not use batteries other than those specified for use with the camera. The use of unsuitable batteries may result in the batteries splitting or leaking and causing a fire, injury, or soiling of the battery compartment.
- When fitting batteries into the camera, check the polarity markings on the battery (- and +) to ensure that you insert the battery correctly. Incorrect battery polarity may result in the batteries splitting or leaking and causing a fire, injury, or soiling of the battery compartment.
- Remove the batteries if the camera will not be used for an extended period of time. The batteries may leak and cause a fire, injury or soiling of the battery compartment. If the batteries leak, clean and wipe the battery compartment carefully and install new batteries. Wash your hands carefully if you touch the battery fluid.

CONTENTS

INTRODUCTION	7	Using the macro mode	21
Overview	7	Using the flash	21
Package contents	7	Taking pictures manually	23
Optional accessories	7	PLAYBACK MODE	24
GETTING TO KNOW		Viewing images	24
THE CAMERA	8	Zoom playback	25
Front view	8	Displaying thumbnail images ..	26
Rear view	9	Slide show display	26
Mode dial	10	Protecting one image/ video clip	27
LED indicators	10	Protecting one image/video clip ...	27
LCD monitor information	11	Removing protection from one image/ video clip	27
GETTING STARTED	13	Deleting images/video clips	28
Installing the batteries	13	To delete one image/ video clip at a time:	28
Using the AC power adapter (optional accessory)	13	To delete all images/ video clips at once:	28
Loading an SD memory card (optional accessory)	14	MOVIE MODE	29
Attaching the strap	14	Recording video clips	29
Choosing the language	15	Viewing video clips	30
Setting the date and time	15	TRANSFERRING RECORDED IMAGES TO YOUR COMPUTER	31
Setting the image resolution and quality	16	Step 1: Installing the USB driver on Windows computers	32
RECORD MODE	17	Installing the USB driver on Macintosh computers	32
Taking pictures	17	Step 2: Connecting the camera to your computer	32
Using the viewfinder	17		
Using the LCD monitor	18		
Using the portrait mode	18		
Using the landscape mode	19		
Using the digital zoom	19		
Using the self-timer	20		

Step 3: Downloading images/ video clips	33
For computers running Windows ..	33
For computers running Mac OS	33

INSTALLING

MGI PHOTOSUITE	34
-----------------------------	-----------

INSTALLING

MGI PHOTOVISTA	35
-----------------------------	-----------

INSTALLING

ACROBAT READER	36
-----------------------------	-----------

USING THE USER'S

MANUAL	37
---------------------	-----------

MENU OPTIONS	38
---------------------------	-----------

Record menu	38
Image size	38
Quality	38
Exposure	38
White balance	39
Digital zoom	39
ISO	39
Quick view	40
LCD brightness	40
Movie menu	40
Playback menu	41
Protect	41
Delete all	41
Slide show	41
LCD brightness	41
Copy to card	41
Setup menu	42
Format	42
Beep	42

Power off	42
Reset to default	43
Date type	43
Date setup	43
Date imprint	44
Video out	44
Language	44

CONNECTING THE CAMERA TO OTHER DEVICES

CAMERA SPECIFICATIONS

.....	46
--------------	-----------

INTRODUCTION

Overview

Your new digital camera delivers high quality, 2048x1536 resolution images using a 3.3-Megapixel CCD imager. Using either the optical viewfinder or the 1.5" TFT color image LCD monitor, you can compose images and then examine them in detail. An auto-flash sensor automatically detects the shooting (lighting) conditions and determines whether the flash should be used. This feature helps ensure that your images turn out right.

8MB internal (built-in) memory lets you capture and store images without the need for an additional memory card. However, you may wish to expand the memory capacity (up to 256MB capacity) by using an external memory card.

In addition to still images, you can record short videos using the movie function. Images you have taken can be downloaded to your computer using the USB cable (USB driver required for Win98 and Mac OS 8.6). You can enhance and retouch your images on your computer by using the provided editing software, or image editing software you may already own. You may share your images with your friends via e-mail, in a report, or on a website.

E

Package contents

Carefully unpack your package and make sure that you have the following items. In the event that any item is missing or if you find any mismatch or damage, promptly contact your dealer.

- Digital camera
- Video cable
- User's manual
- Quick guide
- USB cable
- Software CD-ROM
- Camera strap
- Camera pouch

Optional accessories

- SD memory card
(up to 256MB capacity)
- AC power adapter
- 2 x AA alkaline batteries

GETTING TO KNOW THE CAMERA

Front view

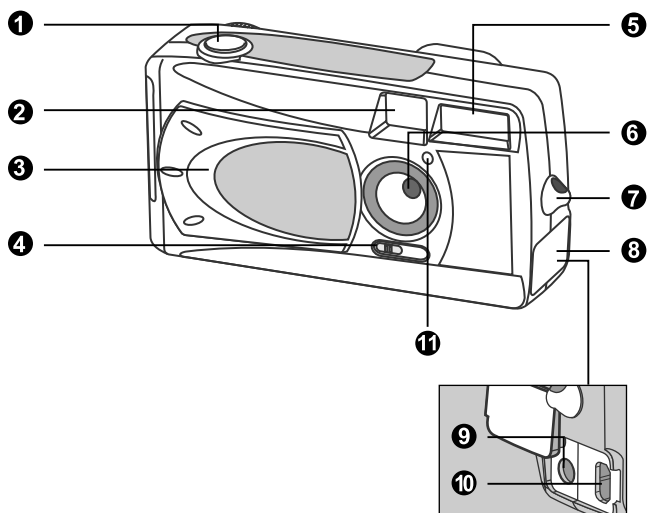

E

1. Shutter button

2. Viewfinder window

3. Lens cover

4. Focus switch

👉 Macro mode

👤 Portrait mode

🏞 Landscape mode

5. Flash

6. Lens

7. Strap eyelet

8. Jack cover

9. DC IN jack

10. USB connector

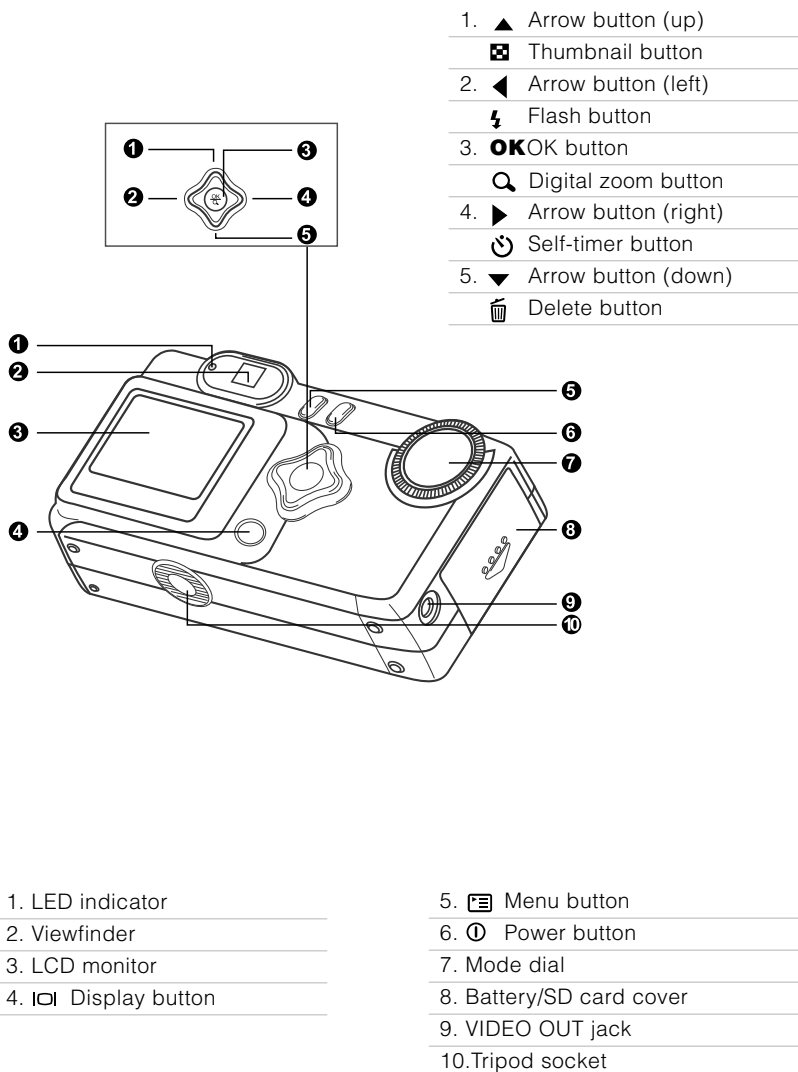

11. Self-timer lamp

Rear view



1. ▲ Arrow button (up)
- ☒ Thumbnail button
2. ◀ Arrow button (left)
- ⚡ Flash button
3. **OK** OK button
- 🔍 Digital zoom button
4. ▶ Arrow button (right)
- ⌚ Self-timer button
5. ▼ Arrow button (down)
- 🗑 Delete button

1. LED indicator
2. Viewfinder
3. LCD monitor
4.  Display button

5.  Menu button
6.  Power button
7. Mode dial
8. Battery/SD card cover
9. VIDEO OUT jack
10. Tripod socket

Mode dial

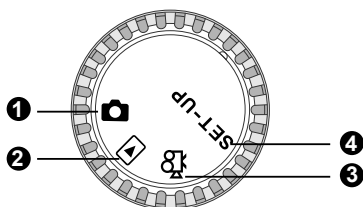

	Mode	Description
1.	Record Mode	Use this mode to capture still images.
2.	Playback mode	Use this mode to view images / video clips, delete images / video clips, view a slide show, or view thumbnail displays.
3.	Movie mode	Use this mode to record video (movie) clips.
4.	SET-UP Setup mode	Use this mode to adjust camera settings.

LED indicators

Indicator	Status	Description/Activity	Sound
LED Indicator	Solid red	The camera is powering up.	No
LED Indicator	Blinking red	Camera system error	Yes *(3)
LED Indicator	Solid red	Charging the flash	No
LED Indicator	Blinking red	Image is being recorded to the memory card.	No
LED Indicator	Blinking red	USB communication/transfer in progress	No
LED Indicator	Solid green	The camera is ready to record images (or movies).	Yes *(1)
Self-timer Indicator	Blinking red	The self-timer function is activated.	Yes *(1)
—	—	Error message	Yes *(3)
—	—	Valid button event	Yes *(1)

*(1) The camera sounds one beep.

*(3) The camera sounds three beeps.

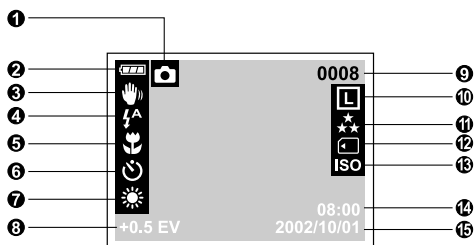

LCD monitor information

These indicators are displayed when recording still images:







1. Record mode

2. Battery level

-  Full battery power
-  Medium battery power
-  Virtually no battery power

3. Slow shutter speed warning

4. Flash mode





-  Auto flash
-  Red-eye reduction
-  Fill flash (on)
-  Flash off

5. Macro mode

6. Self-timer mode

7. White balance



(no indication for auto white balance)

-  Daylight
-  Cloudy
-  Sunset
-  Tungsten
-  Fluorescent



8. EV compensation

9. Possible number of shots (at the current size and quality settings)

10. Image size

-  2048 x 1536 pixels
-  1024 x 768 pixels
-  640 x 480 pixels

11. Image quality

-  Super fine
-  Fine
-  Normal

12. Card indicator

13. ISO speed

- AUTO
- 100
- 200
- 400

14. Time (24-hour-format)



15. Date (year-month-day)

E

These indicators are displayed when recording video clips:

1. Movie mode

2. Battery level

-  Full battery power
-  Medium battery power
-  Virtually no battery power

3. Recordable movie time

4. Card indicator

5. Time (24-hour-format)

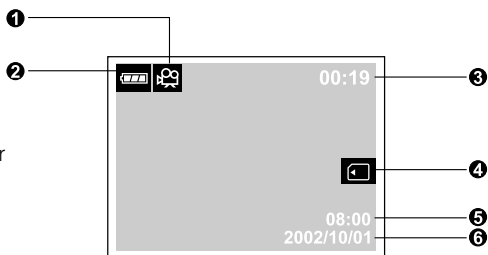

6. Date (year-month-day)



E

These indicators are displayed when playing images back:

1. Battery level

-  Full battery power
-  Medium battery power
-  Virtually no battery power

2. Protect indicator

3. Folder number and image number

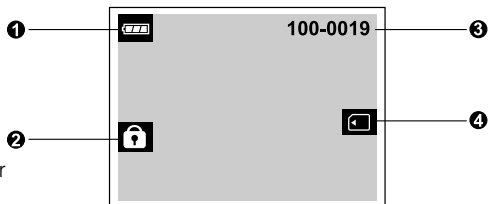

4. Card indicator



These indicators are displayed when playing video clips back:

1. Movie mode

2. Battery level

-  Full battery power
-  Medium battery power
-  Virtually no battery power

3. Count

4. Folder number and image number

5. The first frame of the movie

6. Card indicator

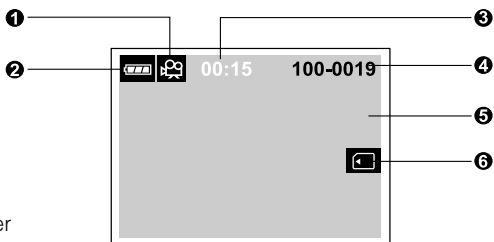

GETTING STARTED

You can use either 2 AA size batteries (Alkaline, Ni-MH) or an AC power adapter (optional accessory) to power the camera. Battery power is convenient for recording images or video clips while AC adapter power is recommended for transferring images to your computer.

Installing the batteries

1. Make sure the camera is off.
2. Slide the battery/SD card cover in the direction of the OPEN arrow.
3. Insert the batteries according to the correct polarity marks (+ or -).
4. Close the battery/SD card cover firmly.

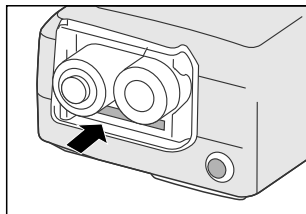

NOTE

- If you won't be using the batteries for an extended period of time, remove them from the camera to prevent leaks or corrosion.
- Never use manganese batteries.
- Never use different types of batteries (together) or mix old and new batteries.
- Avoid using the camera in extremely cold environments. Otherwise, it may damage the camera. (Such damage is not covered under the warranty.)

Using the AC power adapter (optional accessory)

1. Make sure the camera is off.
2. Open the jack cover and connect one end of the AC power adapter to the DC IN jack on the camera.
3. Connect the other end to an electrical outlet.

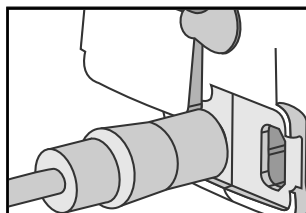

NOTE

- Make sure to use only the specified AC power adapter for the camera. Otherwise, it may cause damages to the camera, which is not covered under the warranty.
- To prevent unexpected auto power off resulting from no battery power left during the process of transferring your images to the computer, use the AC power adapter as a power supply.

Loading an SD memory card (optional accessory)

The camera comes with 8MB of internal memory, allowing you to store images and video clips in the camera. However, you can expand the memory capacity by using an optional SD memory card so that you can store additional images and video clips.

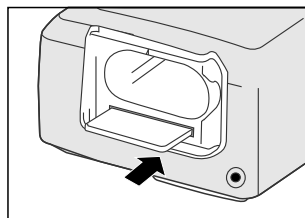

1. Make sure the camera is off.
2. Slide the battery/SD card cover in the direction of the OPEN arrow.
3. Insert the SD memory card.
 - The front side of the memory card (printed arrow) should face towards the front side of the camera.
 - If the card cannot be inserted, check the orientation.
4. Close the battery/SD card cover.
 - To remove the SD memory card, make sure the camera is off. Open the battery/SD card cover. Press lightly on the edge of the memory card and it will eject.



NOTE

- To prevent valuable data from being accidentally erased from an SD memory card you can slide the write-protected tab (on the side of the SD memory card) to "LOCK".
- To save, edit, or erase data on an SD memory card, you must unlock the card.

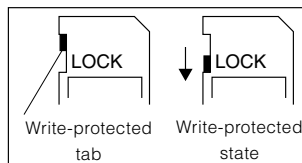

Attaching the strap

To prevent accidental slippage during the use, always use the strap.

1. First thread the small loop of the wrist strap through the strap eyelet on the camera and then pull the large loop through the small loop until the strap is firmly secured.

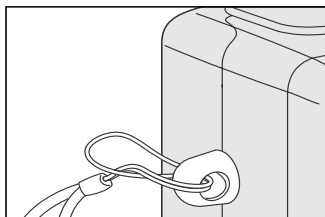

Choosing the language

When you first turn the camera on, the language setting screen appears, prompting you to choose a language for displayed information on the LCD monitor. Follow the steps below to set the OSD (On-Screen Display) language.

1. Select a language that you prefer by using the ▲ / ▼ button.
2. Press the **OK** button to confirm.

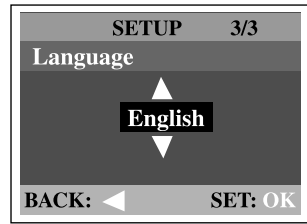

NOTE

- The language setting will be retained even if the camera is turned off.
- The provided languages are [English], [Français], [Deutsch], [Español], [Portugués], [Italiano], [日本語], [繁體中文], and [简体中文].

E

Setting the date and time

The Date/Time screen will be presented if/when:

- Camera is turned on for the first time (after setting the language)
- Camera is turned on after removing the batteries/AC power adapter or replacing the batteries.

When the date and time setting screen appears, follow these steps to set the correct date and time. You may skip this procedure by pressing **OK**.

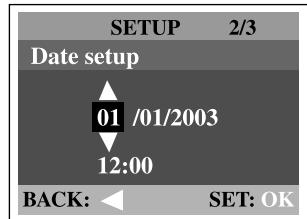









1. Enter the values of the year, month, day and time fields by using the ▲ / ▼ button. Press **OK** after all field is set.
 - To increase a value, press the ▲ / ► button.
 - To decrease a value, press the ▼ / ◀ button.

Setting the image resolution and quality

Resolution and quality settings determine the pixel size (dimension), image file size, and compression ratio for your image. These settings affect the number of images that can be stored in internal memory, or on an SD memory card.







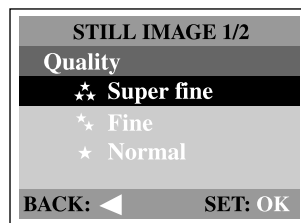
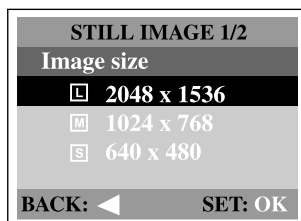





Higher resolution and higher quality images offer the best photographic results but take up more memory space. High resolution/quality settings are recommended for printed output and situations requiring the finest detail. Lower resolution/quality images take up less memory space and may be quite suitable for sharing images via e-mail, in a report, or on a web page.

To change image resolution or image quality, perform the steps below:

1. Turn the mode dial to  mode and power on the camera.
2. Press the  button on the rear side of the camera.
 - The Record menu appears.
3. Select Image size or Quality by using the  /  button.
4. Press the  button. Select the image size or image quality you prefer by using the  /  button.
5. Press **OK** to confirm. To exit the menu screen, press the  button.



The table below shows the approximate number of shots that you can take at each setting based on 8MB internal memory or an 8MB SD memory card.

Resolution	Quality	Compression ratio	8MB internal memory
 2048x1536 pixels	 Super Fine	4:1	3
	 Fine	8:1	6
	 Normal	12:1	9
 1024x768 pixels	 Super Fine	4:1	12
	 Fine	8:1	24
	 Normal	12:1	36
 640x480 pixels	 Super Fine	4:1	30
	 Fine	8:1	60
	 Normal	12:1	90



* The above data shows the standard testing results. The actual capacity varies according to the shooting conditions and settings.

RECORD MODE

Taking pictures

Your camera is equipped with both an optical viewfinder and a 1.5" LCD monitor to compose images. Taking images using the optical viewfinder will conserve battery power. If your batteries are low, it is recommended that you only compose images by using the viewfinder. The LCD monitor can help you accurately compose pictures and examine all details, but using it also consumes more battery power. However, always use the LCD monitor for macro shots to avoid parallax effects.

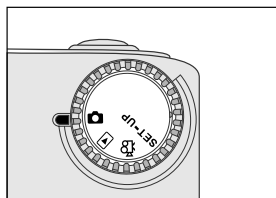

Using the viewfinder

1. Open the lens cover.
2. Turn the mode dial to  mode.
3. Turn the camera on by pressing the  button.
4. Compose the picture in the viewfinder.
5. Press the shutter button.
 - The LED indicator blinks red while the camera is processing a captured image.





E

Using the LCD monitor

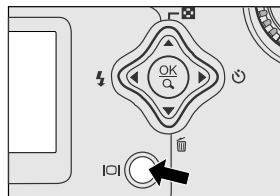
1. Open the lens cover.
2. Turn the mode dial to  mode.
3. Turn the camera on by pressing the  button.
4. Turn the LCD monitor on by pressing the  button.
5. Compose the picture.
6. Press the shutter button.
 - The LED indicator blinks red while the camera is processing a captured image.





NOTE

- By pressing the  button repeatedly in  mode when quick view is ON, the LCD status will change cyclically.
LCD on and OSD → LCD on → LCD off
↑
- The image on the LCD monitor darkens when in strong sunlight or bright light. This is not a malfunction.
- Using the LCD monitor for an extended period of time may reduce the number of shots you can take. To conserve battery power and increase the number of shots you can take, turn the LCD monitor off and use the viewfinder instead.
- Always use the image LCD for macro shots.
- The LCD monitor must be on when Digital zoom is to be used.

Using the portrait mode

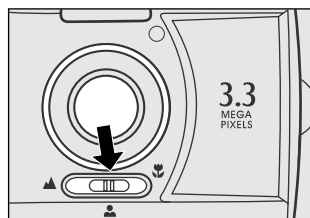

Taking pictures by selecting the portrait mode will produce an image with sharp subject and indistinct background. The effective range is between 0.9m and 1.9m.

1. Open the lens cover, turn the mode dial to  mode, and power on the camera.
2. Move the focus switch located on the front side of the camera to the  position.
3. Compose the picture.
4. Press the shutter button.



Using the landscape mode

The landscape mode, suitable for scenery shooting, is used when the distance to the subject is between 1.9m and infinity.

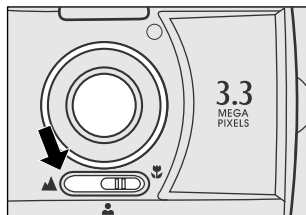

1. Open the lens cover, then the mode dial to  mode, and power on the camera.
2. Move the focus switch located on the front side of the camera to the  position.
3. Compose the picture.
4. Press the shutter button.



E

Using the digital zoom

By using the digital zoom, images can be enlarged so that the subject appears closer. However, the more the image is enlarged, the grainier the image will become. The digital zoom function is only available when you set the LCD monitor and the digital zoom to ON. To capture a digitally zoomed image, perform the following steps:

1. Open the lens cover, turn the mode dial to  mode, and power on the camera.
2. Turn the LCD monitor on by pressing the  button.
3. Press **OK** to activate 2X digital zoom function.
 - The 2X icon appears on the LCD monitor.
 - To cancel the digital zoom function, press **OK** again.
4. Press the shutter button to capture a "zoomed" image.





NOTE

- You can only set the digital zoom at the resolution of 2048x1536 pixels; digital zoom is not available at the resolution of 1024x768 pixels and 640x480 pixels. When you play back a "digitally zoomed" image, the image size is 1024x768 pixels.
- The more the image is enlarged, the more pixelated (grainier) the image.
- Digital zoom cannot be used in movie mode.

Using the self-timer

The self-timer duration is 10 seconds. After the activation of the self-timer by pressing the shutter button, the self-timer lamp starts blinking slowly for 7 seconds and then blinking faster for the rest of 3 seconds. This allows you to get into the scene when taking group images.

1. Secure the camera to a tripod or place it on a stable surface.
2. Open the lens cover, turn the mode dial to  mode, and power on the camera.
3. Press the  button.
 - The  icon appears on the LCD monitor .
4. Compose the picture.
5. Press the shutter button.
 - The self-timer function is activated.
6. After ten seconds, the camera takes an image.
 - To cancel self-timer photography at any time, press the self-timer button to disrupt the sequence.

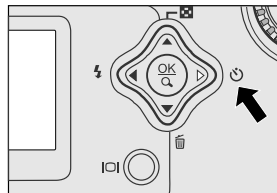



E

NOTE

- After one shot is taken, the self-timer mode is turned to off.

Using the macro mode

Use the macro mode to shoot a close-up of the subject, such as flowers or insects. The effective range is between 0.55m and 0.9m.

1. Open the lens cover, turn the mode dial to  mode, and power on the camera.
2. Move the focus switch located on the front side of the camera to the  position.
 - The  icon appears on the LCD monitor .
3. Compose the picture.
4. Press the shutter button.
 - To disable macro photography, slide the focus switch back to portrait mode or landscape mode.

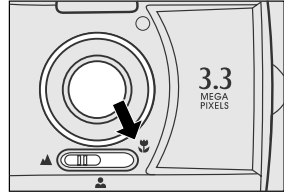

E





NOTE

- When shooting a close-up in macro mode, use the image LCD monitor to compose your shot, avoiding the off-center parallax phenomenon.
- After a macro shot is taken DO NOT FORGET to reset the lens to the normal position.



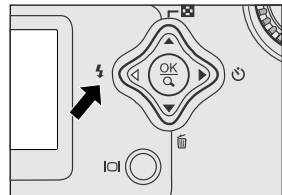

Using the flash

The flash is designed to function automatically when lighting conditions warrant the use of flash. You can take an image using a flash mode suitable to your circumstances. If you change the flash mode, the camera will retain that setting even if the camera is turned off.

1. Open the lens cover, turn the mode dial to  mode, and power on the camera.
2. Press the  button located on the rear side of the camera repeatedly until your desired flash mode appears on the LCD monitor.
3. Compose the picture and press the shutter button.







The camera has four flash modes: Automatic Flash (default), Red-Eye Reduction, Fill Flash (on), and Flash Off. The modes appear cyclically when you press the  button on the rear side of the camera. The table below will help choose the appropriate flash mode:

Flash Mode	Description
[] Auto Flash	The flash fires automatically according to the ambient conditions. Select this mode for general photography.
[] Red-eye Reduction	The flash emits a precursor-flash before the main flash fires. This causes the pupil in the human eye to constrict, reducing the red-eye. Select this mode when taking pictures of people and animals in low-light conditions.
[] Fill Flash (on)	The flash will always fire regardless of the surrounding brightness. Select this mode for recording images with high contrast (backlighting) and deep shadows. Also known as forced flash.
[] Flash Off	The flash will not fire. Select this mode when taking images in a place where flash photography is prohibited, or when the distance to the subject is beyond the effective range of the flash.

Taking pictures manually

You can manually adjust conditions such as EV compensation, white balance, or ISO speed when taking pictures. For EV compensation, white balance, or ISO speed information, refer to Exposure, White balance, or ISO in the Record menu.

To take pictures manually:

1. Open the lens cover, turn the mode dial to  mode, and power on the camera.
2. Press the  button.
3. Move to Exposure, White balance, or ISO by using the  button.
4. Press the  button to enter the sub-menu.
5. Change the settings by using the  button and then press **OK**.
6. Compose the picture.
7. Press the shutter button.









E

PLAYBACK MODE

In  mode, you can view, magnify, delete images, play video clips, or run a slide show. Playback mode also provides a thumbnail image display, allowing you to quickly scan for the image you want.

Viewing images

You may view your images without opening the lens cover since the lens is not used for playback. The camera lens is protected during playback.

1. Turn the mode dial to  mode and power on the camera.
2. Select the image that you want to view by using the  /  button.
 - To view the previous image, press the  button.
 - To view the next image, press the  button.
 - Pressing the  button displays the detailed information for the captured image, such as image size, ISO speed, TV, AV, Date.

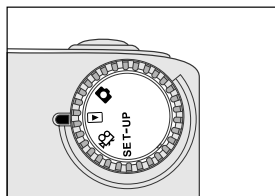







NOTE

- If there is no image stored in the internal memory or on the memory card, "❗ No image!" will appear on the LCD monitor.
- You can also view your images on the TV screen. Connect one end of the video cable to the video out jack of the camera and connect the other end to the video input of your TV. Turn the mode dial to  mode and then turn on both TV and camera.

Zoom playback



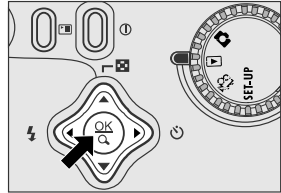

While reviewing your images, you may enlarge a selected portion of an image. This magnification allows you to view fine details.

1. Turn the mode dial to  mode and power on the camera.
2. Select the image that you want to view by using the /  button.
3. Enlarge the image by pressing **OK**.
 - Pressing **OK** once magnifies the image to 2X. Pressing it again magnifies the image to 4X.
4. To view the different portion of the enlarged image, press the / / /  button.
5. To return to the regular display from 4X-enlarged status, press **OK** again.



Displaying thumbnail images

This function allows you to view nine thumbnail images on the LCD monitor simultaneously so you can quickly scan for a particular image.



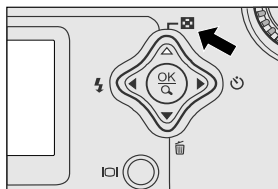





1. Turn the mode dial to the mode and power on the camera.
2. Press the  button.
 - Nine thumbnail images appear on the LCD monitor (assuming there are nine or more images in the memory).
 - To view a full-sized image, press **OK** after selecting it by using the  /  /  /  button.



E

Slide show display

The slide show function enables you to play your images back automatically in sequential order as a slide show. This is a very useful and entertaining feature for reviewing recorded images and for presentations.

1. Turn the mode dial to  mode and power on the camera.
2. Press the  button and move to Slide show by using the  /  button.
3. Press the  button.
4. Set the playback interval by using the  /  button and then press **OK**.
 - The slide show starts, displaying your images on the LCD monitor one by one with the set interval.
 - To stop the slide show display, press the  /  button.

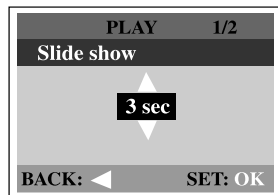













NOTE

- You can adjust the slide show display interval within the range of 1 sec. to 9 sec. in 2 sec. step.

Protecting one image/video clip



You can protect the image/video clip you prefer from being accidentally erased by using the protect function in the Playback menu. Follow the steps below to perform protect function:

Protecting one image/video clip

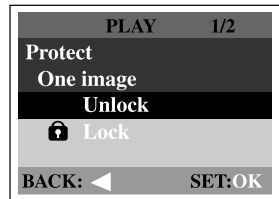
1. Turn the mode dial to  mode and power on the camera.
 - The last image/video clip appears on the LCD monitor.
2. Select the image/video clip you wish to protect by using the /  button.
3. Press the  button. Select Protect by using the /  button.
4. Press the  button. Use the /  button to select One image and then press the  button.
 - To protect all images, select All images in this step.
5. Select Lock by pressing the /  button and then press OK.
 - Once the image/video clip is protected, the protection icon will display on the protected image/video clip.



Removing protection from one image/video clip

1. Perform the steps above 1 to 4 in "Protecting one image/video clip".
2. Select Unlock by pressing the /  button and then press OK.









NOTE

- To erase the protected image/video clip, use the format function. For more information about formatting, refer to Format in the Playback menu.

Deleting images/video clips







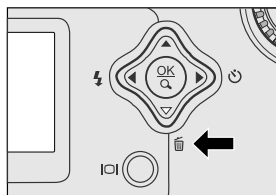

To delete one image/video clip at a time, use the  button on the rear side of the camera. To delete all images/video clips at once, go to Delete all in the Playback menu.

To delete one image/video clip at a time:

1. Turn the mode dial to  mode and power on the camera.
2. Select unwanted image/video clip by using the /  button and then press the  button.
3. When delete message appears, select [Yes] by using the /  button and then press **OK**.
 - The next image/video clip appears.
 - If you want to cancel the deletion, select [No].
4. Continue the deletion if necessary. If all images are deleted, [ No image !] will pop up. To exit this screen, turn the mode dial to the other mode.



To delete all images/video clips at once:

1. Turn the mode dial to  mode and power on the camera.
2. Press the  button on the rear side of the camera.
3. Select Delete all by using the /  button.
4. Press the  button.
5. Select [Yes] by using the /  button and then press **OK**.
 - A progress bar displays, showing the process of deletion. After that, [ No image!] pops up. Turn the mode dial to the other mode to exit the screen.

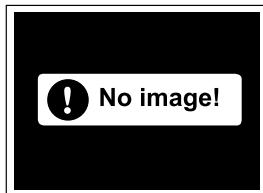

NOTE

- To delete the image or video clip stored in the internal memory, remember not to insert the memory card in the camera. Otherwise, you will delete the image or video clip stored in the memory card.

MOVIE MODE

Recording video clips

The movie mode allows you to record video clips at the resolution of 320 x 240 pixels.

1. Open the lens cover, turn the mode dial to  mode, and power on the camera.
 - The recordable movie time displays on the LCD monitor.
2. You can start recording a video clip by pressing the shutter button.
 - The elapsed time displays on the LCD monitor while recording a video clip.
 - To stop recording, press the shutter button again.

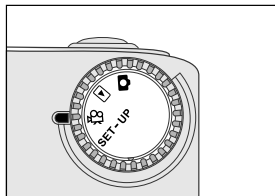

E









NOTE

- In movie mode, resolution/quality, self-timer cannot be set or activated.
- In movie mode, the flash mode is automatically set to [OFF].

Viewing video clips

To view the recorded video clips, follow the steps below.

1. Turn the mode dial to  mode and power on the camera.
2. Select the video clip that you want to view by using the   button.
3. Press **OK** to start.
 - To pause playback at any time, press **OK** again.
 - To stop playback, press the   button.

Pressing **OK** or the   button while playing back the video clip will change the status as follows:

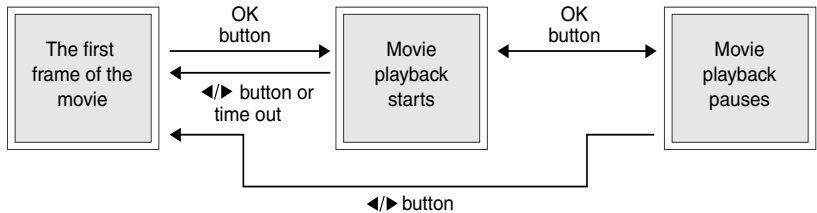

NOTE

- The zoom function cannot be activated while playing the video clip back.
- To play the video clip back on the computer, we recommend that you use the "QuickTime Player". This software is free of charge, compatible with Mac- and Windows- computers and can be downloaded from the Apple Web site at www.apple.com. For QuickTime Player usage, please refer to its on-line help for more information.

TRANSFERRING RECORDED IMAGES TO YOUR COMPUTER

You can share recorded images/video clips with your family or friends via e-mail or post them on the Web. Before doing those things, you need to connect the camera to your computer by using the USB cable and then transfer the images/video clips.

To transfer images/video clips from the camera to your computer, follow the steps below.

Step 1: Installing the USB driver

Step 2: Connecting the camera to your computer

Step 3: Downloading images/video clips

	System requirements (Windows)	System requirements (Macintosh)
CPU	Pentium 166 MHz processor or higher	PowerPC G3/G4
OS	Windows 98/98SE/Me/2000/XP	OS 8.6 or later
Memory	32MB RAM (64MB recommended)	32MB RAM (64MB recommended)
Free Space on Hard Disk	128MB hard disk space	128MB hard disk space
Required Devices	A CD-ROM drive, An available USB port	A CD-ROM drive, An available USB port
Color Monitor	Color monitor (800x600, 24-bit or higher recommended)	Color monitor (800x600, 24-bit or higher recommended)

E

Step 1: Installing the USB driver on Windows computers

The USB driver on the supplied CD-ROM is exclusively for Windows 98. Installing the USB driver on computers running Windows 2000/ME/XP is not necessary.

1. Insert the CD-ROM packaged with the camera into the CD-ROM drive. The welcome screen appears.
2. Click "Install USB Driver". Follow the on-screen instructions to complete the installation. After the USB driver installation is complete, restart your computer.



E

Installing the USB driver on Macintosh computers

Mac OS 8.6 users must install a USB driver. For Mac OS 9.0 or higher, the computer will automatically recognize the camera and load its own USB drivers.

1. Insert the CD-ROM packaged with the camera into the CD-ROM drive.
2. Select and double-click "Digital Camera Driver Installer".
3. Select "Install Location" and click "Install".
4. Follow the on-screen instructions to complete the installation and restart your computer.

Step 2: Connecting the camera to your computer

1. Connect one end of the USB cable to an available USB port on your computer.
2. Connect the other end of the USB cable to the USB connector on the camera.
3. Turn the camera on.
4. Look for a new "removable disk" icon appearing in the "My Computer" window. Your recorded images/video clips will be in a folder on this "removable disk". (For Mac users, double-click the "untitled" disk drive on the desktop.)

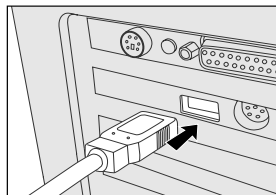

Step 3: Downloading images/video clips

When the camera is turned on and connected to your computer, it is recognized as a disk drive. You can download images/video clips by copying them from the "removable disk" ("untitled" disk on a Macintosh) to your hard drive or to another kind of disk.

For computers running Windows

Open the "removable disk" by double-clicking on it. Double-click on the folder contains your recorded images/video clips. Select the images/video clips that you prefer and choose "Copy" from the "Edit" menu. Then, open the destination location and choose "Paste" from the "Edit" menu.

For computers running Mac OS

Open the "untitled" disk window and the hard disk or the destination location. Drag and drop from the camera disk to the desired destination.



NOTE

- It is recommended that you use the AC power adapter as a power supply for the camera while transferring images/video clips from the camera to your computer since camera power may be cut off unexpectedly if the batteries run out.

INSTALLING MGI PHOTOSUITE

MGI PhotoSuite is a very user-friendly image-editing program. With PhotoSuite, you can breezily retouch, compose and organize your images. It contains a variety of templates, such as photo frames, birthday cards, calendars and more. Get your images ready and go explore this amazing program.

To install MGI PhotoSuite:

1. Insert the CD-ROM packaged with the camera into the CD-ROM drive. The welcome screen appears.
2. Click "Install MGI PhotoSuite". Follow the on-screen instructions to complete the installation.



E

NOTE

- For information on how to use MGI PhotoSuite to edit and retouch your recorded images, please refer to its online help.
- For Windows 2000/XP users, make sure to install and use the MGI PhotoSuite while logged in as a user with an Administrator account.
- PhotoSuite is not supported on the Mac.

INSTALLING MGI PHOTOVISTA

MGI PhotoVista is an easy-to-use program that lets you create spectacular 360° panoramic images in a snap. When you view these panoramas, you get the experience of being totally immersed in a realistic environment. PhotoVista's powerful engine quickly and automatically stitches images together, and its intuitive interface will let even a novice get great results in minutes.

To install MGI PhotoVista:

1. Insert the CD-ROM packaged with the camera into the CD-ROM drive. The welcome screen appears.
2. Click "Install MGI PhotoVista". Follow the on-screen instructions to complete the installation.

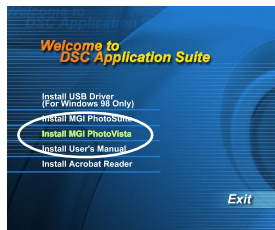

E



NOTE

- For information on how to use MGI PhotoVista to create spectacular 360° panoramic images, please refer to its online help.
- For Windows 2000/XP users, make sure to install and use the MGI PhotoVista while logged in as a user with an Administrator account.
- PhotoVista is not supported on the Mac.

INSTALLING ACROBAT READER

The supplied CD-ROM contains the user's manual in PDF format, allowing you to read and print if you have Acrobat Reader installed in your computer. Follow the steps below to install Acrobat Reader first.

1. Insert the CD-ROM packaged with the camera into the CD-ROM drive. The welcome screen appears.
2. Click "Install Acrobat Reader". Follow the on-screen instructions to complete the installation.

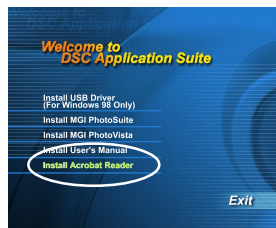

For Mac users:

E

1. Insert the CD-ROM packaged with the camera into the CD-ROM drive.
2. Select and double-click "Acrobat Reader".
3. Select and double-click the language that you prefer.
4. Double-click "Reader Installer".
5. Follow the on-screen instructions to complete the installation.

USING THE USER'S MANUAL

A copy of the user's manual is provided on the CD-ROM in PDF format. It is a backup copy of the printed manual. If you misplace the printed guide, you may print another copy from the CD-ROM. The only requirement for viewing the User's Manual on the CD-ROM is that you have Acrobat Reader installed in your computer.

1. Insert the CD-ROM packaged with the camera into the CD-ROM drive. The welcome screen appears.
2. Click "Install User's Manual". Follow the on-screen instructions to complete the installation.

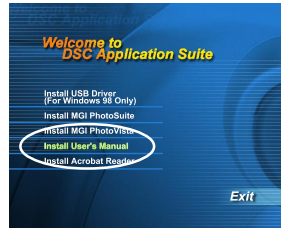

For Mac users:

1. Insert the CD-ROM packaged with the camera into the CD-ROM drive.
2. Select and double-click "Manual".
3. Select and double-click the language that you prefer.
4. Drag and drop the PDF file from the current location to the destination location.
5. View the user's manual by opening it.

E

MENU OPTIONS

Record menu





You can use the Record menu to select image size, image quality, or ISO speed. You can also adjust exposure, white balance, or LCD brightness in the Record menu. The Record menu even allows you to enable digital zoom or quick view function. To access the Record menu, turn the mode dial to  mode and then press the  button. Scroll through the menu options by using the / button.



Image size

For more information about setting image size, refer to "Setting the image size and quality".

Quality

E For more information about setting image quality, refer to "Setting the image size and quality".

Exposure

Your camera adjusts the exposure of each scene automatically. However, when the subject is too dark or too bright, the camera adjusts the brightness to make the subject appears brighter or darker. This is called EV compensation. The EV compensation of your camera can be adjusted from -1.8EV to +1.8EV. To select the EV compensation you wish, first press the  button. Then increase or decrease the EV compensation depending on what you need by using the  or the  button and press OK.

Effective Subjects and Set Values

Positive (+) Compensation

- Imaging of printed text (black characters on white paper)
- Backlit portraits
- Very bright scenes (such as snowfields) and highly reflective subjects
- Shots made up predominantly of sky

Negative (-) Compensation

- Spot lighted subjects, particularly against dark backgrounds
- Imaging of printed text (white characters on black paper)
- Scenes with low reflectivity, such as shots of green or dark foliage

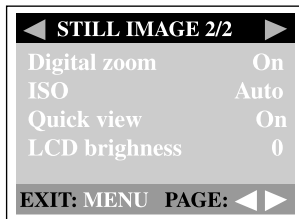
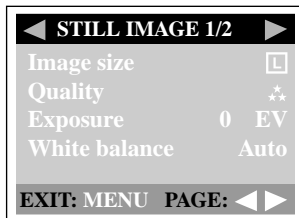

White balance

Your camera adjusts the white balance of each scene automatically. However, the images that your camera captures will appear different under different lighting conditions (daylight, cloudy, sunset, tungsten, fluorescent lights). Unlike your eyes, which can easily adjust to different lighting conditions (lighting temperatures), a digital camera cannot always differentiate between lighting types. Under some lighting conditions the image may appear in strange shades. If that occurs you may change the white balance setting by specifying a lighting condition (temperature) most appropriate for your scene. To set the white balance, first press the ► button. Then choose the white balance you prefer by using the ▲/ ▼ button and press OK.

[Auto]	: adjusts the white balance automatically
[☀ Daylight]	: records outdoors on a bright day
[☁ Cloudy]	: records under cloudy or shady sky
[🌅 Sunset]	: records a sunset
[💡 Tungsten]	: records under tungsten lighting condition
[💡 Fluorescent]	: records under fluorescent lighting condition

E

Digital zoom





You can take shots with the digital zoom by activating the digital zoom function. To enable this option, first press the ► button. Then select [On] by using the ▲/ ▼ button and press OK.

ISO



The ISO speed decides the sensitivity to the lights. The higher the ISO number is, the more sensitive it is to the lights. When recording under dark situations or recording a fast-moving subject, use a high-number setting. When recording high-quality images, use a low-number setting. To set the ISO speed, first press the ► button. Then choose the ISO speed you prefer by using the ▲/ ▼ button and press OK.

[Auto]	: adjusts the ISO speed automatically
[100]	: equivalent to ISO 100
[200]	: high-sensitive photography, equivalent to ISO 200
[400]	: high-sensitive photography, equivalent to ISO 400





Quick view

By enabling quick view, you can temporarily view the image on the LCD monitor right after you take a picture. After a temporary preview, the camera returns to  mode automatically. To enable quick view, first press the  button. Then select [On] by using the  /  button and press OK.

LCD brightness





This option adjusts the brightness of the LCD monitor. To adjust the LCD brightness, first press the  button. Then increase or decrease the LCD brightness depending on what you need by using the  or the  button and press OK.

E Movie menu

You can use the Movie menu to adjust exposure, white balance, ISO speed, or LCD brightness. To access the Movie menu, turn the mode dial to  mode and then press the  button. Scroll through the menu options by using the  /  button. For more information about Exposure, White balance, ISO, or LCD brightness, refer to its correspondent description in the Record menu.

MOVIE CLIP		
Exposure	0	EV
White balance	Auto	
ISO	Auto	
LCD brightness	0	
EXIT: MENU		

Playback menu

Use the Playback menu to create an on-camera slide show, or transfer images from internal memory to a memory card. You can also use the Playback menu to protect an image, delete all images at once, or adjust the LCD brightness. To access the Playback menu, turn the mode dial to  mode and then press the  button. Scroll through the menu options by using the  /  button.

Protect

Refer to "Protecting one image/video clip" in PLAYBACK MODE.

Delete all

Refer to "Delete images/video clips" in PLAYBACK MODE.

Slide show



Refer to "Slide show display" in PLAYBACK MODE.

LCD brightness

Refer to LCD brightness in the Record menu.

Copy to card

This feature allows you to copy your images from the camera's internal memory to a memory card. However, you can only do this when the memory card is installed and the internal memory contains images.

To perform this function, first press the  button. Then select [Yes] by using the  /  button and press OK. A progress bar displays, showing the process of copying.



E

Setup menu

You can select your preferences for the camera settings in SET-UP mode. Turn the mode dial to SET-UP mode and navigate to the option you wish to configure by using the ▲/▼ button.

Format

This option formats the internal memory (or memory card) and erases all stored images and data. To perform the format function, first press the ► button. Then select [Yes] by using the ▲/▼ button and press OK. A progress bar displays, showing the progress of formatting.

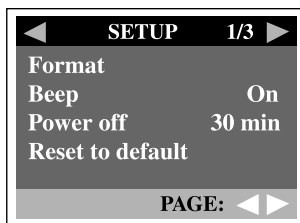

Beep

The camera makes a sound (beep) each time you press the camera button if this function is enabled. Press the ► button. Select [On] or [Off] by using the ▲/▼ button and then press OK.

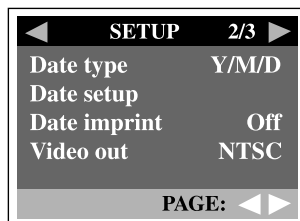

Power off

If the camera goes unused for a certain period of time while the camera is powered on, the camera will switch to an idle mode, and eventually turn itself off to conserve power.



Inactivity period (batteries)	Inactivity period (AC power adapter)	Camera status
60 seconds	60 seconds	stay idle
30 minutes	30 minutes	shut off

If the camera is idle, re-activate the camera by pressing any button or switch the mode dial. If the camera has powered-off you must turn the camera on again by pressing the Ⓚ button. The table (above) shows the default time settings for idle, and power-off. To change the power saving interval, first press the ► button. Then select the power-off interval you prefer by using the ▲/▼ button and press OK.

[3 min], [5 min], [10 min], [30 min]

Reset to default

If you wish to restore all camera settings to their original status, select this option and then press the ► button. Select [Yes] by using the ▲/ ▼ button and then press OK.

The table below shows the default setting for each item.

Item	Description
Image size	2048x1536 pixels
Image quality	★ Fine
Flash	Auto
LCD brightness	0
Quick view	On
White balance	Auto
EV compensation	0.0
Slide show delay	3 seconds
Auto power off	3 minutes
Beep	On

Date type

You can select the date type that is imprinted on your image. To set the date type, first press the ► button. Then select one date type you prefer by using the ▲/ ▼ button and press OK.

[Y/M/D]

[D/M/Y]

[M/D/Y]

Date setup

After removing the batteries from the camera, the date and time will return to the default setting. If this happens, reset the date and time when using the camera. For more information about the date setup, refer to "Setting the date and time".

Date imprint

If you set imprint function, your image will be displayed with date on it. To enable this function, first press the ► button. Then select [Yes] by using the ▲/ ▼ button and press OK.

Video out

You can view your images on a TV. Remember to select correct video output type according to where you locate. Otherwise, there will be white lines on a stored image. To set this option, first press the ► button. Then select the ▲/ ▼ button and press OK.

[NTSC] : select this format when located in the U.S.A., Canada, Japan, Korea, Taiwan, Central America, or Mexico.

[PAL] : select this format when located in Australia, Austria, Belgium, China, Denmark, Finland, Germany, Great Britain, Holland, Italy, Kuwait, Malaysia, New Zealand, Singapore, Spain, Sweden, Switzerland, Thailand, or Norway.

Language

This option allows you to select the language for the menus and the texts displayed on the LCD monitor. To set the language, refer to the section, "Choosing the language".

CONNECTING THE CAMERA TO OTHER DEVICES

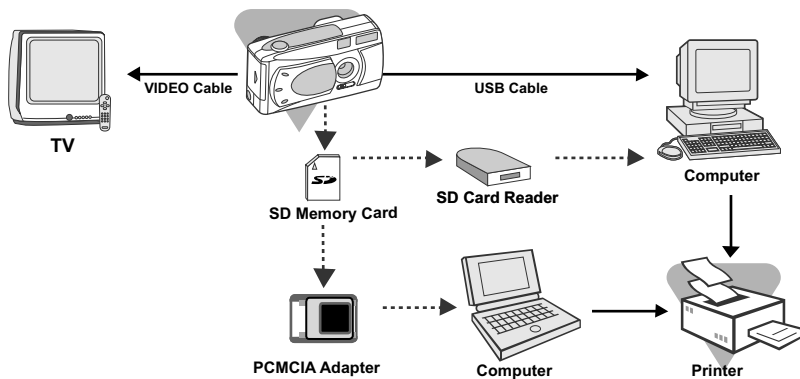

E

CAMERA SPECIFICATIONS

Item	Description
Image sensor	3.3-Megapixel CCD
Image quality	Super-Fine/Large (2048 x 1536 pixels) Fine/Medium (1024 x 768 pixels) Normal/Small (640 x 480 pixels)
Recording media	8MB internal memory; SD memory card (optional) (up to 256MB capacity)
Lens	Fixed focal length: 7.9mm Focusing range: Landscape---1.9m~infinity; Portrait---0.9m~1.9m; Macro---0.55m~0.9m F-number: 3.5
LCD monitor	1.5" color TFT LCD monitor
Self-timer	10-second delay
Zoom	2X digital zoom
Exposure compensation	Auto; Manual: -1.8 ~ +1.8EV (0.3EV step)
White balance	Auto; Manual: Daylight, Cloudy, Sunset, Tungsten, Fluorescent
Compressed format	JPEG, Motion JPEG for video clip
Standards	JPEG, EXIF 2.1, DCF 1.1, M-JPEG
Interface	DC IN jack, USB connector, VIDEO OUT jack (NTSC or PAL)
Operating environment	Operation: 0°C~40°C, 15%~90% humidity Storage: -20°C~80°C, 10~95% humidity
Power	2 x AA Alkaline batteries, 2 x AA Ni-MH batteries, AC power adapter
Tripod socket	Yes
Dimensions	105 x 41x 55 mm (W x H x D) (without protruding parts)
Weight	Approx. 120g (without batteries and the SD memory card)

*Design and specifications are subject to change without notice.

Free Manuals Download Website

<http://myh66.com>

<http://usermanuals.us>

<http://www.somanuals.com>

<http://www.4manuals.cc>

<http://www.manual-lib.com>

<http://www.404manual.com>

<http://www.luxmanual.com>

<http://aubethermostatmanual.com>

Golf course search by state

<http://golfingnear.com>

Email search by domain

<http://emailbydomain.com>

Auto manuals search

<http://auto.somanuals.com>

TV manuals search

<http://tv.somanuals.com>