

VIZIO



QUICK START GUIDE

Model: S5451w-C2

IMPORTANT SAFETY INSTRUCTIONS

Your Unit is designed and manufactured to operate within defined design limits, and misuse may result in electric shock or fire. To prevent your Unit from being damaged, the following rules should be observed for its installation, use, and maintenance. Please read the following safety instructions before operating your Unit. Keep these instructions in a safe place for future reference.

- Read these instructions.
- Keep these instructions.
- Heed all warnings.
- Follow all instructions.
- Do not use this apparatus near water.
- Clean only with a dry cloth.
- Do not block any ventilation openings. Install in accordance with the manufacturer's instructions.
- Do not install near any heat sources such as radiators, heat registers, stoves, or other apparatus (including amplifiers) that produce heat.
- Do not defeat the safety purpose of the polarized or grounding-type plug. A polarized plug has two blades with one wider than the other. A grounding type plug has two blades and a third grounding prong. The wide blade or the third prong are provided for your safety. If the provided plug does not fit into your outlet, consult an electrician for replacement of the obsolete outlet.
- Protect the power cord from being walked on or pinched, particularly at plugs, convenience receptacles, and the point where they exit from the apparatus.
- Only use attachments/accessories specified by the manufacturer.
- Use only with the cart, stand, tripod, bracket, or table specified by the manufacturer, or sold with the apparatus. When a cart is used, use caution when moving the cart/apparatus combination to avoid injury from tip-over.
- Unplug this apparatus during lightning storms or when unused for long periods of time.
- Refer all servicing to qualified service personnel. Servicing is required when the apparatus has been damaged in any way, such as when the power supply cord or plug is damaged, liquid has been spilled or objects have fallen into the apparatus, the apparatus has been exposed to rain or moisture, does not operate normally, or has been dropped.
- To reduce the risk of electric shock or component damage, switch off the power before connecting other components to your Unit.
- Unplug the power cord before cleaning your Unit. A damp cloth is sufficient for cleaning. Do not use a liquid or a spray cleaner on your Unit. Do not use abrasive cleaners.
- Always use the accessories recommended by the manufacturer to insure compatibility.
- When moving your Unit from an area of low temperature to an area of high temperature, condensation may form in the housing. Wait before turning on your Unit to avoid causing fire, electric shock, or component damage.
- Slots and openings in the back and bottom of the cabinet are provided for ventilation. To ensure reliable operation of your Unit and to protect it from overheating, be sure these openings are not blocked or covered. Do not place your Unit in a bookcase or cabinet unless proper ventilation is provided.
- Never push any object into the slots and openings on your Unit enclosure. Do not place any objects on the top of your Unit. Doing so could short circuit parts causing a fire or electric shock. Never spill liquids on your Unit.



- When connected to a power outlet, power is always flowing into your Unit. To totally disconnect power, unplug the power cord.
- Do not overload power strips and extension cords. Overloading can result in fire or electric shock.
- The wall socket should be located near your Unit and be easily accessible.
- Keep your Unit away from moisture. Do not expose your Unit to rain or moisture. If water penetrates into your Unit, unplug the power cord and contact your dealer. Continuous use in this case may result in fire or electric shock.
- Do not use your Unit if any abnormality occurs. If any smoke or odor becomes apparent, unplug the power cord and contact your dealer immediately. Do not try to repair your Unit yourself.
- Avoid using dropped or damaged appliances. If your Unit is dropped and the housing is damaged, the internal components may function abnormally. Unplug the power cord immediately and contact your dealer for repair. Continued use of your Unit may cause fire or electric shock.
- Do not install your Unit in an area with heavy dust or high humidity. Operating your Unit in environments with heavy dust or high humidity may cause fire or electric shock.
- Ensure that the power cord and any other cables are unplugged before moving your Unit.
- When unplugging your Unit, hold the power plug, not the cord. Pulling on the power cord may damage the wires inside the cord and cause fire or electric shock. When your Unit will not be used for an extended period of time, unplug the power cord.
- To reduce risk of electric shock, do not touch the connector with wet hands.
- Insert the remote control batteries in accordance with instructions. Incorrect polarity may cause the battery to leak which can damage the remote control or injure the operator.
- See the important note and rating located on the back of the unit.
- **WARNING** - This equipment is not waterproof. To prevent a fire or shock hazard, do not place any container filled with liquid near the equipment (such as a vase or flower pot) or expose it to dripping, splashing, rain, or moisture.
- **CAUTION** - Danger of explosion or fire if batteries are mistreated. Replace only with the same or specified type.
- Do not leave the batteries exposed to direct sunlight for a long period of time with doors and windows closed. Do not disassemble the batteries or dispose of it in fire.

WARNING: To reduce the risk of fire or electric shock, do not expose this apparatus to rain or moisture.



Explanation of WARNING symbols:



The lightning flash with arrowhead symbol within an equilateral triangle is intended to alert the user to the presence of not isolated dangerous voltage within the product that may be sufficient magnitude to constitute a risk of shock to persons.



The exclamation point within an equilateral triangle is intended to alert the user to the presence of important operating and servicing instructions in the literature accompanying the appliance.

TABLE OF CONTENTS

- Package Contents 4
- Controls & Connections 5
- First-Time Setup 8
- Connecting with HDMI 10
- Using the Remote..... 17
- Settings and LED Behavior..... 18
- Programming the Sound Bar..... 20
- Resetting to Factory Default Settings 21
- Bluetooth Pairing..... 22
- Using Bluetooth Mode 23
- Advanced Setup 24
- Wall Mounting the Sound Bar 26
- Re-linking the Subwoofer with the Sound Bar..... 28
- Wall Mounting the Satellite Speakers..... 29
- Help & Troubleshooting 31
- One-Year Limited Warranty 32
- Specifications..... 32
- Legal & Compliance 33

PACKAGE CONTENTS



High Definition Sound Bar with Wireless Subwoofer



2 x Satellite Speakers



Remote Control with Batteries

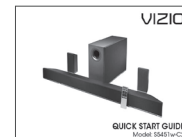

This Quick Start Guide



Digital Optical Cable



Stereo RCA to 3.5mm Audio Cable



Coaxial Audio Cable



2 x Satellite Speaker Audio Cables



2 x Power Cables



2 x Sound Bar Wall Mount Brackets



2 x Sound Bar Wall Mount Lugs (Size: M4 x 10)

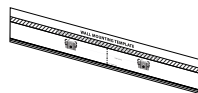

Wall Mount Template



HDMI Cable



2 x Satellite Speaker Wall Mount Lugs (Size: M4 x 8)



2 x Satellite Speaker Wall Mount Brackets

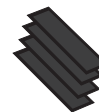

4 x Velcro Cable Ties

CONTROLS & CONNECTIONS

Back of Sound Bar

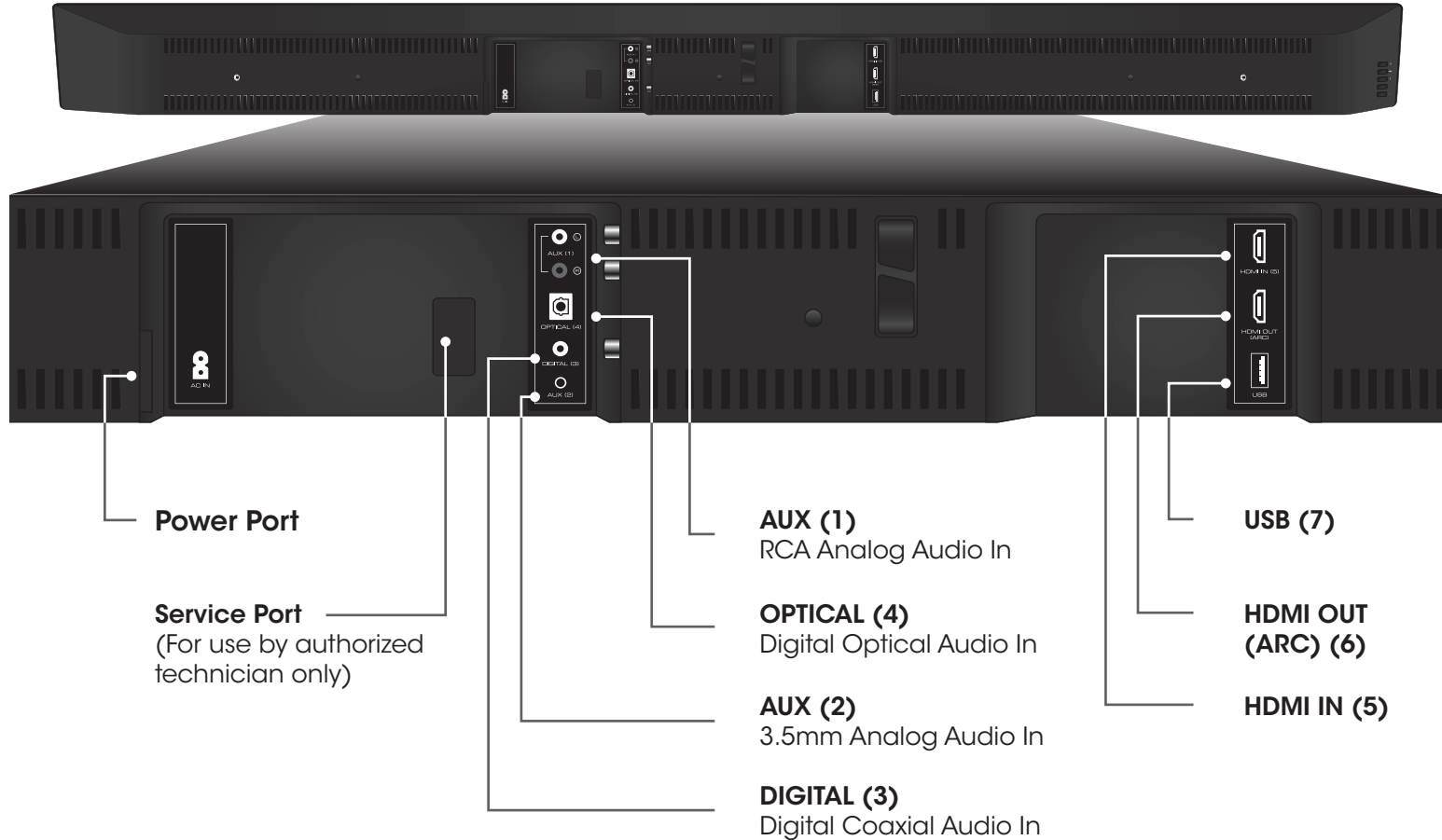



Control Buttons
are located here



Power

Input

Bluetooth Input

(Hold to pair device, See [Bluetooth Pairing](#) for more information.)

Volume

Back of Subwoofer

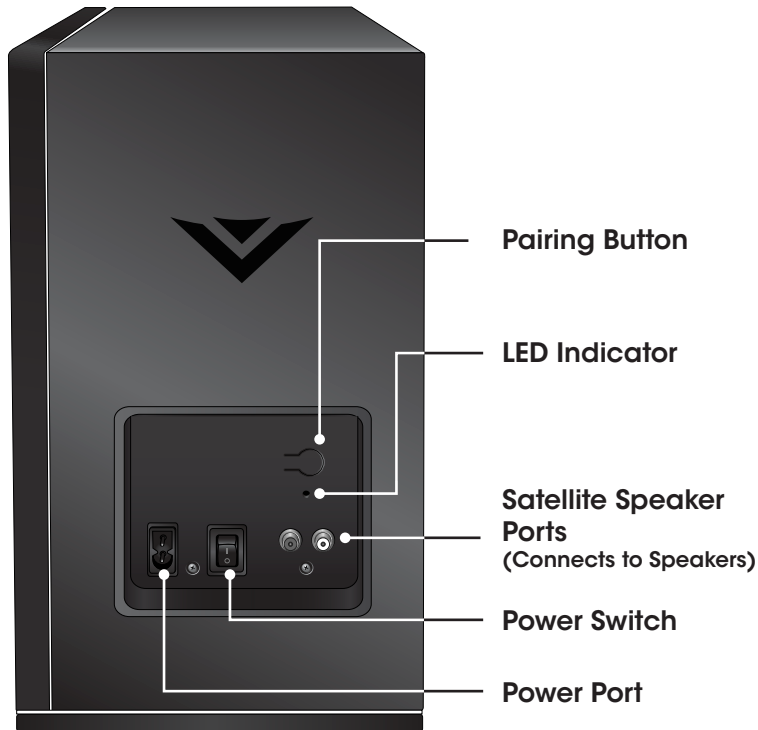

Back of Satellite Speaker



FIRST-TIME SETUP

Back of Sound Bar

1

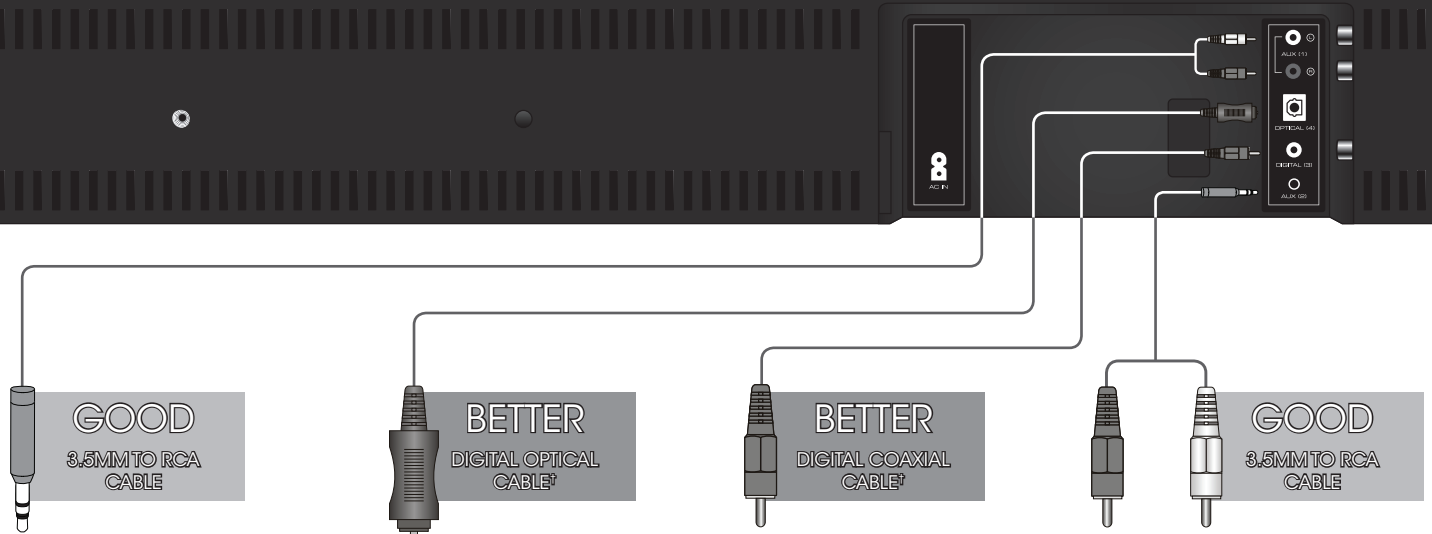

Note: Cables' appearance may differ from the ones supplied.

CHOOSE **ONE** CABLE:



AND CONNECT IT TO YOUR TV*



† When using the Digital Inputs, if there is no audio: (A) try setting the TV output to PCM on (B) Connect directly to your Blu-ray/other source, some TVs do not pass through digital audio. * Not all TVs have the audio outputs shown above. To connect the Sound Bar directly to your other devices (Blu-ray player, game system, etc) see your device's user manual.



HDMI cables send Video (Out) and receive Audio from the TV. See Connecting with HDMI on page 10 for more information.

Do not use HDMI IN for First-Time Setup.

See Advanced Setup if you would like to connect HDMI devices (such as Blu-ray™ players, cable boxes, and game consoles) to your Sound Bar.

Connect the **Sound Bar** to your **TV*** using **one** of the connection types to the left. Choose the best possible connection type. Be sure the TV port is an audio output, not an audio input.

† When using the Digital Inputs, if there is no audio: (A) try setting the TV output to PCM on (2). Connect directly to your Blu-ray/other source, some TVs do not pass through digital audio. [Download from www.Somanuals.com](http://www.Somanuals.com). All Manuals Search And Download

* Not all TVs have the audio outputs shown above. To connect the Sound Bar directly to your other devices (Blu-ray player, game system, etc.) see your device's user manual.

CONNECTING WITH HDMI

What is HDMI Audio Return Channel (ARC)?

Using HDMI ARC, your TV can send audio to the sound bar using an HDMI cable.

You will need to connect your sound bar to your TV's HDMI ARC port using an HDMI cable that is ARC compatible.

To connect using HDMI*:

1. Connect one end of the HDMI cable to the **HDMI 1 (ARC)** port on the back of your TV.
2. Connect the other end to the **HDMI OUT (ARC)** port on your VIZIO sound bar.
3. From the AUDIO menu on your TV, change the Digital Audio Setting to Dolby Digital or Bitstream.
4. From the AUDIO menu, disable the TV's internal speakers.
5. From the SYSTEM menu, enable CEC† Function.
6. From the CEC menu, select **Device Discovery** to register the sound bar with the TV.



If you want to use the volume buttons on the TV remote control to control the sound bar, enable System Audio Control from the CEC menu.

* The following steps are for use with a VIZIO TV, steps may differ by TV manufacturer. See your TV's user manual for more information.

† CEC Function naming may differ by TV manufacturer. See your TV's user manual for more information.



Connect to HDMI (ARC) port on your TV



* HDMI ARC port location may differ by TV manufacturer. See your TV's user manual for more information.
Download from www.Somanuals.com. All Manuals Search And Download.

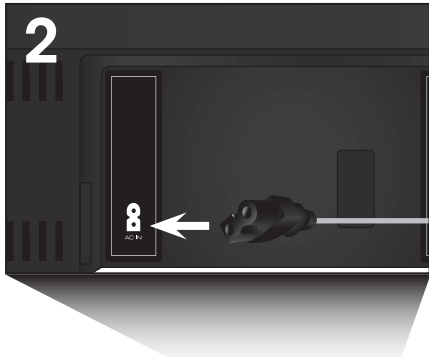

Connect the Power Cable to the back of the Sound Bar.



Plug the Power Cable into a power outlet.

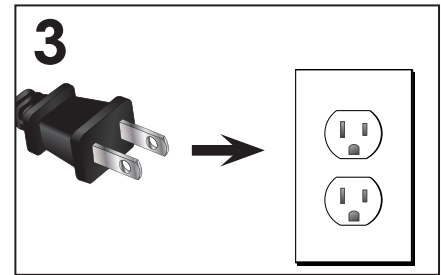

BACK OF SUBWOOFER

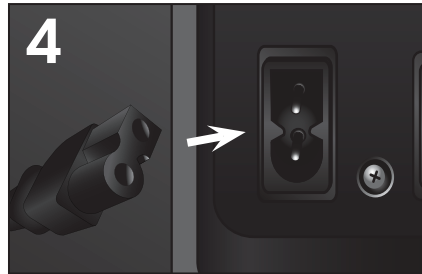

Connect a Power Cable to the Subwoofer.

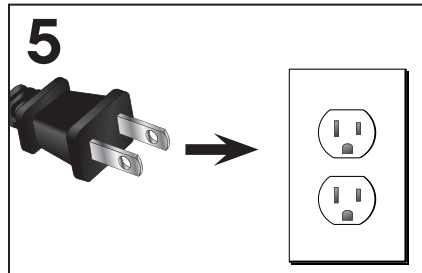

Plug the Power Cable into a power outlet.



Flip the Power Switch into the On position.

- 7** Connect the Satellite Speakers to the Subwoofer using the included Satellite Speaker Audio Cables.

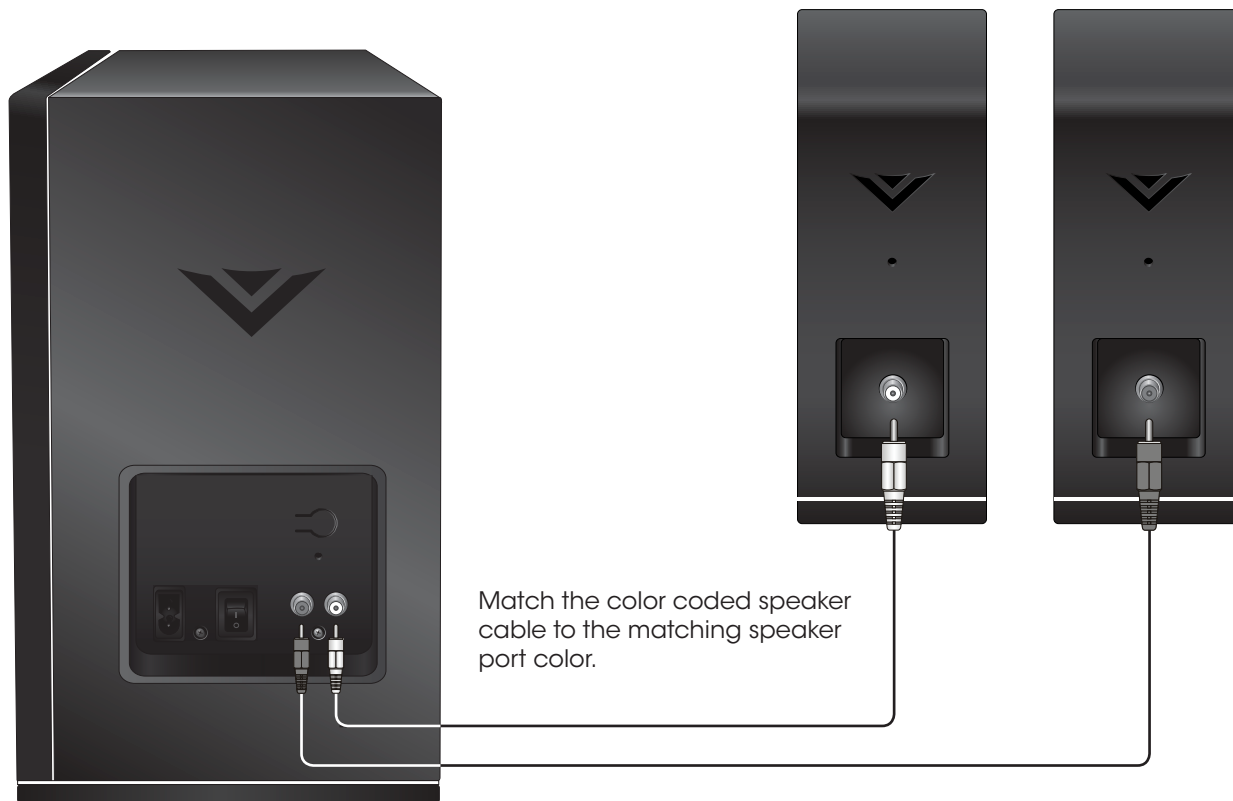

8

Sound Bar is centered
below the TV.

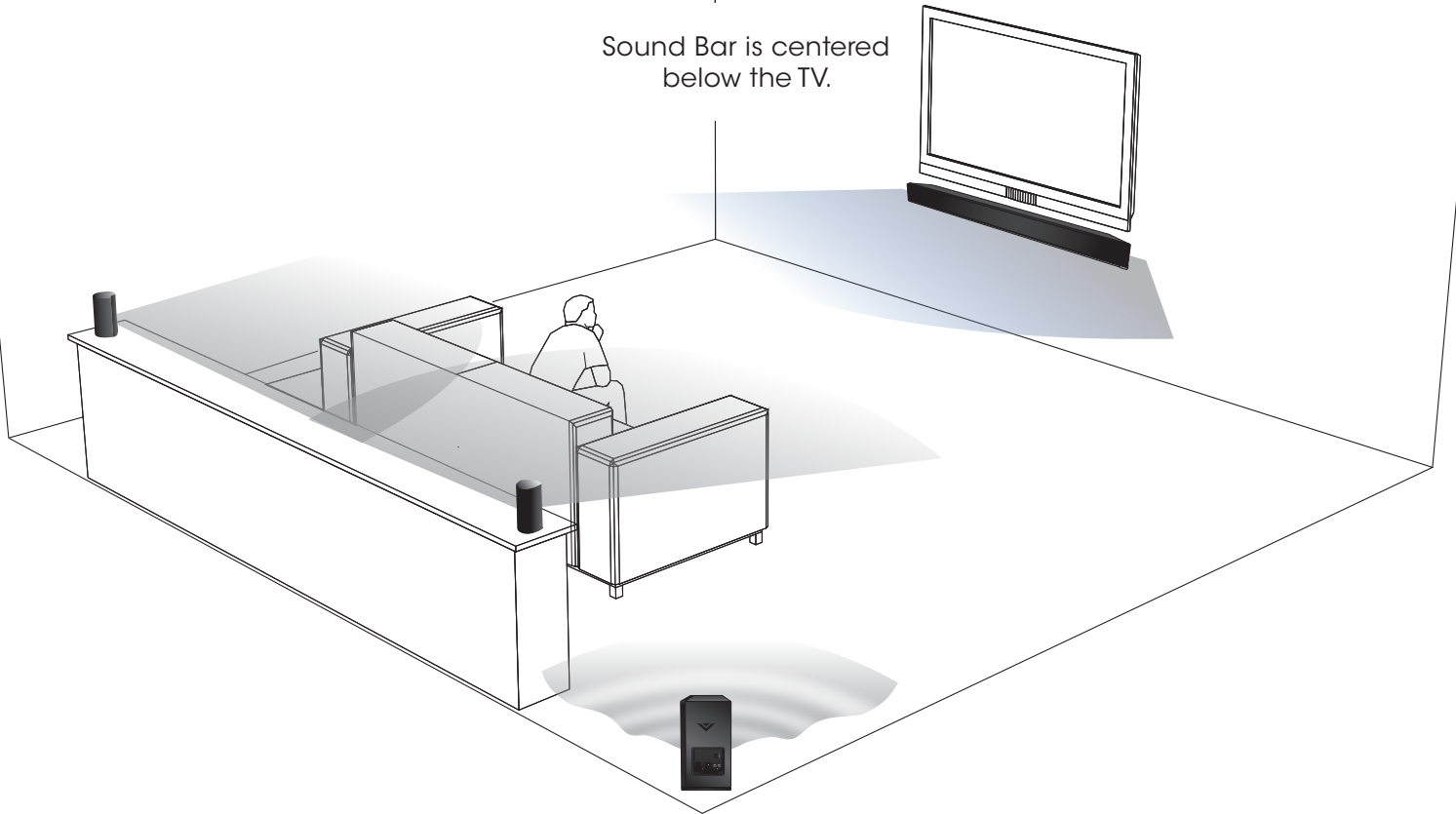

For the best surround sound experience, position the Sound Bar as shown.
The Sound Bar should be close to ear level.

- 9** Locate the arrow on the battery cover and gently slide it away from the remote with your thumb. Insert the included AAA batteries, matching the + and - symbols.

Gently slide the battery cover back in place.

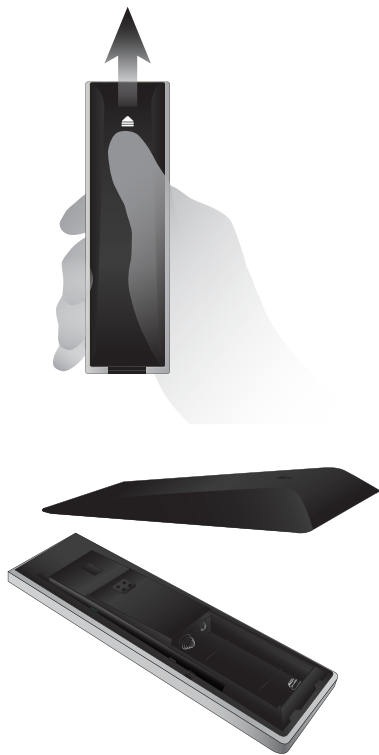

- 10** Turn your TV on, then press the **Power** button on the remote to turn the Sound Bar on.

Turn off the TV Speakers through the Settings Menu on your TV. See your TV's user manual for more information.

Press the **INPUT** button to switch between audio sources. For example, if you connected your TV to Input 1, set the Sound Bar to Input 1.

Hardware Setup is complete.

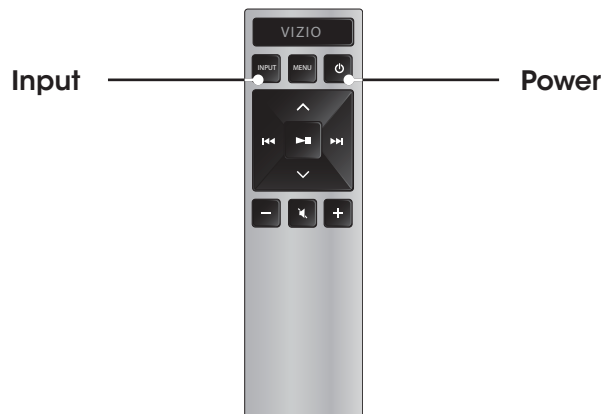

USING THE REMOTE

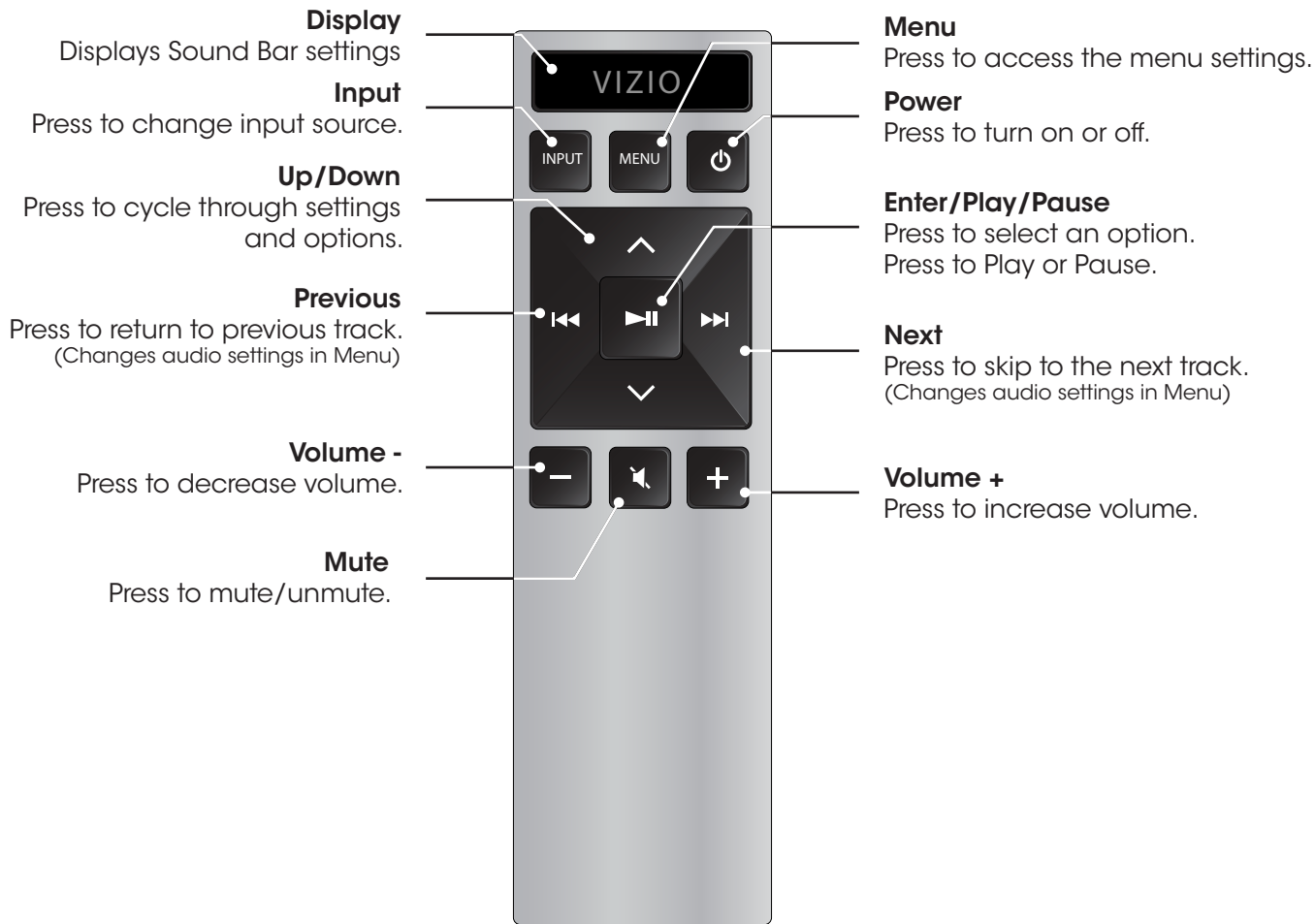



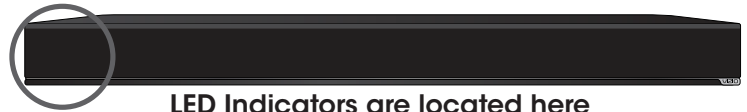



SETTINGS AND LED BEHAVIOR



LED Indicators are located here

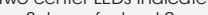

Press the **MENU** button and use the **Up/Down Arrow** buttons on the remote to access the different functions and acoustic settings of the Sound Bar. Each function and setting will be displayed on the remote control's LCD display. The LED Indicators will behave differently with each function.

| Function | LED Behavior | Description |
|--------------------------------------|---|--|
| Bluetooth Pairing BT Pair | (When searching for device) Flash from Left to Right and back continuously.  | Press the Play button on the remote. The Sound Bar will be discoverable for 15 minutes. You can now search for the Sound Bar (VIZIO S5451w) using your Bluetooth Device. The sound bar will power down if no device is found. Note: Set your Bluetooth device into pairing mode prior to the Sound Bar. |
| Bass Levels Bass | Two center LEDs indicate Bass level 0.  | Press the Next/Previous button to increase/decrease the bass level. The LED indicators will move to the right with increasing levels and to the left with decreasing levels. |
| Treble Levels Treble | Two center LEDs indicate Treble level 0.  | Press the Next/Previous button to increase/decrease the treble level. The LED indicators will move to the right with increasing levels and to the left with decreasing levels. |
| Center Levels Center | Two center LEDs indicate dialog is centered.  | Press the Next/Previous button to increase/decrease the presence of dialog in the center channel. The LED indicators will move to the right when the center level is increased and to the left when the center level is decreased. |
| Surround Levels Surround | Two center LEDs indicate surround levels are centered.  | Press the Next/Previous button to increase/decrease the surround sound level. The LED indicators will move to the right with increasing levels and to the left with decreasing levels. |
| Surround Balance Surr Bal | Two center LEDs indicate surround balance is centered.  | Press the Next/Previous button to increase/decrease the surround balance level on each side. The LED indicators will move to the right/left with balance levels for each side. |
| Subwoofer Levels Subwoofer | Two center LEDs indicate Subwoofer level 0.  | Press the Next/Previous button to increase/decrease the level of the subwoofer. The LED indicators will move to the right with increasing levels and to the left with decreasing levels. |

| Function | LED Behavior | Description |
|--|---|--|
| Surround On/Off Surnd | Surround On: ○○○○●○○○○○○○○ Surround Off: ○○○○ ○○○○ | Press the Next/Previous button to enable/disable Surround. When enabled (On), the current input will produce surround sound through all 5.1 channels. When disabled (Off), the current source will playback on 3.1 channels (Left, Center, Right, and Sub). |
| DTS TruVolume On/Off TruVol | TruVolume On: ○○○○●○○○○○○○○ TruVolume Off: ○○○○ ○○○○ | Press the Next/Previous button to enable/disable TruVolume. When enabled (On), TruVolume provides a consistent and comfortable volume level for a more enjoyable listening experience. |
| Night Mode On/Off Night | Night Mode On: ○○○○●○○○○○○○○ Night Mode Off: ○○○○ ○○○○ | Press the Next/Previous button to enable/disable Night Mode. When enabled (On), the Sound Bar will lower bass frequency levels to provide a more quiet environment (ideal for apartment living and homes with sleeping children). |
| AV Delay AV Delay | Two LEDs on the left indicate no delay. ●●○○○○○○○○○○ | Press the Next/Previous button to increase/decrease the amount of audio delay. The LED indicators will move to the right with increasing audio delay levels. |
| Noise Noise | — | The Sound Bar, Satellite Speakers, and Subwoofer will emit pink noise to ensure that the system is connected properly. The pink noise will emit in the following sequence: left channel, center channel, right channel, right satellite speaker, left satellite speaker, and subwoofer. |
| TV Remote VZtvRmt On | TV Remote On: ○○○○●○○○○○○○○ TV Remote Off: ○○○○ ○○○○ | Press the Next/Previous button to enable/disable VIZIO TV Remotes. When enabled (On), you can use a VIZIO TV remote control to turn on the Sound Bar (using the TV Volume Up button) and control volume. |
| Eco Power On/Off EcoPwr On | Eco Power On: ○○○○●○○○○○○○○ Eco Power Off: ○○○○ ○○○○ | Press the Next/Previous button to enable/disable Eco Power Mode. When enabled (On), the Sound Bar will go into standby after a period of inactivity. The sound bar will automatically turn off when no audio signal is detected. Off disables this feature. Note: Enable this function if using a TV remote to control the sound bar. |
| Program Remote Prg Remote | — | Press the Next/Previous and Play buttons to toggle and select and program your TV remote to control the Volume Down , Volume Up , and Mute functions on your Sound Bar. See <i>Programming the Sound Bar</i> on page 20. |
| Reset Reset No | — | Press the Next/Previous and Play buttons to select and reset your remote and Sound Bar to the factory default settings. All paired Bluetooth devices will be unpaired. All programmed IR remotes will also be removed. See <i>Resetting to Factory Default Settings</i> on page 21. |
| When a Dolby Digital or DTS signal is detected | Dolby Digital Logo bd DTS Logo dts | Dolby Digital and DTS are only available on either the HDMI , Digital Coaxial Audio In , or Digital Optical Audio In inputs. When a Dolby Digital or DTS signal is detected, the Dolby Digital or DTS logo will light up for 5 seconds before fading away. |

PROGRAMMING THE SOUND BAR

You can program your Sound Bar to accept TV remote IR commands. Press the **MENU** button on the remote, then use the **Up/Down** buttons to navigate to **Prq Remote**. Use the **Next/Previous** buttons to toggle through **Learn Vol -**, **Learn Vol +**, and **Learn Mute**.

| Function | LED Behavior | Description |
|---|---|--|
| Learn Volume Down Learn Vol - | (Waiting to learn) Flash from Left to Right and back continuously. | Press the Play button to put the Sound Bar into learning mode. While the Sound Bar is in learning mode, press the Volume Down button on the TV remote control. All of the LED Indicators on the Sound Bar will flash two times indicating that it has successfully recognized the TV remote. |
| Learn Volume Up Learn Vol + |  | Press the Play button to put the Sound Bar into learning mode. While the Sound Bar is in learning mode, press the Volume Up button on the TV remote control. All of the LED Indicators on the Sound Bar will flash two times indicating that it has successfully recognized the TV remote. |
| Learn Mute Learn Mute | All of the LEDs will blink twice to confirm.  | Press the Play button to put the Sound Bar into learning mode. While the Sound Bar is in learning mode, press the Mute button on the TV remote control. All of the LED Indicators on the Sound Bar will flash two times indicating that it has successfully recognized the TV remote. |

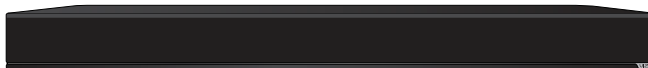

When programming your Sound Bar, turn off your TV speakers.



TV Remote

Ensure that both the Sound Bar and TV remotes are pointed at the front of the Sound Bar.

RESETTING TO FACTORY DEFAULT SETTINGS

You can reset your Sound Bar to factory default settings.

Note: All of your settings will be lost. Paired Bluetooth devices will need to be re-paired.

| Function | LED Behavior | Description |
|--|---|--|
| Reset Reset No ↓ Reset Yes ↓ ConfirmYes ↓ Confirmed | All Indicator LEDs will flash three times confirming factory reset. | To reset the Sound Bar to factory default settings: <ol style="list-style-type: none">1. Press the MENU button on the remote control.2. Use the Up/Down buttons to navigate to Reset No.3. Press the Next button to navigate to Reset Yes and press the Play button.4. ConfirmYes is displayed. Press the Play button to continue.5. Confirmed is displayed. All of the Indicator LEDs on the sound bar will flash three times confirming the reset. |

BLUETOOTH PAIRING

To pair the Sound Bar with a Bluetooth device:

1. Press and hold the **Bluetooth** button  on the Sound Bar for five (5) seconds or select the **BT Pair** option on the remote. When the Sound Bar is in Bluetooth Pairing Mode, the LED Indicators on the Display Panel on the front of the Sound Bar will light sequentially from left to right and back again.
2. You can now search for the Sound Bar (VIZIO S5451w) using your Bluetooth device. For more information, see the documentation that came with your device.
3. Play audio from your Bluetooth device. Volume can be controlled on your source device and the Sound Bar.

Once the device is paired, the LED Indicators will stop flashing.

Back of Sound Bar

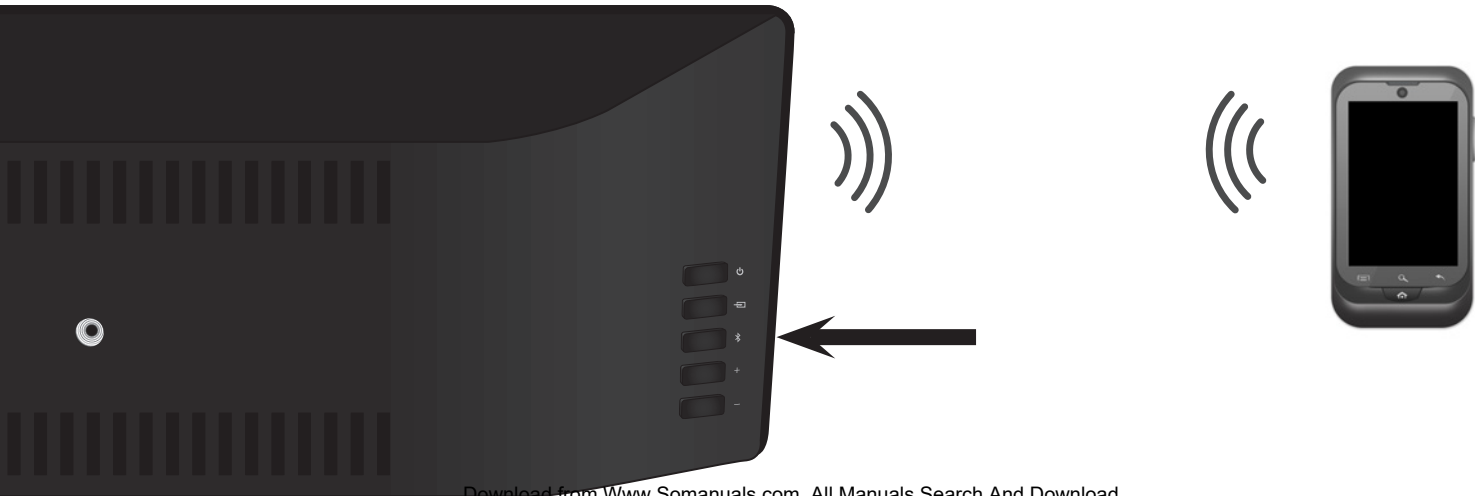

USING BLUETOOTH MODE

Your Sound Bar supports music streaming from smartphones, tablets, and computers with Bluetooth capability. Device compatibility will vary, see your device's documentation for more information.

Once you have paired your source device to the Sound Bar, as long as you stay within range of the Sound Bar, your device should remain paired, even if you change the input on the Sound Bar.

Note: Your Sound Bar is not equipped with a microphone, and therefore cannot operate as a hands-free device for a smartphone.



Did you know?

Your Sound Bar has aptX® built-in, allowing it to deliver the same audio quality as a wired connection, wirelessly over Bluetooth®.*

Maximizing Signal

A Bluetooth signal has a range of up to 30 feet. Keep in mind that Bluetooth is a compressed audio format, so streamed music may lose some integrity when compared to a wired connection.

Try the following if your sound quality is less than optimal:

- If you hear any break-up or disconnect while streaming music from your device, move the source device closer to the Sound Bar.
- Be sure that there are no solid obstructions in the line-of-sight between the Sound Bar and the source device.
- Other wireless devices can affect Bluetooth range, including wireless security cameras, wireless video baby monitors, cordless phones, and microwave ovens. Turning off or moving these devices may improve Bluetooth range.

* Source Bluetooth playback device must be enabled with aptX® technology. Products without aptX® technology will still playback over standard Bluetooth®.

ADVANCED SETUP

Connect up to five different devices to the Sound Bar (devices shown are examples—you can use any device).

Back of Sound Bar

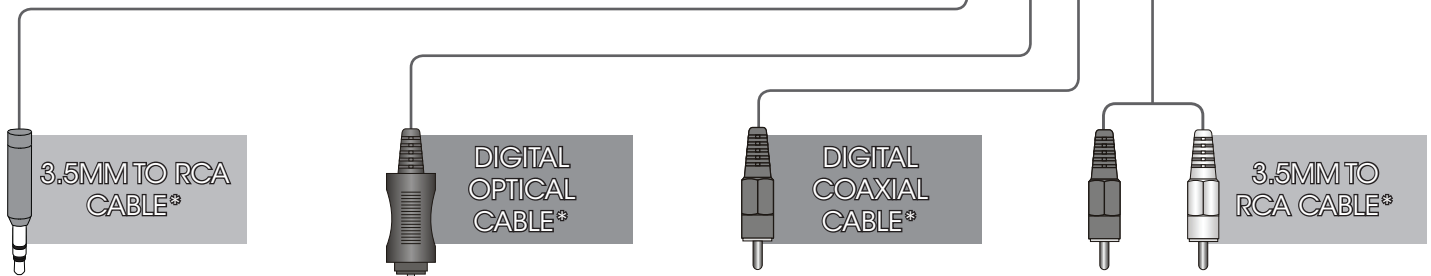

Optical, Coaxial, and 3.5mm cables transmit audio only. If connecting a video device, you will need a separate video connection from the device to your TV.



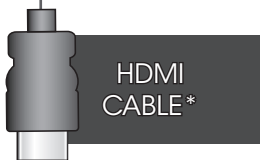
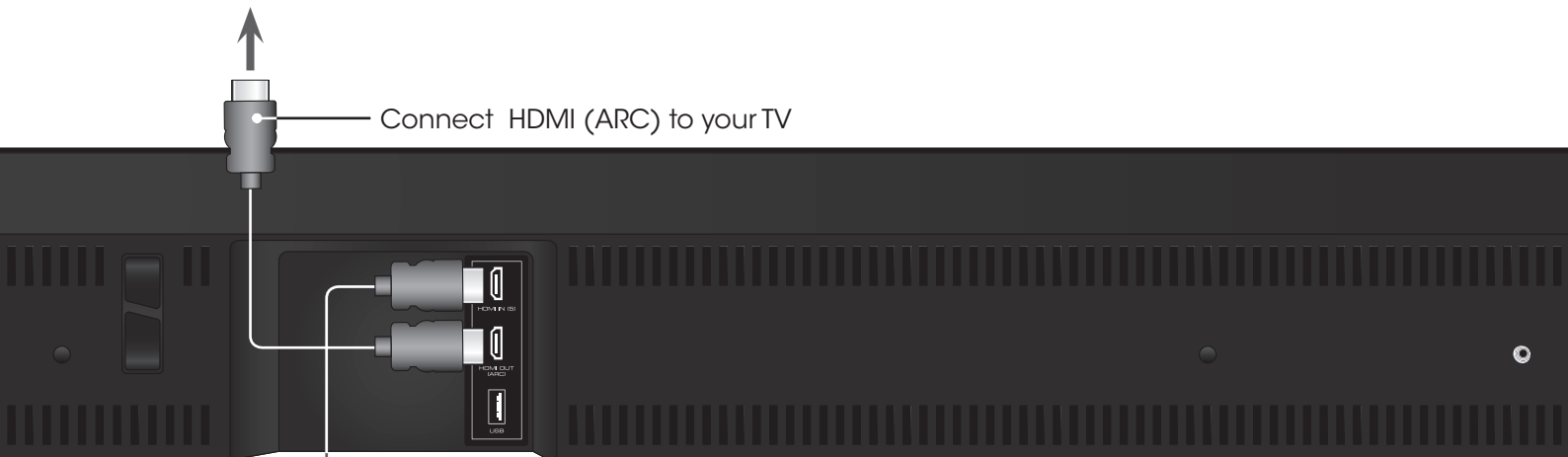

Blu-ray Player

OR



Cable/Satellite Box

HDMI cables transmit both audio and video. To view video from these devices, turn the Sound Bar on, then set the Sound Bar input to **HDMI-ARC 6**. Set your TV input to the HDMI port to which the Sound Bar is connected.

WALL MOUNTING THE SOUND BAR

1

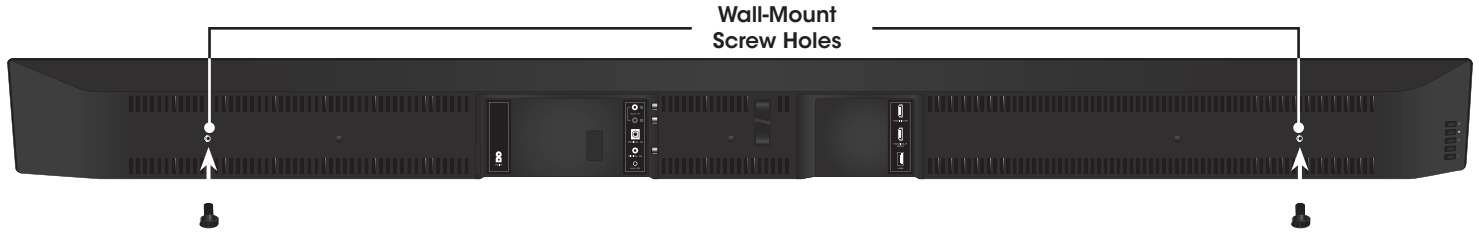

Insert and tighten two Wall-Mount Screws with a Phillips-head screwdriver into the Wall-Mount Screw Holes.

2

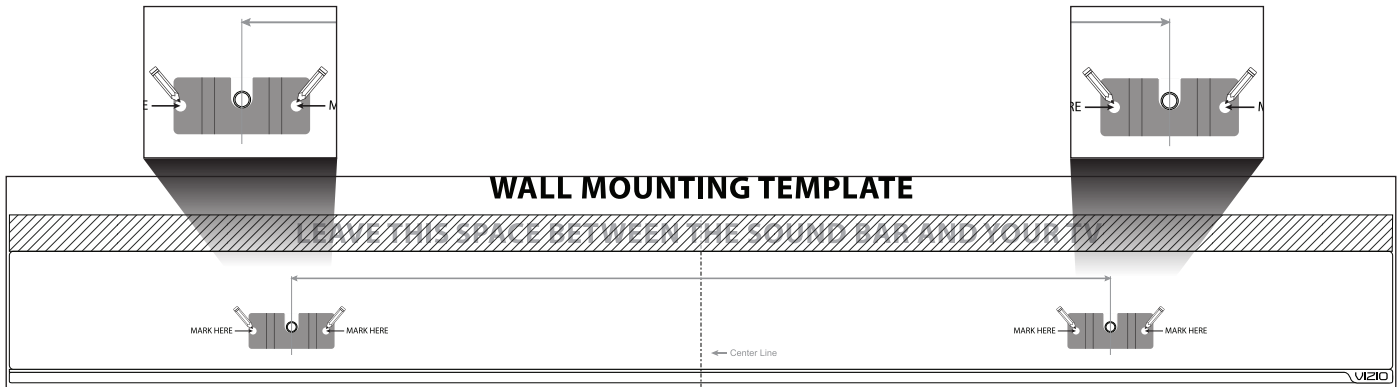

Place the included wall mounting template against the wall under your TV. Mark the four bracket holes using a pencil.

3

Be sure your screws are attached to wood studs or drywall anchors (for drywall) or concrete anchors (for brick/concrete walls). Wall mounting hardware is not included.

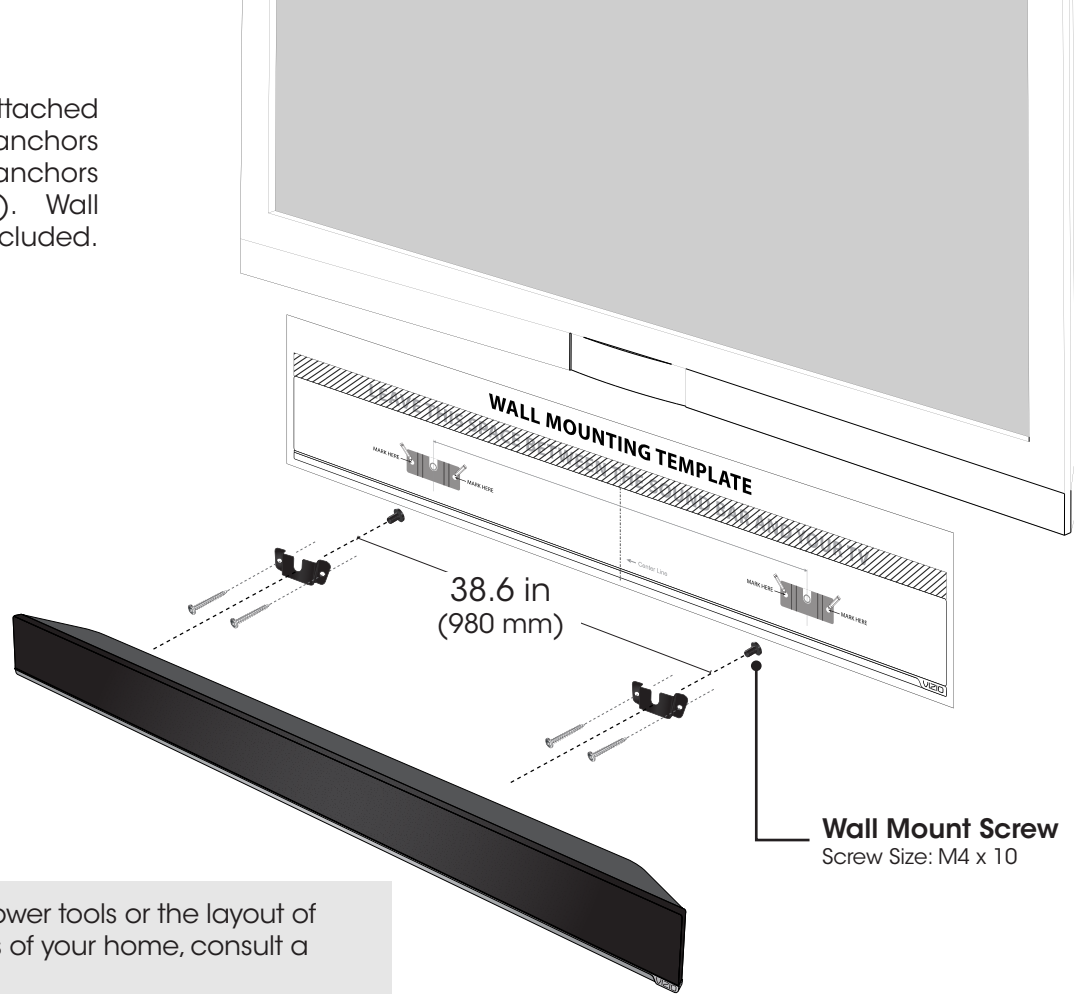

If you are unfamiliar with power tools or the layout of electrical wiring in the walls of your home, consult a professional installer.

RE-LINKING THE SUBWOOFER WITH THE SOUND BAR

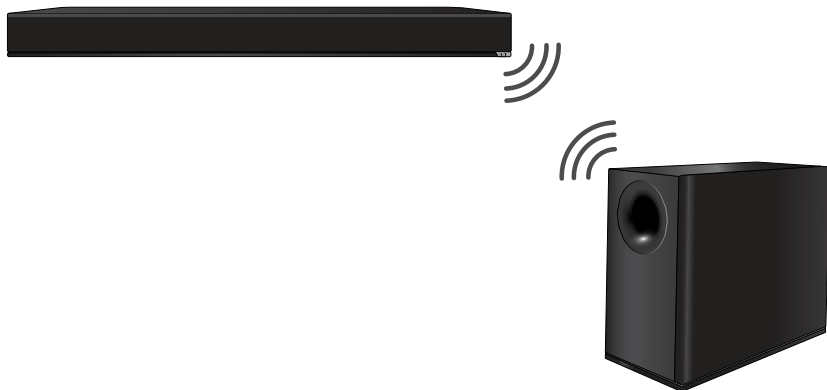

Your Subwoofer has already been paired with your Sound Bar by VIZIO. However, you may need to re-link the Subwoofer to the Sound Bar if there is no sound coming from the Subwoofer.



What does pairing mean?
Pairing means to wirelessly connect.

1



Back of Subwoofer

First confirm that the power switch is in the **ON** position.

Press and hold the **Pairing** button on the back of the Subwoofer for 5 seconds. The LED on the back of the Subwoofer will begin to blink.

2

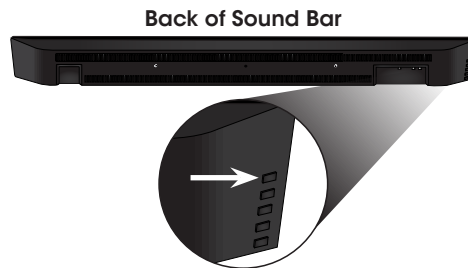

Back of Sound Bar

Press and hold the **Power** button on the back of the Sound Bar for 5 Seconds. The LED indicators on the front will flash 3 times. The Subwoofer is now linked with the Sound Bar.

WALL MOUNTING THE SATELLITE SPEAKERS

1. Attach the Wall Mount Screw to the back of the Satellite Speaker.
2. Attach the wall mount bracket to the wall.
3. Plug the speaker cable into the back of the Satellite Speaker.
4. Align and mount the Satellite Speaker with the Wall Mount Bracket.

Be sure your screws are attached to wood studs or drywall anchors (for drywall) or concrete anchors (for brick/concrete walls). Wall mounting hardware is not included.

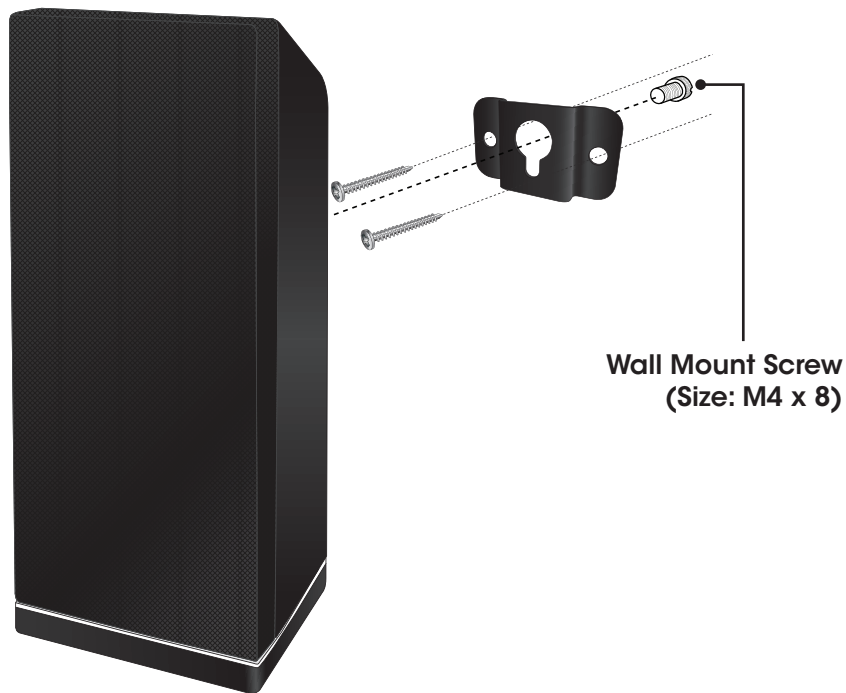

If you are unfamiliar with power tools or the layout of electrical wiring in the walls of your home, consult a professional installer.

Do You Have Questions? Find Answers At

SUPPORT.VIZIO.COM

Find help with:

- New Product Setup
- Connecting Your Devices
- Technical Problems
- Product Updates
- And More



**Live Chat
Support Available**

**You can also contact our
award-winning support team at:**

Phone: (877) 878-4946 (TOLL-FREE)

Email: techsupport@VIZIO.com

Hours Of Operation:

Monday - Friday: 5 AM TO 8 PM (PST)

Saturday - Sunday: 7 AM TO 4 PM (PST)

Download from www.Somanuals.com. All Manuals Search And Download.



HELP & TROUBLESHOOTING

There is no power.

- Press the **POWER** button on the remote control or on the side of your Sound Bar.
 - Ensure the power cord is securely connected.
 - Plug a different device into the electrical outlet to verify that the outlet is working correctly.
-

There is no sound.

- Increase the volume. Press **Volume Up** on the remote control or on the side of your Sound Bar.
 - Press **MUTE** on the remote to ensure the Sound Bar is not muted.
 - Press **INPUT** on the remote or on the side of your Sound Bar to select a different input source.
 - When using either of the Digital Inputs, if there is no audio: (A) Try setting the TV output to PCM or (B) Connect directly to your Blu-ray/other source, some TVs do not pass through digital audio.
 - On digital inputs, the input LEDs will flash rapidly if an unsupported format is present. Set the source to output PCM.
 - Your TV may be set to variable audio output. Confirm that the audio output setting is set to FIXED or STANDARD, not VARIABLE. Consult your TV's user manual for more detailed information.
 - If using Bluetooth, ensure that the volume on your source device is turned up and that the device is not muted.
-

I hear buzzing or humming.

- Ensure all cables and wires are securely connected.
 - Connect a different source device (TV, Blu-ray player, etc) to see if the buzzing persists. If it does not, the problem may be with the original device.
 - Connect your device to a different input on the Sound Bar.
-

The remote isn't working.

- Replace the remote batteries with new ones.
- Point the remote directly at the center of the Sound Bar when pressing a button.
- If using a Bluetooth connection, some of the buttons on the remote may not be supported by the streaming application. (e.g., Pandora doesn't support the Back button.)

ONE-YEAR LIMITED WARRANTY

ON PARTS AND LABOR

Covers units purchased as new in United States and Puerto Rico Only

VIZIO provides a warranty to the original purchaser of a new Product against defects in materials and workmanship for a period of one year of non-commercial usage and ninety (90) days of commercial use. If a Product covered by this warranty is determined to be defective within the warranty period, VIZIO will either repair or replace the Product at its sole option and discretion.

To obtain warranty service, contact VIZIO Technical Support via email: TechSupport@VIZIO.com or via phone at 877 MY VIZIO (877.698.4946) from 5:00AM to 8:00PM Monday through Friday and 7:00AM to 4:00PM Saturday and Sunday, Pacific Time, or visit www.VIZIO.com. PRE-AUTHORIZATION MUST BE OBTAINED BEFORE SENDING ANY PRODUCT TO A VIZIO SERVICE CENTER. Proof of purchase in the form of a purchase receipt or copy thereof is required to show that a Product is within the warranty period.

Parts and Labor

There will be no charge for parts or labor during the warranty period. Replacement parts and Products may be new or recertified at VIZIO's option and sole discretion. Replacement parts and Products are warranted for the remaining portion of the original warranty or for ninety (90) days from warranty service or replacement, whichever is greater.

Type of Service

Defective Products must be sent to a VIZIO service center to obtain warranty service. VIZIO is not responsible for transportation costs to the service center, but VIZIO will cover return shipping to the customer. PRE-AUTHORIZATION IS REQUIRED BEFORE SENDING ANY PRODUCT TO A VIZIO SERVICE CENTER FOR WARRANTY SERVICE.

Product returns to VIZIO's service centers must utilize either the original carton box and shipping material or packaging that affords an equal degree of protection. VIZIO Technical Support will provide instructions for packing and shipping the covered Product to the VIZIO service center.

Limitations and Exclusions

VIZIO's one-year limited warranty only covers defects in materials and workmanship. This warranty does not cover, for example: cosmetic damage, normal wear and tear, improper operation, improper voltage supply or power surges, signal issues, damages from shipping, acts of God, any type of customer misuse, modifications or adjustments, as well as installation and set-up issues or any repairs attempted by anyone other than by a VIZIO authorized service center. Products with unreadable or removed serial numbers, or requiring routine maintenance are not covered. This one year limited warranty does not cover Products sold "AS IS", "FACTORY RECERTIFIED", or by a non-authorized reseller.

THERE ARE NO EXPRESS WARRANTIES OTHER THAN THOSE LISTED OR DESCRIBED ABOVE. ANY IMPLIED WARRANTIES, INCLUDING ANY IMPLIED WARRANTY OF MERCHANTABILITY AND FITNESS FOR A PARTICULAR PURPOSE, SHALL BE LIMITED IN DURATION TO THE PERIOD OF TIME SET FORTH ABOVE. VIZIO'S TOTAL LIABILITY FOR ANY AND ALL LOSSES AND DAMAGES RESULTING FROM ANY CAUSE WHATSOEVER INCLUDING VIZIO'S NEGLIGENCE, ALLEGED DAMAGE, OR DEFECTIVE GOODS, WHETHER SUCH DEFECTS ARE DISCOVERABLE OR LATENT, SHALL IN NO EVENT EXCEED THE PURCHASE PRICE OF THE PRODUCT. VIZIO SHALL NOT BE RESPONSIBLE FOR LOSS OF USE, LOSS OF INFORMATION OR DATA, COMMERCIAL LOSS, LOST REVENUE OR LOST PROFITS, OR OTHER INCIDENTAL OR CONSEQUENTIAL DAMAGES. SOME STATES DO NOT ALLOW LIMITATIONS ON HOW LONG AN IMPLIED WARRANTY LASTS OR THE EXCLUSION OF INCIDENTAL OR CONSEQUENTIAL DAMAGES, SO THE ABOVE LIMITATIONS OR EXCLUSIONS MAY NOT APPLY TO YOU. THIS WARRANTY GIVES YOU SPECIFIC LEGAL RIGHTS, AND YOU MAY ALSO HAVE OTHER RIGHTS, WHICH VARY FROM STATE TO STATE. THIS WARRANTY IS SUBJECT TO CHANGE WITHOUT NOTICE. CHECK www.VIZIO.com FOR THE MOST CURRENT VERSION.

SPECIFICATIONS

Sound Bar: Two 3" High-Efficiency Full-Range Transducers (Left and Right)
One 3" High-Efficiency Full-Range Transducer (Center)
Two 3" x 6" Bass Radiators

Satellite: One 3" High-Efficiency Full-Range Transducer (Each Satellite)

Inputs: One 3.5mm Stereo Audio
One RCA Stereo Audio
One Optical (Toslink)
One Digital Coaxial Audio
One HDMI (ARC on output HDMI)
One USB (Supports .WAV format only)
Bluetooth (Wireless)

Sound Pressure Level (System): 104 dB

Frequency Response (System): 45 Hz - 20 KHz

Voltage: 120 VAC, 60 Hz

Compliances: UL, C-UL, FCC

LEGAL & COMPLIANCE

FCC Class B Radio Interference Statement

NOTE: This equipment has been tested and found to comply with the limits for a Class B digital device, pursuant to Part 15 of the FCC Rules. These limits are designed to provide reasonable protection against harmful interference in a residential installation. This equipment generates, uses and can radiate radio frequency energy, and if not installed and used in accordance with the instructions, may cause harmful interference to radio communications. However, there is no guarantee that interference will not occur in a particular installation. If this equipment does cause harmful interference to radio or television reception, which can be determined by turning the equipment off and on, the user is encouraged to try to correct the interference by one or more of the following measures:

1. Reorient or relocate the receiving antenna.
2. Increase the separation between the equipment and receiver.
3. Connect the equipment into an outlet on a circuit different from that to which the receiver is connected.
4. Consult the dealer or an experienced radio/TV technician for help.

This device complies with Part 15 of the FCC Rules. Operation is subject to the following two conditions: (1) this device may not cause harmful interference, and (2) this device must accept any interference received, including interference that may cause undesired operation.

Notice:

1. The changes or modifications not expressly approved by the party responsible for compliance could void the user's authority to operate the equipment.
2. Shielded interface cables and AC power cord, if any, must be used in order to comply with the emission limits.
3. The manufacturer is not responsible for any radio or TV interference caused by unauthorized modification to this equipment. It is the responsibilities of the user to correct such interference.

RF Exposure Information

This device meets the government's requirements for exposure to radio waves. This device is designed and manufactured not to exceed the emission limits for exposure to radio frequency (RF) energy set by the Federal Communications Commission of the U.S. Government. This device complies with FCC radiation exposure limits set forth for an uncontrolled environment.

IC Statement

Operation is subject to the following two conditions:

1. This device may not cause interference, and
2. This device must accept any interference, including interference that may cause undesired operation of the device.

IC Radiation Exposure Statement

This equipment complies with IC RSS-102 radiation exposure limits set forth for an uncontrolled environment. This equipment should be installed and operated with minimum distance 20cm between the radiator & your body.

Disposal and Recycling

You must dispose of this product properly, according to local laws and regulations. Because this product contains electronic components and a battery, it must be disposed of separately from household waste. Contact local authorities to learn about disposal and recycling options.

Other:

Image(s) used under license from Shutterstock.com



Manufactured under license from Dolby Laboratories. Dolby and the double-D symbol are trademarks of Dolby Laboratories.



For DTS patents, see <http://patents.dts.com>. Manufactured under license from DTS Licensing Limited. DTS, the Symbol, & DTS and the Symbol together are registered trademarks, and DTS Digital Surround is a trademark of DTS, Inc. © DTS, Inc. All Rights Reserved.



For DTS patents, see <http://patents.dts.com>. Manufactured under license from DTS Licensing Limited. DTS, the Symbol, & DTS and the Symbol together are registered trademarks, and DTS TruVolume is a trademark of DTS, Inc. © DTS, Inc. All Rights Reserved.



© 2014 CSR plc and its group companies. The aptX® mark and the aptX logo are trade marks of CSR plc or one of its group companies and may be registered in one or more jurisdictions.



This product qualifies for ENERGY STAR in the "factory default" setting and this is the setting in which power savings will be achieved. Changing the factory default settings or enabling other features will increase power consumption that could exceed the limits necessary to qualify for ENERGY STAR rating.

We want to help you save energy.

Free Manuals Download Website

<http://myh66.com>

<http://usermanuals.us>

<http://www.somanuals.com>

<http://www.4manuals.cc>

<http://www.manual-lib.com>

<http://www.404manual.com>

<http://www.luxmanual.com>

<http://aubethermostatmanual.com>

Golf course search by state

<http://golfingnear.com>

Email search by domain

<http://emailbydomain.com>

Auto manuals search

<http://auto.somanuals.com>

TV manuals search

<http://tv.somanuals.com>