



**WHITE-RODGERS**

**1F81-71**

Programmable Electronic  
Digital Automatic Changeover Multi-stage Thermostat  
**INSTALLATION AND  
OPERATION INSTRUCTIONS**

**Operator: Save these instructions for future use!**

**FAILURE TO READ AND FOLLOW ALL INSTRUCTIONS CAREFULLY  
BEFORE INSTALLING OR OPERATING THIS CONTROL COULD CAUSE  
PERSONAL INJURY AND/OR PROPERTY DAMAGE.**

## DESCRIPTION

Your new White-Rodgers 5-Day/2-Day Digital Multi-stage Thermostat uses the technology of a solid-state microcomputer to provide precise time/temperature control. This thermostat offers you the flexibility to design heating and cooling programs that fit your needs.

### Features:

- Separate 5-day (weekday) and 2-day (weekend) programming with four separate time/temperature periods per program
- Simultaneous heat and cool program storage
- Optional **C** terminal (dual power option)
- Optional Energy Management Recovery (EMR)
- Optional **B** and **O** terminals
- Preprogrammed temperature control
- LCD continuously displays set point, and alternately displays time and room temperature
- Temperature override until next program period
- Manual program override (HOLD temperature)
- °F/°C convertibility
- Temperature range 45° to 90°F
- Two-stage heat/two-stage cool
- Armchair programming capability

## PRECAUTIONS

This thermostat is intended for use with a 24-volt system; do not use this thermostat with a millivolt or line voltage system. If in doubt about whether your wiring is millivolt, line, or low voltage, have it inspected by a qualified heating and air conditioning contractor or electrician.

Do not exceed the specification ratings.

All wiring must conform to local and national electrical codes and ordinances.

This control is a precision instrument, and should be handled carefully. Rough handling or distorting components could cause the control to malfunction.

### **⚠ CAUTION**

**To prevent electrical shock and/or equipment damage disconnect electric power to system at main fuse or circuit breaker box until installation is complete.**

### **⚠ WARNING**

**Do not use on circuits exceeding specified voltage. Higher voltage will damage control and could cause shock or fire hazard.**

**Do not short out terminals on gas valve or primary control to test. Short or incorrect wiring will damage thermostat and could cause personal injury and/or property damage.**

## SPECIFICATIONS

### ELECTRICAL DATA

#### Electrical Rating:

- 20 to 30 VAC 50/60 Hz. or D.C.
- 0.05 to 1.5 Amps (Load per terminal)
- 2.5 Amps Maximum Total Load** (All terminals combined)

### THERMAL DATA

#### Setpoint Temperature Range:

45°F to 90°F (7°C to 32°C)

#### Operating Ambient Temperature Range:

32°F to 105°F

#### Operating Humidity Range:

0 to 90% RH (non-condensing)

#### Shipping Temperature Range:

-40°F to 150°F

### APPLICATIONS

For use with:

- Heat/cool systems with up to two stages heat, two stages cool

#### DO NOT USE WITH:

- Millivolt systems
- Systems exceeding 30 VAC and 2.5 amps
- 3-wire zoned hydronic heating systems



**WHITE-RODGERS DIVISION**

EMERSON ELECTRIC CO.

9797 REAVIS ROAD

ST. LOUIS, MISSOURI 63123-5398

Printed in U.S.A.

**PART NO. 37-5938B**

Replaces 37-5938A

9912

# INSTALLATION

## REMOVE OLD THERMOSTAT

1. Shut off electricity at the main fuse box until installation is complete. Ensure that electrical power is disconnected.
2. Remove the front cover of the old thermostat. **With wires still attached**, remove wall plate from the wall. If the old thermostat has a wall mounting plate, remove the thermostat and the wall mounting plate as an assembly.
3. **Identify each wire attached to the old thermostat using the labels enclosed with the new thermostat.**
4. Disconnect the wires from old thermostat one at a time. **DO NOT LET WIRES FALL BACK INTO THE WALL.**
5. Install new thermostat using the following procedures.

## PRE-INSTALLATION SET-UP

1. Remove the packing material from the thermostat.
2. This thermostat is configured from the factory to operate a heat/cool, fossil fuel (gas, oil, etc.), forced air system with up to 2 stages of heat and 2 stages of cool. It is configured correctly for any system that DOES NOT require the thermostat to energize the fan on a call for heat.

If your system is an electric heat or heat-pump system that **REQUIRES** the thermostat to turn on the fan on a call for heat, locate the **GAS/ELECTRIC switch** on the back of the thermostat (see fig. 1) and switch it to the **ELECTRIC** position. This will allow the thermostat to energize the fan immediately on a call for heat. If you are unsure if the heating/cooling system requires the thermostat to control the fan, contact a qualified heating and air conditioning service person.

3. Two jumpers are also located on the back of the thermostat, so that you may customize the thermostat to meet your individual preference (see fig. 1). In most applications, the factory jumper settings provide the most comfortable and convenient thermostat operation.

Jumper wire **W905** determines how fast the system cycles on and off, based on temperature change. As shipped from the factory, the thermostat will maintain a very consistent room temperature, usually within 1°F of the thermostat setting. To achieve a slower on and off cycle, providing a slightly wider temperature span, cut and separate jumper wire **W905**.

Jumper wire **W903** controls the Energy Management Recovery (EMR) feature. EMR allows the thermostat to energize the heating system up to 30 minutes *before* the time programmed into the thermostat. The thermostat will then energize the system to gradually raise the temperature to your programmed temperature by using the most efficient stage of heat practical.

For example, assume that the thermostat is programmed overnight to 66°F and the room temperature is 66°. If the next program is 7 AM, 70°F (an increase of 4°), the thermostat will start the system 30 minutes before 7 AM. If the temperature in the room is within 2°F of your next programmed temperature, the thermostat will not start the system early.

**DO NOT** clip jumper wire **W903** unless you wish to permanently disable the EMR feature.

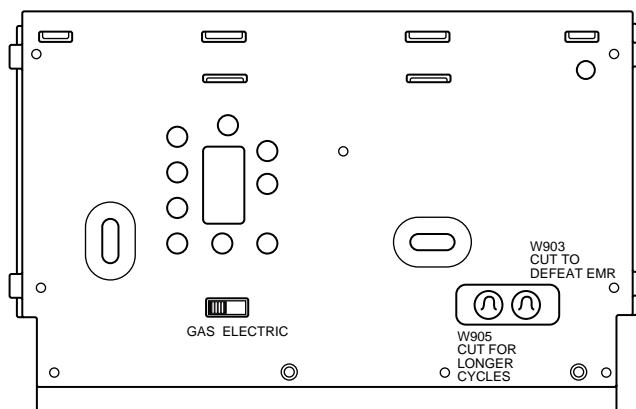

Figure 1. Back of thermostat base

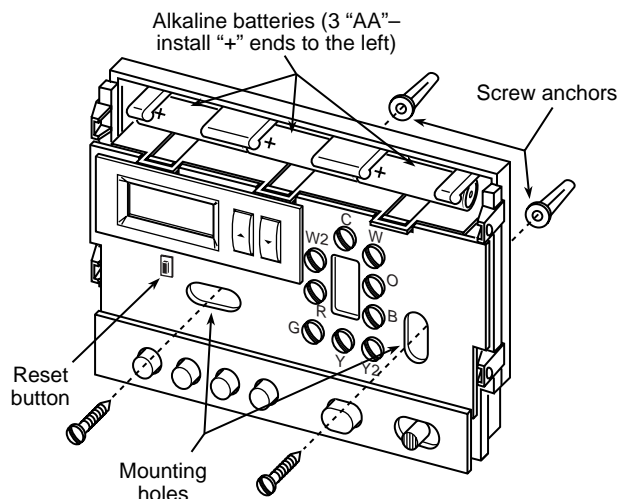

Figure 2. Thermostat base

## INSTALLING THE THERMOSTAT

1. Gently remove the cover by pulling it straight off the base. Forcing or prying on the unit may cause damage to the unit.
2. Remove the battery tab. With the batteries installed, the Armchair Programming feature allows you to program the thermostat before installing it on the wall.
3. Pull wires through the hole in the thermostat base and place the base over the hole in the wall. Mark mounting hole locations on the wall using the base as a template.
4. Move the base out of the way. Drill mounting holes.
5. Fasten the base loosely to the wall, as shown in fig. 2, using two mounting screws. Place a level against the bottom of the base, adjust until level, and then tighten the screws. (Leveling is for appearance only and will not affect thermostat operation.) If you are using existing mounting holes, or if the holes drilled are too large and do not allow you to tighten the base snugly, use plastic screw anchors to secure the base.
6. Check that the system is turned off. Connect the wires beneath the terminal screws on the base using the appropriate wiring diagram (see figs. 3 through 5).
7. Push excess wire into wall and plug hole with a fire-resistant material (such as fiberglass insulation) to prevent drafts from affecting thermostat operation.

(Instructions continue on page 4.)

**NOTE**

The following wiring diagrams show **typical** terminal identification and wiring. For proper installation, refer to the original manufacturer's instructions.

**NOTE**

Relay contacts shown are thermostatically operated.

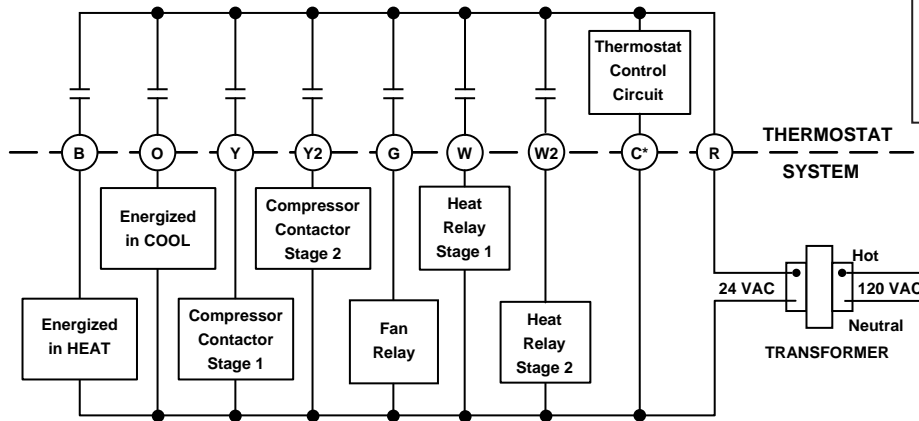

\* The 24 Volt neutral connection to terminal **C** on the thermostat is not required if you replace the batteries once a year with fresh "AA" Energizer® alkaline batteries.

Figure 3. Typical wiring diagram for single transformer systems

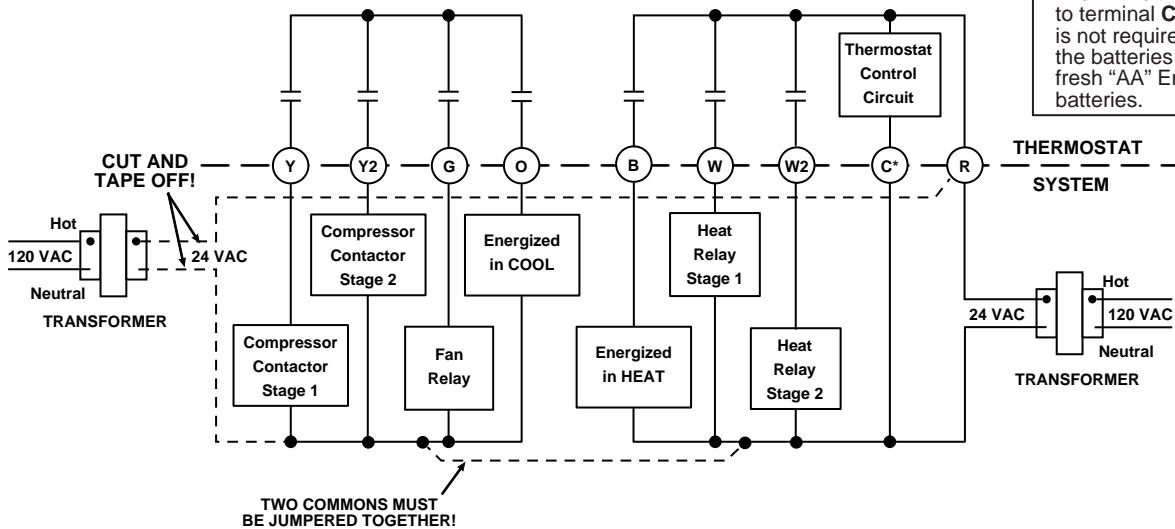

\* The 24 Volt neutral connection to terminal **C** on the thermostat is not required if you replace the batteries once a year with fresh "AA" Energizer® alkaline batteries.

Figure 4. Typical wiring diagram for two-transformer systems with NO safety circuits

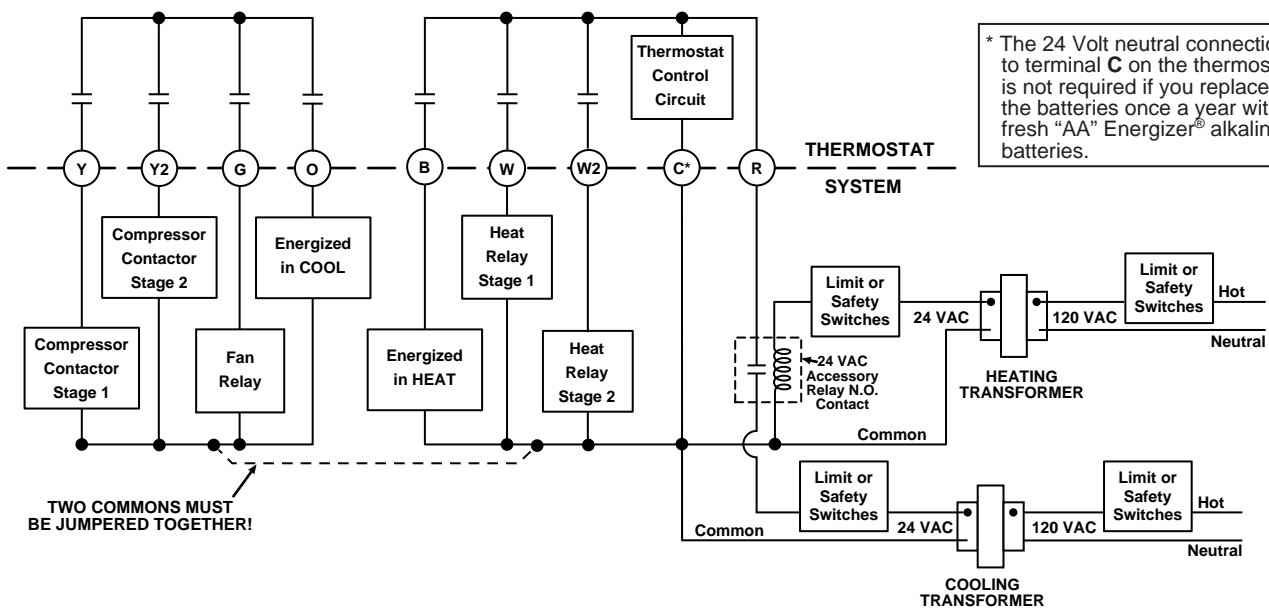

\* The 24 Volt neutral connection to terminal **C** on the thermostat is not required if you replace the batteries once a year with fresh "AA" Energizer® alkaline batteries.

Figure 5. Typical wiring diagram for two-transformer systems with safety circuits in BOTH systems

## CHECK THERMOSTAT OPERATION



### NOTE

If at any time during testing, your system does not operate properly, contact a qualified serviceperson.

### Fan Operation

1. Turn on power to the system.
2. Press SYSTEM button until the system is **OFF**.
3. Move FAN switch to **ON**. The blower should begin to operate.
4. Move FAN switch to **AUTO** position. The blower should stop within a short period of time.

### Heating System

1. Press SYSTEM button to turn thermostat to **HEAT**.
2. Press  to adjust thermostat setting to 90° and **hold for five seconds**. After you release the button, both stages of the heating system should begin to operate within five seconds.
3. Press  to adjust temperature setting below room temperature. The auxiliary heating system will stop immediately and the first stage will stop within three to four minutes.

### Cooling System

#### CAUTION

To prevent compressor and/or property damage, if the outdoor temperature is below 50°F, DO NOT operate the cooling system.

1. Press SYSTEM button to turn thermostat to **COOL**.
2. Press  to adjust thermostat setting to 45° and **hold for five seconds**. After you release the button, the blower should come on immediately on high speed, followed by cold air circulation. Both stages of the cooling system should begin to operate (if you have a two-stage cooling system).

If the fan is running but the compressor is not running and the word **COOL** is flashing, the compressor lockout feature is operating (see **Lockout Bypass Option** to temporarily override the compressor lockout feature during testing).

3. Press  to adjust temperature setting above room temperature. The cooling system should stop operating.



### NOTE

During normal operation, the second stage of heat or cool may take 15 to 30 minutes to turn on. The delay varies depending on the performance of the first stage. Typically the second stage will come on sooner in more severe weather, while in milder weather it will take longer. There is no adjustment to this feature, as it is designed to maximize both comfort and efficiency.

### LOCKOUT BYPASS OPTION

**FOR QUALIFIED SERVICE TECHNICIANS' USE ONLY. OPERATORS SHOULD NOT USE THIS FEATURE DUE TO POSSIBILITY OF EQUIPMENT OR PROPERTY DAMAGE, OR PERSONAL INJURY.**



### COMPRESSOR SHORT TERM CYCLE PROTECTION

This thermostat has a built-in short term (5-minute) time delay. During this 5-minute period, the thermostat will lock out the compressor to allow head pressure to stabilize. If you want to override this feature while testing thermostat operation, simply press  and  buttons at the same time.

**DO NOT USE THE LOCKOUT BYPASS OPTION UNLESS THE COMPRESSOR OIL HEATERS HAVE BEEN OPERATIONAL FOR 6 HOURS AND THE SYSTEM HAS NOT BEEN OPERATIONAL FOR AT LEAST 5 MINUTES.**

Before you begin programming your thermostat, you should be familiar with its features and with the display and the location and operation of the thermostat buttons. Your thermostat consists of two parts: the **thermostat cover** and the **base**. To remove the cover, gently pull it straight out from the base. To replace the cover, line up the cover with the base and press gently until the cover snaps onto the base.

## THE THERMOSTAT BASE

Other than  and , the following buttons and switches are located behind the door on the bottom of the thermostat cover (see fig. 6). Pull the door down to open it.

### The Thermostat Buttons and Switches

- ① (Red arrow) Raises temperature setting.
- ② (Blue arrow) Lowers temperature setting.
- ③ SET TIME button.
- ④ VIEW PRGM (program) button.
- ⑤ RUN PRGM (program) button.
- ⑥ HOLD TEMPerature button.
- ⑦ SYSTEM button (COOL, OFF, HEAT, AUTO).
- ⑧ FAN switch (ON, AUTO).

### The Display

- ⑨ Indicates day of the week.
- ⑩ **HEAT** is displayed when the SYSTEM button has been pressed to put the thermostat in the HEAT mode. **COOL** is displayed when the SYSTEM button has been pressed to put the thermostat in the COOL mode. **COOL** is displayed (flashing) when the compressor is in lockout mode. **AUTO** is displayed when the SYSTEM button has been pressed to put the thermostat in the automatic changeover (AUTO) mode. **1+2** indicates the number of stages the thermostat is calling for.
- ⑪ Alternately displays current time and temperature.
- ⑫ The word **HOLD** is displayed when the thermostat is in the HOLD mode.
- ⑬ **BATT** is displayed when approximately 70% of battery life has been exhausted.
- ⑭ Displays currently programmed set temperature (this is blank when SYSTEM button has been pressed to turn the system OFF).
- ⑮ **LK** is displayed when keypad lockout has been activated.

## OPERATING FEATURES

Now that you are familiar with the thermostat buttons and display, read the following information to learn about the many features of the thermostat.

- **SIMULTANEOUS HEATING/COOLING PROGRAM STORAGE**—When programming, you can enter both your heating and cooling programs at the same time. There is no need to reprogram the thermostat at the beginning of each season.

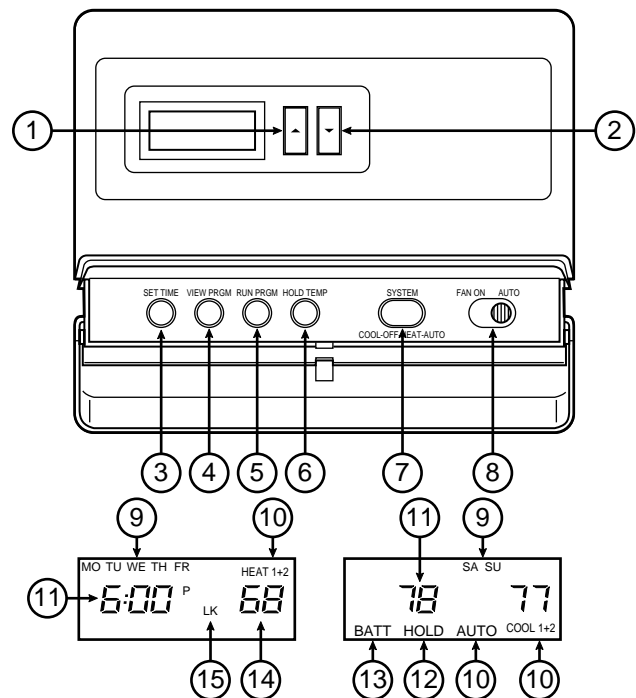







Figure 6. Thermostat display, buttons, and switches

- **AUTOMATIC CHANGEOVER** —If you have a heating/cooling system, you can set the thermostat to automatically switch from heat to cool as needed to maintain setpoint temperature. To select this mode, press SYSTEM button until **AUTO** is displayed along with **HEAT** or **COOL**, identifying the program automatically selected.
- In **AUTO** mode, pressing  and  at the same time will change the displayed setpoint temperature to the setpoint of the other mode (**HEAT** or **COOL**). This allows you to change both the **HEAT** and **COOL** setpoints, if desired.
- **TOTAL KEYPAD LOCKOUT** — This security feature allows you to lock out the thermostat buttons and switches to prevent unauthorized tampering. To select this feature after programming, press SET TIME and RUN PRGM buttons at the same time **and hold** until **LK** is displayed. To unlock the thermostat, press SET TIME and RUN PRGM buttons at the same time until **LK** is no longer displayed.
- **TEMPERATURE OVERRIDE** — Press  or  until the display shows the temperature you want. The thermostat will override current programming and keep the room temperature at the selected temperature until the next program period begins. Then the thermostat will automatically revert to the program.
- **HOLD TEMPERATURE** — The thermostat can hold any temperature within its range for an indefinite period, without reverting to the programmed temperature. Press the HOLD TEMP button. **HOLD** will be displayed. Then choose the desired hold temperature by pressing  or . The thermostat will hold the room temperature at the selected setting until you press RUN PRGM button to start program operation again.
- **°F/°C CONVERTIBILITY** — Press SET TIME and HOLD TEMP buttons until the temperature display is in Celsius. To display Fahrenheit, repeat the process.

(Instructions continue on page 6.)

- **TEMPERATURE DISPLAY ADJUSTMENT** — Your new thermostat has been accurately set in our factory. However, if you wish, you may adjust your new thermostat temperature display to match your old thermostat. This can be accomplished (within a  $\pm 4^{\circ}\text{F}$  range) as follows:

1. Press VIEW PRGM and HOLD TEMP buttons at the same time.
2. Press  $\uparrow$  or  $\downarrow$  to adjust the displayed temperature to your desired setting.
3. Press RUN PRGM to resume normal program operation.

## PROGRAMMING YOUR THERMOSTAT

Now you are ready to program your thermostat. This section will help you plan your thermostat's program to meet your needs. For maximum comfort and efficiency, keep the following guidelines in mind when planning your program.

- When heating (cooling) your building, program the temperatures to be cooler (warmer) when the building is vacant or during periods of low activity.
- During early morning hours, the need for cooling is usually minimal.

Look at the factory preprogrammed times and temperatures shown below. If this program will suit your needs, simply press the RUN PRGM button to begin running the factory preset program.

FACTORY PREPROGRAMMING					
Heating Program for ALL days of the Week:			Cooling Program for ALL Days of the Week:		
PERIOD	TIME	TEMP	PERIOD	TIME	TEMP
1st	6:00 AM	70°F	1st	6:00 AM	78°F
2nd	8:00 AM	62°F	2nd	8:00 AM	85°F
3rd	5:00 PM	70°F	3rd	5:00 PM	78°F
4th	10:00 PM	62°F	4th	10:00 PM	82°F

If you want to change the preprogrammed times and temperatures, follow these steps.

Determine the time periods and heating and cooling temperatures for your weekday and weekend programs. You must program four periods for both the weekday and weekend program. However, you may use the same heating and cooling temperatures for consecutive time periods. You can choose start times, heating temperatures, and cooling temperatures independently for both weekday and weekend programs (for example, you may select 5:00 AM and 70° as the weekday **1st period heating** start time and temperature, and also choose 7:00 AM and 76° as the weekday **1st period cooling** start time and temperature).

Heating/Cooling Schedule Plan

Period	WEEKDAY (5 DAY)		WEEKEND (2 DAY)	
	Start Time	Temperature	Start Time	Temperature
1ST HEAT				
2ND HEAT				
3RD HEAT				
4TH HEAT				
1ST COOL				
2ND COOL				
3RD COOL				
4TH COOL				

Use the table at the bottom of the page to plan your program time periods, and the temperatures you want during each period. You may also want to look at the sample program table to get an idea of how the thermostat can be programmed.

## Entering Your Program

Follow these steps to enter the heating and cooling programs you have selected.

### Set Current Time and Day

1. Press SET TIME button once. The display will show the hour only.

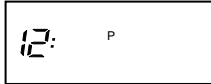
EXAMPLE: 

2. Press and hold either  $\uparrow$  or  $\downarrow$  until you reach the correct hour (the letter **P** should be displayed for **PM** time, which begins at noon).
3. Press SET TIME once. The display window will show the minutes only.

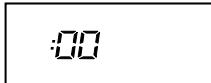
EXAMPLE: 

4. Press and hold either  $\uparrow$  or  $\downarrow$  until you reach the correct minutes.
5. Press SET TIME once. The display will show the day of the week.
6. Press  $\uparrow$  or  $\downarrow$  until you reach the current day of the week.
7. Press RUN PRGM once. The display will show the correct time and room temperature alternately.

### Enter Heating Program



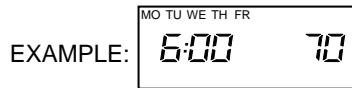

1. If you want to change the display from Fahrenheit to Celsius (or vice-versa), press SET TIME and HOLD TEMP at the same time.
2. Press the SYSTEM button until **HEAT** is displayed.
3. Press VIEW PRGM once. "**MO TU WE TH FR**" (indicating weekday program) will be displayed. Also displayed are the currently programmed start time for the **1st heating** period and the currently programmed temperature (flashing).

SAMPLE Heating/Cooling Schedule Plan

Period	WEEKDAY (5 DAY)		WEEKEND (2 DAY)	
	Start Time	Temperature	Start Time	Temperature
1ST HEAT	5:30 AM	68°F	7:00 AM	68°F
2ND HEAT	8:00 AM	65°F	11:00 AM	70°F
3RD HEAT	5:00 PM	70°F	6:00 PM	70°F
4TH HEAT	10:30 PM	65°F	11:30 PM	65°F
1ST COOL	6:30 AM	76°F	7:00 AM	76°F
2ND COOL	2:00 PM	78°F	12:30 PM	74°F
3RD COOL	5:00 PM	72°F	6:00 PM	72°F
4TH COOL	10:30 PM	78°F	11:30 PM	78°F



This display window shows that for the 1st weekday period, the start time is 6:00 AM, and 70° is the programmed temperature (this example reflects factory preprogramming).

4. Press  or  to change the displayed temperature to your selected temperature for the 1st heating program period.
5. Press SET TIME once (the programmed time will flash). Press  or  until your selected time is displayed. The time will change in 15 minute increments. When your selected time is displayed, press SET TIME again to return to the change temperature mode.
6. Press VIEW PRGM once. The currently programmed start time and setpoint temperature for the **2nd heating** program period will be displayed.
7. Repeat steps 4 and 5 to select the start time and heating temperature for the 2nd heating program period.
8. Repeat steps 4 through 6 for the 3rd and 4th heating program periods. Weekday heating programs are now complete.
9. Press VIEW PRGM once. "SA SU" (indicating weekend program) will be displayed, along with the start time for the 1st heating period and the currently programmed temperature.
10. Repeat steps 4 through 8 to complete weekend heating programming.
11. When you have completed entering your heating program, press RUN PRGM.

### Enter Cooling Program

#### CAUTION

**If the outside temperature is below 50°F, disconnect power to the cooling system before programming. Energizing the air conditioner compressor during cold weather may cause personal injury or property damage.**

1. Press SYSTEM button until **COOL** is displayed.
2. Follow the procedure for entering your heating program, using your selected cooling times and temperatures.

## CHECK YOUR PROGRAMMING

Follow these steps to check your thermostat programming one final time before beginning thermostat operation.

1. Press SYSTEM button until **HEAT** is displayed.
2. Press VIEW PRGM to view the 1st weekday heating period time and temperature. Each time you press VIEW PRGM, the next heating period time and temperature will be displayed in sequence for weekday, then weekend program periods (you may change any time or temperature during this procedure).
3. Press RUN PRGM.
4. Press SYSTEM button until **COOL** is displayed.
5. Repeat step 2 to check cooling temperatures.
6. Press RUN PRGM to begin program operation.
7. Press SYSTEM button to select **HEAT**, **COOL**, or **AUTO** mode.

**YOUR THERMOSTAT IS NOW COMPLETELY PROGRAMMED AND READY TO AUTOMATICALLY PROVIDE MAXIMUM COMFORT AND EFFICIENCY!**

#### NOTE

During normal operation, the second stage of heat or cool may take 15 to 30 minutes to turn on. The delay varies depending on the performance of the first stage. Typically the second stage will come on sooner in more severe weather, while in milder weather it will take longer. There is no adjustment to this feature, as it is designed to maximize both comfort and efficiency.

## TROUBLESHOOTING

If your thermostat's display is frozen or displaying incorrectly, the thermostat may have been affected by static discharge or voltage variations. If this happens, press the RESET button (see fig. 2, page 2 for the location of the button). Pressing the RESET button will clear all user programming. The thermostat will revert to factory preprogramming. You will need to reset the time and, if desired, reprogram the thermostat to your selected program. If pressing the RESET button does not correct the problem, contact a qualified service technician.

For optimum performance, we recommend replacing batteries once a year with fresh "AA" Energizer® alkaline batteries.





## Free Manuals Download Website

<http://myh66.com>

<http://usermanuals.us>

<http://www.somanuals.com>

<http://www.4manuals.cc>

<http://www.manual-lib.com>

<http://www.404manual.com>

<http://www.luxmanual.com>

<http://aubethermostatmanual.com>

Golf course search by state

<http://golfingnear.com>

Email search by domain

<http://emailbydomain.com>

Auto manuals search

<http://auto.somanuals.com>

TV manuals search

<http://tv.somanuals.com>