

TUMBLE DRYER TD163

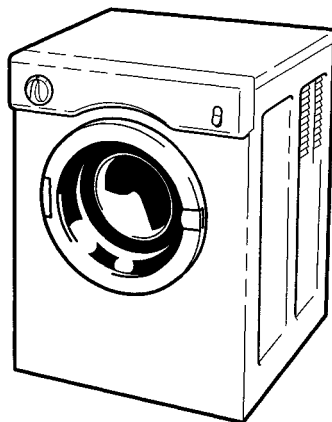

INSTRUCTION BOOKLET



IMPORTANT SAFETY INFORMATION

**This information is provided in the interest of safety.
You must read it carefully before installing or using the appliance.**

Installation

- Any electrical work required to install the appliance must be carried out by a competent qualified person.
- Do not use a two-way adaptor or extension lead. The dryer must be connected to its own socket.
- Ensure the appliance does not stand on the electrical supply cable.
- It is dangerous to alter the specifications or modify this product in any way.
- This appliance is designed to be vented through to the open air. It must have its own ventilation system which should not be shared with other appliances ventilation systems for example cooker hood outlets.

Child Safety

- Check your drum before use. Pets and children have been known to climb into tumble dryers.
- This appliance should be operated by adults. Do not allow children to tamper with the controls or play with the product.
- Keep children away from the appliance when it is in operation.

During Use

- This tumble dryer is intended for normal domestic use only.
- Clean the lint filter after each drying cycle.
- The appliance should be unplugged after use.
- Do not block the air inlets at the side of your dryer.

- Do not allow fluff to accumulate around the tumble dryer.
- Do not overload the appliance.
- Do not exceed the recommended maximum load.
- Clothes which are dripping wet must not be placed in the dryer. Only load well spun clothes.
- Do not dry items containing foam rubber or rubber like materials.
- Under no circumstances should anything other than articles recommended for tumble drying be placed in the tumble dryer.
- Do not dry items that have been in contact with flammable chemicals such as dry cleaning fluid.
- Never switch the tumble dryer off and leave a hot load in the drum.

Service

- Do not attempt to repair the appliance yourself. Repairs carried out by inexperienced persons may cause injury or serious malfunction.
- Repairs should be carried out by Zanussi Service Force. Always insist on genuine Zanussi spare parts.

**Please read this instruction book before
using the appliance, and retain for
future reference**

CONTENTS

FOR THE USER	Page	FOR THE INSTALLER	Page
Important Safety Information1		Installation Instructions11	
Installation		Technical Information	
Child Safety			
During Use		Electrical Connection12	
Service			
Description of the Appliance3		Positioning13	
Temperature Switch		Site preparation	
Time Selector Dial		Venting	
Programme Chart			
Lint Filter			
Hints & Tips on Drying4			
Drying Times5			
Operating Sequence6			
Loading the Laundry			
Selecting the programme			
When drying is complete			
Maintenance and Cleaning7			
External Cleaning			
Cleaning the Lint Filter			
Something Not Working8			
Symptoms and Solutions			
Heater cut-out			
Service and Spare Parts9			
Customer Care9			
Guarantee Conditions10			

DESCRIPTION OF THE APPLIANCE

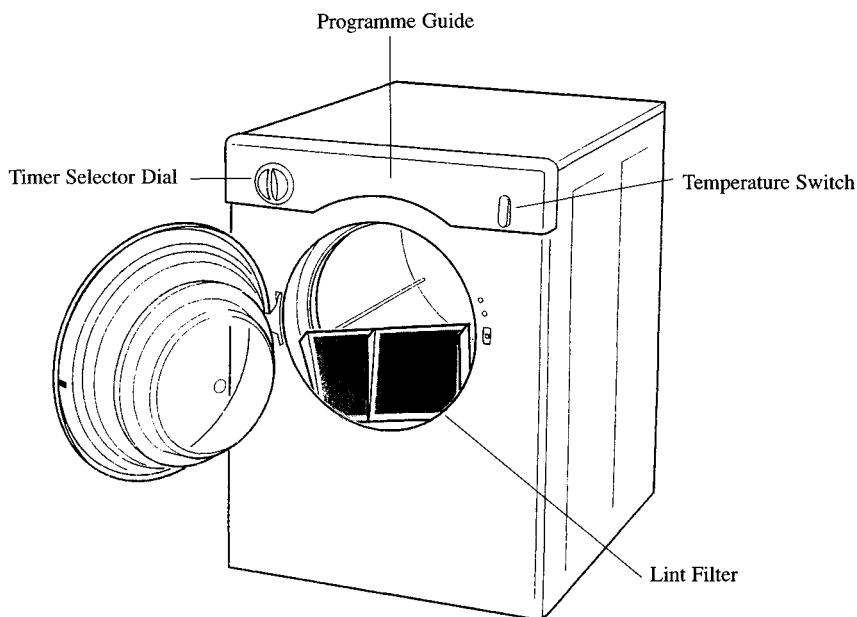

Temperature Switch

Press the bottom of the switch for a high temperature setting. Press the top of the switch for a low temperature.

Use the high temperature for drying cottons and linens, and the low temperature for drying synthetics and delicates.

Time Selector Dial

The time selector dial is marked in minutes up to a maximum of 120 minutes.

To select a drying time, turn the dial clockwise until the time you require is in line with the marker.

To reduce the drying time turn the dial anti-clockwise until the correct time is reached.

Programme Guide

This is a guide to help you select the correct temperature and drying time.

Lint Filter





The lint filter must be in position when the machine is in use. It must be cleaned after every drying cycle.

 *Do not operate the appliance with a damaged filter or with no filter at all.*

HINTS & TIPS ON DRYING

Before placing articles of laundry in your tumble dryer, check the care labels to ensure they are recommended for tumble drying.

Care labels you may find on your laundry

	Suitable for tumble drying
	Tumble dry using full heat
	Tumble dry using half heat
	Do not tumble dry

Do not overload the appliance

Here is a list of the approximate weight of some common laundry items:

Sheet	700 to 1000g
Pillowcase	100 to 200g
Tablecloth.....	400 to 500g
Table Napkin	50 to 100g
Kitchen Towel	70 to 120g
Linen Hand Towel	100 to 150g
Hand Towel	150 to 250g
Bath Towel.....	700 to 1000g
Bathrobe.....	1000 to 1500g
Shirt	200 to 300g
Apron	150 to 200g

- Always load well spun laundry. The higher the spin speed the lower the electricity consumption and the shorter the drying time.
- **DO NOT** load dripping wet laundry into the dryer. Roll the article in a towel or spin to remove excess water.
- Close poppers and zips and fasten any buttons.
- Sort the laundry. Separate synthetics from cottons/linens, and dry separately.
- Remove the laundry immediately after the programme has finished.
- Use a fabric conditioning sheet to reduce static. We recommend the sheet is pinned to an article of laundry (using a safety pin).
- Mix the load i.e. large and small articles.
- When drying items such as sheets, we recommend you periodically stop the dryer to redistribute the load.

DO NOT use the tumble dryer to dry the following:

- Articles contaminated with inflammable substances e.g. petrol, cleaning solvents, cooking oil, fats or hair lacquer.
- Woollen and synthetic wool mixtures unless the item is labelled as suitable for tumble drying.
- Very delicate articles such as silk
- Very large and bulky items such as duvets or sleeping bags.

DRYING TIMES

Cotton and Polyester Cotton

	Degree of Spin Given	Quantity	Selector Dial Setting
Store Dry	500rpm	3.0kg	120 mins
	800/1000rpm		110 mins
	2800 rpm (spin dryer)		80 mins
	500rpm	1.5kg	100 mins
	800/1000rpm		80 mins
	2800 rpm (spin dryer)		60 mins
Iron Dry	500rpm	3.0kg	100 mins
	800/1000rpm		80 mins
	2800 rpm (spin dryer)		60 mins
	500rpm	1.5kg	80 mins
	800/1000rpm		60 mins
	2800 rpm (spin dryer)		40 mins

Synthetics

	Degree of Spin Given	Quantity	Selector Dial Setting
Store Dry	500rpm	1.5kg	60 mins
	800/1000rpm		50 mins
	2800 rpm (spin dryer)		40 mins
	500rpm	0.5kg	40 mins
	800/1000rpm		30 mins
	2800 rpm (spin dryer)		20 mins

If the laundry is spin-dried in a washing machine at less than 500 rpm, the residual dampness will be higher and consequently the drying time should be increased.

This applies particularly to laundry consisting primarily of towels.

If the laundry is spin-dried at more than 1200 rpm, the residual dampness will be lower and consequently the drying time should be decreased.

OPERATING SEQUENCE

1. Loading the laundry

- Open the door by pulling it outwards
- Load the items one at a time, shaking them out loosely.
- Where possible mix the load, i.e. large and small items.
- Close the door.
- Dry your hands and plug in the appliance.

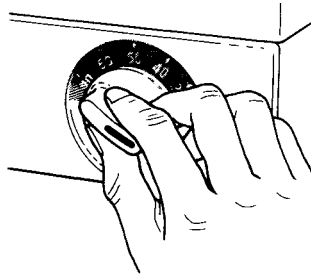
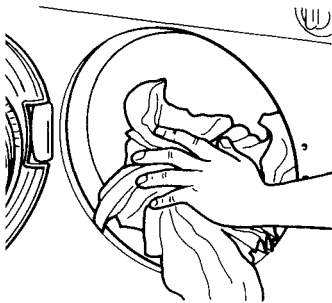

2. Selecting the programme

- Select the temperature
 - Select the required drying time
- i** Use the programme guide to help you select the correct drying time and temperature.
- i** The machine will now start working and rotate in a clockwise direction.
- To lengthen or shorten a timed programme, turn the time selector dial until the correct time is reached, bearing in mind that during the last 12 minutes the dryer carries out the cooling phase.

3. When drying is complete

- The machine stops automatically
- Remove the laundry
- Switch off the machine

i There is an automatic 12 minute cool down period at the end of every cycle, during which the heater is switched off. This helps to minimise creasing.

! *Never switch the dryer off and leave a hot load in the drum.*

The filter must be cleaned after every drying programme.

We recommend the machine is disconnected from the electricity supply when not in use.

MAINTENANCE AND CLEANING

⚠ *Disconnect the appliance from the electricity supply before carrying out any maintenance or cleaning.*

Never use abrasive cleaning products or cleaning agents which contain bleach, acetone, alcohol or methylated spirits.

External Cleaning

Periodically wipe the outside of the appliance, using only water and a soft cloth. Dry thoroughly.

Cleaning the Lint Filter

Your dryer will only function well if the filter is clean.

The filter collects fluff which accumulates during drying and it must therefore be removed and cleaned at the end of each programme.

To remove the filter:

- Pull the filter upwards and away from the appliance.
- Remove any threads of fluff by hand or with a soft brush
- Slide the filter back into position.

i Wash the filter occasionally in detergent solution using a soft brush to remove any small particles.

⚠ The lint filter must be cleaned after every drying cycle.

⚠ Keep the air inlets at the back of the appliance clear.

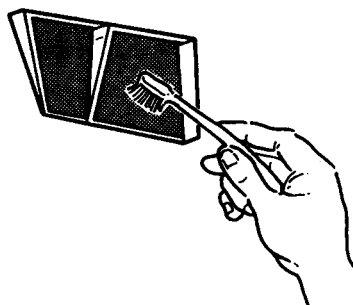
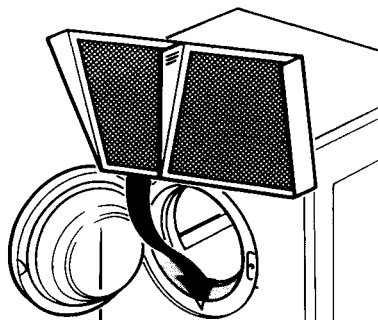

Cleaning the Door

Wipe the interior part of the door to remove any fluff.

SOMETHING NOT WORKING

Before contacting your local Zanussi Service Force please carry out the following checks.

SYMPTOM	SOLUTION
◆ The machine does not work/start	<ul style="list-style-type: none">◆ Check that there is a supply of electricity◆ Check the plug fuse◆ Check the door is closed◆ Check the machine is switched on◆ Check the time selector dial is set correctly
◆ The clothes are not dry after normal drying time	<ul style="list-style-type: none">◆ Check you have used the correct temperature setting◆ Check the vent hose is not blocked (sometimes a strong wind may cause back pressure)◆ Check the timer has not been set within a cool down period◆ The heater cut-out has operated. See below◆ Check the lint filter is clean

If the tumble dryer does not function correctly after these checks, contact Zanussi Service Force.

IMPORTANT:

If you call out an engineer to a fault listed above, or to repair a fault caused by incorrect use or installation, a charge will be made even if the appliance is under guarantee.

Heater Cut-Out

This cut-out operates if the airflow is severely restricted. Before resetting it check:

- ◆ The filter is clean.
- ◆ The air inlets at the back are not blocked.
- ◆ The exhaust venting is clear and not kinked.
- ◆ There are no other restrictions.

To reset the cut-out, press the red disk at the back of the dryer.

If the cut-out continues to operate after checking the above points you should contact Zanussi Service Force.

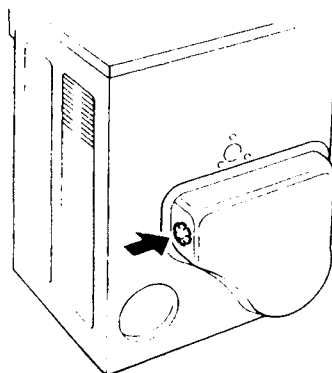

SERVICE AND SPARE PARTS



In the event of your appliance requiring service, or if you wish to purchase spare parts please contact your local Zanussi Service Force Centre by telephoning:

08705 929929 (UK)

01 409 0770 (EIRE)

Your telephone call will be automatically transferred to the Service Centre covering your post code area. For further information refer to the accompanying Customer Care booklet.

When you contact Service Force, they will need to know:

1. Your name, address and post code
2. Your telephone number
3. Clear and concise details of the fault
4. The model and serial number
5. The date of purchase

Before calling out an engineer, please ensure you have read the details under the heading 'Something Not Working'.

In-guarantee customers should ensure that the checks under the heading 'Something Not Working' have been made as the engineer will make a charge if the fault is not a mechanical or electrical breakdown.

Please note that it will be necessary to provide proof of purchase for any in-guarantee service calls.

All enquiries concerning service should be addressed to your local Service Centre.

CUSTOMER CARE

For general enquiries concerning your Zanussi appliance or for further information on Zanussi products you are invited to contact our Customer Care Department by letter or telephone at the address below, or visit our website at www.zanussi.co.uk

(UK) Customer Care Department
Zanussi
55-77 High Street
Slough
Berkshire
SL1 1DZ
Tel: 08705 727 727*

(EIRE) Customer Care Department
Zanussi
Electrolux Group
Longmile Road
Dublin 12
Tel: 01 4090 751

* calls to this number may be recorded for training purposes.

GUARANTEE CONDITIONS

Standard guarantee conditions

We, Zanussi, undertake that if within 12 months of the date of the purchase this Zanussi appliance or any part thereof is proved to be defective by reason only of faulty workmanship or materials, we will, at our option repair or replace the same FREE OF CHARGE for labour, materials or carriage on condition that:

- The appliance has been correctly installed and used only on the electricity supply stated on the rating plate.
- The appliance has been used for normal domestic purposes only, and in accordance with the manufacturer's instructions.
- The appliance has not been serviced, maintained repaired, taken apart or tampered with by any person not authorised by us.
- All service work under this guarantee must be undertaken by a Zanussi Service Force Centre.
- Any appliance or defective part replaced shall become the Company's property.
- This guarantee is in addition to your statutory and other legal rights.

Home visits are made between 8.30am and 5.30pm Monday to Friday. Visits may be available outside these hours in which case a premium will be charged.

Exclusions

This guarantee does not cover:

- Damage or calls resulting from transportation, improper use or neglect, the replacement of any light bulbs or removable parts of glass or plastic
- Costs incurred for calls to put right an appliance which is improperly installed or calls to appliances outside the United Kingdom

- Appliances found to be in use within a commercial environment, plus those which are subject to rental agreements
- Products of Zanussi manufacture which are not marketed by Zanussi.

European Guarantee

If you should move to another country within Europe then your guarantee moves with you to your new home subject to the following qualifications:

- The guarantee starts from the date you first purchased your product
- The guarantee is for the same period and to the same extent for labour and parts as exists in the new country of use for this brand or range of products
- This guarantee relates to you and cannot be transferred to another user
- Your new home is within the European Community (EC) or European Free Trade Area
- The product is installed and used in accordance with our instructions and is only used domestically, i.e. a normal household
- The product is installed taking into account regulations in your new country.

Before you move please contact your nearest Customer Care centre, listed below, to give them details of your new home. They will then ensure that the local Service Organisation is aware of your move and able to look after you and your appliances.

France	Senlis	+33 (0)3 44 62 29 99
Germany	Nuremberg	+49 (0)911 323 2600
Italy	Pordenone	+39 (0)1678 47053
Sweden	Stockholm	+46 (0)8 738 79 50
UK	Newbury	+44 (0)1635 521313

INSTALLATION INSTRUCTIONS

Technical Information

Dimensions:

Height	67 cm
Width	50 cm
Depth	53 cm
Weight	23 kg

Maximum Dry Weight Loads:

Cotton	3.0 kg
'Easycare' polyester/cotton	3.0 kg
(for minimum creasing)	1.5 kg
Delicates	1.5 kg

Electrical Ratings

Voltage	220-240v
Frequency	50Hz
Energy Consumption	2.5 kwh

ELECTRICAL CONNECTION

⚠ Any electrical work required to install this appliance should be carried out by a qualified electrician or competent person.

WARNING - THIS APPLIANCE MUST BE EARTHED

Before switching on make sure the electricity supply voltage is the same as that indicated on the appliance rating plate. The rating plate is located on the back panel of your tumble dryer.

CHANGING A FUSE

Your tumble dryer will be fitted with one of two plugs. When replacing the fuse, always use ASTA approved 13A fuses to British Standard 1362.

Type 1: Prise out the fuse cover (A) with fuse (B).
Change the fuse and refit both to the plug.

Important - The fuse cover must be refitted when changing a fuse. If the fuse cover is lost, the plug should not be used until a correct replacement is fitted. Replacements are identified by the colour insert or the colour embossed in words on the base of the plug. They are available from most electrical retail shops.

Type 2: Prise up the hinged fuse cover (A) as shown.
Replace the fuse and press the cover back into place.

FITTING A REPLACEMENT PLUG

Should the plug need to be replaced for any reason the wires in the mains lead are coloured in accordance with the following code:

Blue	- Neutral 'N'
Brown	- Live 'L'
Green and Yellow	- Earth 'E'

The **GREEN & YELLOW** wire must be connected to the terminal in the plug which is marked with the letter 'E' or by the earth symbol \perp or coloured green or green and yellow.

The **BLUE** wire must be connected to the terminal marked with the letter 'N' or coloured black.

The **BROWN** wire must be connected to the terminal that is marked with the letter 'L' or coloured red.

⚠ A cut off plug inserted into a 13 amp socket is a serious safety (shock) hazard. Ensure that the cut off plug is disposed of safely.

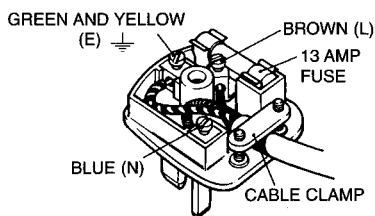
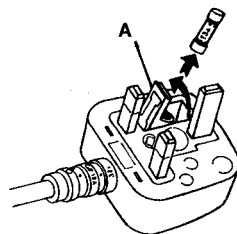
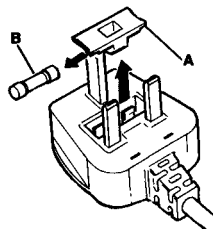

POSITIONING

Site Preparation

- The installation surface must be clean and dry.
- Do not install on a deep pile carpet.
- Do not install the appliance where the temperature may fall below freezing or rise above 35°C.
- Do not use a two way electrical adaptor or extension lead. The dryer must be connected to its own socket.
- Please ensure that when the appliance is installed it is easily accessible for the engineer in the event of a breakdown.

Venting

Whilst drying, the tumble dryer will expel a certain amount of warm, very moist air, which should be removed from the room as quickly as possible to prevent condensation.

Use a vent hose to direct the warm air to an open window or door. (available as an optional extra)

 *The vent must not be connected to any cooker hood ducting, chimney, or fuel pipe designed to carry exhaust from a fuel burning heating appliance.*

ZANUSSI

Zanussi Ltd., 55-77 High Street, Slough, Berkshire SL1 1DZ

Free Manuals Download Website

<http://myh66.com>

<http://usermanuals.us>

<http://www.somanuals.com>

<http://www.4manuals.cc>

<http://www.manual-lib.com>

<http://www.404manual.com>

<http://www.luxmanual.com>

<http://aubethermostatmanual.com>

Golf course search by state

<http://golfingnear.com>

Email search by domain

<http://emailbydomain.com>

Auto manuals search

<http://auto.somanuals.com>

TV manuals search

<http://tv.somanuals.com>