

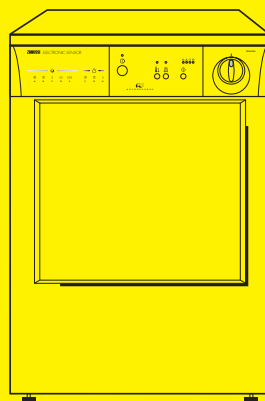



ZANUSSI

TUMBLE DRYER SECADORA SECADOR TDE 4224



- GB  **Unpacking:** see page 7
- E  **Desembalaje:** ver página 21
- P  **Desembalagem:** ver página 35

INSTRUCTION BOOKLET
INSTRUCCIONES PARA EL USO
INSTRUÇÕES DE UTILISAÇÃO

GB
E
P

125994492

Dear customer,

Please read these operating instructions carefully and pay particular attention to the safety notes indicated in the first pages.

We recommend that you keep this instruction booklet for future reference and pass it on to any future owners.

Transport damages

After unpacking the machine please check it is not damaged. If in doubt, do not start it but contact your local Service Centre.

The symbols you will see on some paragraphs of this booklet have the following meaning:



The warning triangle emphasize information that is particularly important for your safety or correct functioning of the appliance.



The information marked with this symbol provides additional instructions and practical tips on the use of the appliance.



Tips and information about economical and ecological use of the machine are marked with this symbol.

Our contribution to the protection of the environment: we use recycled paper.

Contents

Important safety information	4	Maintenance and Cleaning	14
Disposal	5	External cleaning	14
Tips for environmental protection	5	Cleaning the door.....	14
Description of the appliance	6	Cleaning the filters	14
Installation	7	Something not working?	15
Unpacking	7		
Positioning	7		
Fitting the vent hose	7-8		
Electrical connection	8		
Stacking kit.....	8		
Door reversal	8		
Use	9		
The control panel	9-10		
Programme chart	11		
Operating sequence.....	12		
Useful hints	13		

Technical specifications

DIMENSIONS:	Height	85 cm
	Width	60 cm
	Depth	58 cm
ELECTRICAL CONNECTION:		220/230 V/50 Hz
MAX. POWER ABSORBED:		2200 W
MIN. FUSE RATING:		10 A
MAX. DRYING CAPACITY:	Cotton, linen	5 kg
	Synthetics	2.5 kg
CONSUMPTION:	Cotton, linen	3.3 kWh (5 kg store dry)
	Cotton, linen	2.7 kWh (5 kg iron dry)

CE This appliance complies with the following E.E.C. Directives:
 - 73/23 EEC of 19.2.73 (Low Voltage Directive) and subsequent modifications;
 - 89/336 EEC of 3.5.89 (Electromagnetic Compatibility Directive) and subsequent modifications.



Important safety information

These warnings have been provided in the interest of safety. You MUST read them carefully before installing or using the appliance.

Installation

- Any electrical work required to install this appliance should be carried out by a qualified electrician or competent person.
- Care must be taken to ensure that the appliance does not stand on the electrical supply cable.
- If the machine is situated on a carpeted floor, please adjust the feet in order to allow air to circulate freely.
- This tumble dryer is designed to be vented through to the open air. It should have its own ventilation system which should not be joined with any other ventilation system connected to any other appliance.

Use

- This appliance is designed for domestic use only. If the machine is used for any other purposes or is not used correctly, the manufacturer accepts no responsibility for any damage that might occur.
- Always unplug the appliance after use.
- Clothes which are dripping wet should not be placed in the dryer.
- **Danger of explosion:** Never tumble dry items that have been in contact with inflammable solvents (petrol, methylated spirits, dry cleaning fluid and the like). As these substances are volatile, they could cause an explosion. Tumble dry only items washed with water.
- Please make sure that no gas lighters have accidentally been left in pockets of garments to be loaded into appliance.
- Do not dry canvas shoes or sports shoes, as they could get stuck between the door and the drum, thus blocking this latter.
- Leave the door slightly ajar when the appliance is not being used. This will allow the seal to be preserved.
- Clean fluff filters after using the tumble dryer. To prevent fire risks, **do not use the appliance if the fluff filters are damaged or without filters.**
- Do not allow fluff to accumulate around the dryer.

General safety

- It is dangerous to alter the specifications or attempt to modify this product in any way.
- Under no circumstances should you attempt to repair the machine yourself. Repairs carried out by inexperienced persons may cause injury or serious malfunctioning. Contact your local Zanussi Service Centre. Always insist on genuine Zanussi spare parts.

Child safety

- Children are often not aware of how dangerous electrical appliances can be. When the machine is working, children should be carefully supervised and not be allowed to play with the appliance.
- The packaging components (e.g. plastic film, polystyrene) can be dangerous to children - danger of suffocation! Keep them out of children's reach.
- Make sure that children or pets do not climb into the drum.
- When the appliance is to be scrapped, cut off the electrical supply cable and destroy the plug with the remaining cable. Disable the door catch in order to prevent children from becoming trapped inside while playing.

Disposal

• Packaging materials

The materials marked with the symbol  are recyclable.

This means that they can be recycled by disposing of them properly in appropriate collection containers.

• Machine

Use authorised disposal sites for your old appliance. Help to keep your country tidy!

Tips for environmental protection

To save energy and to help protect the environment, we recommend that you follow these hints:

- Try to load the maximum capacity of the machine as small loads are **uneconomical**.
- Always load well spun laundry. The higher the spin speed, the lower the electricity consumption and the shorter the drying times.
- Do not over-dry laundry, this avoids creasing and saves energy.
Select the drying programme according to the type of laundry and the required degree of dryness.
- To utilize the maximum load, laundry which is to be dried ready to put away (store dry) can be dried together with items to be ironed. To do this, select the programme for iron-dry, remove the iron-dry items at the end of the programme and then finish-dry the rest of the load.
- Clean the filters regularly to avoid excessive drying times and high electricity consumption.
- Ventilate the room well. The room temperature should not exceed +35°C during drying.

Description of the appliance

- 1 Control panel
- 2 Fluff filters
- 3 Rating Plate
- 4 Adjustable feet

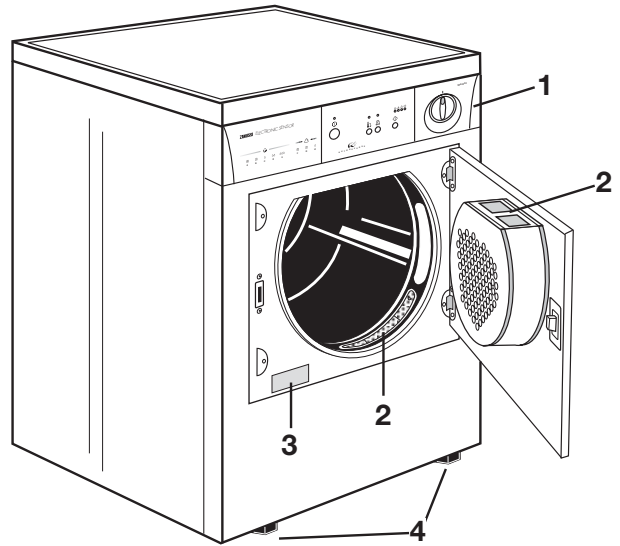

- 5 Side vent outlets
- 6 Ring nut
- 7 Rear vent outlet

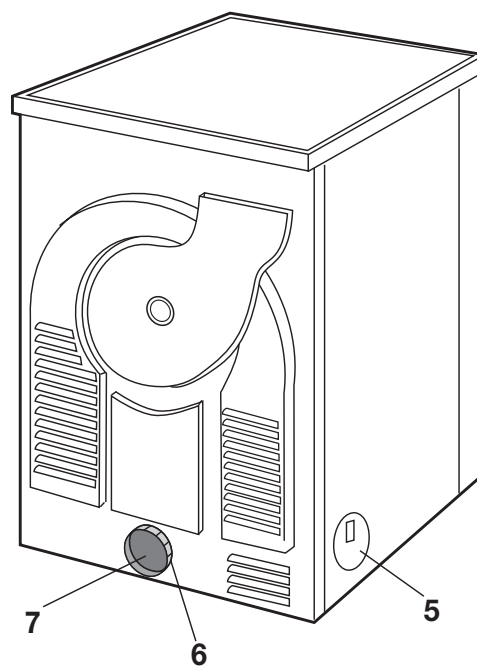

Installation

Warning!

Unpacking

 Slide out the polythene bag with the polystyrene stuffing before using the appliance.

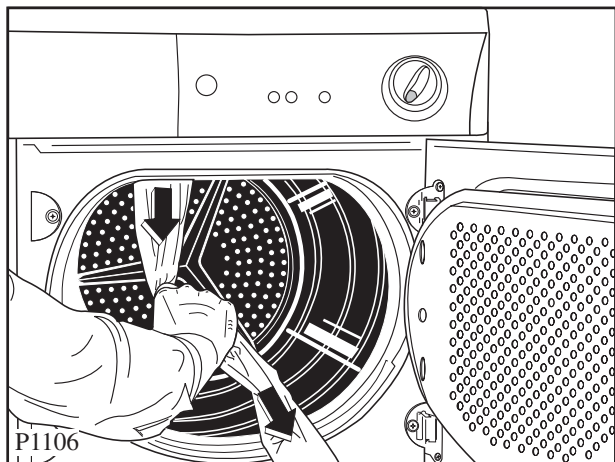

Positioning

It is recommended that, for your convenience, the machine is positioned close to your washing machine. Whilst drying, the tumble dryer will expel a certain amount of warm, very moist air, and this should be removed from the room as quickly as possible to prevent condensation. In an extremely well ventilated room or close to an open window, this may occur naturally.

However, in general, it is better to carry the dryer's exhaust outside via the 100 mm diameter flexible hose supplied with the appliance; ending either temporarily at an open window, or permanently at a fixed ventilation grille, fitted to an exterior wall or window.

The tumble dryer must be installed in a clean place, where dirt does not build up.

Make sure there are no obstructing items or material near the air-intake louvres provided at the back (e.g. paper, rags etc.).

To keep vibration and noise to a minimum when the dryer is in use, it should be placed on a firm, level surface.

Once in its permanent operating position, check that the dryer is absolutely level with the aid of a spirit level. If it is not, raise or lower the feet until it is.

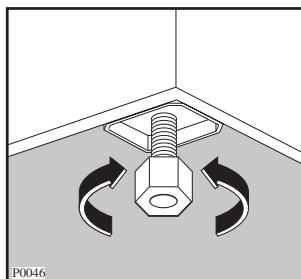

The feet must never be removed.

Do not restrict the floor clearance through deep-pile carpets, strips of wood or similar. This might cause heat build-up which would interfere with the operation of the appliance.

Important

When operating the tumble dryer, the room temperature must not exceed 35°C, as it may affect the performance of the appliance.

Fitting the vent hose

To simplify the installation, there is a choice of vent outlets: one at the back, the others in the left and right-hand side.

Connect the hose to whichever is the more convenient by pulling the ring nut (A) from the vent outlet at the back, screwing it on to the hose and pushing it firmly back into place.

The unused vents should now be sealed with the special snap covers provided.

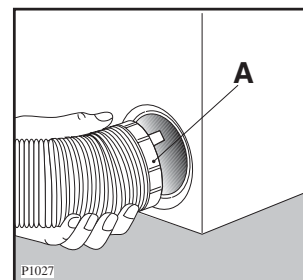
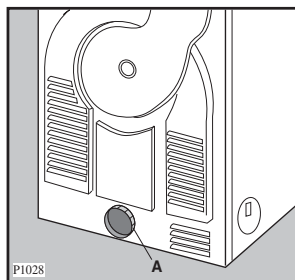

Advice: If the hose is long and the room temperature low, the moisture might condense to water inside the hose. **This is an unavoidable natural phenomenon.** To prevent this water from lying in the hose or flowing back into the tumble dryer, it is advisable to drill a small hole (dia. 3 mm) in the lowest point of the hose and to place a small container below it. (See picture, point B).

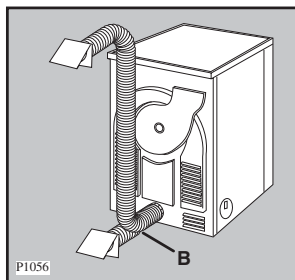

Once connected to the dryer, run the vent hose to the desired outlet point, ensuring that the run's overall length is less than 2 m, and that it contains no more than two bends. As to the outlet itself, if you have decided on a fixed wall/window grille, a good local builder's merchant should be able to supply you with the necessary fittings and installation advice.



It is important not to connect the vent hose to, for example, a cooker hood, or a chimney or flue pipe designed to carry the exhaust from a fuel burning appliance.

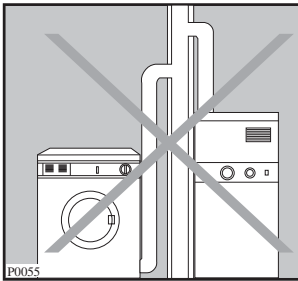

Note that to avoid condensation problems, it is essential that the dryer be fitted with the flexible hose to carry its "exhaust" at least beyond the kitchen units; preferable outside the kitchen.

In order to prevent the appliance from overheating, it is important that the steam exhaust is unobstructed. Therefore, in case of a permanent hose fitted to an exterior wall or ceiling, it must be ensured an exhaust capacity of at least 150 m³/h.

If the dryer is fitted next to kitchen units, make sure that the vent hose is not squashed. If the hose is partially squashed, drying efficiency will be reduced, resulting in longer drying times and higher energy consumption.

If the hose is completely squashed, the safety cut-outs with which the machine is fitted may operate.

Electrical connection

This machine is designed to operate on a 220-230 V, single-phase, 50 Hz supply.

Check that your domestic electrical installation can take the maximum load required (2.2 kW), also taking into account any other appliances in use.

Connect the machine to an earthed socket, in accordance with current wiring regulations.



The manufacturer declines any responsibility for damage or injury through failure to comply with the above safety precaution.

Stacking kit

A special stacking kit is available through your dealer, to enable the mounting of the dryer on top of your washing machine.

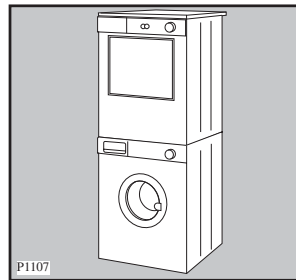

Door reversal

To make it easier to load or unload the laundry the door can be reversed.

This operation must be carried out by qualified personnel.

Please contact the nearest Zanussi Service Centre.

Use

The control panel

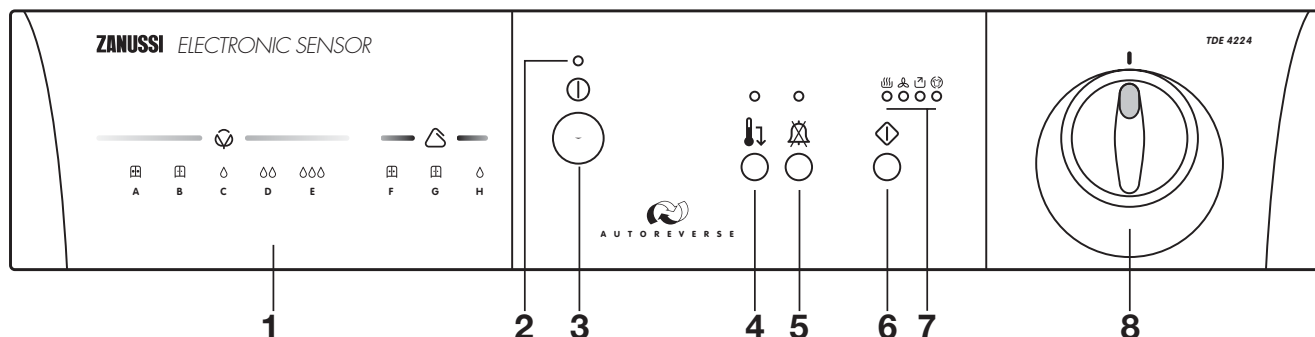

1 Programme chart

This will help you to select the correct programme for drying.

2 Mains-ON light

Comes on when the appliance is switched on (ON/OFF button pressed down) and goes out when this button is released.

3 ON/OFF button

This button is used to switch the dryer on. At the end of the programme, release this button by pressing it again to switch the dryer off.

4 Low temperature button

Pressing this button allows drying to be performed at a lower temperature, for delicate items. The corresponding pilot light comes on.

5 Buzzer OFF button

A buzzer sounds during the anti-creasing phase. Press this button when selecting the programme if you wish to switch the buzzer off. The corresponding light illuminates.

6 Start button

Press this button for about 2 seconds to start the dryer after having selected the programme.

If the door is opened while the programme is running, this button must be pressed again after closing the door in order to restart the programme from the point at which it was interrupted.

This button must also be pressed after a power cut. In both cases light or (depending on the phase in progress) flashes to remind you that the start button needs to be pressed again.

7 Programme phase indicator lights

These lights indicate the various phases of the programme as they are being performed.

“Drying” light

This light indicates that the appliance is in the drying phase.

“Cooling” light

This light indicates that the appliance is in the cooling phase. At the end of drying, there is a 10 minute cooling phase to cool the laundry.

If light or is flashing, this means that the Start button needs to be pressed again for the programme to resume.

“End of programme” light

This light flashes at the end of the cooling phase and during the anti-creasing phase.

“Anti-creasing phase” light

This light flashes alternately with the light  at the end of the drying phase (after cooling) and during the anti-creasing phase.

If only light  flashes, this means that the anti-creasing phase has finished.

8 Programme/Time selector dial

Allows you to select electronically controlled or time controlled drying.

Turn the dial to the required programme or time.

Electronically controlled drying (automatic)

The appliance runs these programmes with the help of probes which detect the degree of dampness of the laundry.

Simply select the programme according to the type of laundry and degree of drying required.

Time controlled drying

Can be used to finish off drying if necessary.











Select the 60 minute programme for cottons or the 30 minute programme for synthetics.

To cancel a programme which is running, turn the programme selector dial to “0”.

At the end of drying, turn the selector dial to “0” before removing the laundry.



Programme chart

Automatic drying (electronic programmes)

Type of laundry	Degree of drying required	Max-load ⁽¹⁾ kg	Programme
Cotton & linen 	extra dry 	5	A
	store dry 	5	B (*)
	slightly damp 	5	C
	iron dry 	5	D (*)
	machine iron dry 	5	E
Synthetics 	extra dry 	2.5	F
	store dry 	2.5	G (*)
	slightly damp 	2.5	H

(*) According to CEI 1121 Standards.

Time controlled drying

Type of laundry	Drying time	Max-load ⁽¹⁾ kg	Programme selector dial position
Cotton 	60 min	5	60'
Synthetics 	30 min	2.5	30'

(1) Never overfill the drum (do not load large quilts, for example).

Drying times vary according to:

- The type of laundry
- The size of the load
- The degree of spinning prior to drying.

Fresh & Cool

This position on programme selector dial can be used to freshen the laundry (e.g. to remove a persistent odour of moth-balls).

Load

It is often difficult to estimate the weight of items to be dried. We therefore recommend that you adopt the following guidelines:

- **cotton, linen:** drum full but not too tightly packed;
- **synthetics:** drum no more than half full;
- **delicate fabrics:** drum no more than one third full.





i Operating sequence

Before using your tumble dryer for the first time, we recommend to place a few damp cloths inside the appliance and dry for 30 minutes. There may be dust inside a brand new tumble dryer.

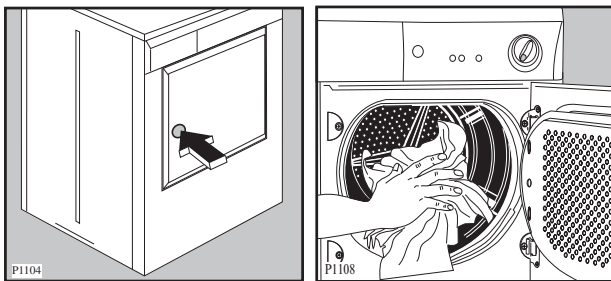
Drying

1. Connect the appliance.
2. Open the door.





3. Load the items one at a time, shaking them out loosely.
4. Close the door. Please check the laundry does not get caught between the door and filter.
5. Press the ON/OFF button : the mains-ON light comes on.
6. Select the drying programme or time.
7. If required, press the low temperature button  and/or the buzzer OFF button .
8. Press the Start button  for 2 seconds: light  comes on and drying starts.
The drum turns alternately in both directions during drying.
9. If the laundry is not removed at the end of the cycle, the dryer performs an **anti-creasing** phase (duration: 30 minutes maximum).

All drying programmes end with a 10 minute cooling phase (light  is on).
You may remove the laundry after this phase.

The buzzer sounds every 10 seconds (if the  button has not been pressed).

Lights  and  flash alternately.

If you do not remove the laundry, the dryer will stop automatically at the end of the anti-creasing phase.

Light  flashes and the mains-ON light stays on.
Turn the programme selector dial to "0"; light  goes out.

Release the ON/OFF button (the mains-ON light goes out) and immediately remove the laundry.

After each use

- Turn the programme selector dial to "0".
- Switch the appliance off by releasing the ON/OFF button . The mains-ON light goes out.
- Clean the filters (see page 14).

Important!

If the drying programme has to be stopped before it reaches the end, we recommend that you turn the programme selector dial to position  (cooling) and wait until the end of this phase before removing the laundry. This will avoid a build-up of heat inside the appliance.





Modifying the programme

To change a programme which is running, first cancel it by turning the programme selector dial to "0". Select the new programme and press the Start button .

Useful hints

- Try to load to the maximum capacity of the machine as small loads are uneconomical. For information, here is a list of the average weights of some common laundry items.

Sheet	700 - 1000 g
Tablecloth	400 - 500 g
Kitchen towel	70 - 120 g
Table napkin	50 - 100 g
Towelling hand towel	150 - 250 g
Bathrobe	1000 - 1500 g
Man's shirt	200 - 300 g
Pillowcase	100 - 200 g
Man's pyjamas	400 - 500 g
Ladies' nightdress	200 - 250 g

- Never tumble dry the following: Particularly delicate items such as net curtains, woollen, silk, fabrics with metal trim, nylon tights, bulky materials such as anoraks, blankets, eiderdowns, sleeping bags, feather quilts and any items containing rubber foam or materials similar to rubber foam.
- Always follow the instructions on garment labels:
 -  may be tumble dried
 -  normal drying (high temperature)
 -  delicate drying (low temperature)
 -  do not tumble dry
- Close pillowcases and covers with fasteners to prevent small laundry items getting tangled inside them. Close press studs, zips and hooks and tie belts and apron strings.
- Sort laundry according to type and degree of drying required.
- Do not over-dry laundry, this avoids creasing and saves energy.

- Avoid drying dark clothes with light coloured fluffy items such as towels as they could attract the fluff.
- The laundry must be thoroughly spun before tumble drying.
- **Easy-care items**, too, e.g. shirts, should be briefly pre-spun before drying (depending on crease resistance approx. 30 seconds or using the special brief spin programme of your washing machine).
- Knitted textiles (knitted underwear) may shrink a little during drying. Please do not overdry items of this type. It is advisable to allow for shrinkage when choosing the size of new purchases.
- You can also put starched items into your dryer. However, to achieve the desired starched effect, choose the programme "iron dry". To remove any starch residues, wipe out the internal drum after drying with a moist cloth and then rub it dry.
- To avoid a static charge when drying is completed, use either a fabric softener when you are washing the laundry or a fabric conditioner specifically for tumble dryers.
- Remove the laundry when the dryer has finished drying.
- If individual items are still damp after drying, set a brief post-drying time, but **at least 30 minutes**. This will be necessary particularly for multilayered items (e.g. collars, pockets, etc.).

Maintenance and Cleaning

You must **disconnect** the appliance from the electricity supply, before you can carry out any cleaning or maintenance work.

External cleaning

Use only soap and water and then dry thoroughly.

Important: do not use methylated spirit, diluents or similar products.

Cleaning the door

Clean periodically the interior part of the door to remove any fluff from the seals around the filter. Accurate cleaning ensures correct drying.

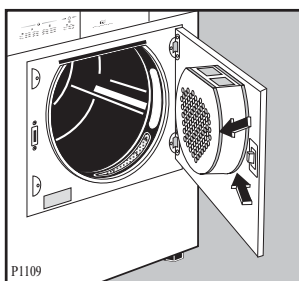

If necessary the filters can be cleaned under running water using a brush. In this case remove the filter in the door opening as per picture (it can be positioned with the tooth facing to the left or to the right).

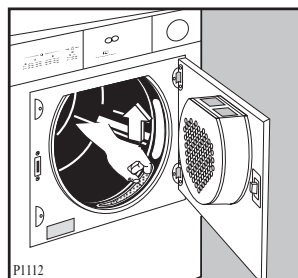

Cleaning the filters

Your dryer will only function well if the filters are clean.

The filters collect all the fluff which accumulates during drying and they must therefore be cleaned at the end of each programme, before removing the laundry, with a damp cloth.

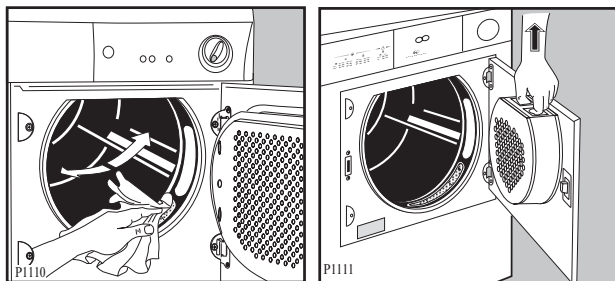



The filter in the inner door must be removed for cleaning.

Do not be alarmed by the amount of fluff. It is not due to excessive wear caused by the dryer. All fabric loses fluff when drying but it goes un-noticed in the air. In a tumble dryer it simply collects in the filter.

Something not working?

Before contacting your local Zanussi Service Centre, please make the following checks:

Problem	Possible cause
<ul style="list-style-type: none"> • The dryer does not work: 	<ul style="list-style-type: none"> • The door is open. • The plug is not fitted into the wall socket. • There is no electricity supply from the wall socket. • The selector dial is not set correctly. • The start button  has not been depressed.
<ul style="list-style-type: none"> • The dryer does not dry properly: 	<ul style="list-style-type: none"> • The filters are clogged. • The selected cycle is not suitable for the laundry. • The laundry has not been spun properly. • The low temperature function  has been selected. • Excessive laundry load. • The dryer is not correctly installed.

If, after the above checks, there is still a fault, call your local Zanussi Service Centre.

Please make sure you give the model and serial number of the appliance.

This information can be found on the rating plate (see picture on page 6).



Free Manuals Download Website

<http://myh66.com>

<http://usermanuals.us>

<http://www.somanuals.com>

<http://www.4manuals.cc>

<http://www.manual-lib.com>

<http://www.404manual.com>

<http://www.luxmanual.com>

<http://aubethermostatmanual.com>

Golf course search by state

<http://golfingnear.com>

Email search by domain

<http://emailbydomain.com>

Auto manuals search

<http://auto.somanuals.com>

TV manuals search

<http://tv.somanuals.com>