

B12

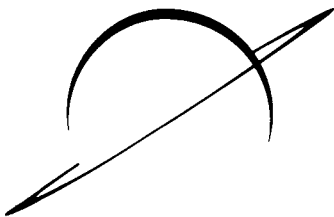

INSTRUCTION BOOK DEPT.
LIBRARY
MASTER COPY

ZANUSSI

Instructions for the use and care of EC 19 cooker

WARNING

THE INSTRUCTION REGARDING THE
POSITION OF THE HOTPLATE WHICH CAN
BE AUTOMATICALLY CONTROLLED IS
INCORRECT, THE TEXT SHOULD READ
"REAR LEFT" AND NOT "FRONT LEFT"

B12

Contents

Instructions for the owner

Installation	Page 3
Technical data	Page 3
Care and use.	Page 4
Using the oven	Page 7
Electric programmer	Page 8
Cooking procedure	Page 11
Maintenance & cleaning	Page 12

Instructions for the installer

Installation	Page 17
Electrical connection	Page 18
What happens if something goes wrong	Page 19

Caution

Before you start operating the appliance, be sure to remove the plastic films protecting the stainless steel or anodized aluminium parts.

Important: As the grill heater is placed on the upper part of the oven, the door should be left closed during the grill cooking.

Instructions for the owner

Installation

It is mandatory that all operations required for the installation be carried out by **QUALIFIED PERSONNEL** in accordance with existing rules and regulations. The relevant instructions are to be found in the special chapter for the installer.

Warning

During normal cooking the oven heats up considerably at the level of the glass window of the door and other adjacent parts. That is why one should make sure that children do not touch the oven.

Important:

If other home appliances are connected to sockets that are very close to the oven, make sure that the supply cord of the appliance does not come in touch with burning hot plates or heat areas and, furthermore, that it does not get stuck in the hot oven door.



A0136

Technical data

Dimensions:

Height	mm.	900
Depth	mm.	598
Width	mm.	597
Oven capacity	cu.dm.	53
Cooking programmer		DIEHL 12 h

Hob*

Rear left dia.	mm.	180 (T)	2000 W
Front left dia.	mm.	180 (N)	1500 W
Rear right dia.	mm.	220 (N)	2000 W
Front right dia.	mm.	145 (R)	1500 W
Maximum power absorbed			7.0 kW

Oven

Oven heating element		2.5 kW
Energy regulated extractable grill		2.0 kW
Oven lamp		15 W
Hot-air convection fan		35 W
Maximum power absorbed		2.550 kW
Power Supply (50 Hz)		240 V
Total power		9.550 kW

(* The front left heating element is automatically switched on or off by means of the electric programmer.

T = Electric cooking plate adjusted thermostatically.

N = Normal electric cooking plate;

R = Rapid electric cooking plate.

This appliance meets the requirements laid down in EEC Directive No. 82/499 dated 7/6/1982 relating to the suppression of radio and TV interferences.

Use and care

- A** - Enamelled cover
- B** - Hob with electric plates
- C** - Control panel
- D** - Side grilles
- E** - Grilles
- F** - Dripping pan
- G** - Oven door
- H** - Removable drawer
- I** - Front panel
- J** - Removable base

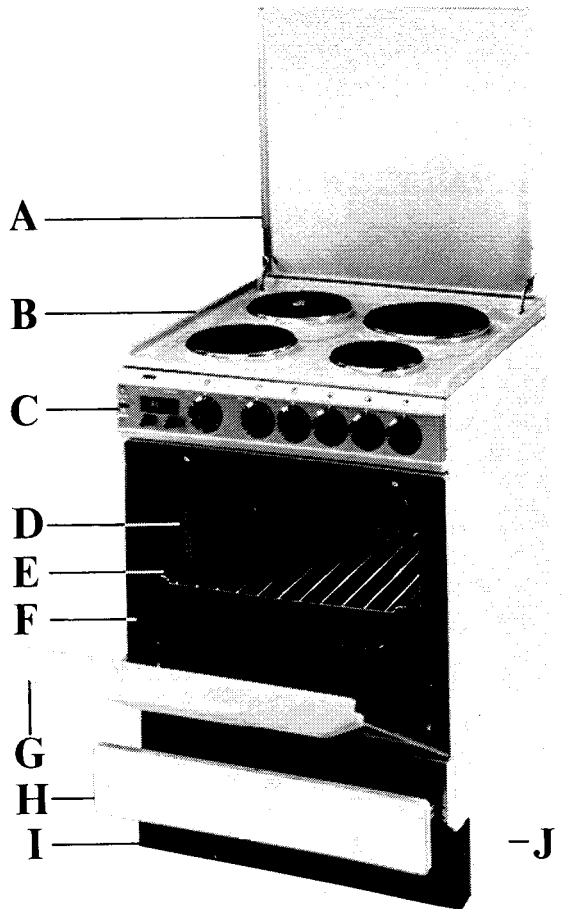

- K** - Grill or roasting pan
- L** - Reversible grill pan insert
- M** - Removable handles (2 Off.)

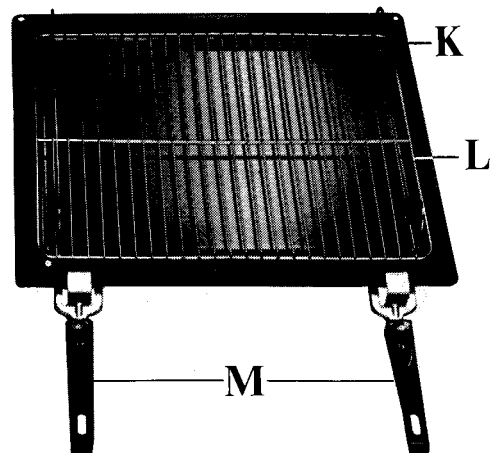

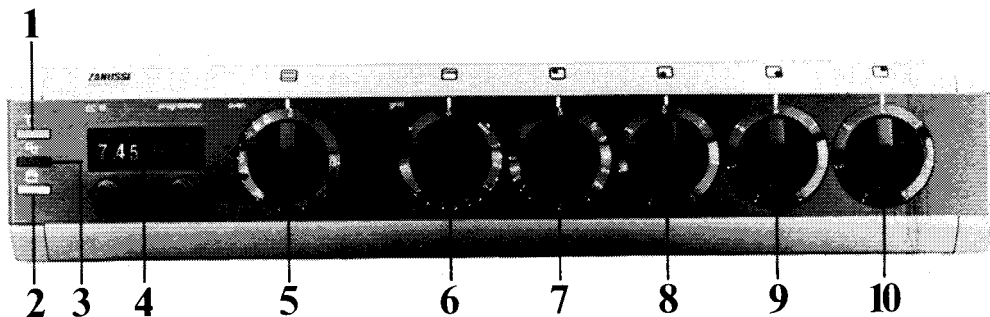

Control panel

- 1 - Thermostat control light
- 2 - Grill control light
- 3 - General control light
- 4 - Programmer
- 5 - Oven knob
- 6 - Grill knob
- 7 - Rear left heat zone control knob
- 8 - Front left heat zone control knob
- 9 - Front right heat zone control knob
- 10 - Rear right heat zone control knob

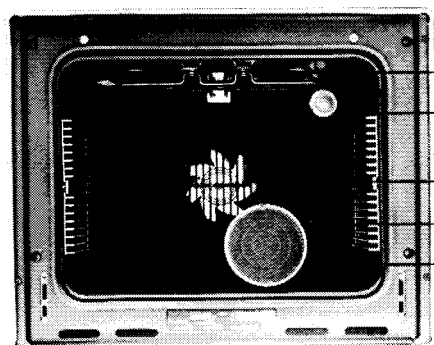

Oven

- N - Removable grill
- O - Oven light
- P - Fan
- Q - Filter
- R - Enamelled panels

Operation

Electric plates

The control panel includes knobs for operating the four heating elements on the hob.

Three plates are controlled by a switch (fig. 1) by means of a 6-position knob:

0 = Off

1 = Minimum electric plate power

6 = Maximum electric plate power

Increased power values are given by intermediate positions 2, 3, 4, 5 respectively.

The fourth electric plate is controlled by a 12-position knob (fig. 2), the temperature selected for cooking is maintained constant by a thermostat. In these conditions the electric plate supplies exclusively the appropriate heat.

Important

During cooking on the hob when fats or oils are used pay particular attention since these may overheat and consequently flare up.

Programmed heating element

The front left heating element can be programmed to switch on and off automatically at a preset cooking time; the operations for the programming are described in the paragraph «Electric programmer».

Useful hints

Maximum service life of the electric plates and saving of electric energy can be achieved by taking following precautions:

use only pots and pans with a flat bottom and having a diameter at least equal to that of plates;

avoid boiling liquids spilling from pots or pans on to the electric plates;

never leave the electric plates switched on without a pot or a pan on them or only with an empty pot or pan on them.

Electric oven

A fan provided on the oven's bottom side distributes warm air all around the food during cooking so that the entire oven is heated up evenly and all food is cooked at the same time regardless of where it is placed in the oven or of how much is being cooked.

Foods of different types may be cooked simultaneously, provided they require the same cooking temperature, and there is no possibility of any flavours or smells being transmitted from one food to another.

The oven has a removable grill.

Cooking by either oven or grill can be manual or automatic (with or without the programmer). This includes a digital clock, a minute minder and controls by which the oven can be set to come on and go off unattended.

The indicator lights on the control panel show when the oven and the grill are switched on, the behaviour of the thermostat during cooking.

A light comes on inside the oven when it is switched on and remains on until the oven goes off.

The grill cannot be used at the same time as the oven.

The grill control provides a variety of heat settings.

Important

Caution must be taken when the grill is used and children must be kept away during its operation.

Using the oven

As soon as the oven is switched on the fan starts and runs until the oven control is switched off again (fig. 3).

The food should be put into the oven before switching on, even when cooking manually, the speed of heating up is so fast that there is no need to preheat. The oven shelves can be fully filled. Most normal types and materials of cooking utensils can be used. During cooking the door should be opened as little as possible to avoid heat loss and consequently excessive electricity consumption.

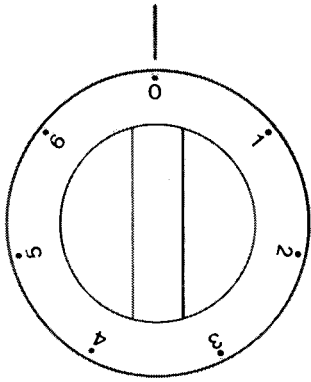

A0195

fig. 1

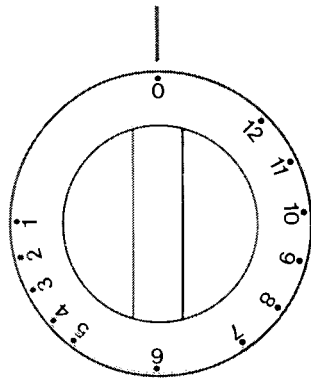

A0196

fig. 2

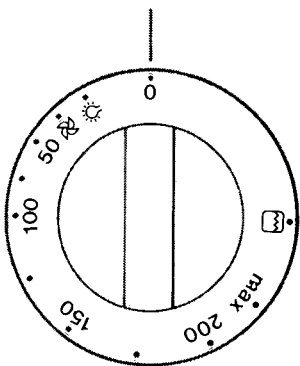

A0154

fig. 3

Cooking manually

When cooking manually make sure that the programmer is not in operation accidentally.

Arrange the food in the oven, shut the door and turn the oven control knob (See fig. 3) to the required temperature setting.

When the knob reaches the symbol ☐ both the oven operating light and the oven temperature light come on simultaneously.

This setting, which is not a cooking position, is intended for rapid thawing of frozen food.

Positions from 50°C to MAX are cooking positions and give a full range of temperatures.

The oven temperature light will come on until the oven has reached the correct temperature; after that it will come on and off showing how the temperature is being maintained.

Cooking automatically

The oven or grill can cook automatically when the programmer is set to switch it on and off at the times given without the need for anyone to be in attendance.

Most food cooks well automatically but preference should be given to those which will not be affected by the waiting period before the oven comes on.

Electric programmer

The electric programmer makes it possible for the oven and/or front left electric plate of the hob to be turned on and off automatically at the pre-set time. Furthermore, the programmer will show the time of the day and will also produce an acoustical signal at the end of the cooking cycle.

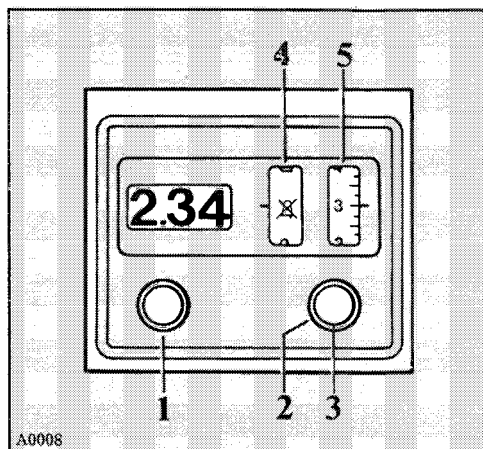

fig. 4

Operating the electric programmer

Figure 4 shows the control knobs of the electric programmer.

With knobs 1, 2 and 3 you can carry out all required adjustments, as described here below.

Knob 1

By turning this knob clockwise, you can set the programmer to the correct time when the appliance is installed, after a power failure or to anticipate or delay time, etc.

Knob 2

By turning this knob clockwise, you can set the following functions on dial 4:

Cooking duration (210 mins. max);

Stopping the ringing bell (position 

Manual operation of the oven (position ).

Knob 3

By depressing and turning this knob clockwise as well as anticlockwise, you can set the cooking start time on dial 5.

Attention

When setting the programmer to the correct time of the day, make sure that both the electric clock and dial 5 actually show the same time.

Manual operation of the oven and/ or of the front left heating element

For manual operation of the oven and of the front left heating element it is necessary that the dial setting be positioned on  otherwise the appliance does not operate.

Turn knob 2 (fig. 4) clockwise until symbol  coincides with the index of the dial.

Furthermore, the time indicated by dial 5 must be the same as that of the clock, otherwise correct it by means of knob 3.

Semi-automatic operation of the oven and/ or of the front left heating element

1st alternative

Start cooking immediately through manual operation; end of cooking through the electric programmer (automatic).

Place the food to be cooked and rotate clockwise knob 2 and set cooking time on dial 4.

Turn the knob of the oven and/ or of the front left heating element to the required temperature value.

2nd alternative



Start cooking through the programmer (automatic) and end of cooking through the manual operation.

Place the food to be cooked, depress knob 3 and turn it clockwise until the cooking start time appears on dial 5.

Turn knob 2 clockwise and set the maximum cooking duration (210 mins) on dial 4.

Turn the oven knob and/ or the front left heating element knob to the required temperature.

Important

When the cooking time has elapsed, turn knob 2 clockwise until the «0» coincides with the index on dial 4. Then turn it to  and finally to .

Fully automatic operation of the oven and/ or of the front left heating element

Place the food to be cooked and turn knob 2 clockwise and set the required cooking time (max. 210 mins) on dial 4.

Depress knob 3 and turn it clockwise until the cooking start time appears on dial 5. Turn the oven knob and/ or the front left heating element knob to the required temperature.

After completion of the cooking cycle, the symbol «0» will coincide with the index on dial 4.

On this setting, the oven and/ or the heating element are electrically turned off. Furthermore, the buzzer reminds you that the cooking cycle is completed.

To turn off the buzzer, turn knob 2 clockwise until the symbol  coincides with the index on dial 4.

Example of how to use the automatic programmer for the oven and/ or the heating element

Cooking end time: 19.00 hours.

Cooking duration: 2 hours (120 mins).

Place the food to be cooked, turn knob 2 clockwise and set the cooking duration (120 mins) on dial 4.

Depress knob 3 and turn it clockwise until you set on dial 5 the cooking start time (5 o'clock = 17.00 hours).

Turn the oven and/ or front left heating element control knob to the required temperature.

After this, the oven and/ or heating element will automatically turn on at 17.00 hours and then off at 19.00 hours after completion of the cooking cycle.

Minute minder

The programmer can operate as a minute minder only if no automatic cooking has been programmed and if the oven and the front left heating element are not operating.

To operate the minute minder turn knob 2 clockwise until the required time has been set on dial 4.

The maximum programmable time is 210 mins.

To turn off the buzzer, turn knob 2 clockwise until the symbol  coincides with the index of dial 4.

Note

There is no difference between automatic cooking and normal cooking.

The programmer can control the selected cooking time while you are absent or engaged in other activities.

Therefore, completely automatic cooking is most suitable for foods or dishes that require no special care.

The cooking start time can be pre-set up to a maximum of 12 hours in advance.

Using the grill

As with the oven the grill control (see Fig. 5) can be set to a number of different heat settings.

At MAX the thermostat controlling the heat does not operate and the element stays on continuously to give the highest heat possible.

Foods to be grilled are placed on the wire grid in the grill pan, which can be curved either upwards or downwards to give the required distance from the element.

The pan is then put into the ninth runner position, counting from the bottom of the oven upwards.

Important:

Because the grill is in the top of the oven, the door must be left ajar when grilling. This means that the escaping heat from the grill could overheat the control panel, so to prevent this happening it is essential that the heat deflector provided to protect the appliance is in place before the grill is switched on.

The deflector is put in place as shown in Fig. 6.

To use the grill

Open the door and put the heat deflector in position. Turn the oven control (Fig. 3) to  and then set the grill control (Fig. 5) to the heat setting required. A little use and practice will soon show which heat setting is the best for the individual user.

When grilling is over remove the heat deflector and shut the door.

General hints

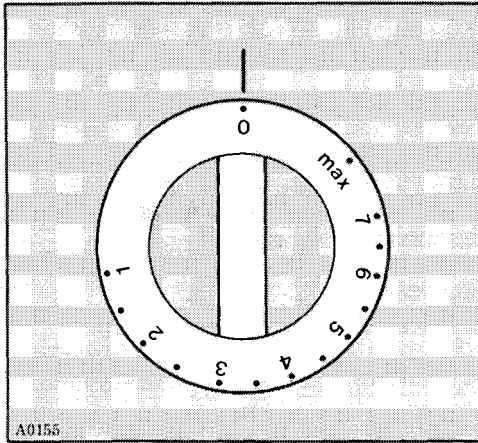

A0155

fig. 5

Use flat-bottom pots and pans which have a diameter (24-26 cm) equal to that of the electric plates (fig. 7).

Flat-bottom pots enable energy saving and increase the service life of the electric plates.

Follow instructions provided by the pots and pans manufacturer on their use. Save energy by using pots of the appropriate diameter, avoiding to select temperatures higher than those necessary and by exploiting the residual heat present on plates when they are turned off. Temperature of the electric plates may be reduced if pots and pans are provided with a cover.

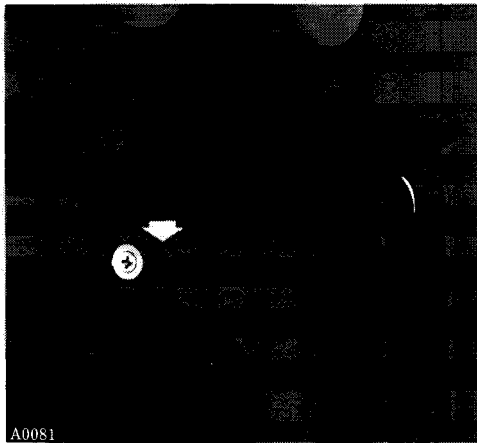

A0081

fig. 6

Hints on use of the oven and grill

In a fan oven cooking times are different and temperatures are lower than those of a conventional oven.

Pre-heating is generally not necessary in a fan oven; however when cooking meals which have a high moisture content, it may be necessary to pre-heat your oven for approx. 10 minutes at the cooking temperature to avoid condensation.

Also, when cooking meats requiring short times, pre-heating with improve the results. Dishes to be cooked must be placed on the grill, on the grill pan (roast) or on a baking-pan placed on the grill.

Whipped up kneadings have the required firmness when they tend to stick to the spoon as, otherwise, an excessive fluidity would uselessly stretch the cooking time. Shortbread kneadings should first be baked in the mould on the baking-tin for about two-thirds of the total baking time, and then be garnished (trimmed) before you complete the baking.

This final baking time depends on the type and quantity of the garniture (trimmings).

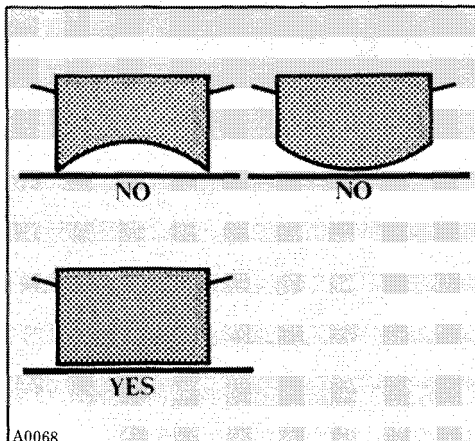

A0068

fig. 7

Gourmets greatly appreciate grilled food as it usually remains very tender and savoury. All meats are suitable for grilling, with the exception of some lean game meats and meat-loaves.

The meat must be thoroughly drained, i.e. kept until it becomes high (tender).

The pieces of meat to be cooked should not weigh less than 1 Kg. boneless.

If bones are removed beforehand, this will shorten the cooking time and it will be easier to cut the meat.

Ingredients for the gravy should be placed in the baking-tin straightaway if cooking is to be short. If cooking is to last long, instead, these ingredients are to be added during the last half-hour. To find out if the meat is done, press it down with a spoon. If it is well done the meat should not give in (yield). When the meat is done to a turn, the gravy is grayish in colour. Cooking time for roast-beef and fillet, the inside of which should remain of a pink colour, is reduced.

Wait for at least 15 minutes before cutting the meat, so that the dish gravy (meat juice) may settle down instead of dripping out profusely.

The dish can be kept warm in the oven with the thermostat turned off.

Do not open the oven door unless absolutely necessary.

Safety thermostat

This device cuts out the electricity supply in case of an appliance failure or of its improper use, and thus prevents the hazard of overheatings.

The thermostat switches on again automatically as a result of a decrease in temperature.

Therefore, if the safety thermostat cuts in due to improper appliance use (e.g. grilling with the door closed) to turn on the oven again it's sufficient to wait till it has cooled and then eliminate the cause.

If, on the other hand, the thermostat has cut in due to a component failure, contact your local Dealer.

Upkeep and cleaning

For a long service life of the appliance, we strongly recommend that you frequently carry out a thorough cleaning operation. All operations must be carried out when the appliance has cooled.

Important

Before undertaking any cleaning or upkeeping operation, be sure to have the appliance disconnected from the electric supply.

Cleaning the electric plates

Avoid discolouring of the electric plates by cleaning them after use with water and a detergent and then wipe them with a cloth soaked with a window cleaning liquid.

Never use steel wool pads since they damage the antirust coat on the electric plate and it scratches the surrounding enamel.

Electric plates which remain unused for long periods of time, such as in second houses, or which operate in salty or vapour saturated environments may become rusty.

In these cases the anti-rust coat must be renewed using the appropriate products available on the market. Do not cover a damp electric plate, since this may produce rust.

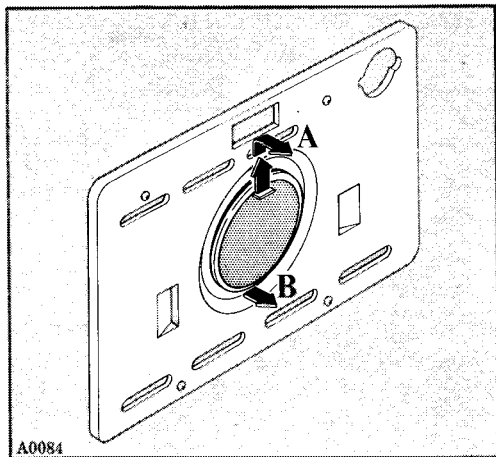

A0084

fig. 8

Cleaning the oven

Always wait until the oven is cool before cleaning.

All enamelled parts should be washed with lukewarm water and detergent without using abrasive products which might damage them.

The oven should be cleaned inside with the greatest care, after each use, with hot water and detergent (or one of the special products available on the market).

When cleaning the oven, be careful to protect the aluminium parts of the control panel from chemical compounds contained in the products used to clean the enamelled parts.

Grease filter

This filter protects the fan from fat splashes; it should always be cleaned after roasting has taken place. As it is stainless steel you can safely wash it in a dishwasher. To remove the filter operate as follows:

Case A

Press upwards the tag protruding from the filter (fig. 8) and remove the filter from the bottom panel.

Case B

Introduce your finger in the appropriate slot provided on the filter and press and pull the filter outwards (fig. 8); remove the filter from the bottom panel.

Removing the enamelled panels

Slide out the bottom drip tray, unscrew the fastening ring nuts of the side runners (fig. 9), remove the runners and pull outwards the side panels sliding them out from their pins (fig. 10).

Extract the grill element by pulling it outwards and lastly the top panel.

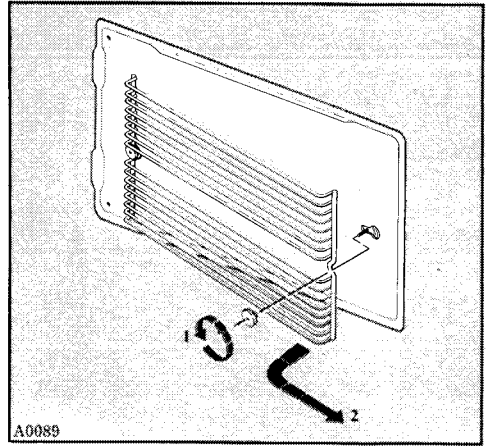

fig. 9

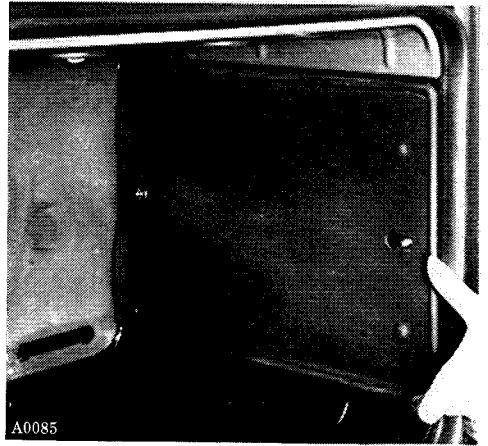

fig. 10

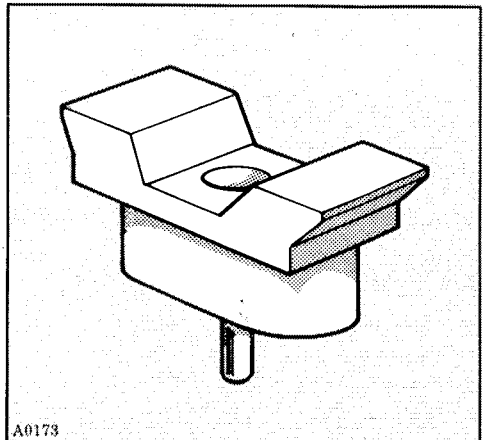
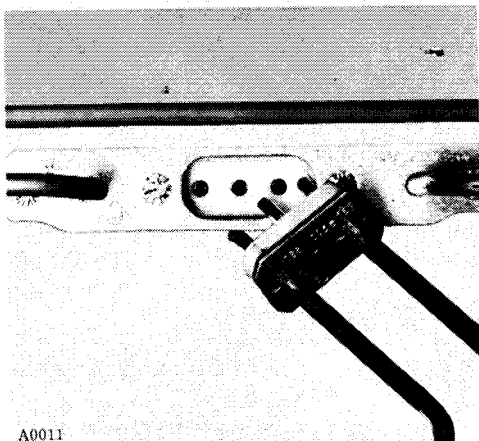

fig. 11



A0011

fig. 12

Caution: before removing the back panel make sure the oven is disconnected from the electric supply and plug into the grill socket the appropriate safety cap (fig. 11-12).

To remove the back panel use a screwdriver (fig. 13).

Take this opportunity to clean also the back side of the back panel.

If you use the spray to clean the oven do not point it towards the fan or the thermostat sensor.

Replacing the oven lightbulb (fig. 14)

Disconnect the appliance from the electric supply. Unscrew the lightbulb glass protection from the oven. Unscrew the lightbulb and replace it with a new bulb suitable for high temperature (300 °C) and having the following technical features:

Operating voltage: 240V - 50 Hz

Power absorbed: 15 W

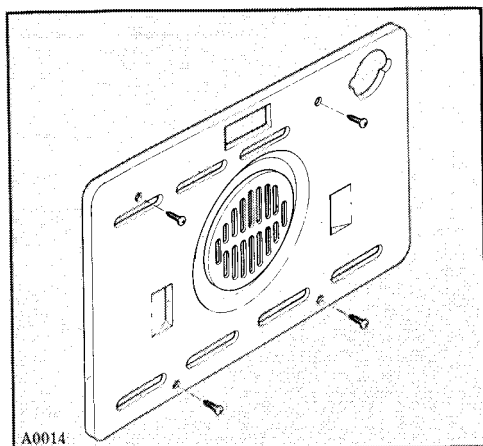

A0014

fig. 13

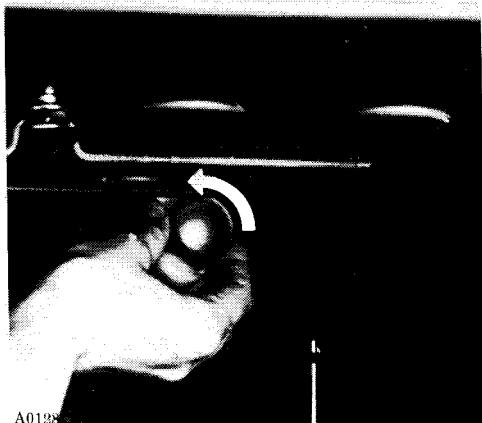

A0128

fig. 14

Removing the oven door (Fig. 15 A-B)

To thoroughly clean the oven you should remove the door by proceeding as follows:

1. With the aid of a coin, turn the oven door stops (catches) 45° to the right. See drawing 15/A.
2. Raise the door to the limit stop, press it lightly against the oven and pull it out in a forward direction. Grasp the door on the two sides - don't pull it by the handle. See drawing 15/B.

To re-install the door:

1. Insert the door into the oven with its two brackets.
2. Open the oven door and return the door stops (catches) to their original position.

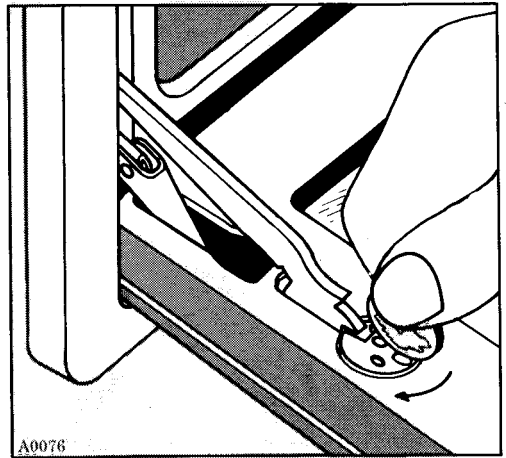

A0076

fig. 15/A

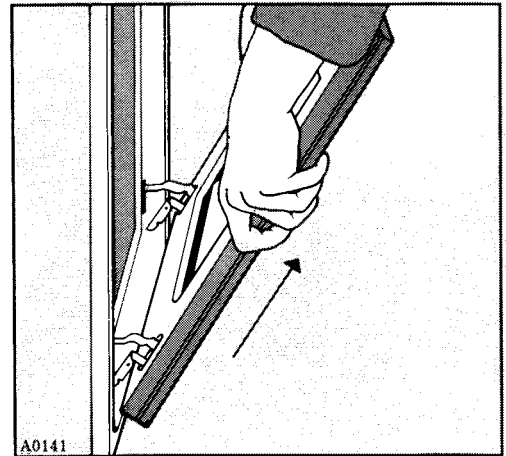

A0141

fig. 15/B

Installation

The following instructions are meant for a qualified installer and should assist him in carrying out all installation, adjustment and maintenance operations in the most correct way and in accordance with existing laws and regulations.

Important

Before servicing the appliance or undertaking any maintenance work on it, be sure to disconnect it from the electric supply. Should it be absolutely necessary to keep the appliance «live» take all possible precautions to prevent accidents.

Positioning

To ensure a troublefree operation of the appliance, it is a must that it be set up in a well ventilated kitchen (in this connection, the installer needs only comply with existing rules and regulations).

The cooker may be positioned in such a way as to come into touch with the sides of the kitchen furniture. However, the latter must be able to withstand a temperature increase of 60°C.

The appliance incorporates a removable base (A - fig. 16-17) which permits the alignment with kitchen furniture having a height of 85 cms, plus levelling feet (B - fig. 16).

To remove the metal base rest the appliance on a side, slide out the front plastic panel (C - fig. 16) which is push-fitted and then unscrew the six screws (D - fig. 16) that secure the base to the cabinet.

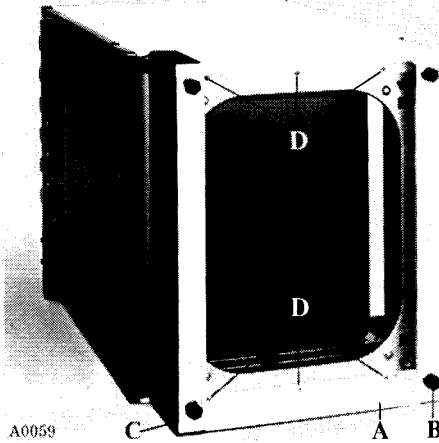

A0059
fig. 16

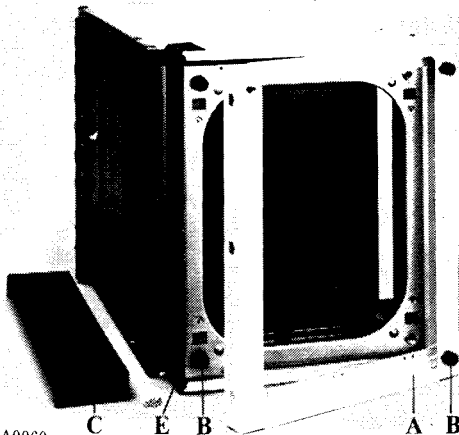

A0060
fig. 17

Remove the levelling feet from the base (B - fig. 16-17), screw them onto the cabinet and then fit the new front panel (optional) (E - fig. 17).

Position the appliance.

The appliance incorporates a set of adjustable feet.

By properly adjusting the feet, the appliance can be set up at the required height and correctly aligned with the kitchen furniture or any other surface, thus ensuring an even spreading out of liquids in pans and pots.

These adjustable feet are easily accessible after removing the dish-warming drawer.

To remove this drawer, proceed as follows:

pull out the drawer to the limit stop in order to slide out completely the side runners;

shift the front rollers up to the slots of the side runners;

lift up the drawer and slide out the front rollers;

pull out the drawer and shift the rear rollers up to the slots of the side runners;

lift up the drawer and slide out the rear rollers.

To replace the drawer, reverse the above procedure.

Electrical connection

The appliance is designed to operate on alternating current, with a single phase voltage of 240 V - 50 Hz.

The electric supply cable has to be connected to the terminal board placed under the cover on the back of the appliance.

The oven terminal board has the following markings:

L = Live

N = Neutral

⊕ = Earth

The ground wire has to be green & yellow coloured.

If you require a direct connection to the electric network (mains), it will be necessary to fit between the cooker and the mains an omnipole switch, with a minimum aperture between contacts of 3 mm, suitable to carry the required load and conforming to the ruling specifications.

The green & yellow ground wire must not be interrupted by the switch.

The supply cable must at any rate be placed in such a way as to ensure that it does not reach at any given point a temperature 50°C higher than the ambient temperature.

Prior to connecting the cooker to the electricity supply make sure that:

the protection fuse and the domestic wiring are suitable to carry the total electric load of the cooker (see rating plate);

the electricity supply network (mains) has an efficient earth connection according to the established rules and existing regulations;

with the cooker definitely installed, the wall socket or the omnipole switch can easily be reached.

The Manufacturer disclaims any liability in case these accident-preventing rules are not observed.

The heat insulation of the oven and grease residues from the manufacturing process produce smoke and an unpleasant smell during the first minutes of operation.

It is therefore advisable, the first time the appliance is used, to pre-heat the oven for about 30 mins. at peak temperature without putting any food into it.

What happens if something goes wrong

Power cuts

If the cooker does not come on when cooking manually, first check that the programmer is set for manual, i.e. in the  position.

If this is as it should be and the oven still does not come on:

check that it is plugged in properly;

check that the socket switch and/or the switch from the supply to the oven are ON;

replace the fuse in the plug, when present, with another of the appropriate rating and check that this plug has been wired up properly;

check that the socket, when present, is supplying power - do this by plugging in another appliance that is known to be working properly;

check that the fuse in the fuse box is intact.

If, after all these checks, the oven still does not work, send for your local Zanussi network service centre listed in the telephone directory.

If helps to jot down the name and address and telephone number in the space below.



ZANUSSI STANDARD GUARANTEE CONDITIONS

This guarantee is in addition to your statutory and other legal rights which will not be excluded or in any way diminished by the return of the guarantee card.

We, IAZ International (UK) Ltd, undertake that if, within twelve months (24 months for TV sets) of the date of the purchase, this ZANUSSI appliance or any part thereof is proved to be defective by reason only of faulty workmanship or materials, we will, at our option, repair or replace the same **FREE OF ANY CHARGE** for labour, materials or carriage on condition that:

—The appliance has been correctly installed and used only on the electricity supply stated on the rating plate.

—The appliance has been used for normal domestic purposes only, and in accordance with the manufacturer's operating and maintenance instructions.

—The appliance has not been serviced, maintained, repaired, taken apart or tampered with by any person not authorised by us.

—The appliance is still in the possession of the original purchaser.

All service work under this guarantee must be undertaken by a Zanussi Network Service Centre (or the Zanussi Authorised TV Service Dealer).

Any appliance or defective part replaced shall become our property.

Exclusions

This guarantee does not cover:

—Damage or calls resulting from transportation, improper use or neglect, the replacement of any light bulbs or removable parts of glass or plastic.

—Costs incurred for calls to put right machines improperly installed or calls to machines outside the UK and the Republic of Ireland.

—Appliances found to be in use within a commercial environment, plus those which are the subject of rental agreements.

—Television receivers - routine adjustment, or poor reception resulting from a source outside of the receiver.



ZANUSSI 5 YEAR COVER CONDITIONS

For a once-only payment you can extend your Standard Guarantee to 5 years. All the conditions and exclusions of the Standard Guarantee apply.

Notes

1. Products supplied as "seconds", refurbished, damaged or shop-soiled are not eligible for Zanussi 5 year cover.
2. The issue of a cover does NOT by virtue of our having done so, nullify the exclusions.
3. The Engineer will need to check the details of your Cover card and may make a charge for his services if it is not presented to him at the time of his call.
4. The date of purchase, or the date of initial payment (deposit) of the appliance will be deemed the date of commencement of cover.
5. Covers issued are not refundable or transferable.

ZANUSSI
The appliance of science

Free Manuals Download Website

<http://myh66.com>

<http://usermanuals.us>

<http://www.somanuals.com>

<http://www.4manuals.cc>

<http://www.manual-lib.com>

<http://www.404manual.com>

<http://www.luxmanual.com>

<http://aubethermostatmanual.com>

Golf course search by state

<http://golfingnear.com>

Email search by domain

<http://emailbydomain.com>

Auto manuals search

<http://auto.somanuals.com>

TV manuals search

<http://tv.somanuals.com>