

**ZANUSSI**

---

# **Instructions for the use and care of GC 20 M cooker**

# Contents

## Instructions for the owner

Installation . . . . .	Page 3
Technical data . . . . .	Page 3
Use . . . . .	Page 4
Gas oven . . . . .	Page 6
Using the rotisserie . . . . .	Page 8
Minute minder . . . . .	Page 8
Cooking procedure . . . . .	Page 9
Maintenance & cleaning . . . . .	Page 10

## Instructions for the installer

Installation . . . . .	Page 12
Gas connection . . . . .	Page 14
Electrical connection . . . . .	Page 14
Replacing the nozzles . . . . .	Page 15
Adjusting the air . . . . .	Page 18
Adjusting the minimum . . . . .	Page 18
Maintenance. . . . .	Page 19

---

### Caution:

Before you start operating the appliance, be sure to remove the plastic films protecting the stainless steel or anodized aluminium parts.

**Important:** During normal cooking operations the appliance will get very hot. Therefore, do not let children play near the appliance.

# Instructions for the owner

## Installation

It is mandatory that all operations required for the installation, the adjustments, the conversion to the type of gas available etc. be carried out by QUALIFIED PERSONNEL in accordance with existing rules and regulations.

The relevant instructions are to be found in the special chapter for the installer.

This appliance meets the requirements laid down in EEC Directive No 82/499 dated 7/6/1982 relating to the suppression of radio and TV interference.

## Technical data

Model	GC 20 M
Dimensions: height	900 mm
depth	598 mm
width	597 mm
Oven volume	53 dm <sup>3</sup>
Automatic lighting: worktop	YES
oven and grill	YES
Safety (Thermocouple): oven and grill	YES
Roasting jack: multiple rotisserie	YES
Oven lamp	YES
Mechanical minute minder	YES
Supply voltage (240V - 50Hz)	YES

# Care and use

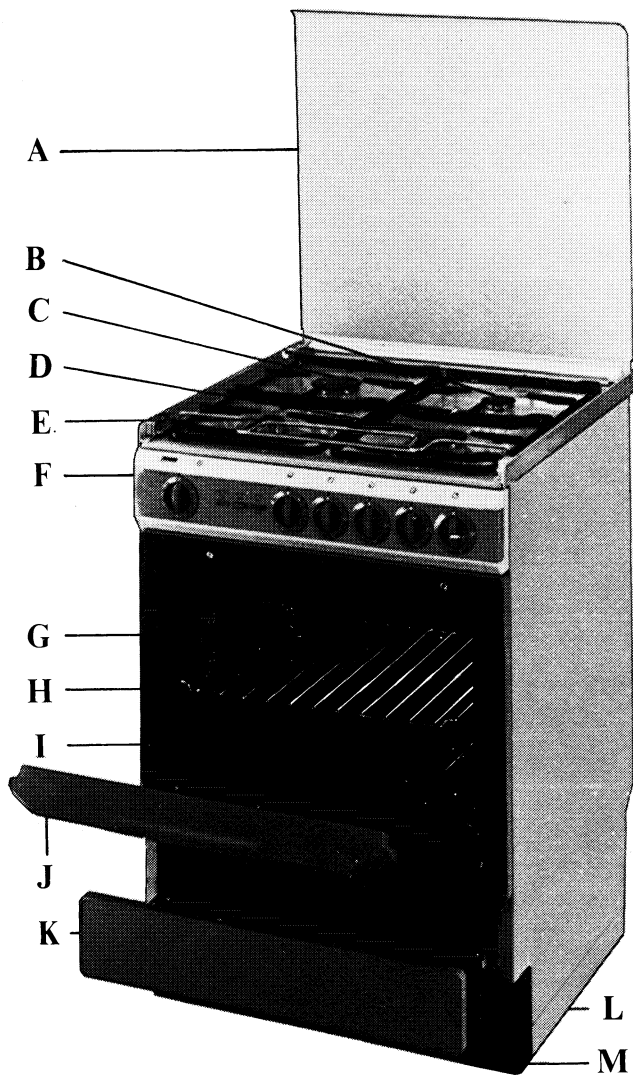

## Cooker

A - Cover  
B - Semi-rapid burner  
C - Rapid Burner  
D - Rapid burner  
E - Auxiliary burner  
F - Control panel

G - Side grilles  
H - Grilles  
I - Dripping pan  
J - Oven door  
K - Removable drawer  
L - Removable base  
M - Front panel

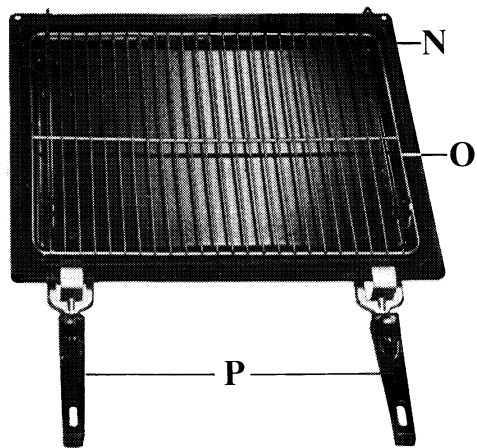

N - Grill or roasting pan  
 O - Reversible grill pan insert  
 P - Removable handles (2 Off.)

## Control panel

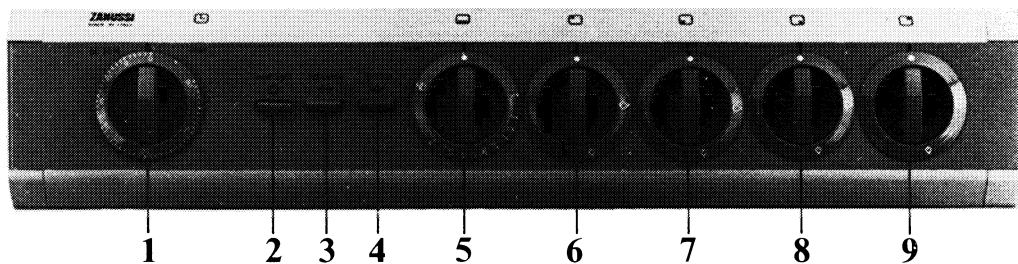

1. Minute minder
2. Oven light switch
3. Rotisserie switch
4. Lighting button
5. Oven knob

6. Rapid burner knob
7. Auxiliary burner knob
8. Rapid burner knob
9. Semi-rapid burner knob

# Operation

## Worktop burners

To light a worktop burner, turn the relevant knob anticlockwise to maximum (Fig. 1).

After opening the tap to maximum, push button marked by a small electric spark. As soon as the burner is lit, adjust the flame as required.

To ensure maximum burner efficiency, it is strongly recommended that you use only pots and pans with a bottom fitting the size of the burner used, so that the flame will not spread beyond the bottom of the vessel.

It is also advisable, as soon as a liquid starts boiling, to turn down the flame so that it will barely keep the liquid simmering.

**Important:** Be very careful when frying food in hot oil or fat as the overheated splashes could easily flare up.

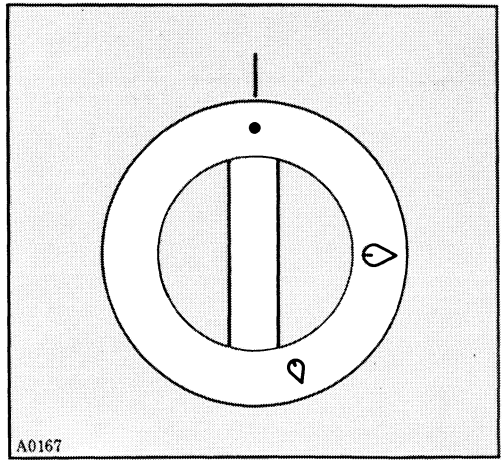

A0167

Fig. 1

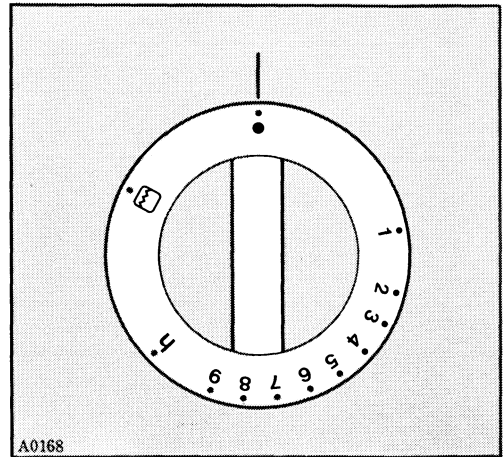

A0168

Fig. 2

## Gas oven

The oven features an enamelled dripping-pan to collect the gravy when grilling or spit-roasting meat, and a shelf to grill food or to cook it in baking-tin.

Furthermore this oven fits a device which makes the ignition of the burner easier. The instructions are the following:

1. Open the oven door.
  2. Firmly depress the oven control knob (fig. 2) and turn it anticlockwise to the maximum setting and at the same time operate on the relevant pushbutton marked by a small electric spark. Keep the oven control knob depressed for 10-15 secs.
  3. Release the control knob and then gently close the oven door.
- To adjust the temperature, after a few minutes turn the knob to the required temperature setting.

## Oven temperature chart

Position	Temperatures	
	°F	°C
1	275	135
2	300	149
3	325	163
4	350	177
5	375	191
6	400	204
7	425	218
8	450	232
9	475	246
h	527-356	275-280

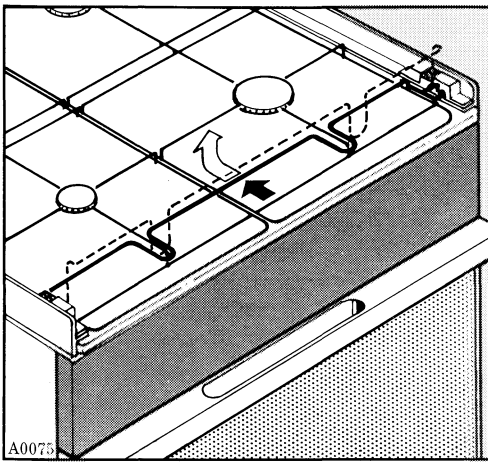

A0075

Fig. 3

## Gas grill

To light the grill, firmly depress the oven control knob and turn it clockwise to the symbol , then operate on the pushbutton marked by a small spark. Keep the control knob depressed for 10-15 secs; then release the grill control knob.

## Oven safety device

The cooker features a thermocouple; if for any reason the flame should extinguish the device will interrupt the gas flow.

### Important:

Oven and grill burner lighting is possible only if the oven door is open.

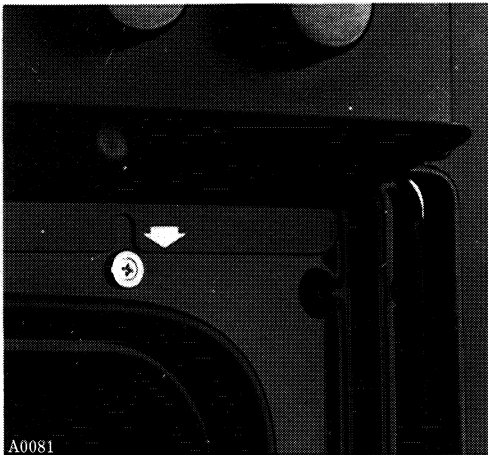

A0081

Fig. 4

## Pot safeguard (Fig. 3)

A particular joint system allows to fix the pot guard in its vertical working position and in the horizontal (resting) position as well.

To lift the pot guard: push forwards and rotate it at the same time.

To lower it: lift upwards and rotate it reversely.

## Oven light switch

This switch will turn on the oven light.

## Using the grill

Foods to be grilled are to be placed on the wire grid in the grill pan which can be curved either upwards or downwards to give the required distance from the burner.

The pan is then placed in the required runner position.

**Important:** Because the grill is in the top of the oven, the door must be left ajar when grilling. This means that the escaping heat from the grill could overheat the control panel, so to prevent this happening it is essential that the

heat deflector provided to protect the appliance is in place before the grill is turned on.

The deflector is put in place as shown in Fig. 4.

## Using the rotisserie

The rotisserie can be used for either spit roasting meat or for kebabs and smaller pieces of meat. The accessories for either are provided.

If you want to spit roast a large piece of meat or poultry proceed as follows:

Firstly place one of the two prong forks onto the spit and lock it into position with the thumb nut. Then skewer the meat or poultry onto the spit and secure onto the fork.

Place the second fork onto the spit and skewer it into the meat then lock it in position with the thumb nut.

Place the spit onto the support frame and ensure it turns freely and evenly.

If it does not, reposition the meat until it does otherwise excessive wear to the motor will result.

Place the frame and spit into the oven so the spit engages fully into the motor in the back of the oven and depress the rotisserie switch.

Should you wish to use the kebab attachments then proceed as follows:

Firstly place one of the support discs with 4 elongated slots in it onto the spit and secure it by locking the thumb nut about 1½ inches from the handle of the spit.

Next place the disc with the 8 holes onto the spit and secure it in position with the thumb nut. The position of this disc can be decided by judging the distance required against the length of the individual kebab skewers.

Next place the third disc on the skewer positioning it at an equal distance from the centre disc as the first one.

Lock it in position with the thumb nut.

Prepare the 8 individual kebab skewers and putting the pointed end through one of the holes on the centre disc.

Lock it in position by placing the other end in an elongated slot in one of the outer discs and turning it.

Repeat this operation for each of the 8 skewers.

Place the spit onto the frame and check that it turns freely and evenly.

If it does not, reposition the weight of the food until it does.

If this is not done excessive wear to the motor will result.

Place the frame and spit into the oven so that the spit engages fully into the motor in the back of the oven.

Place a drip pan on a lower support.

Secure the heat deflector into its position, close the oven door to the ajar position and depress the rotisserie switch.

## Mechanical minute minder (Fig. 5)

The minute minder can be set for any time interval up to one hour.

The control knob should first be turned clockwise to 60 minutes and then reversed to the required time interval.

When cooking time is up the alarm clock rings and then stops by itself.

However, the alarm clock will not turn off the oven when it rings.

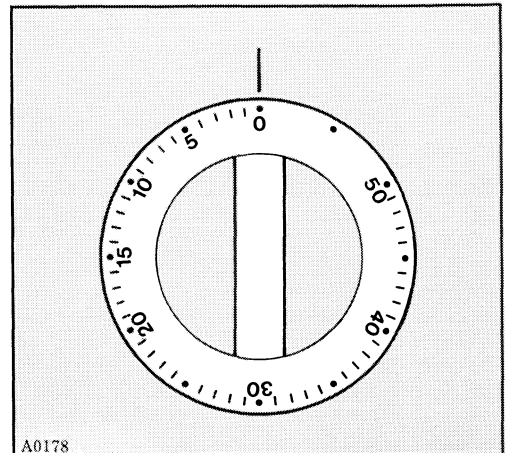

Fig. 5



# Hints for a correct use of the oven and the grill

After turning on the oven and prior to introducing the food, it is advisable to wait for about 10 to 15 minutes to allow the oven to reach the required temperature. In the case of dishes requiring a high initial temperature or a stabilized temperature at the centre of the oven, the above preheating time will have to be increased.

The food to be cooked should be placed on the oven shelf, dripping-pan (roast meat) or in a baking-tin placed on the shelf. To obtain a uniform cooking, it is advisable to use the oven lower or middle runner.

Experience will tell which is the most suitable position in each case depending on the cooking requirements.

The oven wire grid can be curved either upwards or downwards to give the required distance from the burner.

Whipped up kneadings have the required firmness when they tend to stick to the spoon as, otherwise, an excessive fluidity would uselessly stretch the cooking time. Shortbread kneadings should first be baked in the mould on the baking-tin for about two-thirds of the total baking time, and then be garnished (trimmed) before you complete the baking.

This final baking time depends on the type and quantity of the garniture (trimmings). Gourmets greatly appreciate grilled food as it usually remains very tender and savoury. All meats are suitable for grilling, with the exception of some lean game meats and meat-loaves.

The meat must be thoroughly drained, i.e. kept until it becomes high (tender).

The pieces of meat to be cooked should not weigh less than 1 Kg. boneless.

If bones are removed beforehand, this will shorten the cooking time and it will be easier to cut the meat. Meat needs to be turned over only if cooking is done at higher temperatures.

Ingredients for the gravy should be placed in the baking-tin straightaway if cooking is to be short. If cooking is to last long, instead, these ingredients are to be added during the last half-hour.

To find out if the meat is done, press it down with a spoon.

If it is well done the meat should not give in (yield). When the meat is done to a turn, the gravy is grayish in colour. Cooking time for roast-beef and fillet, the inside of which should remain of a pink colour, is reduced.

Wait for at least 15 minutes before cutting the meat, so that the dish gravy (meat juice) may settle down instead of dripping out profusely.

The dish can be kept warm in the oven with the burner turned off.

# Maintenance

For a long service life of the appliance we strongly recommend that you frequently carry out a thorough cleaning operation.

## Cleaning the oven

Always wait until the oven is cool before cleaning.

All enamelled parts should be washed with lukewarm water and detergent without using abrasive products which might damage them.

The oven should be cleaned inside with the greatest care, after each use, with hot water and detergent (or one of the special products available on the market).

When cleaning the oven, be careful to protect the aluminium parts of the control panel from chemical compounds contained in the products used to clean the enamelled parts.

## Removing the panels

Unscrew the ring nuts securing the side grilles (Fig. 6), remove the grilles and then remove the side panels (Fig. 7).

## Cleaning the worktop

Burner caps should be frequently washed in hot water and detergent, being careful to remove all incrustations.

Thoroughly clean the terminal part of the automatic lighting device, to prevent a difficult lighting and, furthermore, make sure that the flame spreader gas openings are unobstructed.

Stainless steel parts should be carefully rinsed with water, after each use, and then dried with a clean soft cloth or with a buckskin.

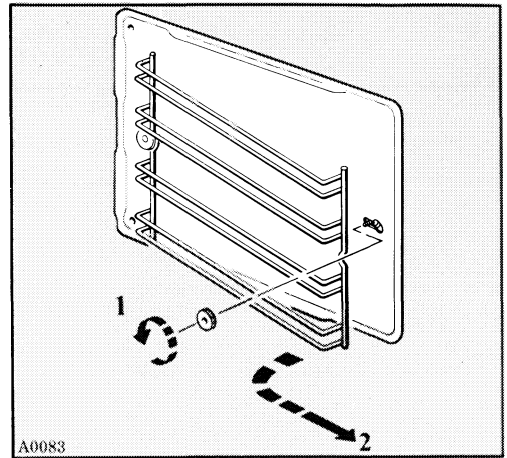

A0083

Fig. 6

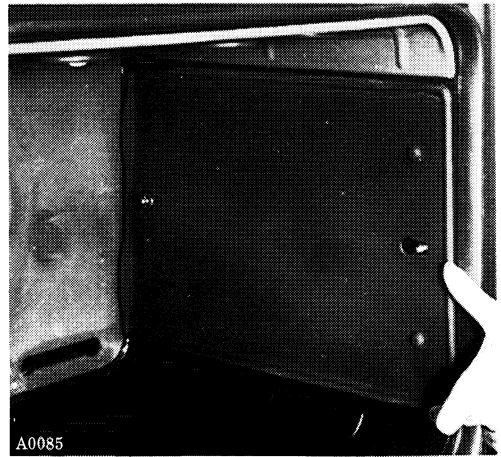

A0085

Fig. 7

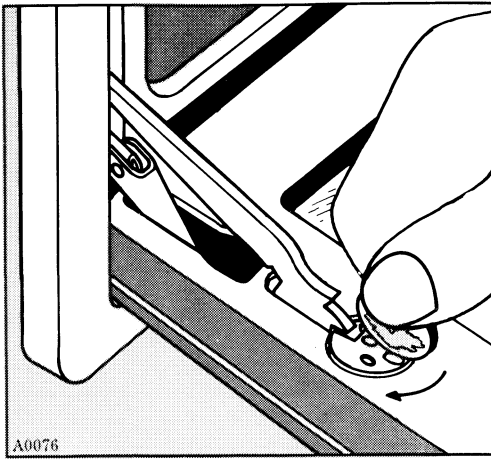

A0076

fig. 8/A

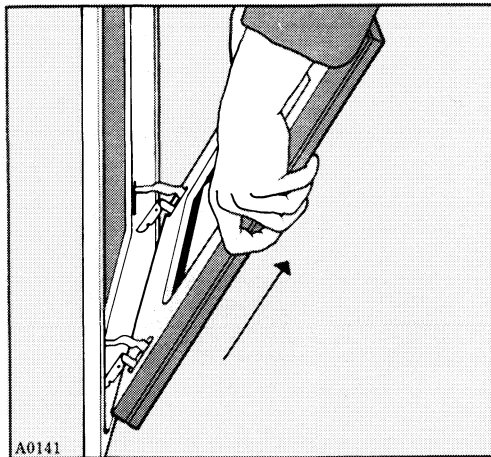

A0141

fig. 8/B

In the case of persistent spots you may use normal non-abrasive detergents, currently available on the market, or some hot vinegar.

Never use steel-wool pads, chlorine or similar products which might scratch, grind or etch the metal.

Also, never close the cover while the burners are still warm.

## Replacing the oven lightbulb

Disconnect the appliance from the electric supply.

Unscrew the lightbulb glass protection from the oven. Unscrew the lightbulb and replace it with a new bulb suitable for high temperature (300 °C) and having the following technical features:

Operating voltage: 240V - 50 Hz

Power absorbed: 15 W

## Removing the oven door

(Fig. 8 A-B)

To thoroughly clean the oven you should remove the door by proceeding as follows:

**1.**

With the aid of a coin, turn the oven door stops (catches) 45° to the right.

See drawing A.

**2.**

Raise the door to the limit stop, press it lightly against the oven and pull it out in a forward direction.

Grasp the door on the two sides- don't pull it by the handle. See drawing B.

# Instructions for the installer

## Installation

The following instructions are meant for a qualified installer and should assist him in carrying out all installation, adjustment and maintenance operations in the most correct way and in accordance with existing laws and regulations.

### Important:

Before servicing the appliance or undertaking any maintenance work on it, be sure to disconnect it from the electric supply. Should it be absolutely necessary to keep the appliance 'live' take all possible precautions to prevent accidents.

### Positioning

To ensure a troublefree operation of the appliance, it is a must that it be set up in a well ventilated kitchen (in this connection, the installer needs only comply with existing rules and regulations).

The cooker can be positioned in such a way as to come into touch with the sides of the kitchen furniture. However, the latter must be able to withstand a temperature increase of 60 °C.

The appliance incorporates a removable base (A - Fig. 9-10) which permits the alignment with kitchen furniture having a height of 85 cms, plus levelling feet (B - Fig. 9).

To remove the metal base rest the appliance on a side, slide out the front plastic panel (C - Fig. 9) which is push-fitted and then unscrew the six screws (D - Fig. 9) that secure the base to the cabinet.

Remove the levelling feet from the base (B - Fig. 9-10), screw them onto the cabinet and then fit the new front panel (optional) (E - Fig. 10).

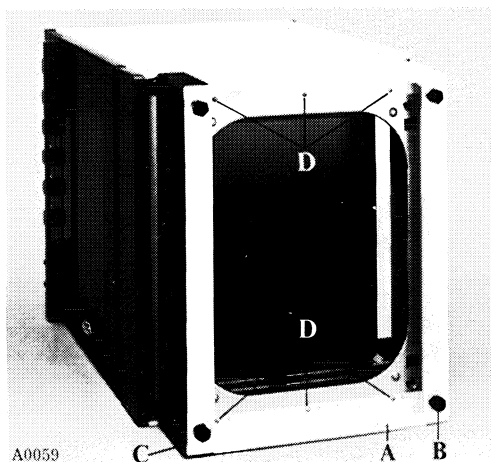

A0059  
Fig. 9

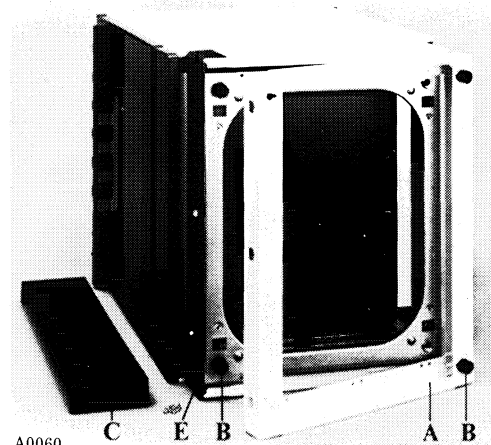

A0060  
Fig. 10

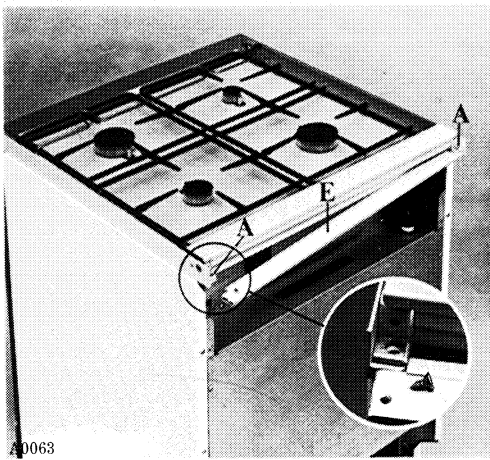

A0063  
Fig. 11

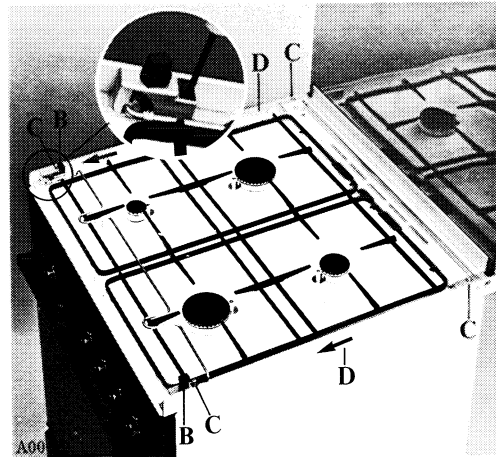

A009  
Fig. 12

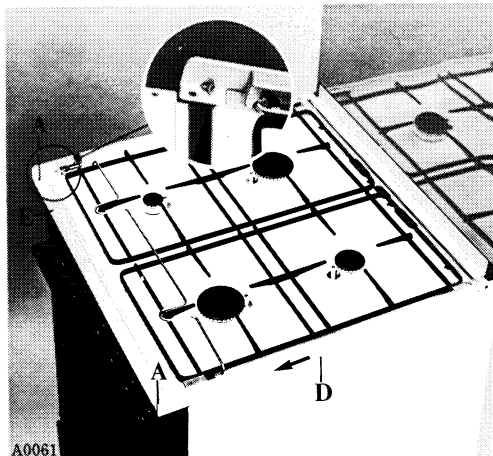

A0061  
Fig. 13

Position the appliance.

The appliance incorporates a set of adjustable feet.

By properly adjusting the feet, the appliance can be set up at the required height and correctly aligned with the kitchen furniture or any other surface, thus ensuring an even spreading out of liquids in pans and pots.

These adjustable feet are easily accessible after removing the dish-warming drawer. To remove this drawer, proceed as follows:

pull out the drawer to the limit stop in order to slide out completely the side runners;

shift the front rollers up to the "buttonholes" of the side runners;

lift up the drawer and slide out the front rollers;

pull out the drawer and shift the rear rollers up to the "buttonholes" of the side runners;

lift up the drawer and slide out the rear rollers;

To replace the drawer, reverse the above procedure.

### Alignment of the worktop

To allow the alignment with the kitchen unit, the worktop frames are removable: Remove the two screws (A - Fig. 11) fixing the gasket (E - Fig. 11) placed on the back of the worktop and then slide out the gasket;

Remove the two cover shock absorbers (B - Fig. 12);

Loosen the four screws (C - Fig. 12) fixing the side frames (D - Fig. 12) to the worktop;

Slide forward the two side frames (D - Fig. 12);

Block the side frames (D - Fig. 12) by means of the four screws (C - Fig. 12) to the worktop;

Refit the cover shock absorbers (B - Fig. 12);

Fit the gasket (E - Fig. 13) on the front side of the worktop and fix it by means of the two screws (A - Fig. 13).

# Gas connection

Connect the cooker to the gas bottle or gas mains, in accordance with existing rules and regulations, only after making sure that the appliance has been duly adapted to the type of gas available. Otherwise, carry out all operations according to the directions to be found under the paragraph "Conversion to other types of gas".

**Important:** To ensure a safe operation, a lower consumption and a longer service life of the appliance, make sure that the feed pressure is in accordance with the specifications given in the "burner and nozzle features" chart.

## Stiff connection

In case of connection to the gas mains by means of a metal pipe & fittings, make sure that this does not put any strain on the appliance.  
The cooker has a ½" threaded gas inlet.

# Electrical connection

The appliance features a three-pole electric supply cable, having a plug with fuse, and is designed to operate on alternating current, with a single phase voltage of 240 V - 50 Hz.  
The ground wire is green & yellow coloured.

The oven features an easily accessible terminal board with the following markings:

L = Live    N = Neutral     $\perp$  = Earth

## Connecting the supply cable to the mains

Insert the plug into a standard wall socket suitable for the load shown on the rating plate.

If you require a direct connection to the electric network (mains), it will be necessary to fit between the cooker and the mains an omnipole switch, with a minimum aperture between contacts of 3 mm, suitable to carry the required load and conforming to the ruling specifications.

The green & yellow ground wire must not be interrupted by the switch.

The supply cable must at any rate be placed in such a way as to ensure that it does not reach at any given point a temperature 50 °C higher than the ambient temperature.

Prior to connecting the cooker to the electricity supply make sure that:

the protection fuse and the domestic wiring are suitable to carry the total electric load of the cooker (see rating plate):

the electricity supply network (mains) has an efficient earth connection according to the established rules and existing regulations;

with the cooker definitely installed, the wall socket or the omnipole switch can easily be reached.

The Manufacturer disclaims any liability in case these accident-preventing rules are not observed.

The heat insulation of the oven and grease residues from the manufacturing process produce smoke and an unpleasant smell during the first minutes of operation.

It is therefore advisable, the first time the appliance is used, to pre-heat the oven for about 30 mins. at peak temperature without putting any food into it.

## Conversion to other types of gas

**Attention:** The cooker is adjusted for NATURAL GAS (METHANE).

To adapt the cooker to a type of gas different from the one for which it is adjusted, perform the following operations in the order.

### Replacing the nozzles (see chart)

Remove the pot-rests and the burners; undo the screws securing the worktop, lift it up (to keep it raised, use the special supporting rod located on the mounting of the left-hand burners), unscrew the nozzles and replace them with the corresponding nozzles (supplied with the cooker) suitable for the new type of gas.

Refit the parts reversing the above procedure.

## Burner and Nozzle Features Chart

Burner	Nominal Power		Liquid gas		Natural gas (Methane)	
	kC	kW	Nozzle	g/h	Nozzle	l/h 15 °C
Small (dia. 35 mm)	700	0,8	47	59	65	77
Medium (dia. 50 mm)	1400	1,6	63	118	86	155
Big (dia. 75 mm)	2600	3,0	85	219	117	288
Oven	2600	3,0	85	219	125	288
Grill	2500	2,9	85	211	125	277
Feed Pressure	nom. (mbar)*		28		20	
	min. (mbar)*		20		18	
	max. (mbar)*		35		25	

\* 1 mbar = 10 mm water column

## Taps

Burner	Dia. Tap By-Pass	Tap colour
Small	30	Red
Medium	32	Yellow
Big	42	Black

## Oven Thermostat

By-pass Pin Dia.	Liquid gas	Natural gas
	0,47	0,70



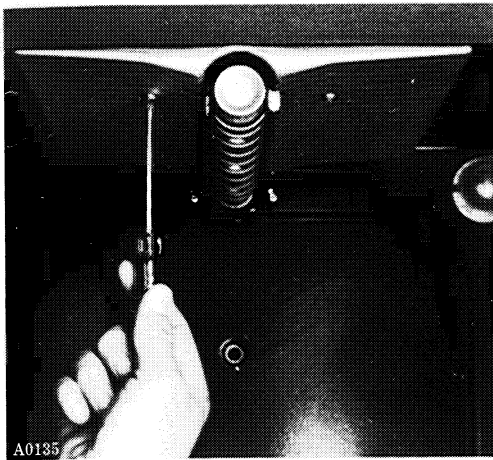

A0135  
Fig. 14

### **Oven burner**

Undo the securing screw and remove the oven bottom; from inside the dish-warming drawer unscrew the wing nut securing the bracket carrying the spark plug and the thermocouple as well as the one to be found in the front part of the burner; then push the burner itself forwards. Unscrew the nozzle and replace it with the corresponding new nozzle. Refit the parts reversing the above procedure.

### **Grill burner**

Unscrew the two screws locking the burner to the bracket (Fig. 14), then remove the burner by lowering it and pulling it forward.

Unscrew the nozzle and replace it with the corresponding new nozzle. Refit the burner reversing the above procedure.

### **Oven thermostat**

Remove the control knob and replace the by-pass pin fitted on the top of the knob shaft with the corresponding one suitable for the new type of gas.

# Adjustments

## Adjusting the primary air

Light the burners and check the flame. If the primary air needs to be adjusted, set the sliding sheet-iron ring to be found at the entrance of the burner's Venturi tube. By adjusting this ring it is possible to obtain a steady flame with a correct air-gas mixture (see Fig. 15 a/b/c).

## Adjusting the minimum flame setting

### Worktop burners

Turn the gas tap to minimum, remove the control knob and with a screwdriver turn the adjusting screw, which is inside the gas tap shaft, until a small and steady flame is obtained. Check stability of flame by quickly turning the tap from max. to min., re-adjusting the flame if necessary.

**Attention:** If the cooker is adjusted for Methane gas, to convert it to Liquid gas it will suffice to screw completely in the minimum adjustment screw, after changing the main jets.

### Oven burner

After keeping the oven in operation for about 10 minutes on the max. setting with the oven door closed, turn the thermostat to position 1, remove the control knob and then adjust the screw on top of the control knob shaft until a steady flame of the right size is obtained.

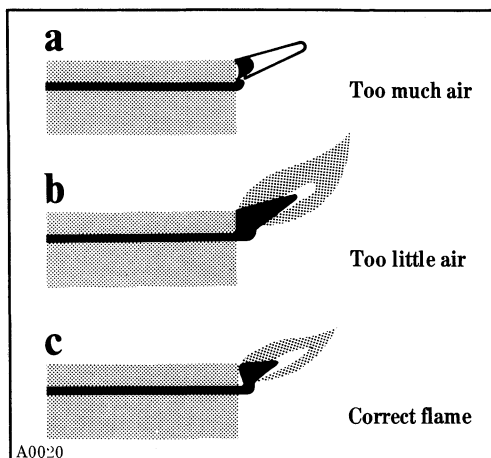

A0020

Fig. 15

# Maintenance

Check at regular intervals the condition and serviceability of the gas connection hose and pressure regulator, if any; in case of malfunction, do not repair but replace the whole faulty part.

To ensure a smooth and safe operation, it is necessary to periodically grease the gas taps.

Servicing should be carried out as follows: remove the knobs and slide out the front panel after removing the securing screws. Unscrew the two screws to be found next to the gas tap shaft.

Slide out the cone and clean it thoroughly; finally, apply a thin layer of grease of a type non-soluble to hydrocarbons and suitable for gas taps.

Make sure that no excess grease obstructs the gas tap holes.

Refit everything very carefully reversing the above procedure.



## ZANUSSI STANDARD GUARANTEE CONDITIONS

This guarantee is in addition to your statutory and other legal rights which will not be excluded or in any way diminished by the return of the guarantee card.

We, IAZ International (UK) Ltd, undertake that if, within twelve months (24 months for TV sets) of the date of the purchase, this ZANUSSI appliance or any part thereof is proved to be defective by reason only of faulty workmanship or materials, we will, at our option, repair or replace the same **FREE OF ANY CHARGE** for labour, materials or carriage on condition that:

—The appliance has been correctly installed and used only on the electricity supply stated on the rating plate.

—The appliance has been used for normal domestic purposes only, and in accordance with the manufacturer's operating and maintenance instructions.

—The appliance has not been serviced, maintained, repaired, taken apart or tampered with by any person not authorised by us.

—The appliance is still in the possession of the original purchaser.

All service work under this guarantee must be undertaken by a Zanussi Network Service Centre (or the Zanussi Authorised TV Service Dealer).

Any appliance or defective part replaced shall become our property.

### Exclusions

This guarantee does not cover:

—Damage or calls resulting from transportation, improper use or neglect, the replacement of any light bulbs or removable parts of glass or plastic.

—Costs incurred for calls to put right machines improperly installed or calls to machines outside the UK and the Republic of Ireland.

—Appliances found to be in use within a commercial environment, plus those which are the subject of rental agreements.

—Television receivers - routine adjustment, or poor reception resulting from a source outside of the receiver.



## ZANUSSI 5 YEAR COVER CONDITIONS

For a once-only payment you can extend your Standard Guarantee to 5 years. All the conditions and exclusions of the Standard Guarantee apply.

### Notes

1. Products supplied as "seconds", refurbished, damaged or shop-soiled are not eligible for Zanussi 5 year cover.

2. The issue of a cover does NOT by virtue of our having done so, nullify the exclusions.

3. The Engineer will need to check the details of your Cover card and may make a charge for his services if it is not presented to him at the time of his call.

4. The date of purchase, or the date of initial payment (deposit) of the appliance will be deemed the date of commencement of cover.

5. Covers issued are not refundable or transferable.

# ZANUSSI

The appliance of science

## Free Manuals Download Website

<http://myh66.com>

<http://usermanuals.us>

<http://www.somanuals.com>

<http://www.4manuals.cc>

<http://www.manual-lib.com>

<http://www.404manual.com>

<http://www.luxmanual.com>

<http://aubethermostatmanual.com>

Golf course search by state

<http://golfingnear.com>

Email search by domain

<http://emailbydomain.com>

Auto manuals search

<http://auto.somanuals.com>

TV manuals search

<http://tv.somanuals.com>